

SERVICE MANUAL

Series PLFY Ceiling Cassettes R454B

Indoor unit

[Model Name]
PLFY-L05NFMU-A

[Service Ref.]

PLFY-L05NFMU-A

PLFY-L08NFMU-A

PLFY-L08NFMU-A

PLFY-L12NFMU-A

PLFY-L12NFMU-A

PLFY-L15NFMU-A

PLFY-L15NFMU-A

PLFY-L18NFMU-A

PLFY-L18NFMU-A

Grille model

[Model Name]
SLP-18FAU

SLP-18FAEU

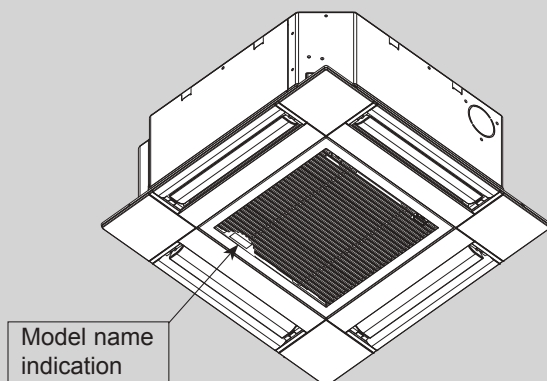

INDOOR UNIT

CONTENTS

1. SAFETY PRECAUTION.....	2
2. PARTS NAMES AND FUNCTIONS.....	7
3. SPECIFICATIONS.....	8
4. 4-WAY AIR FLOW SYSTEM.....	11
5. OUTLINES AND DIMENSIONS.....	13
6. WIRING DIAGRAM.....	14
7. REFRIGERANT SYSTEM DIAGRAM.....	15
8. MICROPROCESSOR CONTROL.....	15
9. TROUBLESHOOTING.....	22
10. DISASSEMBLY PROCEDURE.....	33
11. REMOTE CONTROLLER.....	39





PARTS CATALOG (OCB862)

CITY MULTI

1

SAFETY PRECAUTION

MEANINGS OF SYMBOLS DISPLAYED ON THE UNIT

	WARNING (Risk of fire)	This unit uses a flammable refrigerant. If the refrigerant leaks and comes in contact with fire or a heating part, it will create a harmful gas and there is risk of fire.
	Read the OPERATION MANUAL carefully before operation.	
	Service personnel are required to carefully read the OPERATION MANUAL and INSTALLATION MANUAL before operation.	
	Further information is available in the OPERATION MANUAL, INSTALLATION MANUAL, and the like.	

1-1. ALWAYS OBSERVE FOR SAFETY

Before obtaining access to terminal, all supply circuits must be disconnected.

1-2. CAUTIONS RELATED TO NEW REFRIGERANT

Cautions for units utilizing refrigerant R454B

Do not use the existing refrigerant piping.

The old refrigerant and lubricant in the existing piping contains a large amount of chlorine which may cause the lubricant deterioration of the new unit.

Make sure that the inside and outside of refrigerant piping is clean and it has no contaminants such as sulfur, oxides, dirt, shaving particles, etc., which are hazard to refrigerant cycle. In addition, use pipes with specified thickness.

Contamination inside refrigerant piping can cause deterioration of refrigerant oil, etc.

Store the piping indoors, and keep both ends of the piping sealed until just before brazing. (Leave elbow joints, etc. in their packaging.)

If dirt, dust or moisture enters into refrigerant cycle, that can cause deterioration of refrigerant oil or malfunction of compressor.

The refrigerant oil applied to flare and flange connections must be ester oil, ether oil or alkylbenzene oil in a small amount.

If large amount of mineral oil enters, that can cause deterioration of refrigerant oil, etc.

Charge refrigerant from liquid phase of gas cylinder.

If the refrigerant is charged from gas phase, composition change may occur in refrigerant and the efficiency will be lowered.

Ventilate the room if refrigerant leaks during operation. If refrigerant comes into contact with a flame, poisonous gases will be released.

Use a vacuum pump with a reverse flow check valve.

Vacuum pump oil may flow back into refrigerant cycle and that can cause deterioration of refrigerant oil, etc.

Use the following tools specifically designed for use with R454B refrigerant.

The following tools are necessary to use R454B refrigerant.

Tools for R454B	
Gauge manifold	Flare tool
Charge hose	Size adjustment gauge
Gas leak detector	Vacuum pump adaptor
Torque wrench	Electronic refrigerant charging scale

Handle tools with care.

If dirt, dust or moisture enters into refrigerant cycle, that can cause deterioration of refrigerant oil or malfunction of compressor.

Do not use a charging cylinder.

If a charging cylinder is used, the composition of refrigerant will change and the efficiency will be lowered.

Use the specified refrigerant only.

Never use any refrigerant other than that specified. Doing so may cause a burst, an explosion, or fire when the unit is being used, serviced, or disposed of. Correct refrigerant is specified on name plate of outdoor unit.

If other refrigerant (R22, etc.) is used, chlorine in refrigerant can cause deterioration of refrigerant oil, etc. We will not be held responsible for mechanical failure, system malfunction, unit breakdown or accidents caused by failure to follow the instructions.

[1] Warning for service

- (1) Do not alter the unit.
- (2) For installation and relocation work, follow the instructions in the Installation Manual and use tools and pipe components specifically made for use with refrigerant specified in the outdoor unit installation manual.
- (3) Ask a dealer or an authorized technician to install, relocate and repair the unit.
- (4) This unit should be installed in rooms which exceed the floor space specified in outdoor unit installation manual. Refer to outdoor unit installation manual.
- (5) Install the indoor unit at least 2.5 m above floor or grade level.
For appliances not accessible to the general public.
- (6) Refrigerant pipes connection shall be accessible for maintenance purposes.
- (7) If the air conditioner is installed in a small room or closed room, measures must be taken to prevent the refrigerant concentration in the room from exceeding the safety limit in the event of refrigerant leakage. Should the refrigerant leak and cause the concentration limit to be exceeded, hazards due to lack of oxygen in the room may result.
- (8) Keep gas-burning appliances, electric heaters, and other fire sources (ignition sources) away from the location where installation, repair, and other air conditioner work will be performed.
If refrigerant comes into contact with a flame, poisonous gases will be released.
- (9) When installing or relocating, or servicing the air conditioner, use only the specified refrigerant written on outdoor unit to charge the refrigerant lines.
Do not mix it with any other refrigerant and do not allow air to remain in the lines.
If air is mixed with the refrigerant, then it can be the cause of abnormal high pressure in the refrigerant line, and may result in an explosion and other hazards.
- (10) After installation has been completed, check for refrigerant leaks. If refrigerant leaks into the room and comes into contact with the flame of a heater or portable cooking range, poisonous gases will be released.
- (11) Do not use low temperature solder alloy in case of brazing the refrigerant pipes.
- (12) When performing brazing work, be sure to ventilate the room sufficiently. Make sure that there are no hazardous or flammable materials nearby.
When performing the work in a closed room, small room, or similar location, make sure that there are no refrigerant leaks before performing the work.
If refrigerant leaks and accumulates, it may ignite or poisonous gases may be released.
- (13) Do not install the unit in places where refrigerant may build-up or places with poor ventilation such as a semi-basement or a sunken place in outdoor: Refrigerant is heavier than air, and inclined to fall away from the leak source.
- (14) Do not use means to accelerate the defrosting process or to clean, other than those recommended by the manufacturer.
- (15) The appliance shall be stored in a room without continuously operating ignition sources (for example: open flames, an operating gas appliance or an operating electric heater).
- (16) Do not pierce or burn.
- (17) Be aware that refrigerants may not contain an odor.
- (18) Pipe-work shall be protected from physical damage.
- (19) The installation of pipe-work shall be kept to a minimum.
- (20) Compliance with national gas regulations shall be observed.
- (21) Keep any required ventilation openings clear of obstruction.
- (22) Servicing shall be performed only as recommended by the manufacturer.
- (23) The appliance shall be stored in a well-ventilated area where the room size corresponds to the room area as specified for operation.
- (24) Maintenance, service and repair operations shall be performed by authorized technician with required qualification.

[2] Cautions for service

- (1) Perform service after recovering the refrigerant left in unit completely.
- (2) Do not release refrigerant in the air.
- (3) After completing service, charge the cycle with specified amount of refrigerant.
- (4) When performing service, install a filter drier simultaneously.
Be sure to use a filter drier for new refrigerant.

[3] Additional refrigerant charge

When charging directly from cylinder

- (1) Check that cylinder for R454B available on the market is a syphon type.
- (2) Charging should be performed with the cylinder of syphon stood vertically. (Refrigerant is charged from liquid phase.)

[4] Cautions for unit using R454B refrigerant

Basic work procedures are the same as those for conventional units using refrigerant R410A. However, pay careful attention to the following points:

- (1) Information on servicing
 - (1-1) Checks on the area

Prior to beginning work on systems containing FLAMMABLE REFRIGERANTS, safety checks are necessary to ensure that the risk of ignition is minimized.

For repair to the REFRIGERATING SYSTEM, 1-2 to 1-6 shall be completed prior to conducting work on the system.
 - (1-2) Work procedure

Work shall be undertaken under a controlled procedure so as to minimize the risk of a flammable gas or vapor being present while the work is being performed.
 - (1-3) General work area

All maintenance staff and others working in the local area shall be instructed on the nature of work being carried out. Work in confined spaces shall be avoided.
 - (1-4) Checking for presence of refrigerant

The area shall be checked with an appropriate refrigerant detector prior to and during work, to ensure the technician is aware of potentially toxic or flammable atmospheres. Ensure that the leak detection equipment being used is suitable for use with all applicable refrigerants, i.e. non-sparking, adequately sealed or intrinsically safe.
 - (1-5) Presence of fire extinguisher

If any hot work is to be conducted on the refrigerating equipment or any associated parts, appropriate fire extinguishing equipment shall be available to hand.

Have a dry powder or CO2 fire extinguisher adjacent to the charging area.
 - (1-6) No ignition sources

No person carrying out work in relation to a REFRIGERATING SYSTEM which involves exposing any pipe work shall use any sources of ignition in such a manner that it may lead to the risk of fire or explosion.

All possible ignition sources, including cigarette smoking, should be kept sufficiently far away from the site of installation, repairing, removing and disposal, during which refrigerant can possibly be released to the surrounding space.

Prior to work taking place, the area around the equipment is to be surveyed to make sure that there are no flammable hazards or ignition risks. "No Smoking" signs shall be displayed.
 - (1-7) Ventilated area

Ensure that the area is in the open or that it is adequately ventilated before breaking into the system or conducting any hot work. A degree of ventilation shall continue during the period that the work is carried out.

The ventilation should safely disperse any released refrigerant and preferably expel it externally into the atmosphere.
 - (1-8) Checks on the refrigeration equipment

Where electrical components are being changed, they shall be fit for the purpose and to the correct specification.

At all times the manufacturer's maintenance and service guidelines shall be followed.

If in doubt, consult the manufacturer's technical department for assistance.

The following checks shall be applied to installations using FLAMMABLE REFRIGERANTS:

 - the actual REFRIGERANT CHARGE is in accordance with the room size within which the refrigerant containing parts are installed;
 - the ventilation machinery and outlets are operating adequately and are not obstructed;
 - marking to the equipment continues to be visible and legible. Markings and signs that are illegible shall be corrected;
 - refrigerating pipe or components are installed in a position where they are unlikely to be exposed to any substance which may corrode refrigerant containing components, unless the components are constructed of materials which are inherently resistant to being corroded or are suitably protected against being so corroded.
 - (1-9) Checks on electrical devices

Repair and maintenance to electrical components shall include initial safety checks and component inspection procedures.

If a fault exists that could compromise safety, then no electrical supply shall be connected to the circuit until it is satisfactorily dealt with. If the fault cannot be corrected immediately but it is necessary to continue operation, an adequate temporary solution shall be used. This shall be reported to the owner of the equipment so all parties are advised.

Initial safety checks shall include:

 - that capacitors are discharged: this shall be done in a safe manner to avoid possibility of sparking;
 - that no live electrical components and wiring are exposed while charging, recovering or purging the system;
 - that there is continuity of earth bonding.
 -
- (2) Repairs to sealed components

Sealed electrical components shall be replaced
- (3) Repair to intrinsically safe components

Intrinsically safe components must be replaced.
- (4) Cabling

Check that cabling will not be subject to wear, corrosion, excessive pressure, vibration, sharp edges or any other adverse environmental effects.

The check shall also take into account the effects of aging or continual vibration from sources such as compressors or fans.

(5) Detection of flammable refrigerants

Under no circumstances shall potential sources of ignition be used in the searching for or detection of refrigerant leaks.

A halide torch (or any other detector using a naked flame) shall not be used.

The following leak detection methods are deemed acceptable for all refrigerant systems.

Electronic leak detectors may be used to detect refrigerant leaks but, in the case of FLAMMABLE REFRIGERANTS, the sensitivity may not be adequate, or may need re-calibration. (Detection equipment shall be calibrated in a refrigerant-free area.) Ensure that the detector is not a potential source of ignition and is suitable for the refrigerant used.

Leak detection equipment shall be set at a percentage of the LFL of the refrigerant and shall be calibrated to the refrigerant employed, and the appropriate percentage of gas (25 % maximum) is confirmed.

Leak detection fluids are also suitable for use with most refrigerants but the use of detergents containing chlorine shall be avoided as the chlorine may react with the refrigerant and corrode the copper pipe-work.

If a leak is suspected, all naked flames shall be removed/extinguished.

If a leakage of refrigerant is found which requires brazing, all of the refrigerant shall be recovered from the system, or isolated (by means of shut off valves) in a part of the system remote from the leak. Removal of refrigerant shall be according to 2-4.6.

(6) Removal and evacuation

When breaking into the refrigerant circuit to make repairs - or for any other purpose -conventional procedures shall be used. However, for flammable refrigerants it is important that best practice be followed, since flammability is a consideration. The following procedure shall be adhered to:

- safely remove refrigerant following local and national regulations;
- evacuate;
- purge the circuit with inert gas;
- evacuate;
- continuously flush or purge with inert gas when using flame to open circuit;
- open the circuit.

The refrigerant charge shall be recovered into the correct recovery cylinders if venting is not allowed by local and national codes. For appliances containing flammable refrigerants, the system shall be purged with oxygen-free nitrogen to render the appliance safe for flammable refrigerants. This process might need to be repeated several times.

Compressed air or oxygen shall not be used for purging refrigerant systems.

For appliances containing flammable refrigerants, refrigerants purging shall be achieved by breaking the vacuum in the system with oxygen-free nitrogen and continuing to fill until the working pressure is achieved, then venting to atmosphere, and finally pulling down to a vacuum.

This process shall be repeated until no refrigerant is within the system. When the final oxygen-free nitrogen charge is used, the system shall be vented down to atmospheric pressure to enable work to take place.

The outlet for the vacuum pump shall not be close to any potential ignition sources, and ventilation shall be available.

(7) Charging procedures

In addition to conventional charging procedures, the following requirements shall be followed:

- Ensure that contamination of different refrigerants does not occur when using charging equipment. Hoses or lines shall be as short as possible to minimize the amount of REFRIGERANT contained in them.
- Cylinders shall be kept in an appropriate position according to the instructions.
- Ensure that the REFRIGERATING SYSTEM is earthed prior to charging the system with refrigerant.
- Label the system when charging is complete (if not already).
- Extreme care shall be taken not to overfill the REFRIGERATING SYSTEM.

Prior to recharging the system, it shall be pressure-tested with the appropriate purging gas. The system shall be leak-tested on completion of charging but prior to commissioning.

A follow up leak test shall be carried out prior to leaving the site.

(8) Decommissioning

Before carrying out this procedure, it is essential that the technician is completely familiar with the equipment and all its detail. It is recommended good practice that all refrigerants are recovered safely.

Prior to the task being carried out, an oil and refrigerant sample shall be taken in case analysis is required prior to re-use of recovered refrigerant. It is essential that electrical power is available before the task is commenced.

a) Become familiar with the equipment and its operation.

b) Isolate system electrically.

c) Before attempting the procedure, ensure that:

- mechanical handling equipment is available, if required, for handling refrigerant cylinders;
- all personal protective equipment is available and being used correctly;
- the recovery process is supervised at all times by a competent person;
- recovery equipment and cylinders conform to the appropriate standards.

d) Pump down refrigerant system, if possible.

e) If a vacuum is not possible, make a manifold so that refrigerant can be removed from various parts of the system.

f) Make sure that cylinder is situated on the scales before recovery takes place.

g) Start the recovery machine and operate in accordance with instructions.

h) Do not overfill cylinders (no more than 80 % volume liquid charge).

i) Do not exceed the maximum working pressure of the cylinder, even temporarily.

- j) When the cylinders have been filled correctly and the process completed, make sure that the cylinders and the equipment are removed from site promptly and all isolation valves on the equipment are closed off.
- k) Recovered refrigerant shall not be charged into another REFRIGERATING SYSTEM unless it has been cleaned and checked.

(9) Labelling

Equipment shall be labelled stating that it has been de-commissioned and emptied of refrigerant. The label shall be dated and signed. For appliances containing FLAMMABLE REFRIGERANTS, ensure that there are labels on the equipment stating the equipment contains FLAMMABLE REFRIGERANT.

(10) Recovery

When removing refrigerant from a system, either for servicing or decommissioning, it is recommended good practice that all refrigerants are removed safely.

When transferring refrigerant into cylinders, ensure that only appropriate refrigerant recovery cylinders are employed. Ensure that the correct number of cylinders for holding the total system charge is available.

All cylinders to be used are designated for the recovered refrigerant and labelled for that refrigerant (i.e. special cylinders for the recovery of refrigerant). Cylinders shall be complete with pressure-relief valve and associated shut-off valves in good working order.

Empty recovery cylinders are evacuated and, if possible, cooled before recovery occurs.

The recovery equipment shall be in good working order with a set of instructions concerning the equipment that is at hand and shall be suitable for the recovery of the flammable refrigerant.

If in doubt, the manufacturer should be consulted. In addition, a set of calibrated weighing scales shall be available and in good working order. Hoses shall be complete with leak-free disconnect couplings and in good condition.

The recovered refrigerant shall be processed according to local legislation in the correct recovery cylinder, and the relevant waste transfer note arranged. Do not mix refrigerants in recovery units and especially not in cylinders.

If compressors or compressor oils are to be removed, ensure that they have been evacuated to an acceptable level to make certain that flammable refrigerant does not remain within the lubricant.

The compressor body shall not be heated by an open flame or other ignition sources to accelerate this process. When oil is drained from a system, it shall be carried out safely.

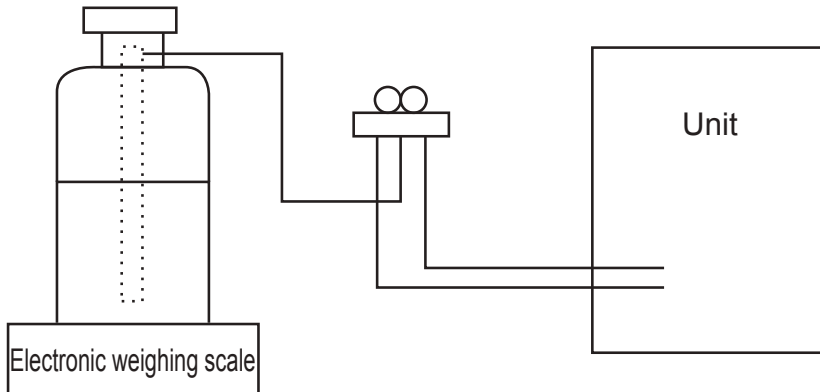

[3] Service tools

Use the below service tools as exclusive tools for R410A refrigerant.

No.	Tool name	Specifications
①	Gauge manifold	<ul style="list-style-type: none"> · Only for R454B · Use the existing fitting specifications. (UNF1/2) · Use high-tension side pressure of 768.7 PSIG [5.3 MPaG] or over.
②	Charge hose	<ul style="list-style-type: none"> · Only for R454B · Use pressure performance of 738.2 PSIG [5.09 MPaG] or over.
③	Electronic weighing scale	—
④	Gas leak detector	· Use the detector for R454B.
⑤	Adaptor for reverse flow check	· Attach on vacuum pump.
⑥	Refrigerant charge base	—
⑦	Refrigerant cylinder	<ul style="list-style-type: none"> · Only for R454B · Cylinder with syphon
⑧	Refrigerant recovery equipment	—
⑨	Micron gauge	—

2

PARTS NAMES AND FUNCTIONS

2-1. Indoor Unit

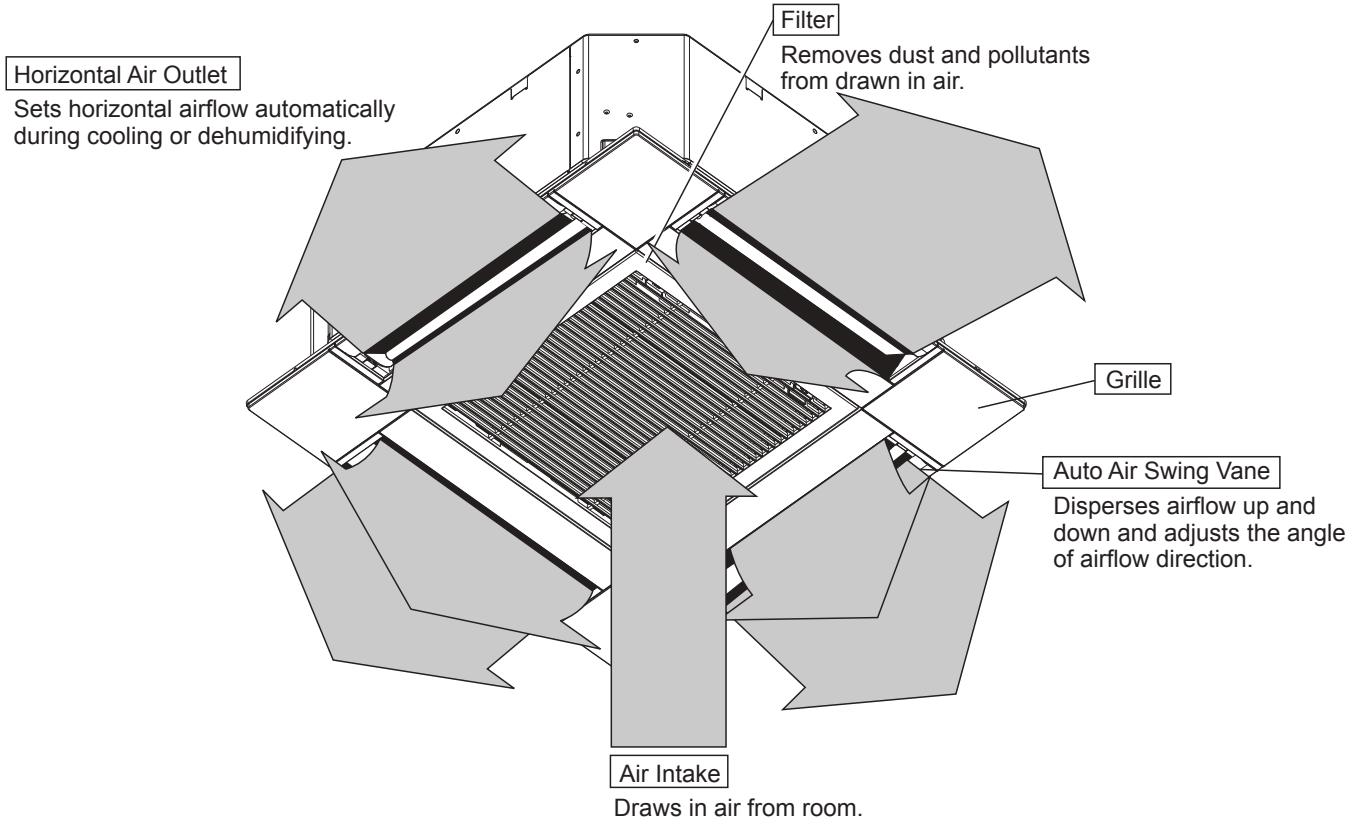

2-2. Wired Remote Controller <PAR-42MAAUB> <PAC-YT53CRAU>

Wired remote controller function

The functions which can be used are restricted according to each model.

○ : Supported × : Unsupported

	Function		PAR-42MAAUB		PAC-YT53CRAU
			Slim	City multi	
Body	Product size H × W × D	mm (in.)	120 × 120 × 14.5 (4-3/4 × 4-3/4 × 9/16)		120 × 70 × 14.5 (4-3/4 × 2-3/4 × 9/16)
	LCD		Full Dot LCD		Partial Dot LCD
	Backlight		○		○
Energy-saving	Energy-saving operation schedule		○	×	×
	Automatic return to the preset temperature		○		×
Restriction	Setting the temperature range restriction		○		○
Function	Operation lock function		○		○
	Weekly timer		○		×
	ON/OFF timer		○		×
	High Power		○	×	×
	Manual vane angle		○		×

3-1. SPECIFICATIONS

Service Ref.		PLFY-L05NFMU-A	PLFY-L08NFMU-A	PLFY-L12NFMU-A	PLFY-L15NFMU-A	PLFY-L18NFMU-A	
power source		1-phase, 208/230 V, 60 Hz					
cooling capacity	kW	1.4	2.3	3.5	4.4	5.3	
*1	*1 BTU/h	5,000	8,000	12,000	15,000	18,000	
	Power input kW	0.02	0.02	0.02	0.03	0.04	
	Current input A	0.19	0.22	0.23	0.28	0.40	
Heating capacity	kW	1.6	2.6	4.0	5.0	5.9	
*3	*3 BTU/h	5,600	9,000	13,500	17,000	20,000	
	Power input kW	0.02	0.02	0.02	0.03	0.04	
	Current input A	0.14	0.17	0.18	0.23	0.35	
External finish		Galvanized steel sheet					
External dimension	mm	208×570×570					
H × W × D	in	8-3/16"×22-7/16"×22-7/16"					
Net weight	kg (lb)	13.1 (28.9)		14.2(31.3)			
Decoration panel	model	SLP-18FAU					
	External finish	Munsell 1.0Y 9.2/0.2					
	Dimension	10 × 625 × 625					
	H × W × D	13/32"×24-19/32"×24-19/32"					
	Net weight	2.4(5.3)					
Heat exchanger		Cross fin (Aluminum fin and copper tube)					
FAN	Type	Turbo fan × 1					
	External static pressure	0 Pa (0 mmH ₂ O)					
	Motor type	DC motor					
	Motor output kW	0.05					
	Driving mechanism	Direct driven					
	Airflow rate	m ³ /min	6.5-7.5-8.0	6.5-8.0-9.0	7.0-8.0-9.5	7.5-9.0-11.0	9.0-11.0-13.0
		L/s	108-125-133	108-133-150	117-133-158	125-150-183	150-183-217
		cfm	230-265-280	230-280-315	245-280-335	265-315-390	315-390-460
Noise level (Low-Mid-High) (measured in anechoic room)	dB <A>	26-28-30	26-30-33	26-30-34	28-33-39	33-39-43	
Insulation material		PS					
Air filter		PP honeycomb fabric (long life type)					
Protection device		Fuse					
Refrigerant control device		LEV					
Connectable outdoor unit		R454B CITY MULTI					
Diameter of refrigerant pipe	Liquid	ø6.35 (ø1/4") Flare					
	Gas	ø12.7 (ø1/2") Flare					
Field drain pipe size	mm (in)	O.D. 32 mm (1-1/4") (PVC pipe VP-25 connectable)					
Standard attachment		Installation manual, Instruction book					
Remark	Optional parts	Decoration panel : SLP-18FAU, SLP-18FAEU *PLFY-L NFMU should be used together with decoration panel.					
	Installation	Details on foundation work, duct work, insulation work, electrical wiring, power source switch, and other items shall be referred to the Installation Manual.					

*1 Nominal cooling condition indoor : 27°CDB/19°CWB (81°FDB/66°FWB) Outdoor : 35°CDB (95°FDB) Pipe length : 7.5m (24-9/16 ft) Level difference : 0m (0 ft)	*2 Nominal heating condition 20°CDB (68°FDB) 7°CDB/6°CWB (45°FDB/43°FWB) 7.5 m (24-9/16 ft) 0 m (0 ft)	Unit converter kcal= kW × 860 BTU/h =3,412 cfm = K/min × 35.31 lb = kg/0.4536
Notes: 1. Nominal conditions *1 and *2 are subject to JIS B8615-1. 2. Due to continuing improvement, above specification may be subject to change without notice.		

3-2. ELECTRICAL PARTS SPECIFICATIONS

Parts name	Service ref.	Symbol	PLFY-L05NFMU-A	PLFY-L08NFMU-A	PLFY-L12NFMU-A	PLFY-L15NFMU-A	PLFY-L18NFMU-A
Thermistor (Room temperature detection)	TH21		Resistance 30°F/15.8 Ω, 50°F/9.6 Ω, 70°F/6.0 Ω, 80°F/4.8 Ω, 90°F/3.9 Ω, 100°F/3.2 Ω				
Thermistor (Pipe temperature detection/Liquid)	TH22		Resistance 30°F/15.8 Ω, 50°F/9.6 Ω, 70°F/6.0 Ω, 80°F/4.8 Ω, 90°F/3.9 Ω, 100°F/3.2 Ω				
Thermistor (Pipe temperature detection/Gas)	TH23		Resistance 30°F/15.8 Ω, 50°F/9.6 Ω, 70°F/6.0 Ω, 80°F/4.8 Ω, 90°F/3.9 Ω, 100°F/3.2 Ω				
Fuse (Indoor controller board)	FUSE		250V 6.3A				
Fan motor	MF		OUTPUT 50 W				
Vane motor	MV		MSBPC20M32 (green label)/MSBPC20M33 (blue label) DC12V 300 Ω/phase				
Drain pump	DP		PMD-12D13ME INPUT 3.9W (DC 13V) 24l/Hr				
Drain float switch	FS		Open/short detection				
Linear expansion valve [coil]	LEV		DC12V Stepping motor drive, Port dimension ø5.2 (0–2000pulse) PAM-B40YGME				
Power supply terminal block	TB2		(L1, L2) Rated to 330V 30A*				
Transmission terminal block	TB5		(M1, M2, S) Rated to 250V 20A*				
MA remote controller terminal block	TB15		(1, 2) Rated to 250V 10A*				

* Refer to WIRING DIAGRAM for the supplied voltage.

3-3 SOUND PRESSURE LEVEL

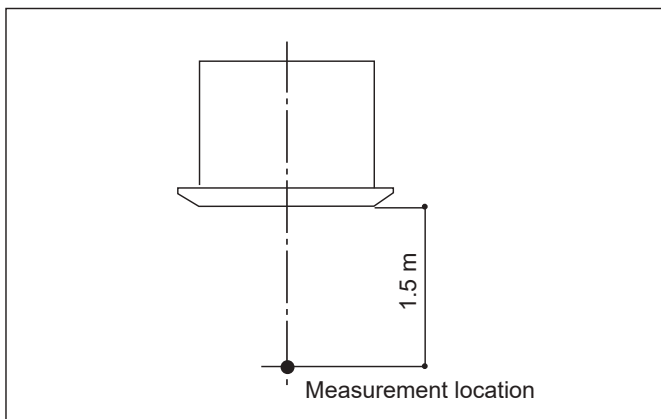

Service Ref.	Sound pressure level dB (A)
	Low-Mid-High
PLFY-L05NFMU-A	26-28-30
PLFY-L08NFMU-A	26-30-33
PLFY-L12NFMU-A	26-30-34
PLFY-L15NFMU-A	28-33-39
PLFY-L18NFMU-A	33-39-43

Note: Measured in anechoic room.

3-4. NOISE CRITERION CURVES

PLFY-L05NFMU-A

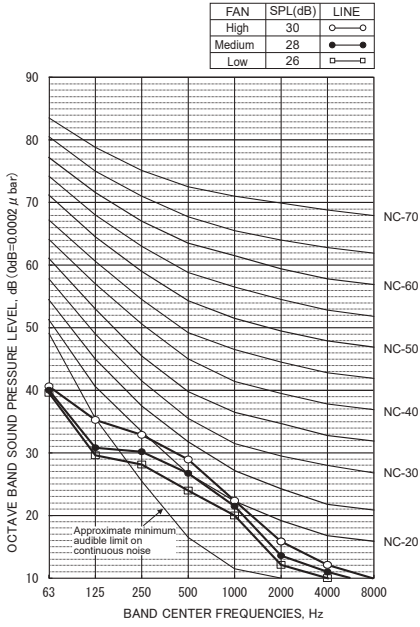

PLFY-L08NFMU-A

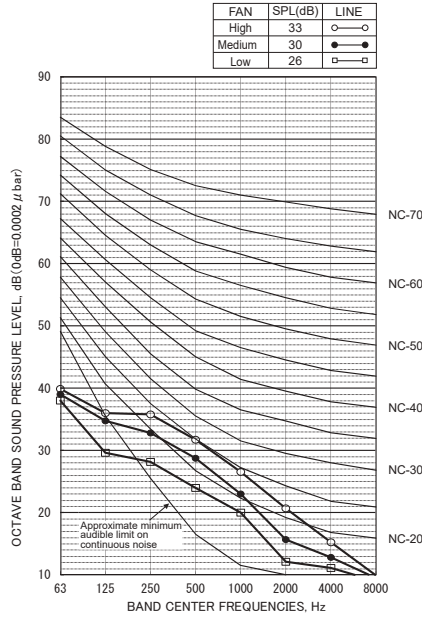

PLFY-L12NFMU-A

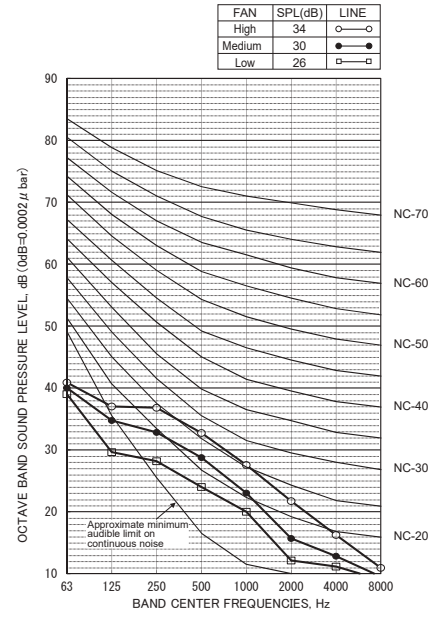

PLFY-L15NFMU-A

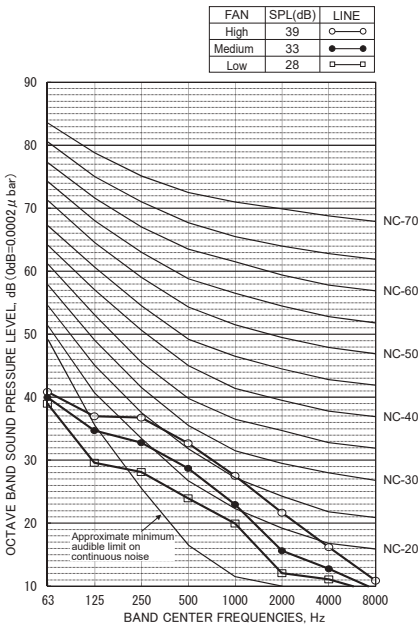

PLFY-L18NFMU-A

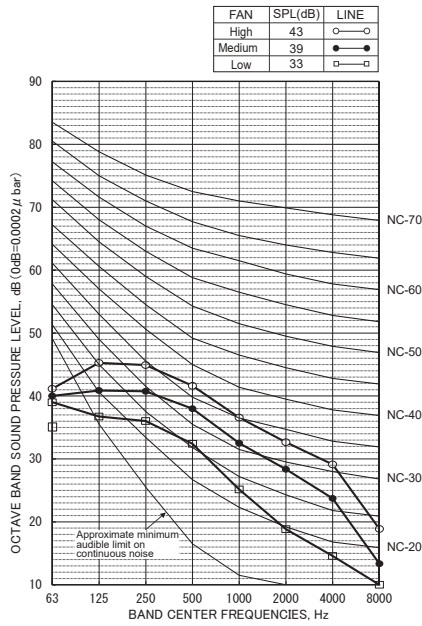

4

4-WAY AIR FLOW SYSTEM

4-1. FRESH AIR INTAKE (Location for installation)

At the time of installation, use the duct holes (cut out) located at the positions shown in following diagram, as and when required.

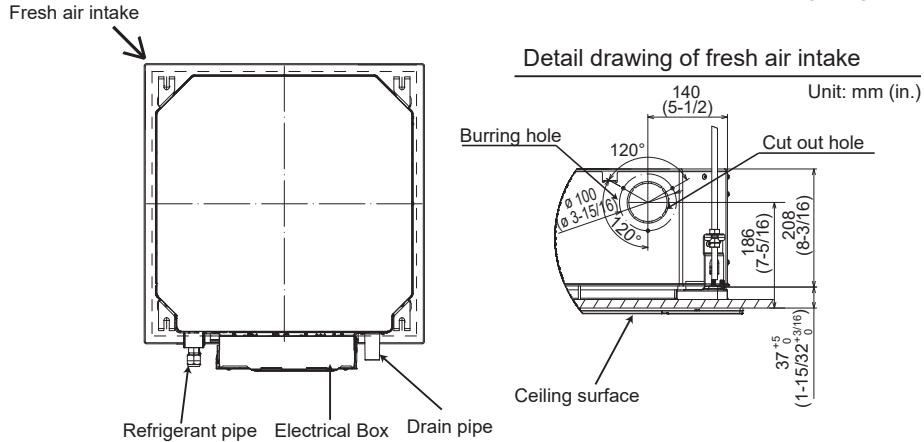

4-2. FRESH AIR INTAKE AMOUNT & STATIC PRESSURE CHARACTERISTICS

Taking air into the unit

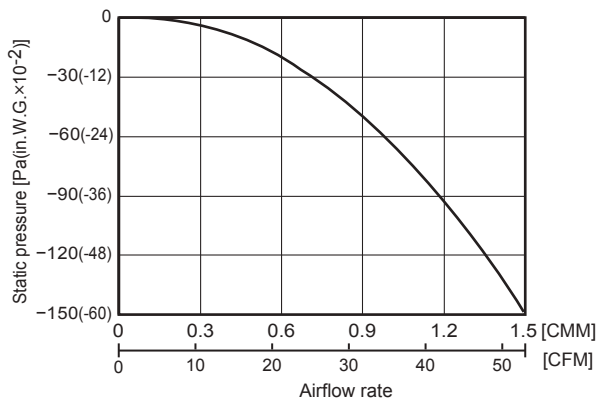

How to read curves

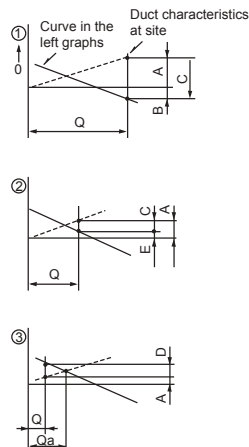

- Q...Designed amount of fresh air intake <CMM (CFM)>
- A...Static pressure loss of fresh air intake duct system with air flow amount Q <Pa (in.W.G.×10⁻²)>
- B...Forced static pressure at air conditioner inlet with air flow amount Q <Pa (in.W.G.×10⁻²)>
- C...Static pressure of booster fan with air flow amount Q <Pa (in.W.G.×10⁻²)>
- D...Static pressure loss increase amount of fresh air intake duct system for air flow amount Q <Pa (in.W.G.×10⁻²)>
- E...Static pressure of indoor unit with air flow amount Q <Pa (in.W.G.×10⁻²)>
- Qa...Estimated amount of fresh air intake without D <CMM (CFM)>

NOTE: Fresh air intake amount should be 10% or less of whole air amount to prevent dew dripping.

4-3. OPERATION IN CONJUNCTION WITH DUCT FAN (Booster fan)

• Whenever the indoor unit operates, the duct fan also operates.

- (1) Connect the optional multiple remote controller adapter (PAC-SA88HA-EP) to the connector CN51 on the indoor controller board.
- (2) Drive the relay after connecting the 12 VDC relay between the Yellow and Orange connector wires.

MB: Electromagnetic switch power relay for duct fan.
 X: Auxiliary relay
 (For 12 VDC, coil rating: 1.0 W or below)

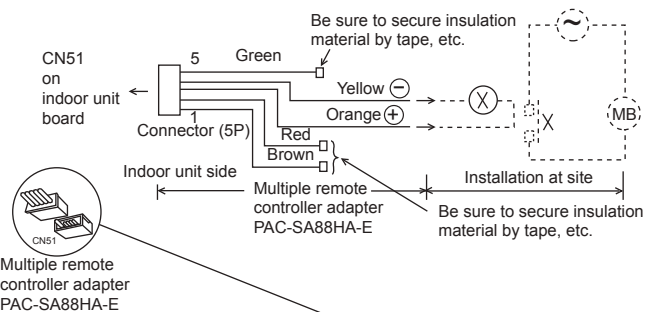

4-4. FIXING HORIZONTAL VANE

Horizontal vane of each air outlet can be fixed according to the environment where it is installed.

Setting procedures

- 1) Turn off a main power supply (Turn off a breaker).
- 2) Disconnect the vane motor connector of the direction of the arrow with pressing the unlocking button as shown in figure below.
Insulate the disconnected connector with the plastic tape.

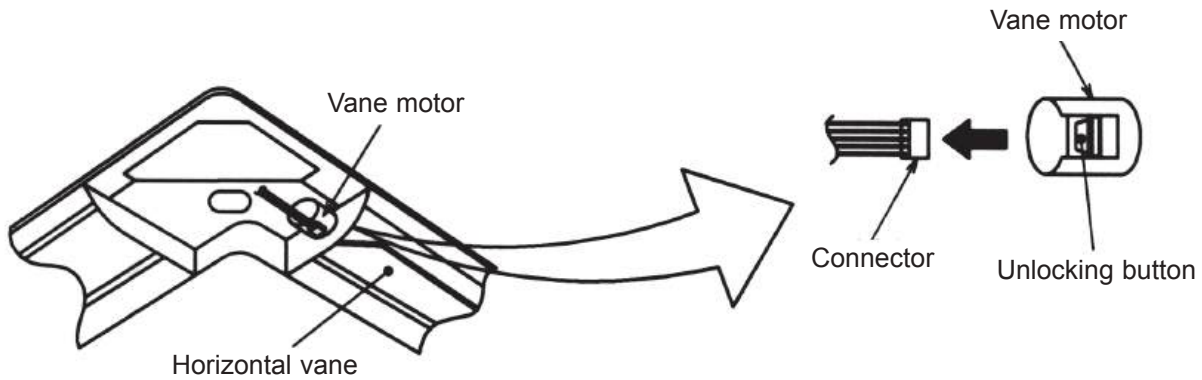

- 3) Set the vertical vane of the air outlet by hand slowly within the range in the table below.

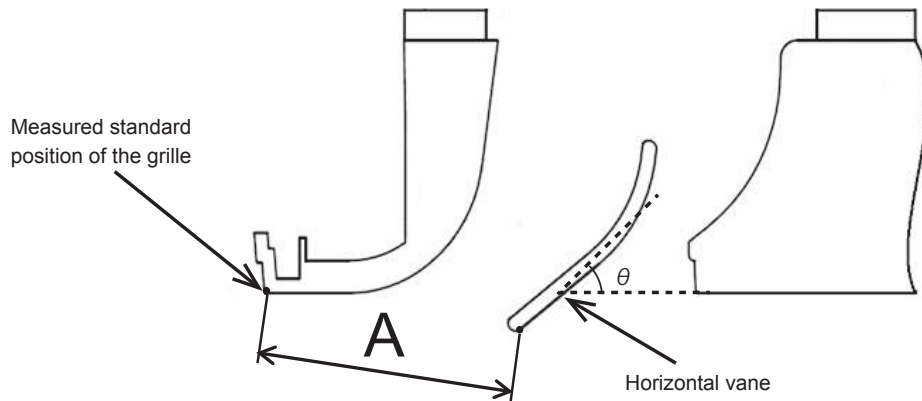

<Set range>

Standard of horizontal position	Angle $\theta = 21^\circ$ (Horizontal)	Angle $\theta = 24^\circ$	Angle $\theta = 39^\circ$	Angle $\theta = 42^\circ$	Angle $\theta = 45^\circ$ (Downward)
Dimension A inch (mm)	1-17/32 (39)	1-39/64 (41)	1-27/32(47)	1-57/64(48)	1-57/64(49)

Note: Dimension between 1-17/32 (39) and 1-57/64(49) can be arbitrarily set.

Caution



Do not set the dimension out of the range.

Erroneous setting could cause dew drips or malfunction of unit.

Unit: mm (in.)

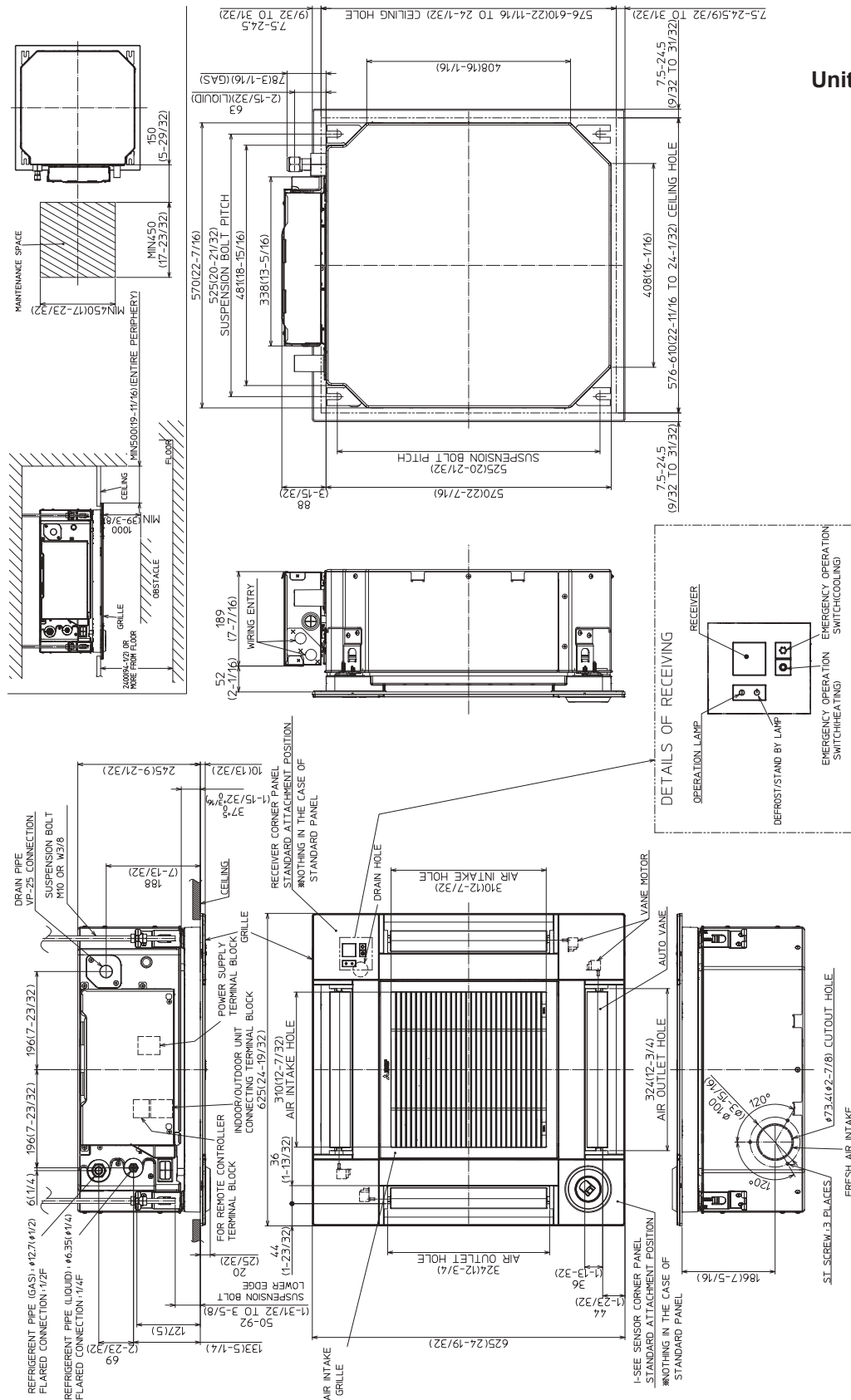

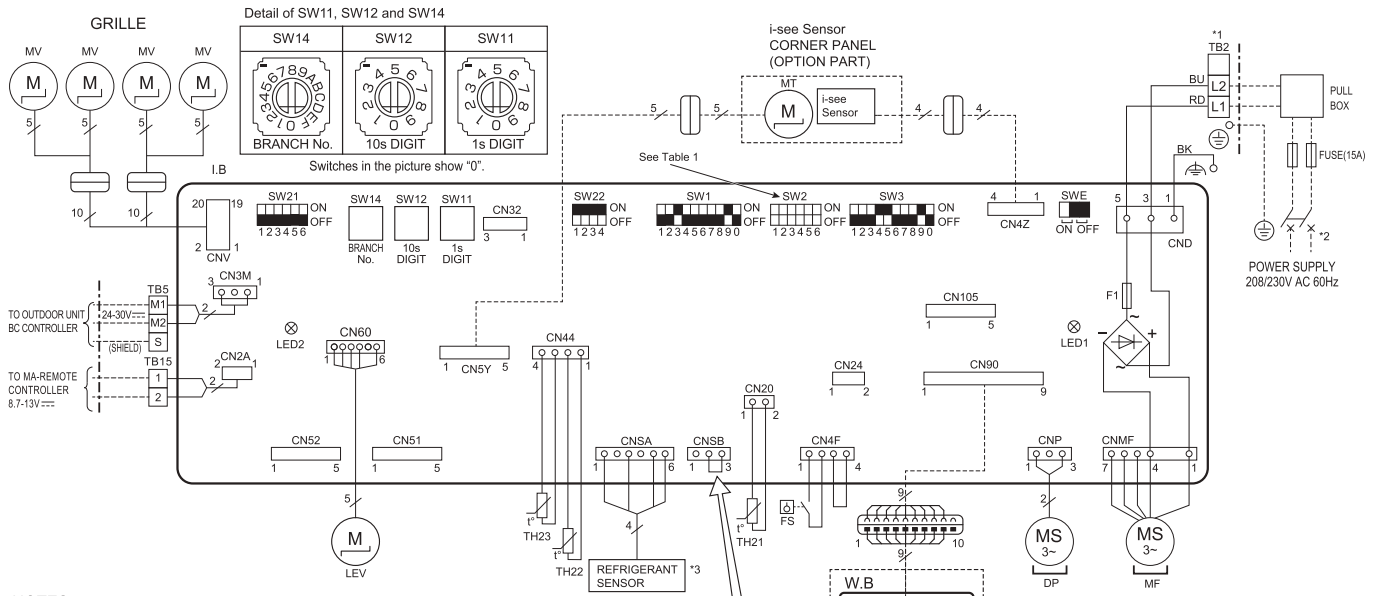

NOTES:

1. At servicing for outdoor unit, always follow the wiring diagram of outdoor unit.
2. In case of using MA-Remote controller, please connect to TB15. (Remote controller wire is non-polar.)
3. Symbol [S] of TB5 is the shield wire connection.
4. Symbols used in wiring diagram are, : terminal block, : connector.
5. The setting of the SW2 dip switches differs in the capacity. For the detail, see Table 1.
6. Make sure to turn off the indoor and the outdoor units before replacing indoor controller board.
7. The black square (■) in the wiring diagram indicates a switch position.

- *1 Use copper supply wires.
Utiliser des fils d'alimentation en cuivre.
- *2 A disconnect should be required by local code.
Se procurer un sectionneur conforme aux réglementations locales.
- *3 This refrigerant sensor shall only be replaced with manufacturer approved sensor.
Ce capteur de réfrigérant ne doit être remplacé que par un capteur approuvé par le fabricant.

When you install indoor units in a large space, the refrigerant sensor can be disabled by disconnecting the jumper connector. Refer to the installation manual for the definition of a large space.

<Table 1>

MODEL	SW2	MODEL	SW2
05	ON OFF 123456	15	ON OFF 123456
08	ON OFF 123456	18	ON OFF 123456
12	ON OFF 123456		

[LEGEND]

SYMBOL	NAME
I.B	INDOOR CONTROLLER BOARD
CN24	EXTERNAL HEATER
CN32	REMOTE SWITCH
CN51	CENTRALLY CONTROL
CN52	REMOTE INDICATION
CN105	IT TERMINAL
F1	FUSE (T6.3AL250V)
LED1	POWER SUPPLY (I.B)
LED2	POWER SUPPLY (MA-REMOTE CONTROLLER)
SW1	MODE SELECTION
SW2	CAPACITY CODE
SW3	MODE SELECTION
SW11	ADDRESS SETTING ONES DIGIT
SW12	ADDRESS SETTING TENS DIGIT
SW14	BRANCH No.
SW21	CEILING HEIGHT SELECTOR
SW22	PAIR NO. SETTING
SWE	DRAIN PUMP(TEST MODE)
DP	DRAIN PUMP
LEV	LINEAR EXPANSION VALVE
MF	FAN MOTOR
MV	VANE MOTOR
FS	FLOAT SWITCH
TB2	TERMINAL POWER SUPPLY
TB5	BLOCK TRANSMISSION
TB15	MA-REMOTE CONTROLLER
TH21	ROOM TEMP. THERMISTOR (0°C/15kΩ, 25°C/5.4kΩ, 32°F/15kΩ, 77°F/5.4kΩ)
TH22	PIPE TEMP. THERMISTOR/LIQUID (0°C/15kΩ, 25°C/5.4kΩ, 32°F/15kΩ, 77°F/5.4kΩ)
TH23	PIPE TEMP. THERMISTOR/GAS (0°C/15kΩ, 25°C/5.4kΩ, 32°F/15kΩ, 77°F/5.4kΩ)
OPTIONAL PARTS	
W.B	WIRELESS REMOTE CONTROLLER BOARD
BZ	BUZZER
LED1	OPERATION (GREEN)
LED2	STAND BY (ORANGE)
RU	RECEIVING UNIT
SW1	EMERGENCY OPERATION(HEAT)
SW2	EMERGENCY OPERATION(COOL)
MT	i-see Sensor MOTOR

7

REFRIGERANT SYSTEM DIAGRAM

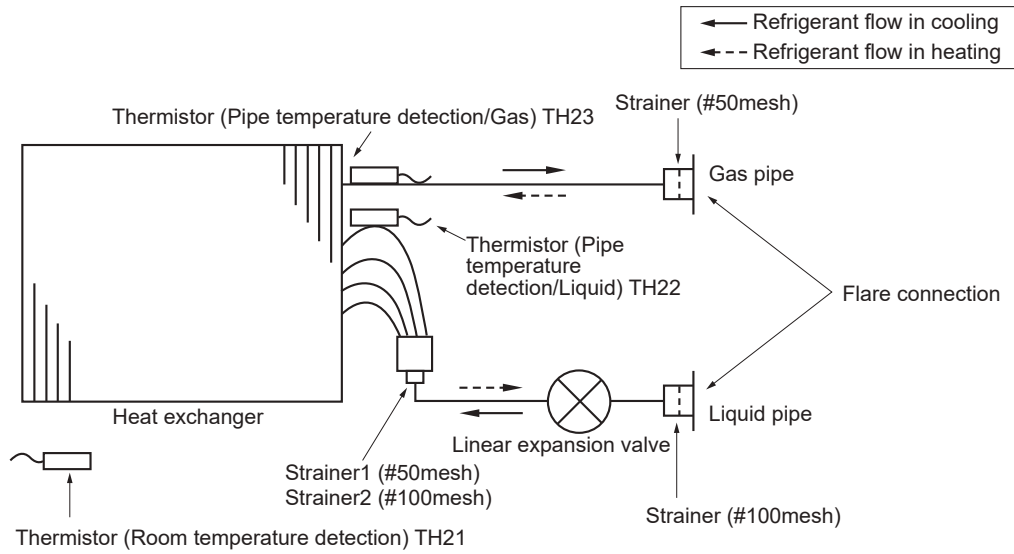

Refrigerant pipe diameter	Unit: mm (in.)
Gas pipe	ø12.7(1/2)
Liquid pipe	ø6.35(1/4)

8

MICROPROCESSOR CONTROL

INDOOR UNIT CONTROL 8-1. COOL OPERATION

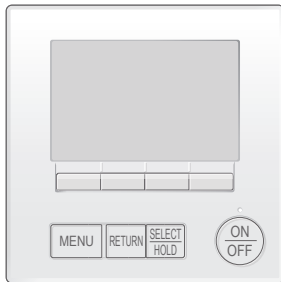

<How to operate>

- 1 Press ON/OFF button.
- 2 Press [F1] button to display COOL.
- 3 Press [F2] [F3] button to set the set temperature.

NOTE: The settable temperature range varies with the model of outdoor units and remote controller.

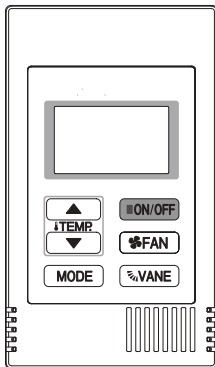



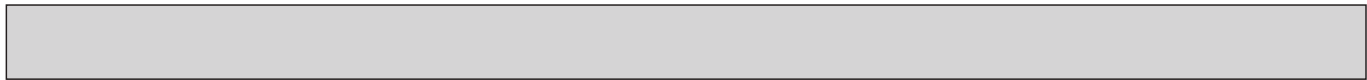

<How to operate>

- 1 Press POWER ON/OFF button.
- 2 Press the operation MODE button to display COOL.
- 3 Press the TEMP. button to set the set temperature.

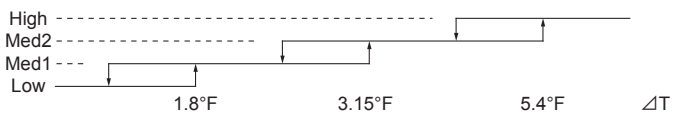
NOTE: The set temperature changes 1°F when the ∇ or Δ button is pressed one time. Cooling 67 to 87°F

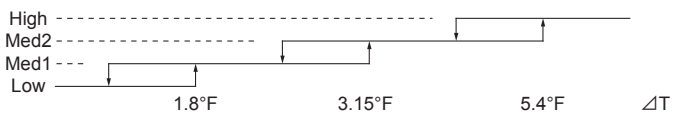

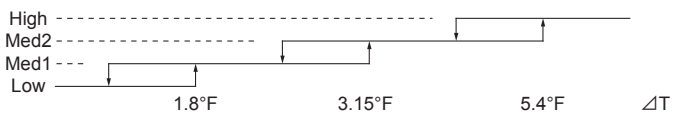
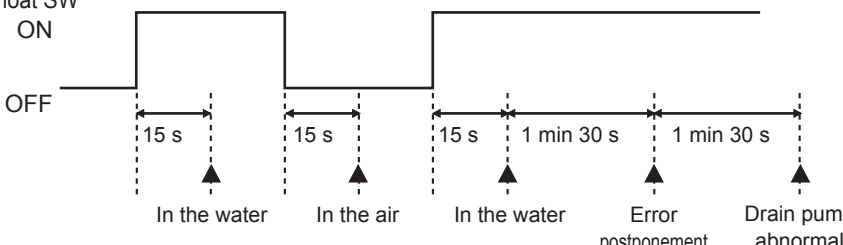
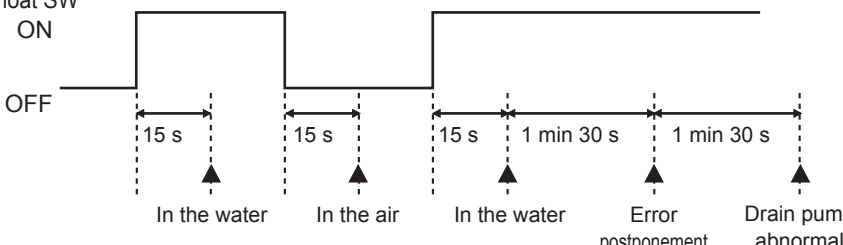
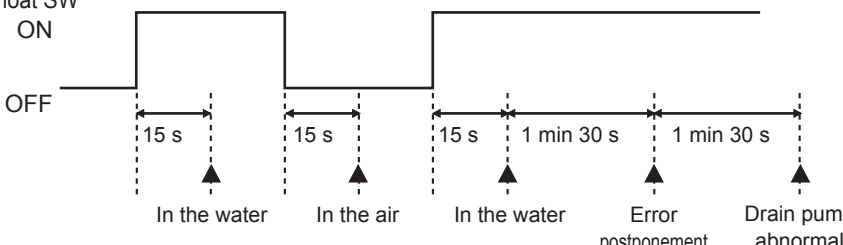
Control Mode	Control Details	Remarks												
1. Temperature adjustment function	<p>1-1. Determining temperature adjustment function (Function to prevent restarting for 3 minutes)</p> <ul style="list-style-type: none"> Room temperature \geq Set temperature + 1°F ...Thermo-ON Room temperature \leq Set temperature - 1°F ...Thermo-OFF <p>1-2. Anti-freeze control</p> <ul style="list-style-type: none"> Condition to detect When the pipe temperature detection thermistor/liquid (TH22) detects 32°F or less in 16 minutes from thermo-ON, the anti-freeze control initiates, and the unit enters to the thermo-OFF. Condition to release The timer which prevents reactivating is set for 3 minutes, and anti-freeze control is cancelled when any one of the following conditions has been satisfied: <ol style="list-style-type: none"> Pipe temperature detection thermistor/liquid (TH22) reaches 50°F or above. The condition of thermo-OFF has been completed by the thermostat. The operation has changed to a mode other than COOLING. 	<ul style="list-style-type: none"> The ON/OFF commands by the indoor unit thermostatic control are not an ON/OFF commands to the compressor but an open/close commands to the linear expansion valve. (The compressor stops only when the thermostatic control for all the indoor units connected to the same outdoor unit turns OFF.) 												
2. Fan	<p>By the remote controller setting (switch of 4 speeds+Auto)</p> <table border="1" data-bbox="300 755 1021 904"> <thead> <tr> <th>Type</th> <th>Fan speed notch</th> </tr> </thead> <tbody> <tr> <td>3 speeds + Auto type</td> <td>  </td> </tr> </tbody> </table> <p>When [Auto] is set, fan speed is changed depending on the value of: $\Delta T = \text{Room temperature} - \text{Set temperature}$</p> <table border="1" data-bbox="306 968 1013 1106"> <thead> <tr> <th>High</th> <th>Med2</th> <th>Med1</th> <th>Low</th> </tr> </thead> <tbody> <tr> <td colspan="4" style="text-align: center;">  </td> </tr> </tbody> </table>	Type	Fan speed notch	3 speeds + Auto type		High	Med2	Med1	Low					
Type	Fan speed notch													
3 speeds + Auto type														
High	Med2	Med1	Low											
														
3. Drain pump	<p>3-1. Drain pump control</p> <ul style="list-style-type: none"> The drain pump will always run when the unit is in COOL or DRYING mode. (Regardless of the thermo ON/OFF) Whenever the operation is changed over to the other modes (including Stop), the drain pump will stop pumping after approximately 3 minutes. <p>Float switch control</p> <ul style="list-style-type: none"> Float switch control judges whether the sensor is in the air or in the water by turning the float switch ON/OFF. In the water: Detected that the float switch is ON for 15 seconds. In the air: Detected that the float switch is OFF for 15 seconds <p>Float SW</p> <table border="1" data-bbox="303 1457 1181 1723"> <thead> <tr> <th>Float SW</th> <th>ON</th> <th>OFF</th> </tr> </thead> <tbody> <tr> <td colspan="3" style="text-align: center;">  </td> </tr> </tbody> </table>	Float SW	ON	OFF										
Float SW	ON	OFF												
														
4. Vane (up/down vane change)	<p>(1) The initial vane setting for COOL mode will be the horizontal position.</p> <p>(2) Vane position: Horizontal →Downward A →Downward B →Downward C→Downward D→Swing→Auto</p> <p>(3) Restriction of the downward vane setting If the vane position is set to Downward A/B/C/D in [Med1], [Med2], or [Low], the vane will return to the horizontal position after 1 hour has passed.</p>	<ul style="list-style-type: none"> "1h" appears on the wired remote controller. 												

8-2. DRYING OPERATION

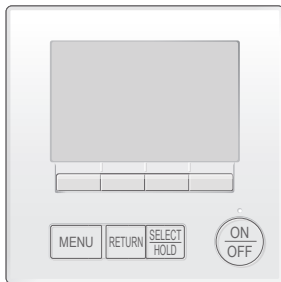

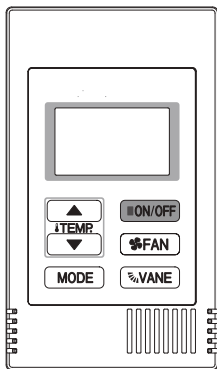

<How to operate>

- 1 Press ON/OFF button.
- 2 Press [F1] button to display DRYING.
- 3 Press [F2] [F3] button to set the set temperature.



<How to operate>

- 1 Press POWER ON/OFF button.
- 2 Press the operation MODE button to display DRYING.
- 3 Press the TEMP. button to set the set temperature.

NOTE: The set temperature changes 1°F when the  or  button is pressed one time. Dry 67 to 87°F

Control Mode	Control Details	Remarks																													
1. Temperature adjustment function	1-1. Determining temperature adjustment function (Function to prevent restarting for 3 minutes) Setting the Dry thermo by the thermostat signal and the room temperature (TH21). Dry thermo-ON Room temperature \geq Set temperature + 1°F Dry thermo-OFF Room temperature \leq Set temperature - 1°F																														
	<table border="1"> <thead> <tr> <th rowspan="2">Room temperature</th> <th colspan="2">3 minutes passed since starting operation</th> <th rowspan="2">Dry thermo-ON time (min)</th> <th rowspan="2">Dry thermo-OFF time (min)</th> </tr> <tr> <th>Thermostat signal</th> <th>Room temperature (T1)</th> </tr> </thead> <tbody> <tr> <td rowspan="4">Over 64°F</td> <td rowspan="4">ON</td> <td>T1 \geq 83°F</td> <td>9</td> <td>3</td> </tr> <tr> <td>83°F > T1 \geq 79°F</td> <td>7</td> <td>3</td> </tr> <tr> <td>79°F > T1 \geq 75°F</td> <td>5</td> <td>3</td> </tr> <tr> <td>75°F > T1</td> <td>3</td> <td>3</td> </tr> <tr> <td>Below 64°F</td> <td>OFF</td> <td>Unconditional</td> <td>3</td> <td>10</td> </tr> <tr> <td colspan="5" style="text-align: center;">Dry thermo OFF</td> </tr> </tbody> </table>		Room temperature	3 minutes passed since starting operation		Dry thermo-ON time (min)	Dry thermo-OFF time (min)	Thermostat signal	Room temperature (T1)	Over 64°F	ON	T1 \geq 83°F	9	3	83°F > T1 \geq 79°F	7	3	79°F > T1 \geq 75°F	5	3	75°F > T1	3	3	Below 64°F	OFF	Unconditional	3	10	Dry thermo OFF		
Room temperature	3 minutes passed since starting operation			Dry thermo-ON time (min)	Dry thermo-OFF time (min)																										
	Thermostat signal	Room temperature (T1)																													
Over 64°F	ON	T1 \geq 83°F	9	3																											
		83°F > T1 \geq 79°F	7	3																											
		79°F > T1 \geq 75°F	5	3																											
		75°F > T1	3	3																											
Below 64°F	OFF	Unconditional	3	10																											
Dry thermo OFF																															
	1-2. Anti-freeze control No control function																														
2. Fan	Indoor fan operation controlled depends on the compressor conditions. <table border="1"> <thead> <tr> <th>Dry thermo</th> <th colspan="2">Fan speed notch</th> </tr> </thead> <tbody> <tr> <td>ON</td> <td colspan="2">[Low]</td> </tr> <tr> <td rowspan="2">OFF</td> <td>Excluding the following</td> <td>Stop</td> </tr> <tr> <td>Room temp. < 64°F</td> <td>[Low]</td> </tr> </tbody> </table> Note: Fan speed change is not allowed during DRYING operation.	Dry thermo	Fan speed notch		ON	[Low]		OFF	Excluding the following	Stop	Room temp. < 64°F	[Low]																			
Dry thermo	Fan speed notch																														
ON	[Low]																														
OFF	Excluding the following	Stop																													
	Room temp. < 64°F	[Low]																													
3. Drain pump	Operates as it would in COOL operation.																														
4. Vane (up/down vane change)	Settings are the same in DRYING operation as they are in COOL operation.																														

8-3. FAN OPERATION

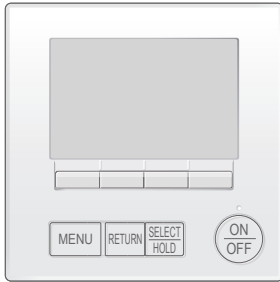

<How to operate>
 1 Press ON/OFF button.
 2 Press [F1] button to display FAN.

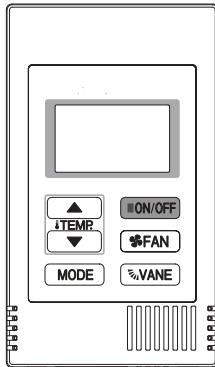

<How to operate>
 1 Press POWER ON/OFF button.
 2 Press the operation MODE button to display FAN.

Control Mode	Control Details	Remarks				
1. Temperature adjustment function	Set by remote controller. <table border="1" style="width: 100%;"> <thead> <tr> <th>Type</th> <th>Fan speed notch</th> </tr> </thead> <tbody> <tr> <td>3 speeds + Auto type</td> <td> </td> </tr> </tbody> </table> When [Auto] is set, fan speed becomes [Low].	Type	Fan speed notch	3 speeds + Auto type		
Type	Fan speed notch					
3 speeds + Auto type						
2. Drain pump	2-1. Drain pump control The drain pump turns ON for the specified amount of time when any of the following conditions has been satisfied: 1 ON for 3 minutes after the operation mode is switched from COOL or DRYING to another operation mode (FAN). 2 ON for 6 minutes after the float switch is submerged in the water when the float switch control judges the sensor is in the water. 2-2. Float switch control • Float switch control judges whether the sensor is in the air or in the water by turning the float switch ON/OFF. In the water : Detected that the float switch is ON for 15 seconds. In the air : Detected that the float switch is OFF for 15 seconds.	• Operates as it would in COOL operation.				
3. Vane (up/down vane change)	Same as the control performed during the COOL operation, but with no restriction on the vane's downward blow setting					

8-4. HEAT OPERATION

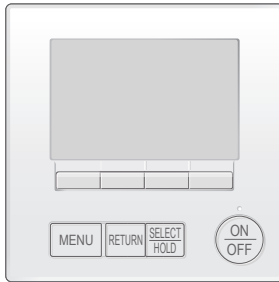

<How to operate>

- 1 Press ON/OFF button.
- 2 Press [F1] button to display HEAT.
- 3 Press [F2] [F3] button to set the set temperature.

NOTE: The settable temperature range varies with the model of outdoor units and remote controller.

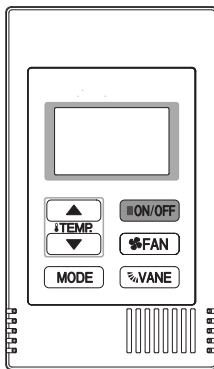

<How to operate>

- 1 Press POWER ON/OFF button.
- 2 Press the operation MODE button to display HEAT.
- 3 Press the TEMP. button to set the set temperature.

NOTE: The set temperature changes 1°F when the ∇ or Δ button is pressed one time. Heating 63 to 83°F

Control Mode	Control Details	Remarks				
1. Temperature adjustment function	1-1. Determining temperature adjustment function (Function to prevent restarting for 3 minutes) <ul style="list-style-type: none"> • Room temperature \leq Set temperature - 1°F ...Thermo-ON • Room temperature \geq Set temperature + 1°F ...Thermo-OFF 					
2. Fan	By the remote controller setting (switch of 4 speeds+Auto) <table border="1" style="margin: 10px auto; width: 80%;"> <thead> <tr> <th>Type</th> <th>Fan speed notch</th> </tr> </thead> <tbody> <tr> <td>3 speeds + Auto type</td> <td> </td> </tr> </tbody> </table> <p>When [Auto] is set, fan speed is changed depending on the value of: $\Delta T = \text{Set temperature} - \text{Room temperature}$</p> <p>Give priority to under-mentioned controlled mode</p> <ol style="list-style-type: none"> 2-1. Hot adjust mode 2-2. Residual heat exclusion mode 2-3. Thermo-OFF mode (When the compressor off by the temperature adjustment function) 2-4. Cool air prevention mode (Defrosting mode) 	Type	Fan speed notch	3 speeds + Auto type		
Type	Fan speed notch					
3 speeds + Auto type						

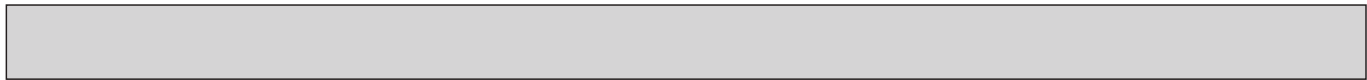

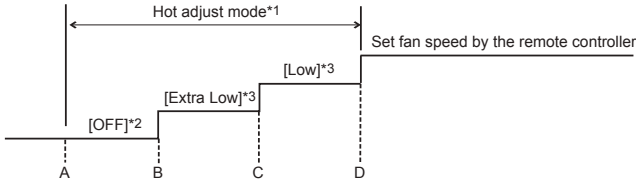
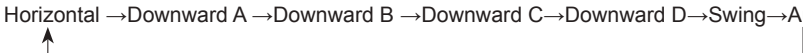
Control Mode	Control Details	Remarks													
	<p>2-1. Hot adjust mode</p> <p>The fan controller becomes the hot adjuster mode for the following conditions.</p> <ol style="list-style-type: none"> 1 When starting the HEAT operation 2 When the temperature adjustment function changes from OFF to ON. 3 When release the HEAT defrosting operation  <p>A: Hot adjust mode starts. B: 5 minutes have passed since the condition A or the indoor liquid pipe temperature reached 86°F or more. C: 5 minutes have passed since the condition A or the indoor liquid pipe temperature reached 95°F or more. D: 2minutes have passed since the condition C. (Terminating the hot adjust mode)</p> <table border="1" data-bbox="805 719 1359 898"> <thead> <tr> <th colspan="2" rowspan="2"></th> <th colspan="2">DIP SW 1-8</th> </tr> <tr> <th>ON</th> <th>OFF</th> </tr> </thead> <tbody> <tr> <th rowspan="2">DIP SW 1-7</th> <th>ON</th> <td>B to C [Extra Low] C to D [Low]</td> <td>B to C [Low] C to D [Low]</td> </tr> <tr> <th>OFF</th> <td>B to C [Setting airflow] C to D [Setting airflow]</td> <td>B to C [Extra Low] C to D [Low] Note: Initial setting</td> </tr> </tbody> </table>			DIP SW 1-8		ON	OFF	DIP SW 1-7	ON	B to C [Extra Low] C to D [Low]	B to C [Low] C to D [Low]	OFF	B to C [Setting airflow] C to D [Setting airflow]	B to C [Extra Low] C to D [Low] Note: Initial setting	<p>*1 "Heat Standby" will be displayed during the hot adjust mode.</p> <p>*2 The step change of A to B will not be performed at the first thermo-ON mode since the HEAT operation has started.</p> <p>*3 The fan speed varies according to the setting of DIP SW1-7 and 1-8 as shown in the table below.</p>
				DIP SW 1-8											
		ON	OFF												
DIP SW 1-7	ON	B to C [Extra Low] C to D [Low]	B to C [Low] C to D [Low]												
	OFF	B to C [Setting airflow] C to D [Setting airflow]	B to C [Extra Low] C to D [Low] Note: Initial setting												
	<p>2-2. Residual heat exclusion mode</p> <p>When the condition changes the auxiliary heater ON to OFF (temperature adjustment function, or operation stop, etc.), the indoor fan operates in [Low] mode for 1 minute.</p>	<p>• This control is same for the model without auxiliary heater.</p>													
	<p>2-3. Thermo-OFF mode</p> <p>When the temperature adjustment function changes to OFF, the indoor fan operates in [Extra low].</p>														
	<p>2-4. Heat defrosting mode</p> <p>The indoor fan stops.</p>														
<p>3. Drain pump</p>	<p>3-1. Drain pump control</p> <p>The drain pump turns ON for the specified amount of time when any of the following conditions has been satisfied:</p> <ol style="list-style-type: none"> 1 ON for 3 minutes after the operation mode is switched from COOL or DRYING to another operation mode (FAN). 2 ON for 6 minutes after the float switch is submerged in the water when the float switch control judges the sensor is in the water. 														
	<p>3-2. Float switch control</p> <ul style="list-style-type: none"> • Float switch control judges whether the sensor is in the air or in the water by turning the float switch ON/OFF. <p>In the water: Detected that the float switch is ON for 15 seconds. In the air : Detected that the float switch is OFF for 15 seconds.</p>	<p>• Operates as it would in COOL operation.</p>													
<p>4. Vane control (Up/down vane change)</p>	<p>(1) Initial setting: OFF → HEAT…[last setting] When the last setting is [Swing] … [Downward D] When changing the mode from exception of HEAT to HEAT operation …[Downward D]</p> <p>(2) Vane position: Horizontal →Downward A →Downward B →Downward C→Downward D→Swing→Auto</p>  <p>(3) Restriction of vane position</p> <ol style="list-style-type: none"> 1 The vane is horizontally fixed for the following modes. (The control by the remote controller is temporally invalidated and control by the unit.) <ul style="list-style-type: none"> • Thermo-OFF • Hot adjust [Extra low] mode • Heat defrost mode 														

8-5. AUTO OPERATION [AUTOMATIC COOL/HEAT CHANGE OVER OPERATION]

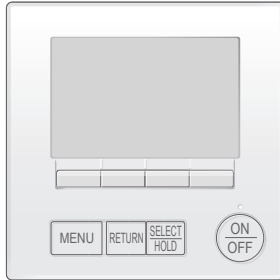

<How to operate>

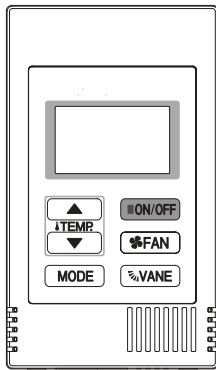

- 1 Press ON/OFF button.
- 2 Press [F1] button to display AUTO.
- 3 Press [F2] [F3] button to set the set temperature.

NOTE: The settable temperature range varies with the model of outdoor units and remote controller.



<How to operate>

- 1 Press POWER ON/OFF button.
- 2 Press the operation MODE button to display AUTO.
- 3 Press the TEMP. button to set the set temperature.

NOTE: The set temperature changes 1°F when the  or  button is pressed one time. Automatic 67 to 83°F

Control Mode	Control Details	Remarks
1. Initial value of operation mode	HEAT mode for room temperature < Set temperature COOL mode for room temperature ≥ Set temperature	
2. Mode change	(1) HEAT mode → COOL mode Room temperature ≥ Set temperature + 3°F or 3 minutes have passed. (2) COOL mode → HEAT mode Room temperature ≤ Set temperature - 3°F or 3 minutes have passed.	
3. COOL mode	Operates as it would in COOL operation.	
4. HEAT mode	Operates as it would in HEAT operation.	

8-6. WHEN UNIT IS STOPPED CONTROL MODE

Control Mode	Control Details	Remarks
1. Drain pump	1-1. Drain pump control The drain pump turns ON for the specified amount of time when any of the following conditions has been satisfied: 1 ON for 3 minutes after the operation mode is switched from COOL or DRYING to another operation mode (FAN). 2 ON for 6 minutes after the float switch is submerged in the water when the float switch control judges the sensor is in the water.	
	1-2. Float switch control • Float switch control judges whether the sensor is in the air or in the water by turning the float switch ON/OFF. In the water : Detected that the float switch is ON for 15 seconds. In the air : Detected that the float switch is OFF for 15 seconds.	• Operates as it would in COOL operation.

9-1. COUNTERMEASURES FOR ERROR DURING TEST RUN

If a problem occurs during test run, a code number will appear on the remote controller (or LED on the outdoor unit), and the air conditioning system will automatically cease operating.

Refer to the connected outdoor unit service manual in order to determine the nature of the abnormality and apply corrective measure.

Check code	Trouble	Detected Unit			Remarks
		Indoor	Outdoor	Remote Controller	
0403	Serial communication error/Model selection SW error		○		Outdoor unit Multi controller board ~ Power board communication trouble
1102	Compressor temperature		○		Check delay code 1202
1300	Low pressure		○		
1302	High pressure		○		Check delay code 1402
1500	Superheat due to low discharge temperature		○		Check delay code 1600
1501	Refrigerant shortage		○		Check delay code 1601
	Closed valve in cooling mode		○		Check delay code 1501
1503	Freeze protection of branch box or indoor unit		○		
1508	4-way valve trouble in heating mode		○		Check delay code 1608
1521	Refrigerant leakage	○			
1522	Refrigerant leakage or refrigerant sensor error	○			
2500	Water leakage	○			
2502	Drain overflow protection	○			
2503	Drain sensor abnormality	○			
4100	Compressor current interruption (locked compressor)		○		Check delay code 4350
4114	Fan motor error	○			
4210	Compressor overcurrent interruption		○		
4220	Undervoltage/overvoltage/PAM error/L1open phase/power synchronization signal error		○		Check delay code 4320
4230	Heat Sink temperature		○		Check delay code 4330
4250	Power module		○		Check delay code 4350
4400	Fan trouble		○		Check delay code 4500
5101	Air inlet thermistor (TH21) open/short	○			
	Compressor temperature thermistor (TH4) open/short		○		Check delay code 1202
5102	Liquid pipe temperature thermistor (TH22) open/short	○			
	Suction pipe temperature thermistor (TH6) open/short		○		Check delay code 1211
5103	Gas pipe temperature thermistor (TH23) open/short	○			
5105	Outdoor liquid pipe temperature thermistor (TH3) open/short		○		Check delay code 1205
5106	Ambient thermistor (TH7) open/short		○		Check delay code 1221
5109	HIC pipe temperature thermistor (TH2) open/short		○		Check delay code 1222
5110	Heat Sink temperature thermistor (TH8) open/short		○		Check delay code 1214
5201	High pressure sensor (63HS)		○		Check delay code 1402
5202	Low pressure sensor (63LS)		○		Check delay code 1400
5558	Refrigerant sensor error	○			
5701	Contact failure of drain float switch	○			
6600	Duplex address error	○	○	○	Only M-NET Remote controller is detected.
6602	Transmission processor hardware error	○	○	○	Only M-NET Remote controller is detected.
6603	Transmission bus BUSY error	○	○	○	Only M-NET Remote controller is detected.
6606	Signal communication error with transmission processor	○	○	○	Only M-NET Remote controller is detected.
6607	No ACK error	○		○	Only M-NET Remote controller is detected. *
6608	No response frame error	○		○	Only M-NET Remote controller is detected. *
6815	MA supervisor remote controller communication error	○			
6831	MA communication receive error (no receive signal)	○		○	Only MA Remote controller is detected.
6832	MA communication send error	○		○	Only MA Remote controller is detected.
6833	MA communication send error	○		○	Only MA Remote controller is detected.
6834	MA communication receive error	○		○	Only MA Remote controller is detected.
7100	Total capacity error		○		
7101	Capacity code error	○	○		
7102	Connecting excessive number of units		○		
7105	Address setting error		○		
7118	Refrigerant leak detection system error		○		
7123	Alarm Kit connection error	○	○		
7130	Incompatible unit combination		○		

Note:
When the outdoor unit detects No ACK error/No response error, an object indoor unit is treated as a stop, and not assumed to be abnormal.

9-2. HOW TO CHECK THE PARTS

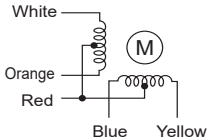
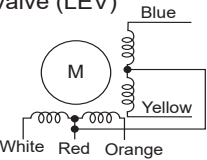
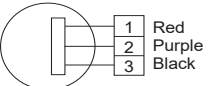
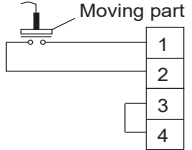
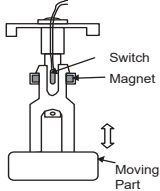
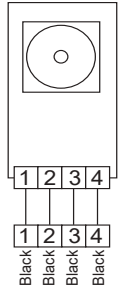
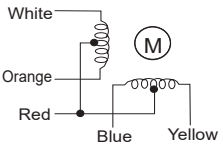
Parts name	Checkpoints														
Thermistor (TH21) (Room temperature detection) Thermistor (TH22) (Pipe temperature detection/Liquid) Thermistor (TH23) (Pipe temperature detection/Gas)	Disconnect the connector then measure the resistance with a multimeter. (At the ambient temperature 50 to 86°F) <table border="1" style="margin-left: 20px;"> <tr> <th>Normal</th> <th>Abnormal</th> </tr> <tr> <td>4.3 to 9.6 kΩ</td> <td>Open or short</td> </tr> </table> Refer to "9-2-1. Thermistor Characteristic Graph".	Normal	Abnormal	4.3 to 9.6 kΩ	Open or short										
Normal	Abnormal														
4.3 to 9.6 kΩ	Open or short														
Vane motor (MV) 	Measure the resistance between the terminals with a multimeter. (At the ambient temperature 68 to 86°F) <table border="1" style="margin-left: 20px;"> <tr> <th colspan="4">Normal</th> <th>Abnormal</th> </tr> <tr> <td>Red–Yellow</td> <td>Red–Blue</td> <td>Red–Orange</td> <td>Red–White</td> <td rowspan="2">Open or short</td> </tr> <tr> <td colspan="4" style="text-align: center;">300 Ω</td> </tr> </table>	Normal				Abnormal	Red–Yellow	Red–Blue	Red–Orange	Red–White	Open or short	300 Ω			
Normal				Abnormal											
Red–Yellow	Red–Blue	Red–Orange	Red–White	Open or short											
300 Ω															
Linear expansion valve (LEV) 	Disconnect the connector then measure the valve resistance with a multimeter. <table border="1" style="margin-left: 20px;"> <tr> <th colspan="4">Normal</th> <th>Abnormal</th> </tr> <tr> <td>White-Red</td> <td>Yellow-Red</td> <td>Orange-Red</td> <td>Blue-Red</td> <td rowspan="2">Open or short</td> </tr> <tr> <td colspan="4" style="text-align: center;">150 Ω ±10%</td> </tr> </table> Refer to "9-2-2. Linear Expansion Valve".	Normal				Abnormal	White-Red	Yellow-Red	Orange-Red	Blue-Red	Open or short	150 Ω ±10%			
Normal				Abnormal											
White-Red	Yellow-Red	Orange-Red	Blue-Red	Open or short											
150 Ω ±10%															
Drain pump (DP) 	<ol style="list-style-type: none"> ① Check if the drain float switch works properly. ② Check if the drain pump works and drains water properly in cooling operation. ③ If no water drains, confirm that the check code 2502 will not be displayed 10 minutes after the operation starts. Note: The drain pump for this model is driven by the control board and is a DC volt motor, so it is not possible to measure the resistance between the terminals. Normal Red–Black: Input 13 V DC → The pump starts to rotate. Purple–Black: Abnormal (check code 2502) if it outputs 0–13 V square wave (5 pulses/rotation), and the number of rotation is not normal.														
Drain float switch (FS) 	Measure the resistance between the terminals with a multimeter. <table border="1" style="margin-left: 20px;"> <tr> <th>State of moving part</th> <th>Normal</th> <th>Abnormal</th> </tr> <tr> <td>UP</td> <td>Short</td> <td>Other than short</td> </tr> <tr> <td>DOWN</td> <td>Open</td> <td>Other than open</td> </tr> </table> 	State of moving part	Normal	Abnormal	UP	Short	Other than short	DOWN	Open	Other than open					
State of moving part	Normal	Abnormal													
UP	Short	Other than short													
DOWN	Open	Other than open													
i-see sensor * 	Turn the power ON while the i-see sensor connector is connected to the CN4Z on indoor controller board. A communication between the indoor controller board and i-see sensor board is made to detect the connection. Normal: When the operation starts, the motor for i-see sensor is driven to rotate the i-see sensor. Abnormal: The motor for i-see sensor is not driven when the operation starts. Note: The voltage between the terminals cannot be measured accurately since it is pulse output.														
i-see sensor motor * 	Measure the resistance between the terminals with a multimeter. (At the ambient temperature 68 to 86°F) <table border="1" style="margin-left: 20px;"> <tr> <th colspan="4">Normal</th> <th>Abnormal</th> </tr> <tr> <td>Red–Yellow</td> <td>Red–Blue</td> <td>Red–Orange</td> <td>Red–White</td> <td rowspan="2">Open or short</td> </tr> <tr> <td colspan="4" style="text-align: center;">250 Ω</td> </tr> </table>	Normal				Abnormal	Red–Yellow	Red–Blue	Red–Orange	Red–White	Open or short	250 Ω			
Normal				Abnormal											
Red–Yellow	Red–Blue	Red–Orange	Red–White	Open or short											
250 Ω															

* i-see sensor is available with optional "i-see sensor corner panel" (SLP-18FAEU).

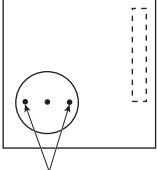
Parts name	Checkpoints				
Refrigerant sensor	<p>Measure the resistance between the terminals with a multimeter.</p> <table border="1"> <thead> <tr> <th>Normal</th> <th>Abnormal</th> </tr> </thead> <tbody> <tr> <td>Below 10 Ω</td> <td>Open (10 Ω or more)</td> </tr> </tbody> </table> <p>After turning off the indoor unit breaker and leaving it for 5 minutes, measure the resistance value between the sensor terminals. < Back side of the sensor ></p>  <p>Measure the both sides of the sensor pin.</p>	Normal	Abnormal	Below 10 Ω	Open (10 Ω or more)
Normal	Abnormal				
Below 10 Ω	Open (10 Ω or more)				

9-2-1. Thermistor Characteristic Graph

<Thermistor characteristic graph>

Thermistors for lower temperature

Room temperature detection thermistor (TH21)
 Pipe temperature detection thermistor/liquid (TH22)
 Pipe temperature detection thermistor/gas (TH23)

Thermistor $R_0=15\text{ k}\Omega \pm 3\%$
 Fixed number of $B=3480 \pm 2\%$

$$R_t = 15 \exp \left\{ 3480 \left(\frac{1}{273 + (t-32)/1.8} - \frac{1}{273} \right) \right\}$$

30°F	15.8 kΩ
50°F	9.6 kΩ
70°F	6.0 kΩ
80°F	4.8 kΩ
90°F	3.9 kΩ
100°F	3.2 kΩ

< Thermistor for lower temperature >

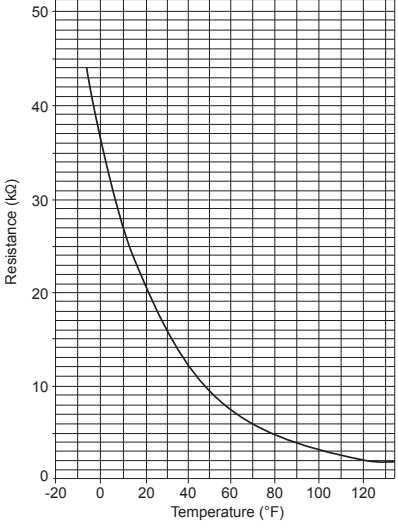

9-2-2. Linear Expansion Valve

① Operation summary of the linear expansion valve

- Linear expansion valves open/close through the use of a stepping motor after receiving the pulse signal from the indoor controller board.
- Valve position can be changed in proportion to the number of pulse signals.

<Connection between the indoor controller board and the linear expansion valve>

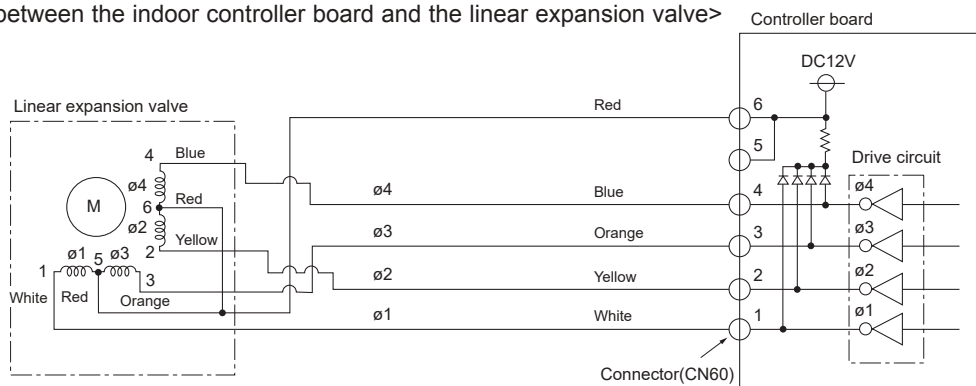

Note : Since the order of connector numbers is different at the controller board side from the LEV side, see the colors of lead wires to check the numbers.

<Output pulse signal and the valve operation>

Output (Phase)	Output			
	1	2	3	4
ø1	ON	OFF	OFF	ON
ø2	ON	ON	OFF	OFF
ø3	OFF	ON	ON	OFF
ø4	OFF	OFF </td <td>ON</td> <td>ON</td>	ON	ON

② Linear expansion valve operation

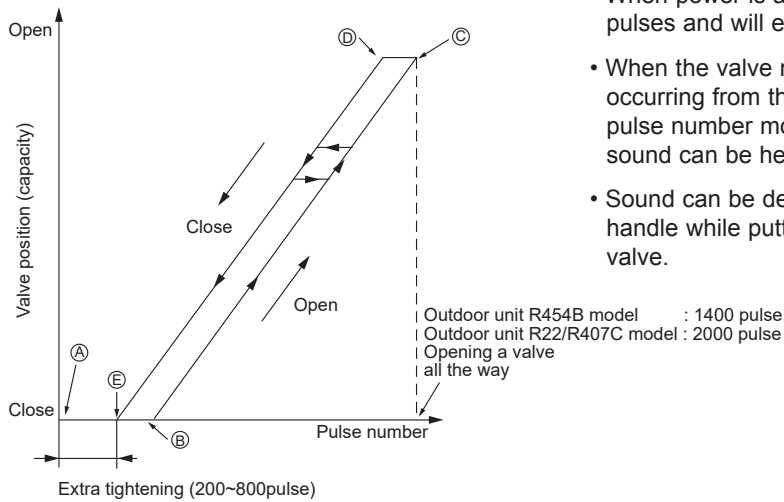

Closing a valve : 1 → 2 → 3 → 4 → 1
 Opening a valve : 4 → 3 → 2 → 1 → 4

The output pulse shifts in above order.

- When linear expansion valve operation stops, all output phases become OFF.
- At phase interruption or when phase does not shift in order, motor does not rotate smoothly and motor will lock and vibrate.
- When power is applied valve drives in the closed direction 2200 pulses and will end at A. This is done to define valve position.
- When the valve moves smoothly, there is no sound or vibration occurring from the linear expansion valves : however, when the pulse number moves from E to A or when the valve is locked, more sound can be heard than in a normal situation.
- Sound can be detected by placing the ear against the screw driver handle while putting the screw driver tip to the linear expansion valve.

③ Troubleshooting

Symptom	Check points	Countermeasures
Operation circuit failure of the micro processor	Disconnect the connector on the controller board, then connect LED for checking. When power is turned on, pulse signals will be output for 10 seconds. There must be some defects in the operation circuit if the LED does not light while the signals are output or keeps lighting even after the signals stop.	Exchange the indoor controller board at drive circuit failure.
Linear expansion valve mechanism is locked.	Motor will idle and make a ticking noise when the motor is operated while the linear expansion valve is locked. This ticking sound is the sign of the abnormality.	Exchange the linear expansion valve.
Short or breakage of the motor coil of the linear expansion valve	Measure the resistance between each coil (white-red, yellow red, orange-red, blue-red) with a multimeter. It is normal if the resistance is in the range of $150 \Omega \pm 10\%$.	Exchange the linear expansion valve.
Valve does not close completely.	To check the linear expansion valve, operate the indoor unit in fan mode and at the same time operate other indoor units in cooling mode, then check the pipe temperature <liquid pipe temperature> of the indoor unit by the outdoor multi controller board operation monitor. During fan operation, linear expansion valve is closed completely and if there is any leaking, detecting temperature of the thermistor will go lower. If the detected temperature is much lower than the temperature indicated in the remote controller, it means the valve is not closed all the way. It is not necessary to exchange the linear expansion valve, if the leakage is small and not affecting normal operation. 	If large amount of refrigerant leaks, exchange the linear expansion valve.
Wrong connection of the connector or contact failure	Check the color of lead wire and missing terminal of the connector.	Disconnect the connector at the controller board, then check the continuity.

9-2-3. DC Fan Motor (Fan Motor/Indoor Controller Board)

Check method of indoor fan motor (fan motor/indoor controller board)

① Notes

- High voltage is applied to the connector (CNMF) for the fan motor. Pay attention to the service.
- Do not pull out the connector (CNMF) for the motor with the power supply on.
(It will damage the indoor controller board and fan motor)

② Self check

Conditions : The indoor fan cannot turn around.

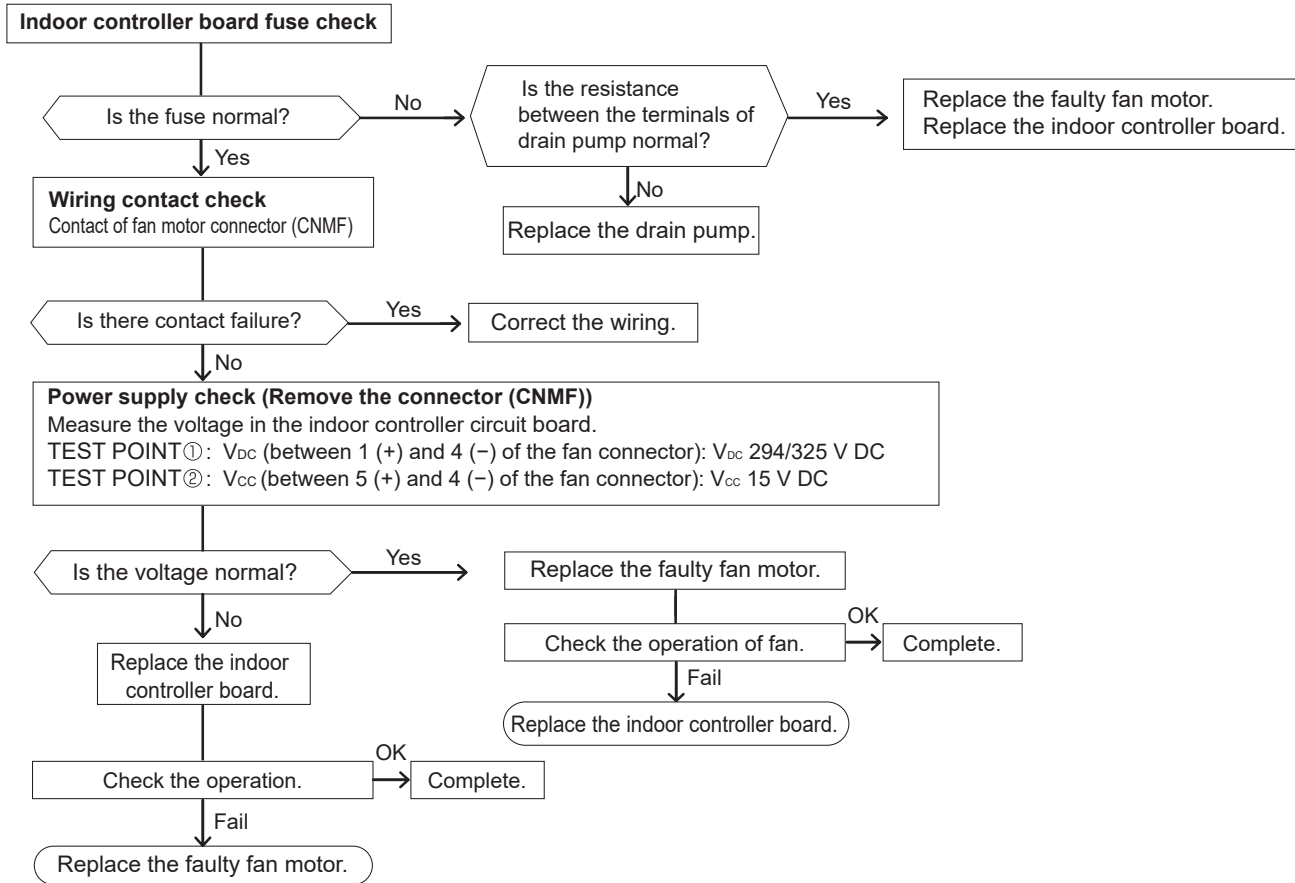

9-2-4. Refrigerant sensor

Check code	Refrigerant leakage
1521/1522 (FL)	

Abnormal points and detection methods	Causes and checkpoints
Refrigerant is leaking from the air conditioner. The refrigerant sensor has detected refrigerant leak. Refrigerant is leaking in the room where the alarm is beeping. (Optional) A refrigerant sensor has failed.	<ul style="list-style-type: none"> Refrigerant leak from air conditioner Refrigerant leak from piping False detection (The refrigerant sensor reacted to other gas.)

Notes:

- When this error occurs, both of the alarm in the applicable room and the supervisor mode alarm beep. Also, the system closes the shut-off valve and performs refrigerant recovery.
- When this error occurs, ventilate the room.
- When this error occurs, do not turn off the power until the fan in the outdoor unit stops.

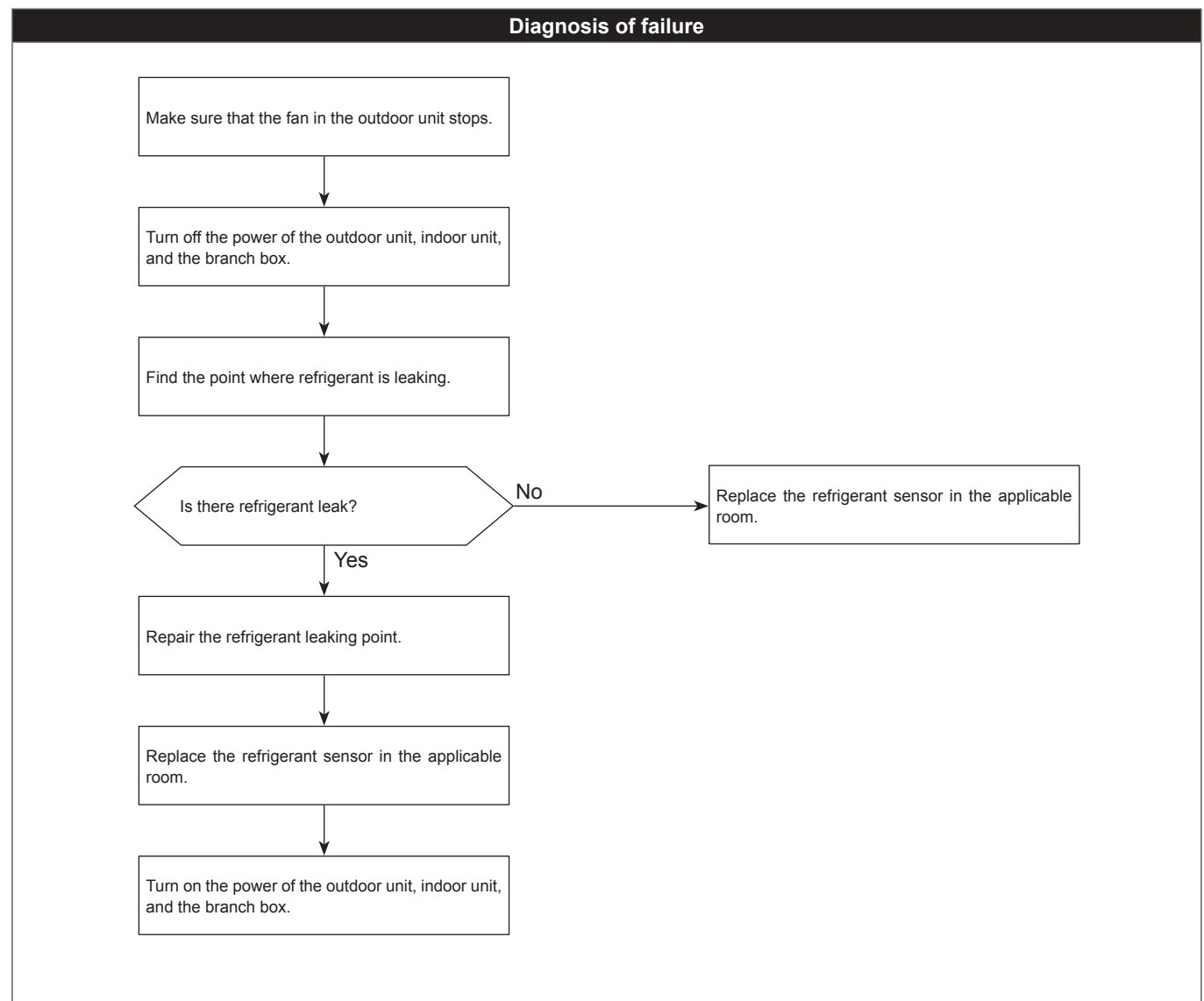

Check code

5558
(FH)

Refrigerant sensor error

Abnormal points and detection methods	Causes and checkpoints
A refrigerant sensor has failed.	<ul style="list-style-type: none">• A refrigerant sensor connected to an M-IC has failed.• A Sensor and Alarm Kit connected to a branch box has failed.

Diagnosis of failure

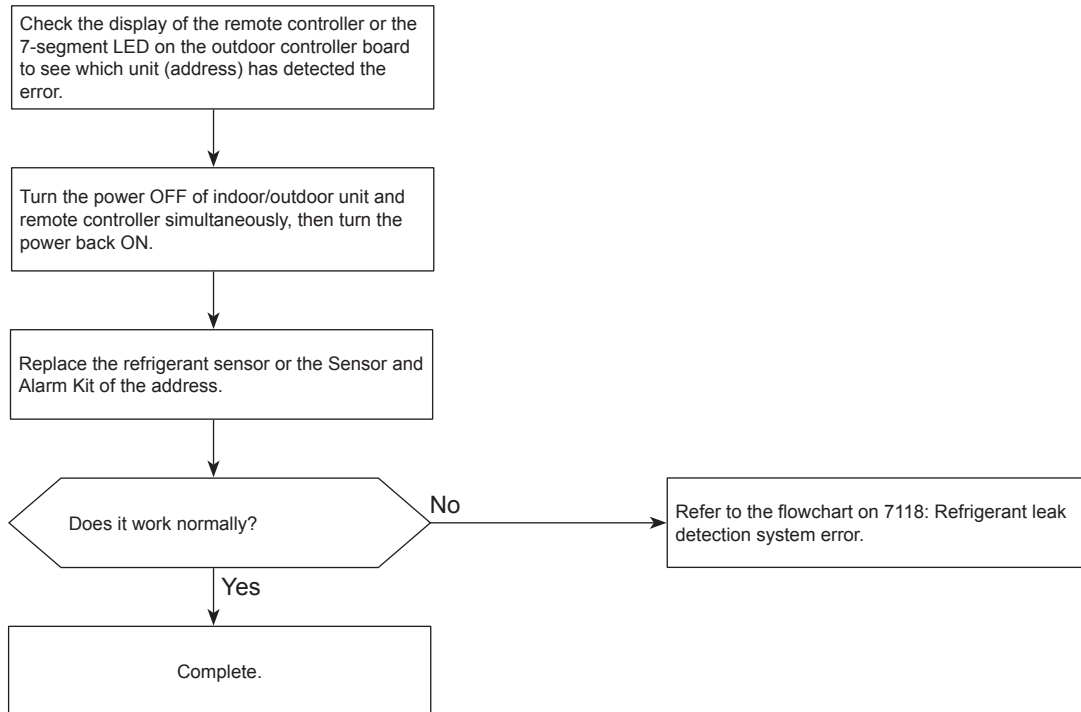

9-3. FUNCTION OF DIP SWITCH

Switch	Pole	Function	Operation by switch		Effective timing	Remarks																		
			ON	OFF																				
SW1 Function Selection	1	Thermistor <Room temperature detection> position	Built-in remote controller	Indoor unit	Under suspension	<Initial setting> 																		
	2	Filter clogging detection	Provided	Not provided																				
	3	Filter cleaning	2,500h	100h																				
	4	Fresh air intake	Effective	Not effective																				
	5	Remote indication switching	Thermo ON signal indication	Fan output indication																				
	6	—	—	—																				
	7	Air flow set in case of Heat thermo OFF	Low *1	Extra low *1																				
	8	Auto restart function	Effective	Not effective																				
	9	Power ON/OFF	Effective	Not effective																				
	0	Power ON/OFF	Effective	Not effective																				
SW2 Capacity code setting	1-6	<table border="1"> <thead> <tr> <th>Capacity</th> <th>SW 2</th> <th>Capacity</th> <th>SW 2</th> <th>Capacity</th> <th>SW 2</th> </tr> </thead> <tbody> <tr> <td>05</td> <td></td> <td>12</td> <td></td> <td>18</td> <td></td> </tr> <tr> <td>08</td> <td></td> <td>15</td> <td></td> <td></td> <td></td> </tr> </tbody> </table>	Capacity	SW 2	Capacity	SW 2	Capacity	SW 2	05		12		18		08		15						Before power supply ON	<Initial setting> Set for each capacity.
Capacity	SW 2	Capacity	SW 2	Capacity	SW 2																			
05		12		18																				
08		15																						
SW3 Function setting	1	Heat pump/Cooling only	Cooling only	Heat pump	Under suspension	<Initial setting> Set for each capacity. 																		
	2	—	—	—																				
	3	—	—	—																				
	4	Setting i-see Sensor installation position	Setting pattern ③	Setting pattern ①																				
	5	Vane horizontal angle	Second setting	First setting																				
	6	—	—	—																				
	7	Indoor linear expansion valve opening	Effective	Not effective																				
	8	Heat 4 degrees up	Not effective	Effective																				
	9	—	—	—																				
	0	—	—	—																				
SW11 1s digit address setting SW12 10s digit address setting	Rotary switch	 SW11 1s DIGIT	 SW12 10s DIGIT	Address setting should be done when M-NET remote controller is being used.	Before power supply ON	<Initial setting> 																		
SW14 Branch No. setting	Rotary switch	 SW14	This is the switch to be used when the indoor unit is operated with R2 series outdoor unit as a set. With other than R2 series outdoor unit leave at 0.	Before power supply ON	<Initial setting> SW14 																			

*1 Refer to the <Table A> below.

<Table A>



SW1-7	SW1-8	
OFF	OFF	Extra low
ON	OFF	Low
OFF	ON	Setting air flow
ON	ON	stop

Continue to the next page

Switch	Pole	Function	Operation by switch		Effective timing	Remarks
			ON	OFF		
SW21 Function selection	1	Setting ceiling height	Depends on SW21-1, SW21-2		Under operation or suspension	<Initial setting> ON <input type="checkbox"/> <input type="checkbox"/> <input type="checkbox"/> <input type="checkbox"/> <input type="checkbox"/> <input type="checkbox"/> OFF <input type="checkbox"/> <input type="checkbox"/> <input type="checkbox"/> <input type="checkbox"/> <input type="checkbox"/> <input type="checkbox"/> 1 2 3 4 5 6
	2					
	3	—	—			
	4	—	—			
	5	—	—			
	6	—	—			

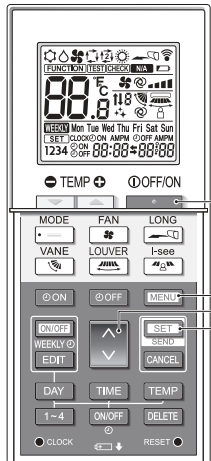
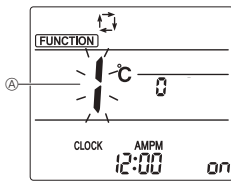
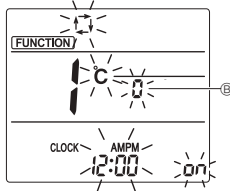
	SW21-1	SW21-2	Height
Silent	—	ON	8.2 ft [2.5 m]
Standard	OFF	OFF	8.9 ft [2.7 m] (default setting)
High	ON	OFF	9.8 ft [3.0 m]

Switch	Pole	Function	Operation by switch		Effective timing	Remarks																				
			ON	OFF																						
SW22 Function selection	Jumper	<table border="1"> <thead> <tr> <th></th> <th>Function</th> <th>ON</th> <th>OFF</th> </tr> </thead> <tbody> <tr> <td>1</td> <td>—</td> <td>—</td> <td>—</td> </tr> <tr> <td>2</td> <td>—</td> <td>—</td> <td>—</td> </tr> <tr> <td>3</td> <td>Pair No. of wireless remote controller</td> <td colspan="2" rowspan="2">Depends on SW22-3, 22-4</td> </tr> <tr> <td>4</td> <td>Pair No. of wireless remote controller</td> </tr> </tbody> </table>		Function	ON	OFF	1	—	—	—	2	—	—	—	3	Pair No. of wireless remote controller	Depends on SW22-3, 22-4		4	Pair No. of wireless remote controller			Under operation or suspension	<Initial setting>   Fig. 1  Fig. 2		
			Function	ON	OFF																					
1	—	—	—																							
2	—	—	—																							
3	Pair No. of wireless remote controller	Depends on SW22-3, 22-4																								
4	Pair No. of wireless remote controller																									
<ul style="list-style-type: none"> To operate each indoor unit by each remote controller when installed 2 indoor units or more are near, Pair No. setting is necessary. <ul style="list-style-type: none"> Pair No. setting is available with the 4 patterns (Setting patterns A to D). Make setting for J41, J42 of indoor controller board and the Pair No. of wireless remote controller. You may not set it when operating it by one remote controller. <ul style="list-style-type: none"> Setting for indoor unit Cut jumper wire J41, J42 on the indoor controller board according to the table below. <p>Wireless remote controller pair number:</p> <ul style="list-style-type: none"> Setting operation (Fig. 1 (A)) <ol style="list-style-type: none"> Press the button ① to stop the air conditioner. Press the button ②. Check that function No."1" is displayed, and then press the button ③. The Screen display setting screen will be displayed. (Fig. 2.) Pair No. changing operation (Fig. 2 (B)) <ol style="list-style-type: none"> Press the button ④. Each time the button ④ is pressed, the pair No.0-3 changes. Press the button ③ to check the setting. Press the button ②. <table border="1"> <thead> <tr> <th colspan="2">Indoor unit SW22</th> <th colspan="2">Pair No. of wireless remote controller</th> </tr> <tr> <th>SW22-3</th> <th>SW22-4</th> <th></th> <th></th> </tr> </thead> <tbody> <tr> <td>ON</td> <td>ON</td> <td>0</td> <td>Initial setting</td> </tr> <tr> <td>OFF</td> <td>ON</td> <td>1</td> <td>—</td> </tr> <tr> <td>ON</td> <td>OFF</td> <td>2</td> <td>—</td> </tr> <tr> <td>OFF</td> <td>OFF</td> <td>3-9</td> <td>—</td> </tr> </tbody> </table>	Indoor unit SW22		Pair No. of wireless remote controller		SW22-3	SW22-4			ON	ON	0	Initial setting	OFF	ON	1	—	ON	OFF	2	—	OFF	OFF	3-9	—		
Indoor unit SW22		Pair No. of wireless remote controller																								
SW22-3	SW22-4																									
ON	ON	0	Initial setting																							
OFF	ON	1	—																							
ON	OFF	2	—																							
OFF	OFF	3-9	—																							

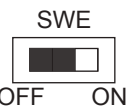
Switch	Pole	Function	Operation by switch		Effective timing	Remarks
			ON	OFF		
SWE Test run for Drain pump	Connector	<p>Drain pump and fan are activated simultaneously after the connector SWE is set to ON and turn on the power.</p> <div style="display: flex; justify-content: center; align-items: center;"> <div style="text-align: center;"> <p>SWE</p>  <p>OFF ON</p> </div> <div style="margin: 0 20px;">→</div> <div style="text-align: center;"> <p>SWE</p>  <p>OFF ON</p> </div> </div> <p>The connector SWE is set to OFF after test run.</p>			Under operation	<Initial setting>  OFF ON

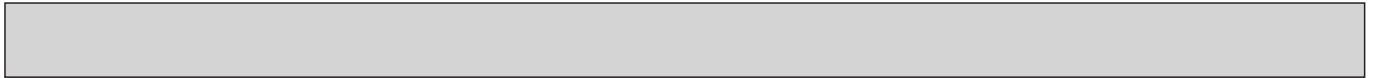

Switch	Pole	Function	Effective timing	Remarks	
CNSB Activation switch for CNSA refrigerant sensor	Short-circuit connector	It is to enable/disable the refrigerant sensor mounted to the indoor unit. If the indoor unit is installed in a large space, remove the short-circuit connector.		Before power supply ON (only for the first time)	<Initial setting> Short-circuit connector mounted
		Short-circuit connector	Refrigerant sensor mounted to the indoor unit		
External heater Switching the external heater output	Function setting	It is to switch permission/prohibition of the external heater output when the refrigerant sensor is in the abnormal state. Refer to the operation manual included in the remote controller for the setting.			
		Function setting No.171	External heater operation	Remarks	
		1	Permission		
		2	Prohibition	Initial setting	
15	Initializing this item				

9-4. TEST POINT DIAGRAM Indoor controller board

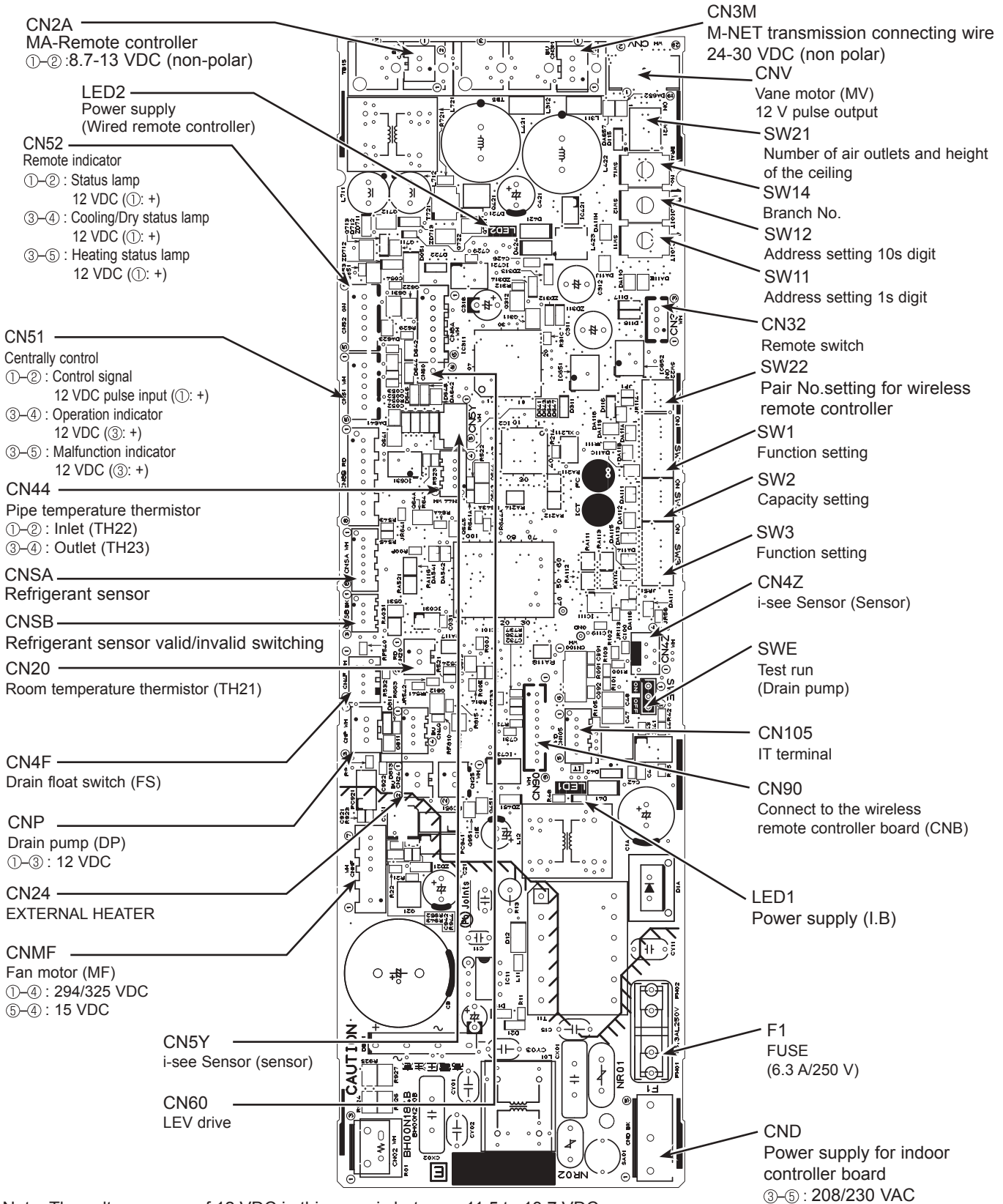

Note: The voltage range of 12 VDC in this page is between 11.5 to 13.7 VDC.

NOTE: Turn OFF the power supply before disassembly.
Be careful when removing heavy parts.

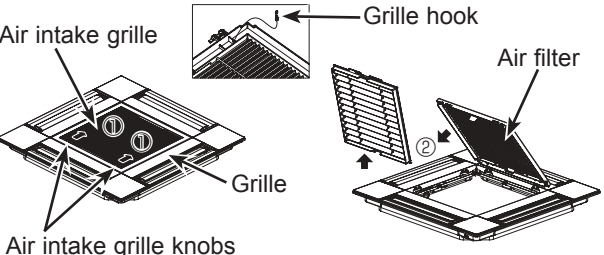
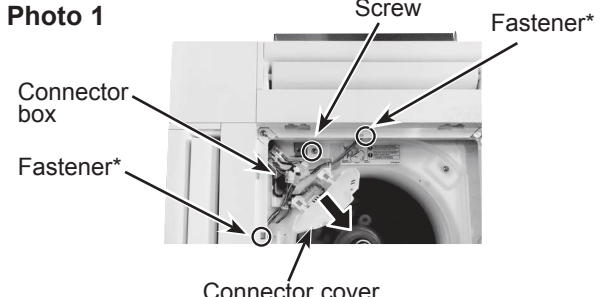
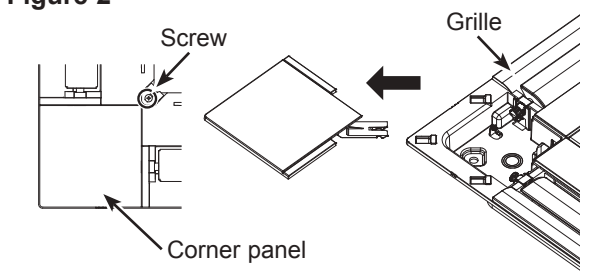
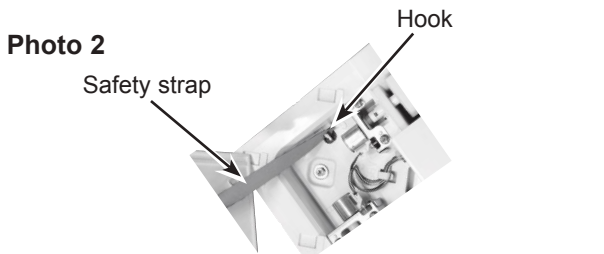
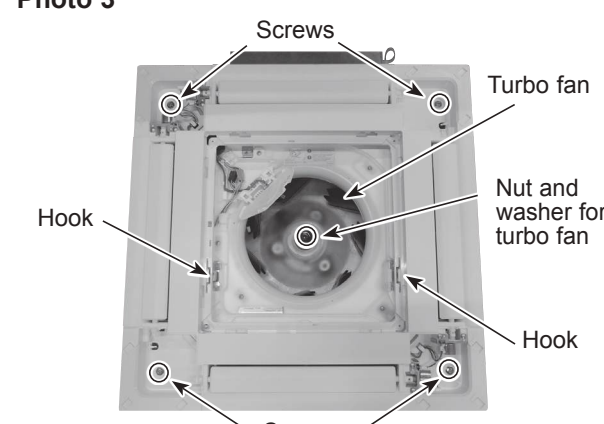
OPERATING PROCEDURE	PHOTOS/FIGURES
<p>1. Removing the air intake grille and air filter</p> <p>(1) Slide the knob of air intake grille to the direction of the arrow ① to open the air intake grille.</p> <p>(2) Remove the grille hook from the panel to prevent the grille from dropping.</p> <p>(3) Slide the hinge of the intake grille to the direction of the arrow ② and remove the air filter.</p>	<p>Figure 1</p>  <p>Air intake grille Grille hook Air filter Grille Air intake grille knobs</p>
<p>2. Removing the panel</p> <p>(1) Remove the air intake grille. (Refer to procedure 1)</p> <p>Connector box (See Photo 1)</p> <p>(2) Remove the screw of the connector cover.</p> <p>(3) Slide the connector cover to the direction of the arrow to open the cover.</p> <p>(4) Disconnect all the connectors, then pull out the connectors that are coming from panel side from the connector box.</p> <p>Corner panel (See Figure 2 and Photo 2)</p> <p>(5) Loosen the screw from the corner of the corner panel.</p> <p>(6) Slide the corner panel as indicated by the arrow.</p> <p>(7) Remove the safety strap from the hook, then remove the corner panel from the panel. (The safety strap is not equipped for the signal receiver panel and i-see Sensor corner panel.)</p> <p>(8) Remove the fastener (*), then remove the corner panel.</p> <p>Panel (See Photo 3)</p> <p>(9) Remove the 4 screws.</p> <p>(10) Unlatch the 2 hooks.</p> <p>* Fastener is only for the signal receiver and i-see Sensor corner panel.</p>	<p>Photo 1</p>  <p>Screw Fastener* Connector box Fastener* Connector cover</p> <p>Figure 2</p>  <p>Screw Grille Corner panel</p> <p>Photo 2</p>  <p>Hook Safety strap</p> <p>Photo 3</p>  <p>Screws Turbo fan Nut and washer for turbo fan Hook Hook Screws</p>



OPERATING PROCEDURE

PHOTOS/FIGURES

3. Removing the electrical parts

(1) Loosen the 2 screws on the control box cover.

(2) Slide the control box cover as indicated by the arrow to remove.

<Electrical parts in the control box>

- Indoor controller board (I.B)
- Terminal block (TB2)
- Terminal block (TB5)
- Terminal block (TB15)

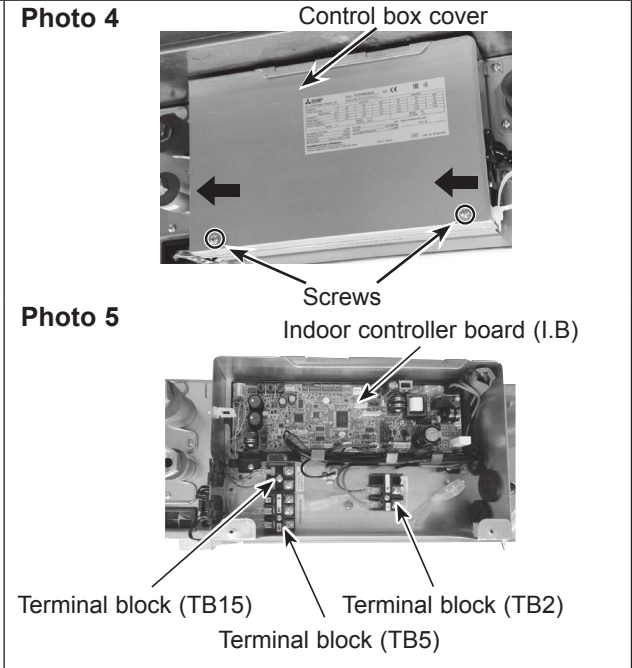

4. Removing the room temperature thermistor (TH21)

(1) Remove the panel. (Refer to procedure 2)

Room temperature thermistor (TH21) (See Photo 6)

(2) Remove the 2 lead wire cover fixing screws. (See Photo 6)

(3) Open the lead wire cover, then remove the connector cover from the connector box.

(4) Remove the band that fixes the room temperature thermistor (TH21) to the connector box.

(5) Remove the room temperature thermistor (TH21) from the connector box.

(6) Remove the connector (CN20) from the indoor controller board, and disconnect the room temperature thermistor (TH21).

Note: When fixing the thermistor, make sure to fix it to the connector box using a band.

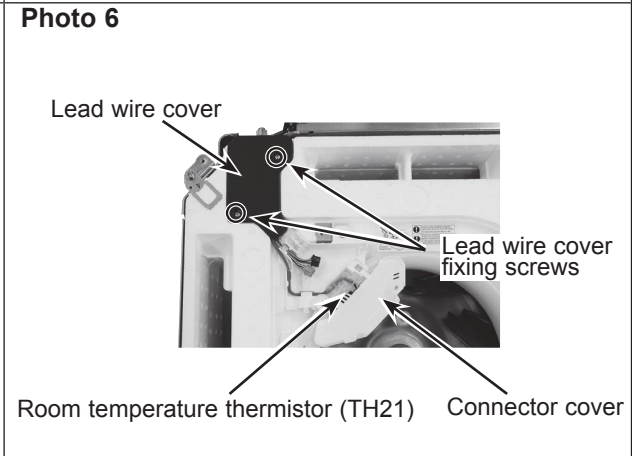

5. Removing the drain pan

(1) Remove the panel. (Refer to procedure 2)

(2) Remove the room temperature thermistor (TH21). (Refer to procedure 4)

Connector box (See Photo 7)

(3) Remove the connector box fixing screw.

(4) Slide the connector box as indicated by the arrow ①, then remove the claw from bell mouth.

Bell mouth (See Photo 7)

(5) Remove the 4 bell mouth fixing screws, then remove the bell mouth.

Drain pan (See Photo 7)

(6) Remove the 4 drain pan fixing screws, then remove the drain pan.

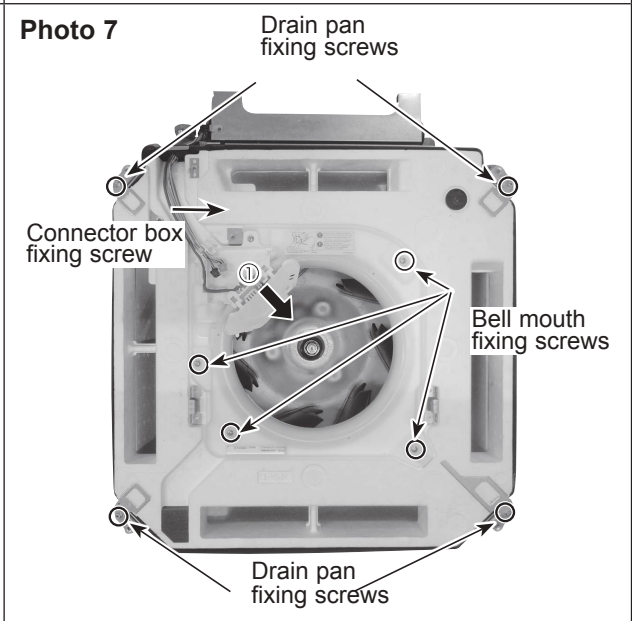



OPERATING PROCEDURE

6. Removing the pipe temperature thermistor/liquid (TH22) and pipe temperature thermistor/gas (TH23)

- (1) Remove the panel. (Refer to procedure 2)
- (2) Remove the room temperature thermistor (TH21). (Refer to procedure 4)
- (3) Remove the drain pan. (Refer to procedure 5)

Pipe temperature thermistor/liquid (TH22) and pipe temperature thermistor/gas (TH23) (See Photo 8-1)

- (4) Remove the control box cover. (Refer to procedure 3)
- (5) Disconnect the thermistor connectors from the CN44 on the indoor controller board.
- (6) Cut the band fixing the thermistor connectors to the fan motor cable.
- (7) Remove the thermistors from the holders on heat exchanger.

Note: When re-attaching the thermistor connectors to the fan motor cable, make sure to put the fixed band into the groove. (See Photo 8-2)

7. Removing the R454B sensor (See Photo 8-1)

- (1) Remove the band
- (2) Remove the screw
- (3) Remove the R454B sensor

Note 1: To install the R454B sensor, orient the sensor case (See Photo 8-3) and insert the tip of sensor case into the sensor guide (See Photo 8-4).

Note 2: When re-attaching the lead wire of the R454B sensor to the fan motor cable with the thermistor connectors, make sure to put the fixed band into the groove. (See Photo 8-2)

Note 3: This refrigerant sensor shall only be replaced with manufacturer approved sensor.

PHOTOS/FIGURES

Photo 8-1

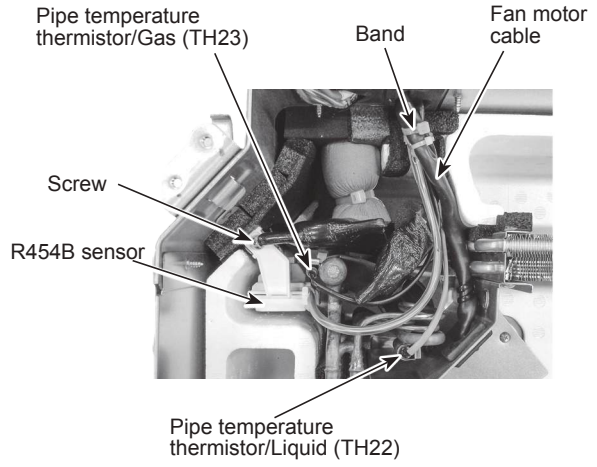

Photo 8-2

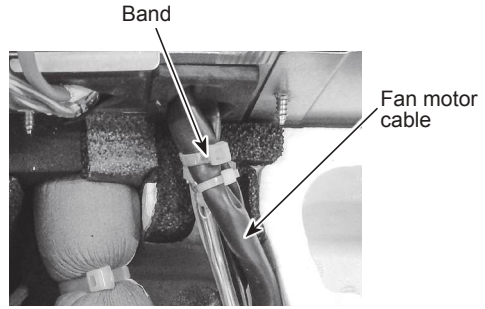

Photo 8-3

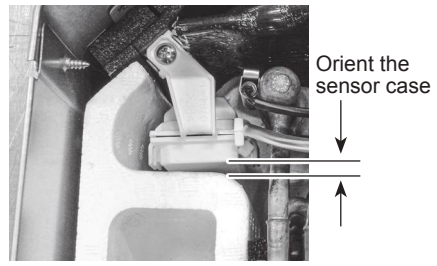
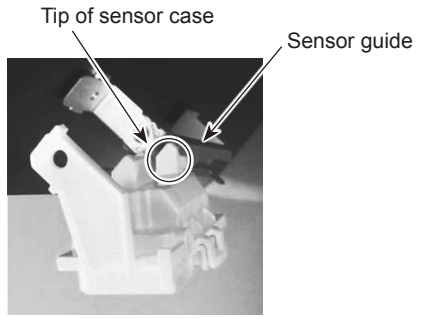

Photo 8-4



OPERATING PROCEDURE

8. Removing the fan motor (MF)

- (1) Remove the panel. (Refer to procedure 2)
- (2) Remove the room temperature thermistor (TH21). (Refer to procedure 4)
- (3) Remove the drain pan. (Refer to procedure 5)

Turbo fan (See Photo 3)

- (4) Remove the nut and washer from the turbo fan.
- (5) Remove the turbo fan from the motor shaft.

< Nut and washer >



Note 1: When assembling the turbo fan, attach it so that its tabs fit the holes of washer.

Note 2: Nut tightening torque: 4.5 ± 0.5 Nm.

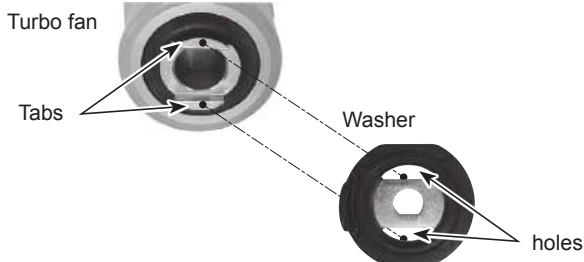

Fan motor (See Photo 9)

- (6) Remove the control box cover. (Refer to procedure 3)
- (7) Disconnect the fan motor cable from the CNMF on the indoor controller board.
- (8) Remove the 2 motor lead cover fixing screws, then remove the motor lead cover.
- (9) Loosen the 3 clamps fixing the fan motor cable.
- (10) Cut the band.
- (11) Remove the 3 nuts and washers, then remove the fan motor.
- (12) Remove the 3 motor mounts.

Note 1: When re-attaching the motor mount, make sure that the thicker end faces the motor shaft. (See Photo 10-1)

Note 2: When re-attaching the turbo fan, make sure that the tightening torque for nuts is 5 N·m or lower.

PHOTOS/FIGURES

Photo 9

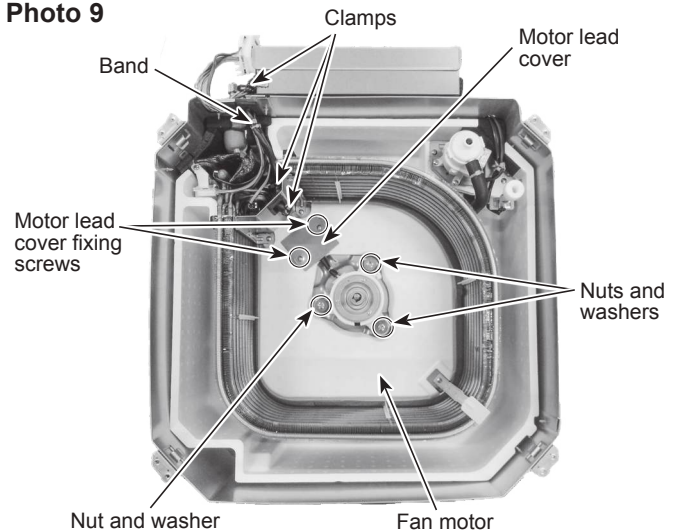
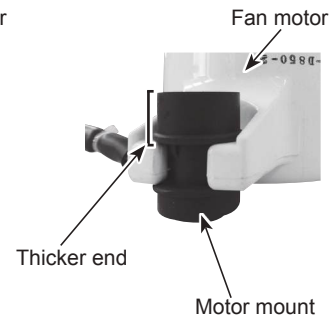

Photo 10



Photo 10-1



OPERATING PROCEDURE

9. Removing the drain pump (DP) and float switch (FS)

- (1) Remove the panel. (Refer to procedure 2)
- (2) Remove the room temperature thermistor (TH21). (Refer to procedure 4)
- (3) Remove the control box cover. (Refer to procedure 3)
- (4) Remove the drain pan. (Refer to procedure 5)

Drain pump (See Photo 11 and 12)

- (5) Disconnect the drain pump connector from the CNP and float switch connector from CN4F on the indoor controller board.
- (6) Loosen the clamp fixing the connectors on the side of the control box.
- (7) Cut the hose band and release the hose.
- (8) Remove the 2 screws fixing the drain pump and float switch to the inner cover.
- (9) Slide the base plate of the drain pump and float switch as indicated by the arrow ① to remove.
- (10) Cut the band. (See Photo 12)
- (11) Remove the 3 drain pump fixing screws, then remove the drain pump. (See Photo 12)

Notes:

1. When re-attaching the drain pump, make sure to use a band to fix the connector to the base plate.
2. Do not give a shock to the float switch. Otherwise it can cause damage or malfunction.

10. Removing the heat exchanger

- (1) Remove the panel. (Refer to procedure 2)
- (2) Remove the room temperature thermistor (TH21). (Refer to procedure 4)
- (3) Remove the drain pan. (Refer to procedure 5)
- (4) Remove the turbo fan and fan motor. (Refer to procedure 8)

Heat exchanger (See Photo 13 and 14)

- (5) Remove the 3 pipe cover fixing screws to remove the pipe cover.
- (6) Remove the 2 coil plate fixing screws.
- (7) Remove the coil support fixing screw, then remove the coil support.
- (8) Remove the heat exchanger.

PHOTOS/FIGURES

Photo 11

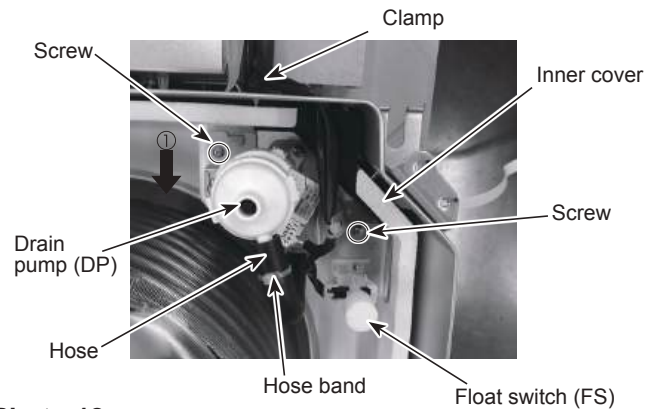

Photo 12

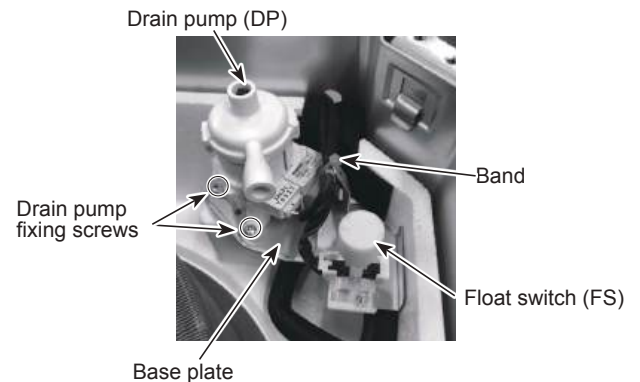

Photo 13

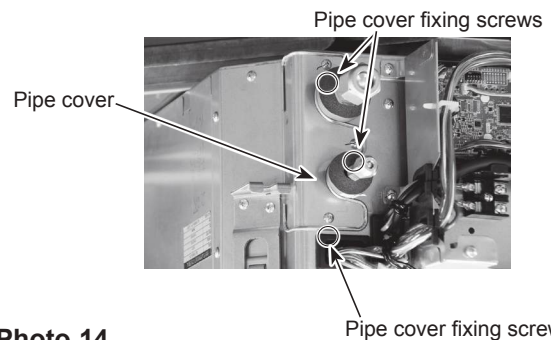
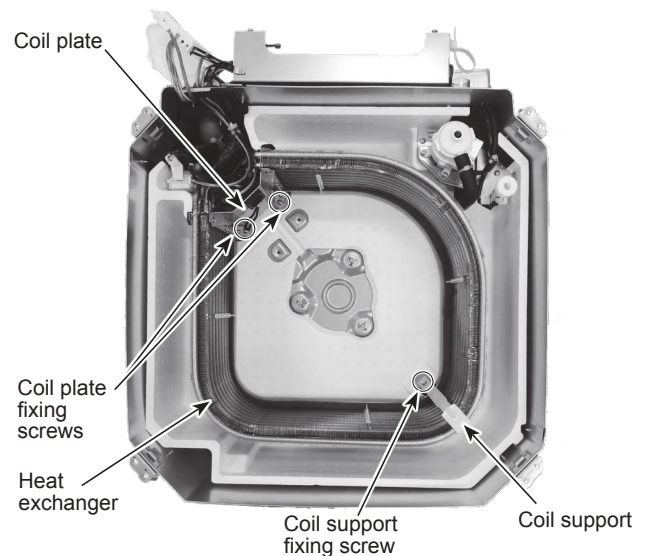

Photo 14



OPERATING PROCEDURE

11. Removing the LEV coil

- (1) Remove the heat exchanger.
- (2) Cut the band.
- (3) Rotate the LEV coil and remove it.

Note:

When reattaching the LEV coil (See Photo 15 and 16)

- (1) Install the LEV coil in the direction shown in Photo 16.
- (2) Bind the lead wire to LEV with the band so that the insulation bends into U shape on the bottom side (as a trap).

PHOTOS/FIGURES

Photo 15

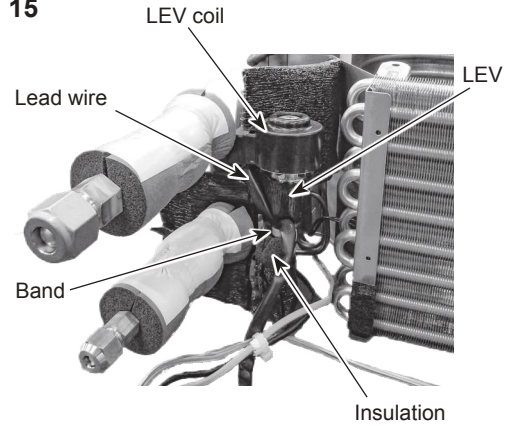
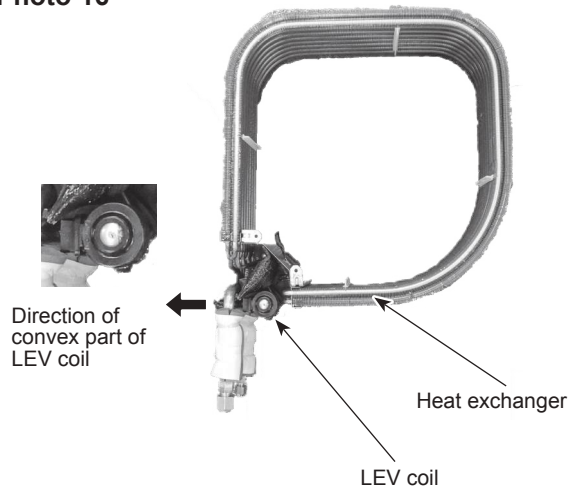

Photo 16



11-1. REMOTE CONTROLLER FUNCTIONS

<PAR-42MAAUB>

Controller interface

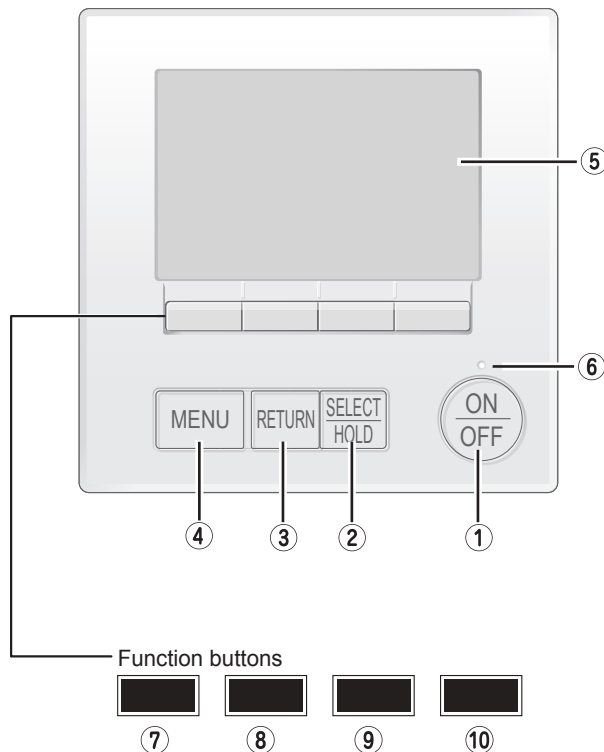

The functions of the function buttons change depending on the screen.

Refer to the button function guide that appears at the bottom of the LCD for the functions they serve on a given screen.

When the system is centrally controlled, the button function guide that corresponds to the locked button will not appear.

Main display

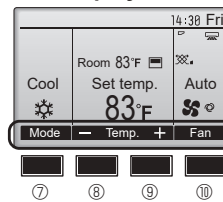

Main menu

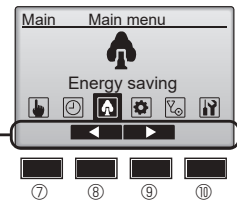

Menu screen

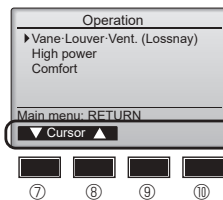

Function guide

① [ON/OFF] button

Press to turn ON/OFF the indoor unit.

② [SELECT/HOLD] button

Press to save the setting.

When the Main menu is displayed, pressing this button will enable/disable the HOLD function.

③ [RETURN] button

Press to return to the previous screen.

④ [MENU] button

Press to bring up the Main menu.

⑤ Backlit LCD

Operation settings will appear.

When the backlight is off, pressing any button turns the backlight on and it will stay lit for a certain period of time depending on the screen.

When the backlight is off, pressing any button turns the backlight on and does not perform its function. (except for the [ON/OFF] button)

⑥ ON/OFF lamp

This lamp lights up in green while the unit is in operation. It blinks while the remote controller is starting up or when there is an error.

⑦ Function button [F1]

Main display: Press to change the operation mode.

Menu screen: The button function varies with the screen.

⑧ Function button [F2]

Main display: Press to decrease temperature.

Main menu: Press to move the cursor left.

Menu screen: The button function varies with the screen.

⑨ Function button [F3]

Main display: Press to increase temperature.

Main menu: Press to move the cursor right.

Menu screen: The button function varies with the screen.

⑩ Function button [F4]

Main display: Press to change the fan speed.

Menu screen: The button function varies with the screen.

Display

The main display can be displayed in two different modes: "Full" and "Basic". The initial setting is "Full". To switch to the "Basic" mode, change the setting on the Main display setting. (Refer to operation manual included with remote controller.)

<Full mode>

All icons are displayed for explanation.

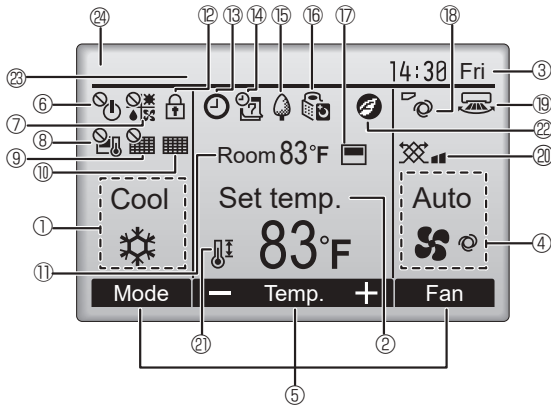

<Basic mode>

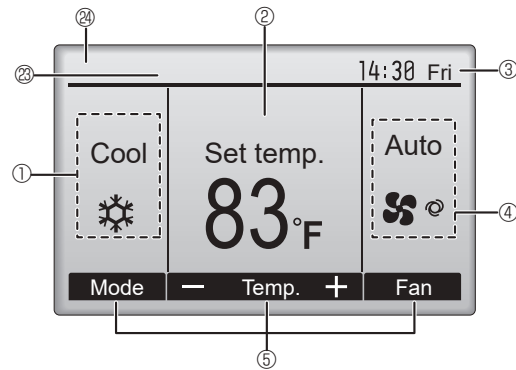

① Operation mode

② Preset temperature

③ Clock

④ Fan speed

⑤ Button function guide

Functions of the corresponding buttons appear here.



Appears when the ON/OFF operation is centrally controlled.



Appears when the operation mode is centrally controlled.



Appears when the preset temperature is centrally controlled.



Appears when the filter reset function is centrally controlled.



Indicates when filter needs maintenance.

⑪ Room temperature



Appears when the buttons are locked.



Appears when the On/Off timer or Auto-off timer function is enabled.

⊘ appears when the timer is disabled by the centralized control system.
⊘ appears when the HOLD function is enable.



Appears when the Weekly timer is enabled.



Appears while the units are operated in the energy saving mode. (Will not appear on some models of indoor units)



Appears while the outdoor units are operated in the silent mode.



Appears when the built-in thermistor on the remote controller is activated to monitor the room temperature (1).

⊘ appears when the thermistor on the indoor unit is activated to monitor the room temperature.



Indicates the vane setting.



Indicates the louver setting.



Indicates the ventilation setting.



Appears when the preset temperature range is restricted.



Appears when an energy saving operation is performed using a "3D i-see Sensor" function.

⑳ Centrally controlled

Appears for a certain period of time when a centrally-controlled item is operated.

㉑ Preliminary error display

A check code appears during the preliminary error.

Most settings (except ON/OFF, mode, fan speed, temperature) can be made from the Main menu.

Menu structure

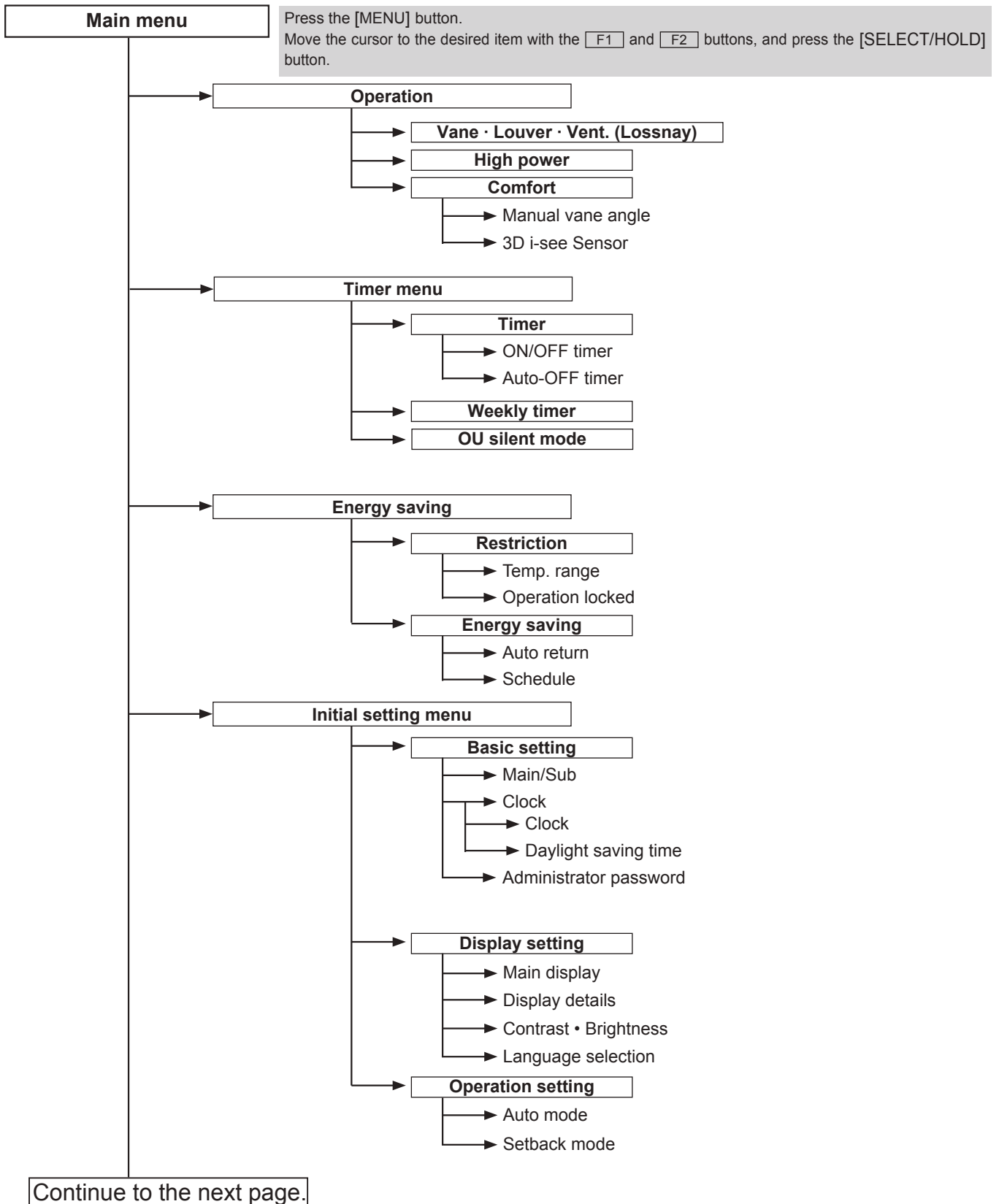

Not all functions are available on all models of indoor units.

Continue from the previous page.

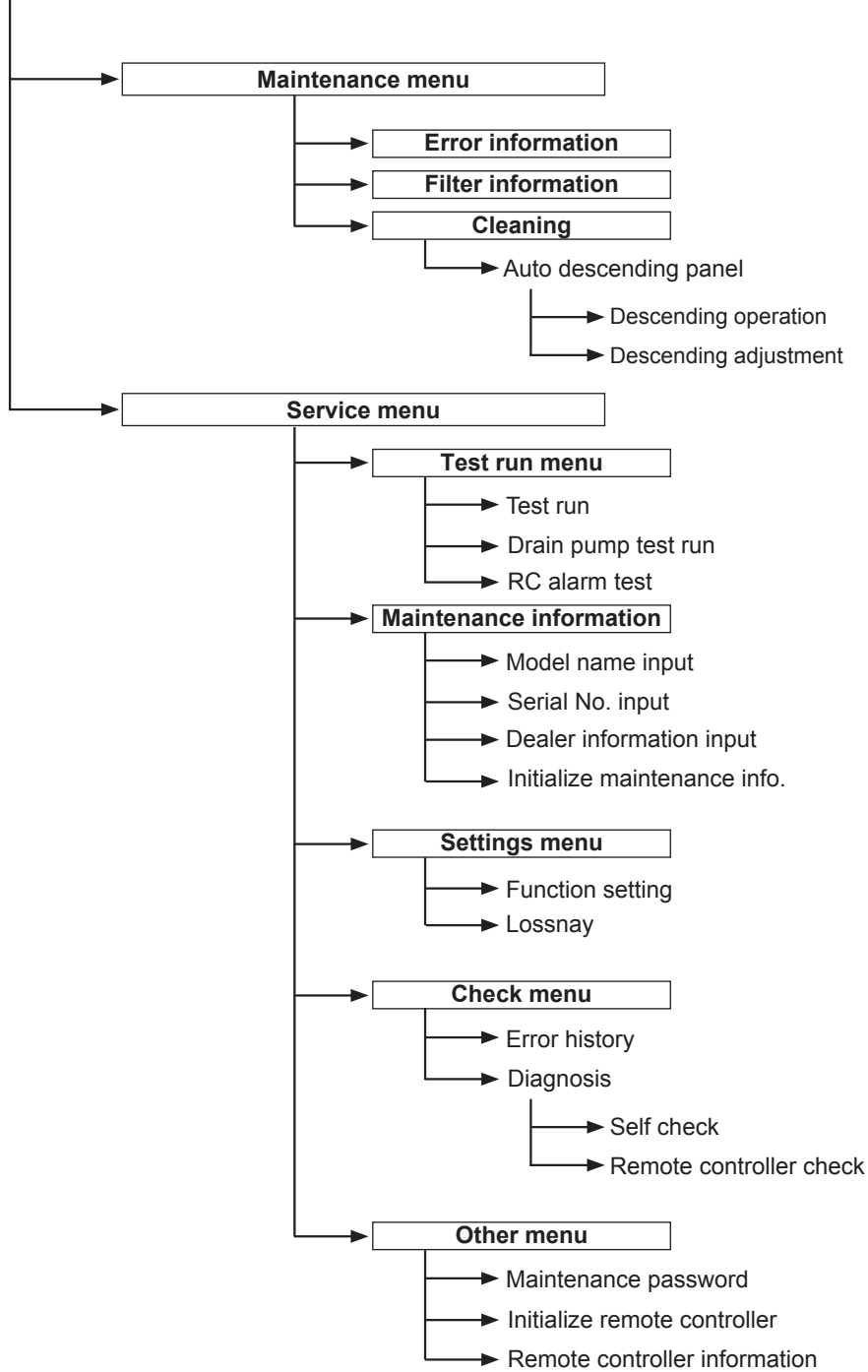

Not all functions are available on all models of indoor units.

Main menu list

Main menu	Setting and display items		Setting details
Operation	Vane · Louver · Vent. (Lossnay)		<p>Use to set the vane angle.</p> <ul style="list-style-type: none"> • Select a desired vane setting from 5 different settings. <p>Use to turn ON/OFF the louver.</p> <ul style="list-style-type: none"> • Select a desired setting from "ON" and "OFF." <p>Use to set the amount of ventilation.</p> <ul style="list-style-type: none"> • Select a desired setting from "Off," "Low," and "High."
	High power ^{*3}		<p>Use to reach the comfortable room temperature quickly.</p> <ul style="list-style-type: none"> • Units can be operated in the High-power mode for up to 30 minutes.
	Comfort	Manual vane angle	Use to fix each vane angle.
		3D i-see Sensor	<p>Use to set the following functions for 3D i-see Sensor.</p> <ul style="list-style-type: none"> • Air distribution • Energy saving option • Seasonal airflow
Timer	Timer	ON/OFF timer ^{*1}	<p>Use to set the operation ON/OFF times.</p> <ul style="list-style-type: none"> • Time can be set in 5-minute increments.
		Auto-OFF timer	<p>Use to set the Auto-OFF time.</p> <ul style="list-style-type: none"> • Time can be set to a value from 30 to 240 in 10-minute increments.
	Weekly timer ^{*1, *2}		<p>Use to set the weekly operation ON/OFF times.</p> <ul style="list-style-type: none"> • Up to 8 operation patterns can be set for each day. (Not valid when the ON/OFF timer is enabled.)
	OU silent mode ^{*1, *3}		<p>Use to set the time periods in which priority is given to quiet operation of outdoor units over temperature control. Set the Start/Stop times for each day of the week.</p> <ul style="list-style-type: none"> • Select the desired silent level from "Normal," "Middle," and "Quiet."
Energy saving	Restriction	Temp. range ^{*2}	<p>Use to restrict the preset temperature range.</p> <ul style="list-style-type: none"> • Different temperature ranges can be set for different operation modes.
		Operation lock	<p>Use to lock selected functions.</p> <ul style="list-style-type: none"> • The locked functions cannot be operated.
	Energy saving	Auto return ^{*2}	<p>Use to get the units to operate at the preset temperature after performing energy saving operation for a specified time period.</p> <ul style="list-style-type: none"> • Time can be set to a value from 30 and 120 in 10-minute increments. (This function will not be valid when the preset temperature ranges are restricted.)
		Schedule ^{*1}	<p>Set the start/stop times to operate the units in the energy saving mode for each day of the week, and set the energy saving rate.</p> <ul style="list-style-type: none"> • Up to 4 energy saving operation patterns can be set for each day. • Time can be set in 5-minute increments. • Energy saving rate can be set to a value from 0% or 50 to 90% in 10% increments.

*1 Clock setting is required.

*2 1°F increments.

*3 This function can only be set when certain outdoor units are connected.

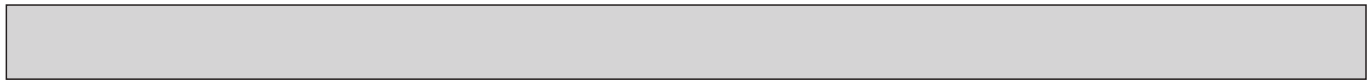

Main menu	Setting and display items		Setting details
Initial setting	Basic setting	Main/Sub	When connecting 2 remote controllers, one of them needs to be designated as a sub controller.
		Clock	Use to set the current time.
		Daylight saving time	Set the daylight saving time.
		Administrator password	The administrator password is required to make the settings for the following items. • Timer setting • Energy saving setting • Weekly timer setting • Restriction setting • Outdoor unit silent mode setting • Night set back
	Display setting	Main display	Use to switch between "Full" and "Basic" modes for the Main display, and use to change the background colors of the display to black.
		Display details	Make the settings for the remote controller related items as necessary. Clock: The initial settings are "Yes" and "24h" format. Temperature: Set either Celsius (°C) or Fahrenheit (°F). Room temp. : Set Show or Hide. Auto mode: Set Auto mode display or Only Auto display.
		Contrast • Brightness	Use to adjust screen contrast and brightness.
		Language selection	Use to select the desired language.
	Operation setting	Auto mode	Whether or not to use Auto mode can be selected by using the button. This setting is valid only when indoor units with Auto mode function are connected.
Setback mode		Whether or not to use the Setback mode can be selected by using the button. This setting is valid only when indoor units with the Setback mode function are connected.	
Maintenance	Error information		Use to check error information when an error occurs. • Check code, error source, refrigerant address, model name, manufacturing number, contact information (dealer's phone number) can be displayed. (The model name, manufacturing number, and contact information need to be registered in advance to be displayed.)
	Filter information		Use to check the filter status. • The filter sign can be reset.
	Cleaning	Auto descending panel	Use to lift and lower the auto descending panel (Optional parts).
Service	Test run		Select "Test run" from the Service menu to bring up the Test run menu. • Test run • Drain pump test run • RC alarm test
	Input maintenance info.		Select "Input maintenance Info." from the Service menu to bring up the Maintenance information screen. The following settings can be made from the Maintenance Information screen. • Model name input • Serial No. input • Dealer information input • Initialize maintenance info.
	Settings	Function setting	Make the settings for the indoor unit functions via the remote controller as necessary.
		LOSSNAY setting	This setting is required only when the operation of CITY MULTI units is interlocked with LOSSNAY units.
	Check	Error history	Display the error history and execute "delete error history".
		Diagnosis	Self check: Error history of each unit can be checked via the remote controller. Remote controller check: When the remote controller does not work properly, use the remote controller checking function to troubleshoot the problem.
	Others	Maintenance password	Use to change the maintenance password.
		Initialize remote controller	Use to initialize the remote controller to the factory shipment status.
		Remote controller information	Use to display the remote controller model name, software version, and serial number.

<PAC-YT53CRAU>

Note:

The phrase "Wired remote controller" in this manual refers only to the PAC-YT53CRAU.

If you need any information for the other remote controller, please refer to either the installation manual or initial setting manual which are included in remote controller's box.

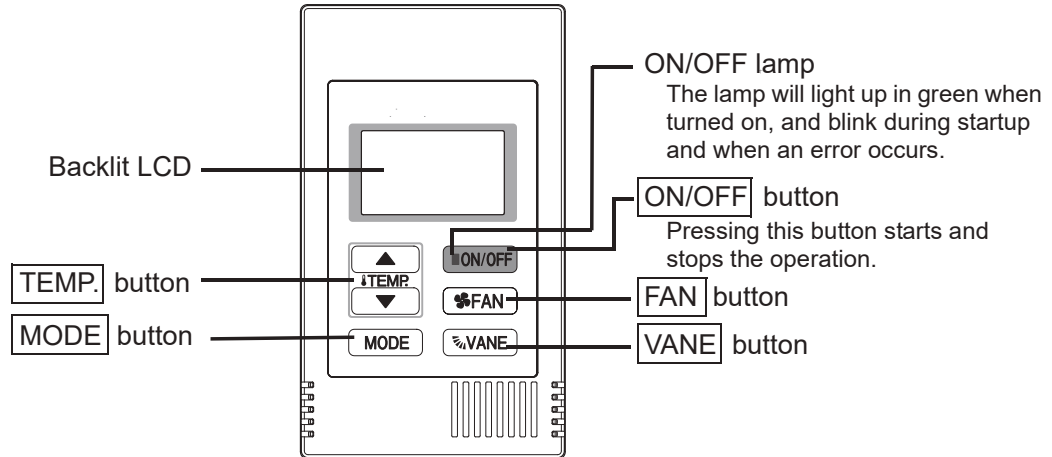

Note: To set the functions that are not available on this controller (TAC-YT53CRAU) such as Louver, use the centralized controller.

Display section

Note: All icons are displayed for explanation purpose.

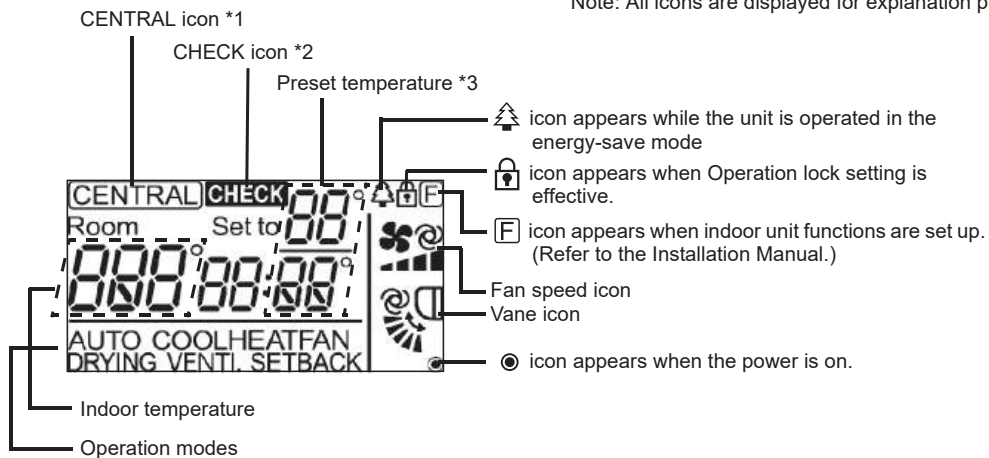

*1 **CENTRAL** icon

Appears when one of the following local operations is prohibited: ON/OFF; operation mode; preset temperature; fan speed; vane.

*2 **CHECK** icon

For City Multi, when an error occurs, power indicator will blink, and unit address (3 digits) and check code (4 digits) will blink.

Check the error status, stop the operation, and consult your dealer.

*3 Preset temperature

* Centigrade or Fahrenheit is selectable. Refer to the Installation Manual for details.

In COOL, DRYING, HEAT, or AUTO (single set point) modes

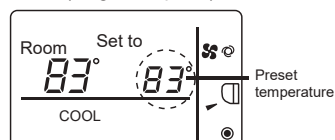

In AUTO (dual set point) or SETBACK modes

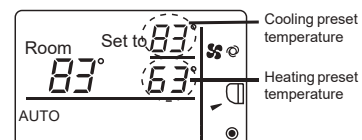

<PAR-SL101A-E>

Controller interface

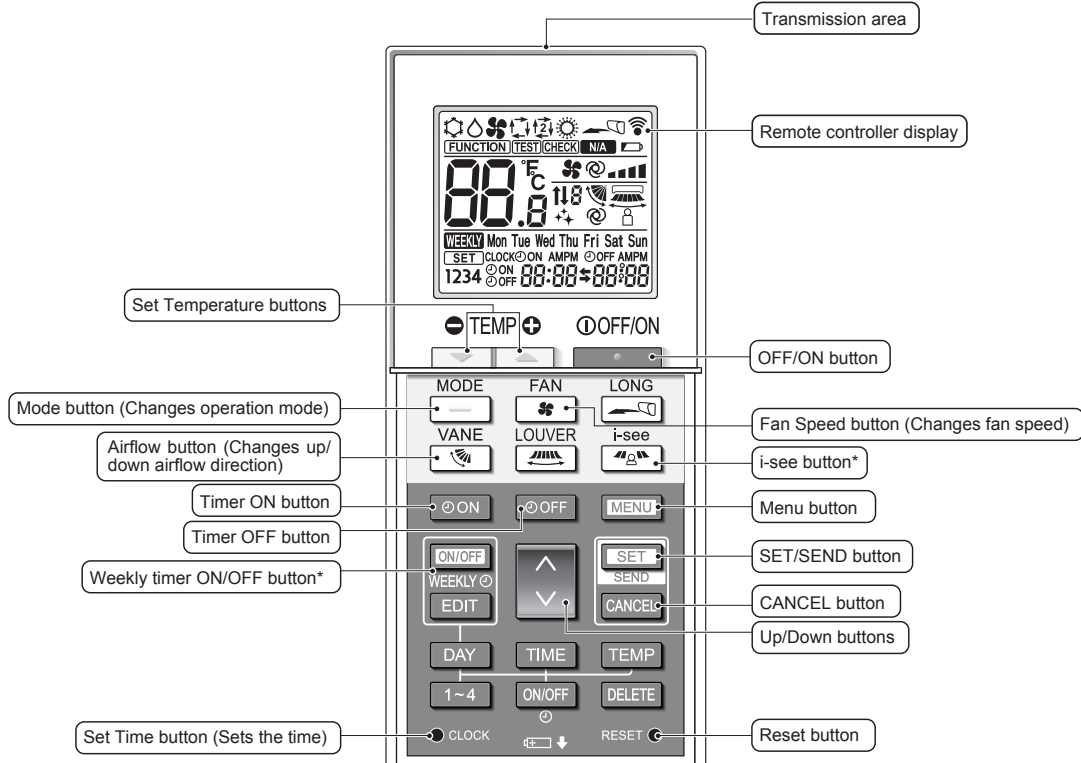

Note:

* This button is enabled or disabled depending on the model of the indoor unit.

Display

Operation mode

- Cool (snowflake icon)
- Dry (water drop icon)
- Fan (fan icon)
- Auto (single set point) (circular arrow icon)
- Heat (sun icon)
- Auto (dual set point) (circular arrow with two dots icon)

Temperature setting
The units of temperature can be changed. For details, refer to the Installation Manual.

Vane setting

Step 1 Step 2 Step 3 Step 4 Step 5 Swing Auto

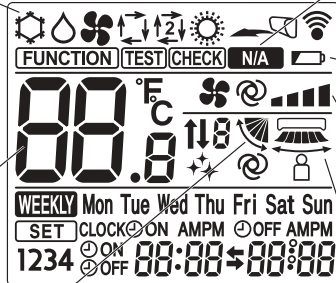

Not available
Appears when a non-supported function is selected.

Battery replacement indicator
Appears when the remaining battery power is low.

Fan speed setting

Auto

3D i-see Sensor (Air distribution)

Default Direct Indirect

When Direct or Indirect is selected, the vane setting is set to "Auto".

11-2. ERROR INFORMATION

**When an error occurs, the following screen will appear.
Check the error status, stop the operation, and consult your dealer.**

1. Check code, error unit, refrigerant address, model name, and serial number will appear.
The model name and serial number will appear only if the information has been registered.

Press the **[F1]** or **[F2]** button to go to the next page.

Error information		1/2
Error code	2502	
Error unit	IU	Unit#1
Time Occurred	02/01	4:48
Model name		
Serial No.		
Reset error: Reset button		
▼ Page ▲	Reset	

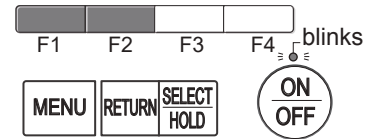

Contact information (dealer's phone number) will appear if the information has been registered.

Error information		2/2
Contact information		
Dealer		
Tel		
Reset error: Reset button		
▼ Page ▲	Reset	

2. Press the **[F4]** button or the **[ON/OFF]** button to reset the error that is occurring.

Errors cannot be reset while the ON/OFF operation is prohibited.

Error information		1/2
Error code	2502	
Error unit	IU	Unit#1
Time Occurred	02/01	4:48
Model name		
Serial No.		
Reset error: Reset button		
▼ Page ▲	Reset	

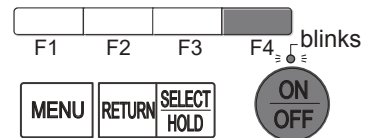

Select "OK" with the **[F4]** button.

Error reset	
Reset current error?	
Cancel	OK

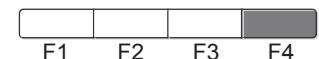

Error reset	
Error reset	
Main menu: MENU	

Navigating through the screens

- To go back to the Service menu **[MENU]** button

• Checking the error information

While no errors are occurring, page 2/2 of the error information can be viewed by selecting "Error information" from the Maintenance menu. Errors cannot be reset from this screen.

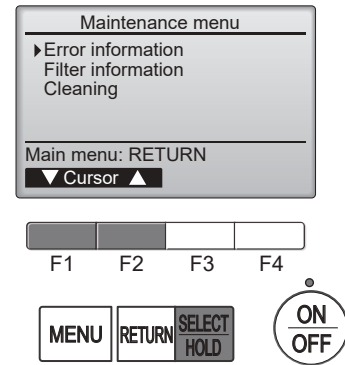

11-3. SERVICE MENU

Maintenance password is required

1. Select "Service" from the Main menu, and press the [SELECT/HOLD] button.

*At the main display, the menu button and select "Service" to make the maintenance setting.

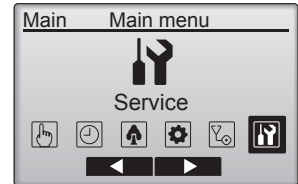

2. When the Service menu is selected, a window will appear asking for the password.

To enter the current maintenance password (4 numerical digits), move the cursor to the digit you want to change with the [F1] or [F2] button.



Set each number (0 through 9) with the [F3] or [F4] button.



Then, press the [SELECT/HOLD] button.

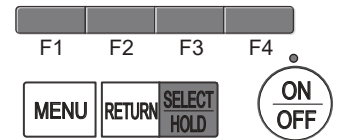
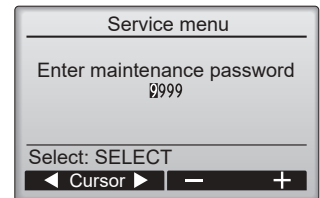

Note: The initial maintenance password is "9999". Change the default password as necessary to prevent unauthorized access. Have the password available for those who need it.

: If you forget your maintenance password, you can initialize the password to the default password "9999" by pressing and holding the [F1] button for 10 seconds on the maintenance password setting screen.

3. If the password matches, the Service menu will appear.

The type of menu that appears depends on the connected indoor units' type.

Note: Air conditioning units may need to be stopped to make only at "Settings". There may be some settings that cannot be made when the system is centrally controlled.



A screen will appear that indicates the setting has been saved.

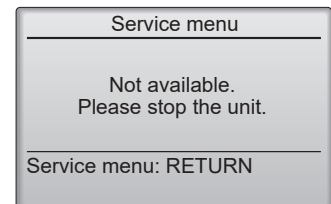
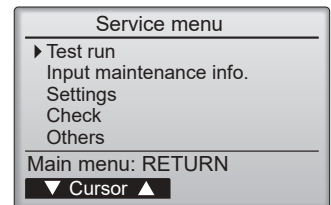

Navigating through the screens

- To go back to the Service menu [MENU] button
- To return to the previous screen..... [RETURN] button

11-4. TEST RUN

11-4-1. PAR-42MAAUB

1. Select "Service" from the Main menu, and press the [SELECT/HOLD] button.

Select "Test run" with the [F1] or [F2] button, and press the [SELECT/HOLD] button.

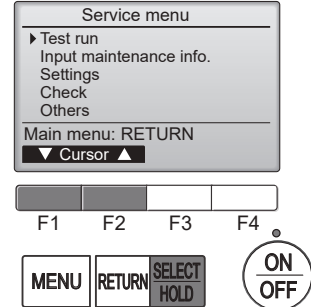

2. Select "Test run" with the [F1] or [F2] button, and press the [SELECT/HOLD] button.

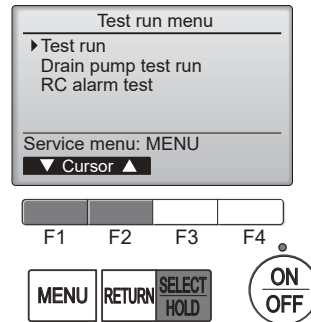

Test run operation

Press the [F1] button to go through the operation modes in the order of "Cool and Heat".

Cool mode: Check the cold air blows out.
Heat mode: Check the heat blows out.

Check the operation of the outdoor unit's fan.

Press the [SELECT/HOLD] button and open the Vane setting screen.

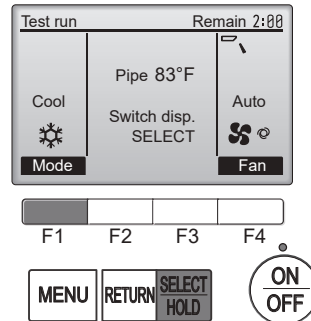

Auto vane check

Check the auto vane with the [F1] [F2] buttons.

Press the [RETURN] button to return to "Test run operation".







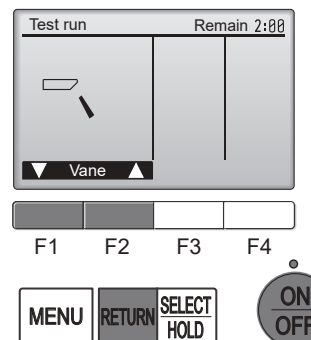



Press the [ON/OFF] button.

When the test run is completed, the "Test run menu" screen will appear. The test run will automatically stop after 2 hours.

*The function is available only for the model with vanes.



11-4-2. PAR-SL101A-E

1. Press the  button ① to stop the air conditioner.
 - If the weekly timer is enabled (**WEEKLY** is on), press the  button ③ to disable it (**WEEKLY** is off).
2. Press the  button ② for 5 seconds.
 - **CHECK** comes on and the unit enters the service mode.
3. Press the  button ②.
 - **TEST**  comes on and the unit enters the test run mode.
4. Press the following buttons to start the test run.
 - : Switch the operation mode between cooling and heating and start the test run.
 - : Switch the fan speed and start the test run.
 - : Switch the airflow direction and start the test run.
 - : Switch the louver and start the test run.
 - : Start the test run.
5. Stop the test run.
 - Press the  button ① to stop the test run.
 - After 2 hours, the stop signal is transmitted.

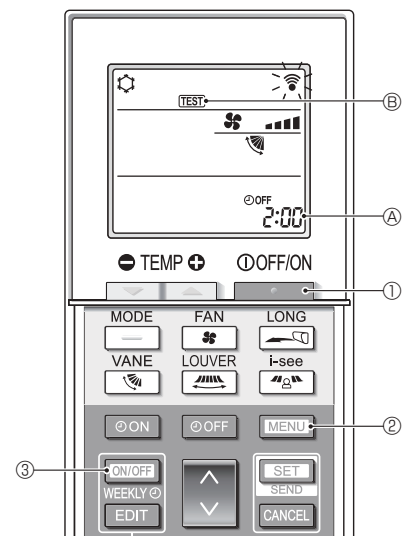

11-5. FUNCTION SETTING

11-5-1. PAR-42MAAUB

1. Select "Service" from the Main menu, and press the [SELECT/HOLD] button.

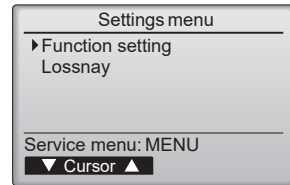

Select "Setting" from the Service menu, and press the [SELECT/HOLD] button.

Select "Function setting", and press the [SELECT/HOLD] button.

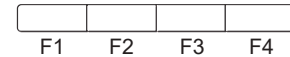

2. The Function setting screen will appear.

Press the [F1] or [F2] button to move the cursor to one of the following: M-NET address, function setting number, or setting value. Then, press the [F3] or [F4] button to change the settings to the desired settings.

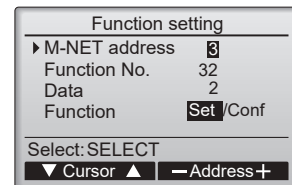

Once the settings have been completed, press the [SELECT/HOLD] button.

A screen will appear indicating that the settings information is being sent. To check the current settings of a given unit, enter the setting for its M-NET address and function setting number, select Conf for the Function, and press the [SELECT/HOLD] button.

A screen will appear indicating that the settings are being searched for. When the search is done, the current settings will appear.

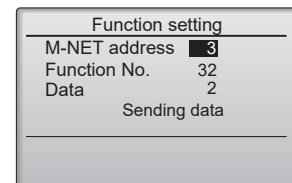

When the settings information has been sent, a screen will appear indicating its completion.

To make additional settings, press the [RETURN] button to return to the screen shown in the above step. Set the function numbers for other indoor units by following the same steps.

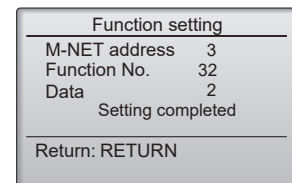

Note:

- Refer to the indoor unit Installation Manual for information about the factory settings of indoor units, function setting numbers, and setting values.
- Be sure to write down the settings for all functions if any of the initial settings has been changed after the completion of installation work.

11-6. ERROR HISTORY

1. Select "Service" from the Main menu, and press the [SELECT/HOLD] button.



Select "Check" with the [F1] or [F2] button, and press the [SELECT/HOLD] button.

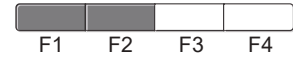
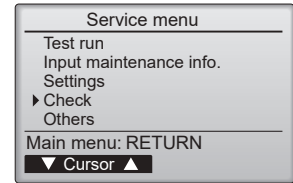

2. Select "Error history" with the [F1] or [F2] button, and press the [SELECT/HOLD] button.

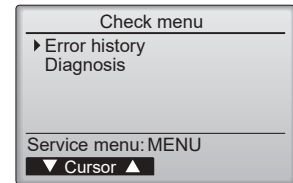

3. 16 error history records will appear.

4 records are shown per page, and the top record on the first page indicates the latest error record.

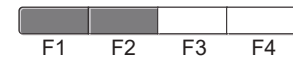
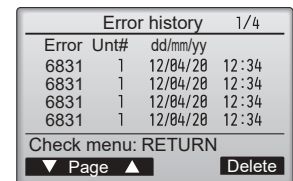

4. Deleting the error history

To delete the error history, press the [F4] button (Delete) on the screen that shows error history.

A confirmation screen will appear asking if you want to delete the error history.



Press the [F4] button (OK) to delete the history.



"Error history deleted" will appear on the screen.

Press the [RETURN] button to go back to the Check menu screen.

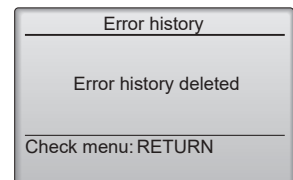
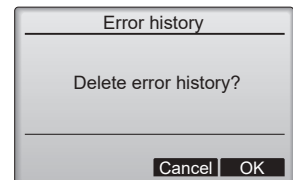

11-7. SELF-DIAGNOSIS

11-7-1. PAR-42MAAUB

1. Select "Service" from the Main menu, and press the [SELECT/HOLD] button.

Select "Check" from the Service menu, and press the [SELECT/HOLD] button.

Select "Diagnosis" from the Check menu, and press the [SELECT/HOLD] button.

Select "Self check" with the [F1] or [F2] button, and press the [SELECT/HOLD] button.

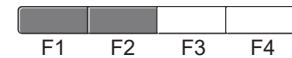
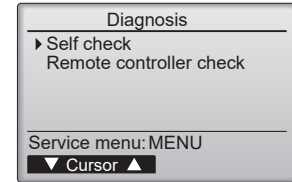

2. Select "Self check" from the Diagnosis menu, and press the [SELECT/HOLD] button to view the Self check screen.

With the [F1] or [F2] button, enter the M-NET address, and press the [SELECT/HOLD] button.

Check code, unit number, attribute, and indoor unit demand signal ON/OFF status at the contact will appear. "-" will appear if no error history is available.

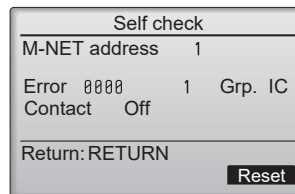
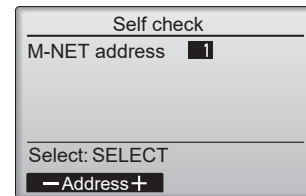

When there is no error history

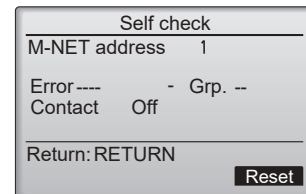

3. Resetting the error history

Press the [F4] button (Reset) on the screen that shows the error history. A confirmation screen will appear asking if you want to delete the error history.

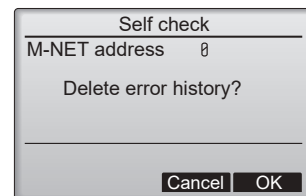

Press the [F4] button (OK) to delete the error history. If deletion fails, "Request rejected" will appear, and "Unit not exist" will appear if indoor units that correspond to the entered address are not found.

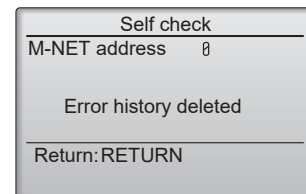

11-7-2. PAR-SL101A-E

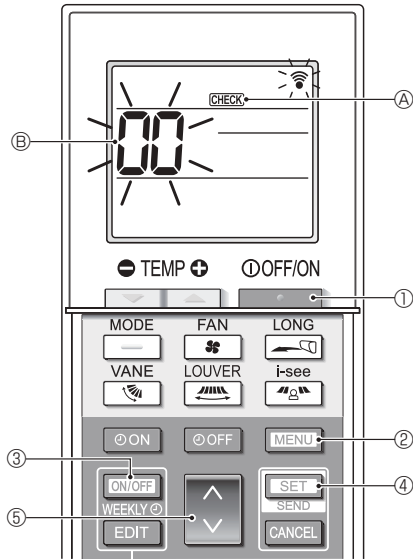

1. Press the **OFF/ON** button ① to stop the air conditioner.
 - If the weekly timer is enabled (**WEEKLY** is on), press the **ON/OFF WEEKLY** button ③ to disable it (**WEEKLY** is off).
2. Press the **MENU** button ② for 5 seconds.
 - **CHECK** ① comes on and the unit enters the self-check mode.
3. Press the **DOWN** button ⑤ to select the refrigerant address (M-NET address) ⑥ of the indoor unit for which you want to perform the self-check.
4. Press the **SET** button ④.
 - If an error is detected, the check code is indicated by the number of beeps from the indoor unit and the number of blinks of the OPERATION INDICATOR lamp.
5. Press the **OFF/ON** button ①.
 - **CHECK** ① and the refrigerant address (M-NET address) ⑥ go off and the self-check is completed.

11-8. REFRIGERANT SENSOR UNNECESSARY SETTING

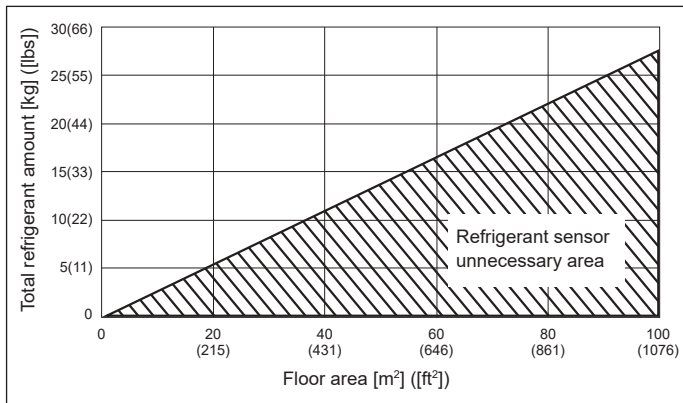

If $M/A \leq 0.27$, the refrigerant sensor can be disabled by disconnecting the CNSB connector on the control board.

M: Total refrigerant amount [kg] ([lbs])

A: Floor area [m²] ([ft²])

Caution: Do not disconnect the CNSB connector in an environment where $M/A \geq 0.27$.

If a refrigerant leak occurs with the refrigerant sensor disabled, the safety device will not be able to operate.

11-9. REMOTE CONTROLLER CHECK

If operations cannot be completed with the remote controller, diagnose the remote controller with this function.

1. Select "Service" from the Main menu, and press the [SELECT/HOLD] button.

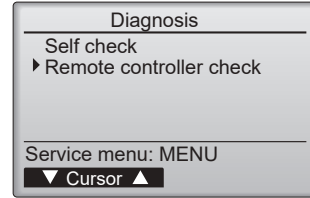

Select "Check" from the Service menu, and press the [SELECT/HOLD] button.

Select "Diagnosis" from the Check menu, and press the [SELECT/HOLD] button.

Select "Remote controller check" with the [F1] or [F2] button, and press the [SELECT/HOLD] button.

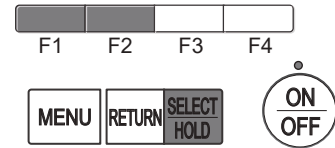

2. Select "Remote controller check" from the Diagnosis menu, and press the [SELECT/HOLD] button to start the remote controller check and see the check results.

To cancel the remote controller check and exit the "Remote controller check" menu screen, press the [MENU] or the [RETURN] button.

The remote controller will not reboot itself.

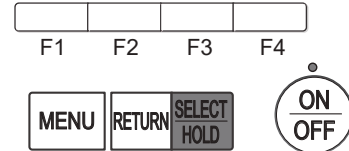
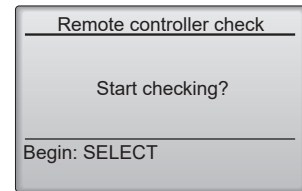

3.
 - OK: No problems are found with the remote controller. Check other parts for problems.
 - E3, 6832: There is noise on the transmission line, or the indoor unit or another remote controller is faulty. Check the transmission line and the other remote controllers.
 - NG (ALL0, ALL1): Send-receive circuit fault. The remote controller needs replacing.
 - ERC: The number of data errors is the discrepancy between the number of bits in the data transmitted from the remote controller and that of the data that was actually transmitted over the transmission line. If data errors are found, check the transmission line for external noise interference.

Remote controller check results screen

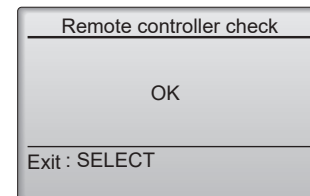

If the [SELECT/HOLD] button is pressed after the remote controller check results are displayed, remote controller check will end, and the remote controller will automatically reboot itself.

Check the remote controller display and see if anything is displayed (including lines). Nothing will appear on the remote controller display if the correct voltage (8.5–12 VDC) is not supplied to the remote controller. If this is the case, check the remote controller wiring and indoor units.

CITY MULTI

MITSUBISHI ELECTRIC CORPORATION

HEAD OFFICE : TOKYO BUILDING, 2-7-3, MARUNOUCHI, CHIYODA-KU TOKYO 100-8310, JAPAN
