



SiUS122410EB

R-32

Service Manual

Multi-Split Type Air Conditioners MXM-A, MXT-A, MXTH-A Series

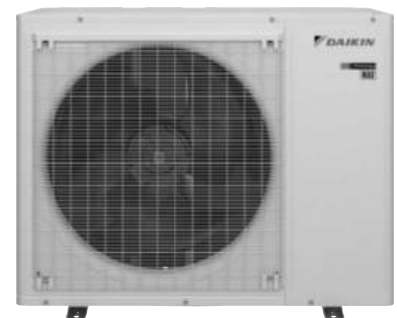

[Applied Models]

● Inverter Multi : Heat Pump

Introduction	1
1. Safety Cautions.....	2
1.1 Warnings and Cautions Regarding Safety of Workers.....	2
1.2 Warnings and Cautions Regarding Safety of Users.....	7
2. Icons Used	10
3. Revision History	11
Part 1 General Information	12
1. Applicable Models	13
2. Functions.....	14
2.1 Indoor Unit.....	14
2.2 Outdoor Unit.....	16
Part 2 Specifications.....	17
1. Specifications	18
1.1 Indoor Unit.....	18
1.2 Outdoor Unit.....	25
Part 3 Printed Circuit Board Connector Wiring Diagram.....	31
1. Indoor Unit.....	32
1.1 CTXV07AVJU9, FTXV09/12/15/18/24AVJU9	32
1.2 CDMA07AVJU9, FDMA09/12/15/18/24AVJU9	34
1.3 FVXV09/12/15/18AVJUW(T)9.....	36
1.4 CMXV12/18/24AVJUA	40
2. Outdoor Unit.....	41
2.1 2/3/4MXM, 2MXT	41
2.2 5MXM, 3/4/5MXT, 3/4/5MXTH	44
Part 4 Functions and Control	46
1. Main Functions.....	48
1.1 Temperature Control	48
1.2 Frequency Principle.....	48
2. Functions for Wall Mounted Type	50
2.1 Airflow Direction Control.....	50
2.2 COMFORT AIRFLOW Operation	51
2.3 Fan Speed Control for Indoor Unit	52
2.4 Program Dry Operation	53
2.5 Automatic Cooling/Heating Change-over	54
2.6 Thermostat Control.....	55
2.7 NIGHT SET Mode	56
2.8 ECONO Operation	56
2.9 POWERFUL Operation	57
2.10 Brightness Setting of Indoor Unit Display	58
2.11 Wireless LAN Connection	59
2.12 Other Functions.....	63
3. Functions for Duct Concealed Type.....	64
3.1 Fan Speed Control for Indoor Unit	64
3.2 Program Dry Operation	64

3.3	Automatic Cooling/Heating Change-over	65
3.4	Clock and Calendar Setting (With BRC1NRV71).....	66
3.5	Schedule Timer Operation (With BRC1NRV71).....	68
3.6	Drain Pump Control.....	72
3.7	Hot Start Control (In Heating Operation Only).....	74
3.8	Other Functions.....	75
4.	Functions for Floor Standing Type	76
4.1	Airflow Direction Control.....	76
4.2	FLOOR WARMING Operation	78
4.3	Fan Speed Control for Indoor Unit	79
4.4	Program Dry Operation	80
4.5	Automatic Cooling/Heating Change-over	81
4.6	Thermostat Control.....	82
4.7	NIGHT SET Mode	83
4.8	ECONO Operation	83
4.9	HOME LEAVE Operation	84
4.10	POWERFUL Operation	85
4.11	HEAT PLUS Operation.....	86
4.12	Operation lamp (Multi-color).....	87
4.13	Clock Setting	88
4.14	WEEKLY TIMER Operation	89
4.15	Brightness Setting of Indoor Unit Display	95
4.16	CLEAN Operation.....	96
4.17	Wireless LAN Connection	98
4.18	Other Functions.....	101
5.	Functions for CMXV Series.....	102
5.1	Fan Speed Control for Indoor Unit	102
5.2	Program Dry Operation	102
5.3	Automatic Cooling/Heating Change-over	102
5.4	Refrigerant Detection System (RDS) Function.....	103
5.5	Leak Detection Output (Relay K6R).....	104
5.6	Accessory Contacts (Humidifier Relay).....	105
5.7	Electric Heater Control	106
5.8	Fan Off-delay Control	107
5.9	Auxiliary Alarm Switch.....	107
5.10	Freeze-up Protection Control	108
6.	Control Specification	109
6.1	Thermistor Functions.....	109
6.2	Mode Hierarchy	111
6.3	Compressor Speed Control.....	112
6.4	Controls at Mode Changing/Start-up.....	114
6.5	Discharge Pipe Temperature Control.....	116
6.6	Input Current Control.....	117
6.7	Freeze-up Protection Control	118
6.8	Heating Peak-cut Control	119
6.9	High Pressure Protection Control.....	120
6.10	Outdoor Fan Control.....	121
6.11	Liquid Compression Protection Function.....	121
6.12	Defrost Control	121
6.13	Low Compressor Speed High Pressure Limit	128
6.14	Electronic Expansion Valve Control	129
6.15	Malfunctions	134

Part 5 Remote Controller	135
1. Applicable Remote Controller and Thermostat	136
2. BRC1NRV71	137
3. ARC466A89	143
4. ARC480A83	145
5. BRC073A6	147
6. BRC944B2	151
7. Daikin One Thermostat	152
Part 6 Service Diagnosis	153
1. General Problem Symptoms and Check Items	156
2. Troubleshooting with LED	157
2.1 Indoor Unit.....	157
2.2 Outdoor Unit.....	158
3. Service Diagnosis	159
3.1 BRC1NRV71	159
3.2 ARC466 Series.....	161
3.3 ARC480 Series.....	164
3.4 BRC073A6	167
4. Code Indication on Remote Controller	169
4.1 Indoor Unit.....	169
4.2 Outdoor Unit.....	170
5. Troubleshooting for Wall Mounted Type	171
5.1 Indoor Unit PCB Abnormality	171
5.2 Freeze-up Protection Control/Heating Peak-cut Control	172
5.3 Indoor Fan Motor (DC Motor) or Related Abnormality	173
5.4 Indoor Heat Exchanger Thermistor or Related Abnormality.....	175
5.5 Room Temperature Sensor Abnormality/Humidity Sensor Abnormality	176
5.6 Signal Transmission Error (Between Indoor Unit and Outdoor Unit).....	177
5.7 Unspecified Voltage (Between Indoor Unit and Outdoor Unit).....	179
6. Troubleshooting for Duct Concealed Type.....	180
6.1 External Protection Device Abnormality	180
6.2 Refrigerant Leak Detection (Confirmed).....	181
6.3 Refrigerant Leak Detection (Monitoring)	183
6.4 Indoor Unit PCB Abnormality	184
6.5 Drain Level Control System Abnormality.....	185
6.6 Indoor Fan Motor (DC Motor) or Related Abnormality	186
6.7 Indoor Fan PCB Abnormality.....	188
6.8 Humidifier or Related Abnormality.....	189
6.9 Defective Capacity Setting	190
6.10 Transmission Abnormality between Indoor Unit Control PCB and Fan PCB.....	191
6.11 Thermistor or Related Abnormality.....	193
6.12 Refrigerant Leak Detection Sensor Failure	194
6.13 Refrigerant Leak Detection Sensor Disconnection.....	195
6.14 Remote Controller Thermistor Abnormality	196
6.15 Signal Transmission Error (Between Indoor Unit and Outdoor Unit)....	197

6.16	Signal Transmission Error (Between Indoor Unit and Remote Controller).....	199
6.17	Signal Transmission Error (Between MAIN/SUB Remote Controllers).....	200
6.18	Unspecified Voltage (Between Indoor Unit and Outdoor Unit).....	201
6.19	Address Duplication of Centralized Controller.....	202
7.	Troubleshooting for Floor Standing Type.....	203
7.1	Refrigerant Leak Detection.....	203
7.2	Indoor Unit PCB Abnormality.....	208
7.3	Freeze-up Protection Control/Heating Peak-cut Control.....	210
7.4	Indoor Fan Motor (DC Motor) or Related Abnormality.....	211
7.5	Thermistor or Related Abnormality (Indoor Unit).....	212
7.6	Room Temperature Sensor Abnormality/Humidity Sensor Abnormality.....	213
7.7	Refrigerant Leak Detection Sensor Failure or Disconnection.....	214
7.8	Low-voltage Detection or Over-voltage Detection.....	215
7.9	Signal Transmission Error (Between Indoor Unit and Outdoor Unit)....	217
7.10	Unspecified Voltage (Between Indoor Unit and Outdoor Unit).....	219
8.	Troubleshooting for Air Handling Units.....	220
8.1	External Protection Device Abnormality.....	220
8.2	Refrigerant Leak Detection (Confirmed) (CMXV Only).....	221
8.3	Refrigerant Leak Detection (Monitoring).....	222
8.4	Indoor Unit PCB Abnormality.....	223
8.5	Blower Motor Not Running.....	224
8.6	Indoor Fan Motor Status Abnormality.....	225
8.7	Low Indoor Airflow.....	226
8.8	Defective Capacity Setting.....	227
8.9	Blower Motor Communication Error.....	228
8.10	Thermistor/Pressure Sensor or Related Abnormality.....	229
8.11	Blower Motor HP Mismatch.....	230
8.12	Refrigerant Leak Detection Sensor Failure (CMXV Only).....	231
8.13	Refrigerant Leak Detection Sensor Disconnection (CMXV Only).....	232
8.14	Signal Transmission Error (Between Indoor Unit and Outdoor Unit)....	233
8.15	Signal Transmission Error (Between Indoor Unit and Remote Controller).....	235
8.16	Unspecified Voltage (Between Indoor Unit and Outdoor Unit).....	236
8.17	Incorrect Electric Heater Capacity Setting.....	237
9.	Troubleshooting for Outdoor Unit.....	238
9.1	Refrigerant Shortage.....	238
9.2	Low-voltage Detection or Over-voltage Detection.....	241
9.3	Wiring Error Check Unexecuted.....	243
9.4	Unspecified Voltage (Between Indoor Unit and Outdoor Unit), Anti-icing Control in Other Rooms.....	244
9.5	Anti-icing Control for Indoor Unit.....	245
9.6	Outdoor Unit PCB Abnormality.....	247
9.7	Actuation of High Pressure Switch.....	248
9.8	OL Activation (Compressor Overload).....	249
9.9	Compressor Lock.....	251
9.10	DC Fan Lock.....	253
9.11	Input Overcurrent Detection.....	254
9.12	Electronic Expansion Valve Coil Abnormality.....	256
9.13	Four Way Valve Abnormality.....	257

9.14 Discharge Pipe Temperature Control.....	259
9.15 High Pressure Control in Cooling.....	260
9.16 System Shutdown due to Temperature Abnormality in the Compressor.....	262
9.17 Compressor Sensor System Abnormality.....	263
9.18 High Pressure Switch System Abnormality.....	265
9.19 Position Sensor Abnormality.....	266
9.20 Thermistor or Related Abnormality (Outdoor Unit).....	268
9.21 High Pressure Sensor Abnormality.....	270
9.22 Electrical Box Temperature Rise.....	271
9.23 Radiation Fin Temperature Rise.....	273
9.24 Output Overcurrent Detection.....	275
10. Check.....	278
10.1 Thermistor Resistance Check.....	278
10.2 Indoor Fan Motor Connector Check.....	279
10.3 Power Supply Waveform Check.....	281
10.4 Electronic Expansion Valve Check.....	281
10.5 Four Way Valve Performance Check.....	282
10.6 Inverter Unit Refrigerant System Check.....	283
10.7 Inverter Analyzer Check.....	283
10.8 Outdoor Fan Motor Check.....	285
10.9 Installation Condition Check.....	286
10.10 Discharge Pressure Check.....	286
10.11 Outdoor Fan System Check.....	287
10.12 Main Circuit Short Check.....	287
10.13 Capacitor Voltage Check.....	289
10.14 Power Module Check.....	290
10.15 High Pressure Sensor Check.....	292
10.16 Fan Motor Connector Check for CMXV Models.....	292
10.17 Network Troubleshooting (CMXV Only).....	296
10.18 Wiring for Daikin One Thermostat.....	296
10.19 Pressure Sensor Voltage Check.....	297
10.20 Transformer Check (CMXV Only).....	297
10.21 Duct Static Pressure Check (CMXV Only).....	298

Part 7 Trial Operation and Field Settings..... 299

1. Pump Down Operation.....	300
2. Forced Cooling Operation.....	301
3. Wiring Error Check Function.....	302
4. Trial Operation.....	304
4.1 Wall Mounted Type.....	304
4.2 Duct Concealed Type.....	306
4.3 Floor Standing Type.....	308
4.4 Air Handling Units.....	310
5. Field Settings for Wall Mounted and Floor Standing Type.....	311
5.1 When 2 Units are Installed in 1 Room.....	311
5.2 Temperature Display Switch.....	315
5.3 Service Mode of Wireless Remote Controller.....	316
6. Field Settings for Duct Concealed Type.....	321
6.1 How to Change the Field Settings.....	321
6.2 Overview of Field Settings.....	323

6.3	MAIN/SUB Setting when Using 2 Wired Remote Controllers.....	326
7.	Field Settings for Air Handling Units	327
7.1	How to Change the Field Settings.....	327
7.2	Overview of Field Settings for CMXV	327
7.3	Setting of DIP Switches (CMXV Only).....	331
8.	Field Settings for Outdoor Unit.....	332
8.1	Priority Room Setting	332
8.2	COOL/HEAT Mode Lock.....	333
8.3	NIGHT QUIET Mode	334
8.4	Drain Pan Heater.....	334
9.	Silicone Grease on Power Transistor/Diode Bridge.....	335

Part 8 Appendix..... 336



1.	Piping Diagrams.....	337
1.1	Indoor Unit.....	337
1.2	Outdoor Unit.....	340
2.	Wiring Diagrams.....	344
2.1	Indoor Unit.....	344
2.2	Outdoor Unit.....	349
3.	Operation Limit.....	359
4.	Refrigerant Leak Detection Sensor Replacement (CMXV models only)	361
5.	CMXV Refrigerant Pipe.....	362

Introduction

1. Safety Cautions.....	2
1.1 Warnings and Cautions Regarding Safety of Workers.....	2
1.2 Warnings and Cautions Regarding Safety of Users.....	7
2. Icons Used	10
3. Revision History	11

1. Safety Cautions



Be sure to read the following safety cautions before conducting repair work. After the repair work is complete, be sure to conduct a test operation to ensure that the equipment operates normally, and explain the cautions for operating the product to the customer.

	This manual is for the person in charge of maintenance and inspection.	 Refrigerant Safety Group A2L	This appliance is filled with R-32.
---	--	---	-------------------------------------







Caution Items





The caution items are classified into **Warning** and **Caution**. The **Warning** items are especially important since death or serious injury can result if they are not followed closely. The **Caution** items can also lead to serious accidents under some conditions if they are not followed. Therefore, be sure to observe all the safety caution items described below.









Pictograms

-  This symbol indicates an item for which caution must be exercised. The pictogram shows the item to which attention must be paid.
-  This symbol indicates a prohibited action. The prohibited item or action is shown in the illustration or near the symbol.
-  This symbol indicates an action that must be taken, or an instruction. The instruction is shown in the illustration or near the symbol.

1.1 Warnings and Cautions Regarding Safety of Workers

 Warning	
<p>Do not store equipment in a room with fire sources (e.g., naked flames, gas appliances, electric heaters).</p>	
<p>Be sure to disconnect the power cable from the socket before disassembling equipment for repair. Working on equipment that is connected to the power supply may cause an electrical shock. If it is necessary to supply power to the equipment to conduct the repair or inspect the circuits, do not touch any electrically charged sections of the equipment.</p>	
<p>If refrigerant gas is discharged during repair work, do not touch the discharged refrigerant gas. Refrigerant gas may cause frostbite.</p>	
<p>When disconnecting the suction or discharge pipe of the compressor at the welded section, evacuate the refrigerant gas completely at a well-ventilated place first. If there is gas remaining inside the compressor, the refrigerant gas or refrigerating machine oil discharges when the pipe is disconnected, and it may cause injury.</p>	
<p>If refrigerant gas leaks during repair work, ventilate the area. Refrigerant gas may generate toxic gases when it contacts flames.</p>	
<p>Be sure to discharge the capacitor completely before conducting repair work. The step-up capacitor supplies high-voltage electricity to the electrical components of the outdoor unit. A charged capacitor may cause an electrical shock.</p>	

 Warning	
<p>Do not turn the air conditioner on or off by plugging in or unplugging the power cable. Plugging in or unplugging the power cable to operate the equipment may cause an electrical shock or fire.</p>	
<p>Be sure to wear a safety helmet, gloves, and a safety belt when working in a high place (more than 2 m (6.5 ft)). Insufficient safety measures may cause a fall.</p>	
<p>In case of R-32 / R-410A refrigerant models, be sure to use pipes, flare nuts and tools intended for the exclusive use with the R-32 / R-410A refrigerant. The use of materials for R-22 refrigerant models may cause a serious accident, such as a damage of refrigerant cycle or equipment failure.</p>	
<p>Do not mix air or gas other than the specified refrigerant (R-32 / R-410A / R-22) in the refrigerant system. If air enters the refrigerant system, an excessively high pressure results, causing equipment damage and injury.</p>	

 Caution	
<p>Do not repair electrical components with wet hands. Working on the equipment with wet hands may cause an electrical shock.</p>	
<p>Do not clean the air conditioner with water. Washing the unit with water may cause an electrical shock.</p>	
<p>Be sure to provide an earth / grounding when repairing the equipment in a humid or wet place, to avoid electrical shocks.</p>	
<p>Be sure to turn off the power switch and unplug the power cable when cleaning the equipment. The internal fan rotates at a high speed, and may cause injury.</p>	
<p>Be sure to conduct repair work with appropriate tools. The use of inappropriate tools may cause injury.</p>	
<p>Be sure to check that the refrigerating cycle section has cooled down enough before conducting repair work. Working on the unit when the refrigerating cycle section is hot may cause burns.</p>	
<p>Conduct welding work in a well-ventilated place. Using the welder in an enclosed room may cause oxygen deficiency.</p>	

■ Checks to the area

Prior to beginning work on systems containing flammable refrigerants, safety checks are necessary to ensure that the risk of ignition is minimized. For repair to the refrigerating system, provisions under **Work procedure to No ignition sources** below shall be completed prior to conducting work on the system.

■ Work procedure

Work shall be undertaken under a controlled procedure so as to minimize the risk of a flammable gas or vapor being present while the work is being performed.

■ General work area

All maintenance staff and others working in the local area shall be instructed on the nature of work being carried out. Work in confined spaces shall be avoided.

■ Checking for presence of refrigerant

The area shall be checked with an appropriate refrigerant detector prior to and during work, to ensure the technician is aware of potentially toxic or flammable atmospheres.

Ensure that the leak detection equipment being used is suitable for use with all applicable refrigerants, i.e. non-sparking, adequately sealed or intrinsically safe.

■ Presence of fire extinguisher

If any hot work is to be conducted on the refrigerating equipment or any associated parts, appropriate fire extinguishing equipment shall be available to hand. Have a dry powder or CO₂ fire extinguisher adjacent to the charging area.

■ No ignition sources

No person carrying out work in relation to a refrigerating system which involves exposing any pipe work shall use any sources of ignition in such a manner that it may lead to the risk of fire or explosion. All possible ignition sources, including cigarette smoking, should be kept sufficiently far away from the site of installation, repairing, removing and disposal, during which refrigerant can possibly be released to the surrounding space. Prior to work taking place, the area around the equipment is to be surveyed to make sure that there are no flammable hazards or ignition risks. "No Smoking" signs shall be displayed.

■ Ventilated area

Ensure that the area is in the open or that it is adequately ventilated before breaking into the system or conducting any hot work. A degree of ventilation shall continue during the period that the work is carried out. The ventilation should safely disperse any released refrigerant and preferably expel it externally into the atmosphere.

■ Checks to the refrigerating equipment

Where electrical components are being changed, they shall be fit for the purpose and to the correct specification.

At all times the manufacturer's maintenance and service guidelines shall be followed. If in doubt, consult the manufacturer's technical department for assistance.

The following checks shall be applied to installations using flammable refrigerants:

- The actual refrigerant charge is in accordance with the room size within which the refrigerant containing parts are installed;
- The ventilation machinery and outlets are operating adequately and are not obstructed;
- If an indirect refrigerating circuit is being used, the secondary circuit shall be checked for the presence of refrigerant;
- Marking to the equipment continues to be visible and legible. Markings and signs that are illegible shall be corrected;
- Refrigerating pipe or components are installed in a position where they are unlikely to be exposed to any substance which may corrode refrigerant containing components, unless the components are constructed of materials which are inherently resistant to being corroded or are suitably protected against being so corroded.

■ Checks to electrical devices

Repair and maintenance to electrical components shall include initial safety checks and component inspection procedures. If a fault exists that could compromise safety, then no electrical supply shall be connected to the circuit until it is satisfactorily dealt with. If the fault cannot be corrected immediately but it is necessary to continue operation, an adequate temporary solution shall be used. This shall be reported to the owner of the equipment so all parties are advised.

Initial safety checks shall include:

- that capacitors are discharged: this shall be done in a safe manner to avoid possibility of sparking;
- that no live electrical components and wiring are exposed while charging, recovering or purging the system;
- that there is continuity of earth bonding.

■ Repairs to sealed components

Sealed electrical components shall be replaced.

■ Repair to intrinsically safe components

Intrinsically safe components must be replaced.

■ Cabling

Check that cabling will not be subject to wear, corrosion, excessive pressure, vibration, sharp edges or any other adverse environmental effects. The check shall also take into account the effects of aging or continual vibration from sources such as compressors or fans.

■ Detection of flammable refrigerants

Under no circumstances shall potential sources of ignition be used in the searching for or detection of refrigerant leaks. A halide torch (or any other detector using a naked flame) shall not be used.

The following leak detection methods are deemed acceptable for all refrigerant systems. Electronic leak detectors may be used to detect refrigerant leaks but, in the case of flammable refrigerants, the sensitivity may not be adequate, or may need re-calibration. Ensure that the detector is not a potential source of ignition and is suitable for the refrigerant used. Leak detection equipment shall be set at a percentage of the LFL (lower flammability limit) of the refrigerant and shall be calibrated to the refrigerant employed, and the appropriate percentage of gas (25% maximum) is confirmed.

Leak detection fluids are also suitable for use with most refrigerants but the use of detergents containing chlorine shall be avoided as the chlorine may react with the refrigerant and corrode the copper pipe-work.

Note: Examples of leak detection fluids are

- bubble method,
- fluorescent method agents.

If a leak is suspected, all naked flames shall be removed/extinguished.

If a leakage of refrigerant is found which requires brazing, all of the refrigerant shall be recovered from the system, or isolated (by means of shut off valves) in a part of the system remote from the leak. Removal of refrigerant shall be according to the following clause,

Removal and evacuation.**■ Removal and evacuation**

When breaking into the refrigerant circuit to make repairs – or for any other purpose – conventional procedures shall be used. However, for flammable refrigerants it is important that best practice be followed, since flammability is a consideration. The following procedure shall be adhered to:

- safely remove refrigerant following local and national regulations;
- evacuate;
- purge the circuit with inert gas (optional for A2L);
- evacuate (optional for A2L);

- continuously flush or purge with inert gas when using flame to open circuit;
- open the circuit.

The refrigerant charge shall be recovered into the correct recovery cylinders if venting is not allowed by local and national codes. For appliances containing flammable refrigerants, the system shall be purged with oxygen-free nitrogen to render the appliance safe for flammable refrigerants. This process might need to be repeated several times. Compressed air or oxygen shall not be used for purging refrigerant systems.

For appliances containing flammable refrigerants, refrigerants purging shall be achieved by breaking the vacuum in the system with oxygen-free nitrogen and continuing to fill until the working pressure is achieved, then venting to atmosphere, and finally pulling down to a vacuum (optional for A2L). This process shall be repeated until no refrigerant is within the system (optional for A2L). When the final oxygen-free nitrogen charge is used, the system shall be vented down to atmospheric pressure to enable work to take place.

The outlet for the vacuum pump shall not be close to any potential ignition sources, and ventilation shall be available.

■ Charging procedures

In addition to conventional charging procedures, the following requirements shall be followed.

Ensure that contamination of different refrigerants does not occur when using charging equipment. Hoses or lines shall be as short as possible to minimize the amount of refrigerant contained in them.

- Cylinders shall be kept in an appropriate position according to the instructions.
- Ensure that the refrigerating system is earthed prior to charging the system with refrigerant.
- Label the system when charging is complete (if not already).
- Extreme care shall be taken not to overfill the refrigerating system.
- Prior to recharging the system, it shall be pressure-tested with the appropriate purging gas.

The system shall be leak-tested on completion of charging but prior to commissioning. A follow up leak test shall be carried out prior to leaving the site.

■ Decommissioning

Before carrying out this procedure, it is essential that the technician is completely familiar with the equipment and all its detail. It is recommended good practice that all refrigerants are recovered safely. Prior to the task being carried out, an oil and refrigerant sample shall be taken in case analysis is required prior to re-use of recovered refrigerant. It is essential that electrical power is available before the task is commenced.

- a) Become familiar with the equipment and its operation.
- b) Isolate system electrically.
- c) Before attempting the procedure, ensure that:
 - ◆ mechanical handling equipment is available, if required, for handling refrigerant cylinders;
 - ◆ all personal protective equipment is available and being used correctly;
 - ◆ the recovery process is supervised at all times by a competent person;
 - ◆ recovery equipment and cylinders conform to the appropriate standards.
- d) Pump down refrigerant system, if possible.
- e) If a vacuum is not possible, make a manifold so that refrigerant can be removed from various parts of the system.
- f) Make sure that cylinder is situated on the scales before recovery takes place.
- g) Start the recovery machine and operate in accordance with instructions.
- h) Do not overfill cylinders (no more than 80% volume liquid charge).
- i) Do not exceed the maximum working pressure of the cylinder, even temporarily.
- j) When the cylinders have been filled correctly and the process completed, make sure that the cylinders and the equipment are removed from site promptly and all isolation valves on the equipment are closed off.
- k) Recovered refrigerant shall not be charged into another refrigerating system unless it has been cleaned and checked.

■ **Labelling**

Equipment shall be labelled stating that it has been de-commissioned and emptied of refrigerant. The label shall be dated and signed. For appliances containing flammable refrigerants, ensure that there are labels on the equipment stating the equipment contains flammable refrigerant.

■ **Recovery**

When removing refrigerant from a system, either for servicing or decommissioning, it is recommended good practice that all refrigerants are removed safely.







When transferring refrigerant into cylinders, ensure that only appropriate refrigerant recovery cylinders are employed. Ensure that the correct number of cylinders for holding the total system charge is available. All cylinders to be used are designated for the recovered refrigerant and labelled for that refrigerant (i.e. special cylinders for the recovery of refrigerant). Cylinders shall be complete with pressure-relief valve and associated shut-off valves in good working order. Empty recovery cylinders are evacuated and, if possible, cooled before recovery occurs.









The recovery equipment shall be in good working order with a set of instructions concerning the equipment that is at hand and shall be suitable for the recovery of the flammable refrigerant. If in doubt, the manufacturer should be consulted. In addition, a set of calibrated weighing scales shall be available and in good working order. Hoses shall be complete with leak-free disconnect couplings and in good condition.





The recovered refrigerant shall be processed according to local legislation in the correct recovery cylinder, and the relevant waste transfer note arranged. Do not mix refrigerants in recovery units and especially not in cylinders.







If compressors or compressor oils are to be removed, ensure that they have been evacuated to an acceptable level to make certain that flammable refrigerant does not remain within the lubricant. The compressor body shall not be heated by an open flame or other ignition sources to accelerate this process. When oil is drained from a system, it shall be carried out safely.

1.2 Warnings and Cautions Regarding Safety of Users

 Warning	
Do not store the equipment in a room with fire sources (e.g., naked flames, gas appliances, electric heaters).	
Be sure to use parts listed in the service parts list of the applicable model and appropriate tools to conduct repair work. Never attempt to modify the equipment. The use of inappropriate parts or tools may cause an electrical shock, excessive heat generation or fire.	
If the power cable and lead wires are scratched or have deteriorated, be sure to replace them. Damaged cable and wires may cause an electrical shock, excessive heat generation or fire.	
Do not use a joined power cable or extension cable, or share the same power outlet with other electrical appliances, since it may cause an electrical shock, excessive heat generation or fire.	
Be sure to use an exclusive power circuit for the equipment, and follow the local technical standards related to the electrical equipment, the internal wiring regulations, and the instruction manual for installation when conducting electrical work. Insufficient power circuit capacity and improper electrical work may cause an electrical shock or fire.	





 Warning	
<p>Be sure to use the specified cable for wiring between the indoor and outdoor units. Make the connections securely and route the cable properly so that there is no force pulling the cable at the connection terminals. Improper connections may cause excessive heat generation or fire.</p>	
<p>When wiring between the indoor and outdoor units, make sure that the terminal cover does not lift off or dismount because of the cable. If the cover is not mounted properly, the terminal connection section may cause an electrical shock, excessive heat generation or fire.</p>	
<p>Do not damage or modify the power cable. Damaged or modified power cables may cause an electrical shock or fire. Placing heavy items on the power cable, or heating or pulling the power cable may damage it.</p>	
<p>Do not mix air or gas other than the specified refrigerant (R-32 / R-410A / R- 22) in the refrigerant system. If air enters the refrigerant system, an excessively high pressure results, causing equipment damage and injury.</p>	
<p>If the refrigerant gas leaks, be sure to locate the leaking point and repair it before charging the refrigerant. After charging the refrigerant, make sure that there is no leak. If the leaking point cannot be located and the repair work must be stopped, be sure to pump-down, and close the service valve, to prevent refrigerant gas from leaking into the room. Refrigerant gas itself is harmless, but it may generate toxic gases when it contacts flames, such as those from fan type and other heaters, stoves and ranges.</p>	
<p>When relocating the equipment, make sure that the new installation site has sufficient strength to withstand the weight of the equipment. If the installation site does not have sufficient strength or the installation work is not conducted securely, the equipment may fall and cause injury.</p>	
<p>Check to make sure that the power cable plug is not dirty or loose, then insert the plug into a power outlet securely. If the plug is dusty or has a loose connection, it may cause an electrical shock or fire.</p>	
<p>When replacing the coin battery in the remote controller, be sure to dispose of the old battery to prevent children from swallowing it. If a child swallows the coin battery, see a doctor immediately.</p>	

 Caution	
<p>Installation of a leakage breaker is necessary in some cases depending on the conditions of the installation site, to prevent electrical shocks.</p>	
<p>Do not install the equipment in a place where there is a possibility of combustible gas leaks. If combustible gas leaks and remains around the unit, it may cause a fire.</p>	
<p>Check to see if parts and wires are mounted and connected properly, and if connections at the soldered or crimped terminals are secure. Improper installation and connections may cause excessive heat generation, fire or an electrical shock.</p>	

 Caution	
<p>If the installation platform or frame has corroded, replace it. A corroded installation platform or frame may cause the unit to fall, resulting in injury.</p>	
<p>Check the earth / grounding, and repair it if the equipment is not properly earthed / grounded. Improper earth / grounding may cause an electrical shock.</p>	
<p>Be sure to measure insulation resistance after the repair, and make sure that the resistance is 1 MΩ or higher. Faulty insulation may cause an electrical shock.</p>	
<p>Be sure to check the drainage of the indoor unit after the repair. Faulty drainage may cause water to enter the room and wet the furniture and floor.</p>	
<p>Do not tilt the unit when removing it. The water inside the unit may spill and wet the furniture and floor.</p>	

2. Icons Used

The following icons are used to attract the attention of the reader to specific information.

Icon	Type of Information	Description
 Warning	Warning	Warning is used when there is danger of personal injury.
 Caution	Caution	Caution is used when there is danger that the reader, through incorrect manipulation, may damage equipment, lose data, get an unexpected result or have to restart (part of) a procedure.
 Note	Note	Note provides information that is not indispensable, but may nevertheless be valuable to the reader, such as tips and tricks.
 Reference	Reference	Reference guides the reader to other places in this binder or in this manual, where he/she will find additional information on a specific topic.

3. Revision History

Month/Year	Version	Revised contents
09 / 2024	SiUS122410E	First edition
10 / 2025	SiUS122410EA	Model addition: 5MXM48AVJU9, 3MXT24AVJU9, 4MXT36AVJU9, 5MXT40AVJU9, 3MXTH24AVJU9, 4MXTH36AVJU9, 5MXTH40AVJU9
02 / 2026	SiUS122410EB	Model addition: 2MXM18AVJU8, 3MXM24AVJU8, 4MXM36AVJU8, 5MXM48AVJU8, 2MXT18AVJU8, 3MXT24AVJU8, 4MXT36AVJU8, 5MXT40AVJU8, 2MXTH18AVJU8, 3MXTH24AVJU8, 4MXTH36AVJU8, 5MXTH40AVJU8, CDMA07AVJU9, FDMA09/12/15/18/24AVJU9, FVXV09/12/15/18AVJUW(T)9, CMXV12/18/24AVJUA

Part 1

General Information

1. Applicable Models	13
2. Functions.....	14
2.1 Indoor Unit.....	14
2.2 Outdoor Unit.....	16

1. Applicable Models

Indoor Unit

Wall mounted type	Duct concealed type	Floor standing type
CTXV07AVJU9	CDMA07AVJU9	FVXV09AVJUW9
FTXV09AVJU9	FDMA09AVJU9	FVXV09AVJUT9
FTXV12AVJU9	FDMA12AVJU9	FVXV12AVJUW9
FTXV15AVJU9	FDMA15AVJU9	FVXV12AVJUT9
FTXV18AVJU9	FDMA18AVJU9	FVXV15AVJUW9
FTXV24AVJU9	FDMA24AVJU9	FVXV15AVJUT9
		FVXV18AVJUW9
		FVXV18AVJUT9
Air handling units		
CMXV12AVJUA		
CMXV18AVJUA		
CMXV24AVJUA		

Outdoor Unit

Standard type	Cold climate type	
2MXM18AVJU9	2MXT18AVJU9	2MXTH18AVJU9 (with drain pan heater)
3MXM24AVJU9	3MXT24AVJU9	3MXTH24AVJU9 (with drain pan heater)
4MXM36AVJU9	4MXT36AVJU9	4MXTH36AVJU9 (with drain pan heater)
5MXM48AVJU9	5MXT40AVJU9	5MXTH40AVJU9 (with drain pan heater)
2MXM18AVJU8	2MXT18AVJU8	2MXTH18AVJU8 (with drain pan heater)
3MXM24AVJU8	3MXT24AVJU8	3MXTH24AVJU8 (with drain pan heater)
4MXM36AVJU8	4MXT36AVJU8	4MXTH36AVJU8 (with drain pan heater)
5MXM48AVJU8	5MXT40AVJU8	5MXTH40AVJU8 (with drain pan heater)



Note

Duct concealed type, floor standing type and air handling units cannot be connected to 2/3/4MXM-AVJU9 and 2MXT(H)18AVJU9 outdoor units.

2. Functions

2.1 Indoor Unit

Category	Functions	CTXV07AVJU9 FTXV09/12AVJU9	FTXV15/18/24AVJU9
Basic Function	Inverter (with inverter power control)	●	●
Comfortable Airflow	Power-airflow flap (horizontal blade)	●	—
	Power-airflow dual flaps (horizontal blade)	—	●
	Wide-angle louvers (vertical blades)	●	●
	Auto-swing (up and down)	●	●
	Auto-swing (left and right)	—	—
	3-D airflow	—	—
	COMFORT AIRFLOW operation	●	●
Comfort Control	Auto fan speed	●	●
	Switchable fan speed	●	●
	Indoor unit quiet operation	●	●
	INTELLIGENT EYE operation	—	—
	2-area INTELLIGENT EYE operation	—	—
	Hot-start function	●	●
Operation	Automatic cooling/heating change-over	●	●
	Program dry operation	●	●
	Fan only	●	●
Lifestyle Convenience	POWERFUL operation (inverter)	●	●
	ECONO operation	●	●
	Indoor unit ON/OFF switch	●	●
	Multi-colored indicator lamp	—	—
	Monitor brightness setting	—	—
	Signal receiving sign	●	●
	R/C with back light	●	●
Health and Cleanliness	Titanium apatite deodorizing filter	●	●
	Mold proof air filter	●	●
	Wipe-clean flat panel	●	●
	Washable grille	—	—
Timer	WEEKLY TIMER operation	—	—
	24-hour ON/OFF TIMER	—	—
	Count up-down ON/OFF timer	●	●
	NIGHT SET mode	●	●
Worry Free (Reliability & Durability)	Auto-restart (after power failure)	●	●
	Self-diagnosis (R/C, LED)	●	●
Flexibility	Multi-split/split type compatible indoor unit	●	●
	Either side drain (left or right)	●	●
	°F/°C changeover R/C temperature display (factory setting: °F)	●	●
Remote Control	Remote control adaptor (normal open pulse contact)	Option	Option
	Remote control adaptor (normal open contact)	Option	Option
	DIII-NET compatible (adaptor)	Option	Option
	Wireless LAN connection	●	●
Remote Controller	Wireless	●	●
	Wired	Option	Option

● : Available

— : Not available

Category	Functions	FDMA Series	FVXV Series	CMXV Series
Basic Function	Inverter (with inverter power control)	●	●	●
Comfort Control	Auto fan speed	●	●	●
	Switchable fan speed	3 steps	5 steps	5 steps
	Indoor unit quiet operation	—	●	—
	2 selectable temperature sensors	●	—	—
	Hot-start function	●	●	●
	INTELLIGENT EYE operation (auto energy saving)	—	—	—
	Heat Plus	—	●	—
	Floor warming	—	●	—
Comfortable Airflow	Auto-Swing (Up and Down)	—	●	—
	Wide-Angle Louvers	—	●	—
	2-Way Air flow (top and bottom)	—	●	—
Operation	Automatic cooling/heating change-over	●	●	●
	Program dry operation	●	●	●
	Fan only	●	●	—
Lifestyle Convenience	POWERFUL operation (inverter)	—	●	—
	ECONO operation	—	●	—
	Indoor unit ON/OFF switch	—	●	—
	Signal receiving sign	—	●	—
	Remote controller with back light	●	●	●
	Home leave operation	—	●	—
	Multi-colored operation lamp	—	●	—
Health and Cleanliness	Titanium apatite deodorizing filter	—	Option	—
	Air filter	—	●	—
	Filter cleaning indicator	●	—	—
	Silver ion anti-bacterial drain pan	●	—	—
	Clean operation	—	●	—
Timer	WEEKLY TIMER operation	—	●	Refer to the following link for details. https://daikin.comfort.com/pro
	Schedule timer	●	Option	
	Setpoint auto reset	—	—	
	Setpoint range set	●	—	
	24-hour ON/OFF TIMER	—	●	
	72-hour ON/OFF TIMER	—	—	
	Off timer (turns unit off after set time)	—	●	
	NIGHT SET mode	—	●	
Worry Free (Reliability & Durability)	Auto-restart (after power failure)	●	●	●
	Self-diagnosis (Remote controller, LED)	●	●	●
Flexibility	Multi-split/split type compatible indoor unit	●	●	●
	Chargeless	49.2 ft. (15 m)	49.2 ft. (15 m)	49.2 ft. (15 m)
	Drain pump	●	—	—
	°F/°C changeover R/C temperature display (factory setting: °F)	●	●	●
Remote Control	Remote control adaptor (normal open pulse contact)	—	Option	—
	Remote control adaptor (normal open contact)	—	Option	—
	DIII-NET compatible (adaptor)	—	Option	—
	Wireless LAN connection	—	●	—
Remote Controller	Wireless	—	●	—
	Wired	Option	Option	Option

● : Available
 — : Not available

2.2 Outdoor Unit

Function	Standard		Cold Climate			
	2MXM	3/4/5MXM	2MXT	3/4/5MXT	2MXTH	3/4/5MXTH
Inverter (with inverter power control)	●	●	●	●	●	●
Operation limit	Refer to P. 359					
PAM control	●	●	●	●	●	●
Standby electricity saving	—	—	—	—	—	—
Swing compressor	●	●	●	●	●	●
Reluctance DC motor	●	●	●	●	●	●
NIGHT QUIET mode	●	●	●	●	●	●
QUIET OUTDOOR UNIT operation	●	●	●	●	●	●
Quick warming function	—	—	—	—	—	—
Automatic defrosting	●	●	●	●	●	●
Defrost learning control	—	—	—	—	—	—
Priority room setting	●	●	●	●	●	●
COOL/HEAT mode lock	●	●	●	●	●	●
Self-diagnosis (R/C, LED)	●	●	●	●	●	●
Wiring error check function	●	●	●	●	●	●
Anti-corrosion treatment of outdoor heat exchanger	●	●	●	●	●	●
Drain pan heater	Option	Option	Option	Option	●	●
Drain pan heater control by microcomputer	●	●	●	●	●	●
Chargeless	98.4 ft (30 m)	131.2 ft (40 m)	98.4 ft (30 m)	131.2 ft (40 m)	98.4 ft (30 m)	131.2 ft (40 m)
Low temp. cooling operation (-15°C) (5°F)	—	—	—	—	—	—

● : Available

— : Not available

Part 2 Specifications

1. Specifications	18
1.1 Indoor Unit.....	18
1.2 Outdoor Unit.....	25

1. Specifications

1.1 Indoor Unit

1.1.1 Wall Mounted Type

Model			CTXV07AVJU9		FTXV09AVJU9	
			Cooling	Heating	Cooling	Heating
Power Supply	Phase		1 φ		1 φ	
	Hz, V		60 Hz, 208 - 230 V		60 Hz, 208 - 230 V	
Rated Capacity			7 kBtu/h Class		9 kBtu/h Class	
Front Panel Color (Munsell No.)			White (N9.5)		White (N9.5)	
Airflow Rates	H	cfm (m³/min)	332 (9.4)	332 (9.4)	381 (10.8)	385 (10.9)
	M		268 (7.6)	279 (7.9)	272 (7.7)	304 (8.6)
	L		230 (6.5)	230 (6.5)	230 (6.5)	230 (6.5)
	SL		166 (4.7)	194 (5.5)	166 (4.7)	194 (5.5)
Fan	Type		Cross Flow Fan		Cross Flow Fan	
	Drive Input	A	0.20		0.20	
	Speed	Steps	5 Steps, Quiet, Auto		5 Steps, Quiet, Auto	
Air Direction Control			Right, Left, Horizontal, Downward		Right, Left, Horizontal, Downward	
Air Filter			Removable, Washable		Removable, Washable	
Running Current (Rated)	A		0.11 - 0.10	0.12 - 0.11	0.14 - 0.13	0.13 - 0.12
Power Consumption (Rated)	W		20 - 20	23 - 23	26 - 26	25 - 25
Power Factor (Rated)	%		87.0 - 90.3	94.0 - 91.3	90.4 - 86.2	90.9 - 87.3
Temperature Control			Microcomputer Control		Microcomputer Control	
Dimensions (H × W × D)	in. (mm)		11-1/4 × 30-5/16 × 8-3/4 (286 × 770 × 223)		11-1/4 × 30-5/16 × 8-3/4 (286 × 770 × 223)	
Packaged Dimensions (H × W × D)	in. (mm)		12-5/8 × 32-11/16 × 14-3/16 (320 × 830 × 360)		12-5/8 × 32-11/16 × 14-3/16 (320 × 830 × 360)	
Weight (Mass)	lbs (kg)		19 (9)		19 (9)	
Gross Weight (Gross Mass)	lbs (kg)		24 (11)		24 (11)	
Sound Pressure Level	H / M / L / SL	dB(A)	40 / 35 / 31 / 24	39 / 34 / 28 / 25	43 / 35 / 31 / 24	41 / 35 / 28 / 25
Heat Insulation			Both Liquid and Gas Pipes		Both Liquid and Gas Pipes	
Piping Connection	Liquid	in. (mm)	φ 1/4 (φ 6.4)		φ 1/4 (φ 6.4)	
	Gas	in. (mm)	φ 3/8 (φ 9.5)		φ 3/8 (φ 9.5)	
	Drain	in. (mm)	φ 5/8 (φ 16)		φ 5/8 (φ 16)	
Drawing No.			3D153215A		3D153215A	
Note			SL: The quiet fan level of the airflow rate setting.		SL: The quiet fan level of the airflow rate setting.	

Model			FTXV12AVJU9		FTXV15AVJU9	
			Cooling	Heating	Cooling	Heating
Power Supply	Phase		1 φ		1 φ	
	Hz, V		60 Hz, 208 - 230 V		60 Hz, 208 - 230 V	
Rated Capacity			12 kBtu/h Class		15 kBtu/h Class	
Front Panel Color (Munsell No.)			White (N9.5)		White (N9.5)	
Airflow Rates	H	cfm (m³/min)	392 (11.1)	438 (12.4)	540 (15.3)	636 (18.0)
	M		293 (8.3)	318 (9.0)	470 (13.3)	537 (15.2)
	L		226 (6.4)	240 (6.8)	381 (10.8)	452 (12.8)
	SL		166 (4.7)	205 (5.8)	339 (9.6)	388 (11.0)
Fan	Type		Cross Flow Fan		Cross Flow Fan	
	Drive Input	A	0.23		0.31	
	Speed	Steps	5 Steps, Quiet, Auto		5 Steps, Quiet, Auto	
Air Direction Control			Right, Left, Horizontal, Downward		Right, Left, Horizontal, Downward	
Air Filter			Removable, Washable		Removable, Washable	
Running Current (Rated)	A		0.17 - 0.15	0.20 - 0.18	0.19 - 0.17	0.20 - 0.18
Power Consumption (Rated)	W		29 - 29	35 - 35	36 - 36	39 - 39
Power Factor (Rated)	%		81.3 - 84.7	83.7 - 82.7	91.1 - 93.5	93.8 - 92.3
Temperature Control			Microcomputer Control		Microcomputer Control	
Dimensions (H × W × D)	in. (mm)		11-1/4 × 30-5/16 × 8-3/4 (286 × 770 × 223)		11-5/8 × 39 × 10-3/8 (295 × 990 × 263)	
Packaged Dimensions (H × W × D)	in. (mm)		12-5/8 × 32-11/16 × 14-3/16 (320 × 830 × 360)		15-3/16 × 43-3/8 × 15-5/16 (386 × 1,102 × 389)	
Weight (Mass)	lbs (kg)		19 (9)		27 (13)	
Gross Weight (Gross Mass)	lbs (kg)		24 (11)		37 (17)	
Sound Pressure Level	H / M / L / SL	dB(A)	45 / 37 / 31 / 24	45 / 37 / 30 / 26	45 / 41 / 36 / 33	45 / 41 / 37 / 33
Heat Insulation			Both Liquid and Gas Pipes		Both Liquid and Gas Pipes	
Piping Connection	Liquid	in. (mm)	φ 1/4 (φ 6.4)		φ 1/4 (φ 6.4)	
	Gas	in. (mm)	φ 3/8 (φ 9.5)		φ 1/2 (φ 12.7)	
	Drain	in. (mm)	φ 5/8 (φ 16)		φ 5/8 (φ 16)	
Drawing No.			3D153215A		3D153178A	
Note			SL: The quiet fan level of the airflow rate setting.		SL: The quiet fan level of the airflow rate setting.	

Conversion Formulae
kcal/h = kW × 860
Btu/h = kW × 3412
cfm = m³/min × 35.3

Model			FTXV18AVJU9		FTXV24AVJU9	
			Cooling	Heating	Cooling	Heating
Power Supply	Phase	1 ϕ		1 ϕ		
	Hz, V	60 Hz, 208 - 230 V		60 Hz, 208 - 230 V		
Rated Capacity			18 kBtu/h Class		24 kBtu/h Class	
Front Panel Color (Munsell No.)			White (N9.5)		White (N9.5)	
Airflow Rates	H	cfm (m ³ /min)	565 (16.0)	717 (20.3)	629 (17.8)	717 (20.3)
	M		463 (13.1)	572 (16.2)	501 (14.2)	572 (16.2)
	L		378 (10.7)	452 (12.8)	378 (10.7)	466 (13.2)
	SL		335 (9.5)	388 (11.0)	335 (9.5)	413 (11.7)
Fan	Type	Cross Flow Fan		Cross Flow Fan		
	Drive Input	A	0.40	0.45		
	Speed	Steps	5 Steps, Quiet, Auto		5 Steps, Quiet, Auto	
Air Direction Control			Right, Left, Horizontal, Downward		Right, Left, Horizontal, Downward	
Air Filter			Removable, Washable		Removable, Washable	
Running Current (Rated)	A	0.20 - 0.18	0.29 - 0.26	0.31 - 0.28	0.30 - 0.27	
Power Consumption (Rated)	W	39 - 39	54 - 54	57 - 57	55 - 55	
Power Factor (Rated)	%	93.8 - 92.5	89.5 - 89.3	88.4 - 88.7	88.1 - 89.3	
Temperature Control			Microcomputer Control		Microcomputer Control	
Dimensions (H x W x D)	in. (mm)	11-5/8 x 39 x 10-3/8 (295 x 990 x 263)		11-5/8 x 39 x 10-3/8 (295 x 990 x 263)		
Packaged Dimensions (H x W x D)	in. (mm)	15-3/16 x 43-3/8 x 15-5/16 (386 x 1,102 x 389)		15-3/16 x 43-3/8 x 15-5/16 (386 x 1,102 x 389)		
Weight (Mass)	lbs (kg)	27 (13)		27 (13)		
Gross Weight (Gross Mass)	lbs (kg)	37 (17)		37 (17)		
Sound Pressure Level	H / M / L / SL	dB(A)	48 / 43 / 38 / 33	49 / 42 / 37 / 33	52 / 45 / 39 / 34	49 / 43 / 38 / 34
Heat Insulation			Both Liquid and Gas Pipes		Both Liquid and Gas Pipes	
Piping Connection	Liquid	in. (mm)	ϕ 1/4 (ϕ 6.4)		ϕ 1/4 (ϕ 6.4)	
	Gas	in. (mm)	ϕ 1/2 (ϕ 12.7)		ϕ 5/8 (ϕ 15.9)	
	Drain	in. (mm)	ϕ 5/8 (ϕ 16)		ϕ 5/8 (ϕ 16)	
Drawing No.			3D153178A		3D153178A	
Note			SL: The quiet fan level of the airflow rate setting.		SL: The quiet fan level of the airflow rate setting.	

Conversion Formulae
kcal/h = kW x 860
Btu/h = kW x 3412
cfm = m ³ /min x 35.3

1.1.2 Duct Concealed Type

Model			CDMA07AVJU9		FDMA09AVJU9	
			Cooling	Heating	Cooling	Heating
Power Supply	Phase		1φ		1φ	
	Hz, V		60 Hz, 208 - 230 V		60 Hz, 208 - 230 V	
Rated Capacity			7 kBtu/h Class		9 kBtu/h Class	
Front Panel Color (Mancel No.)			—		—	
Heat Exchanger	Rows × Stages, Fin per Inch		3 × 26, 18		3 × 26, 18	
	Fin Spec / Tube		Multi Slit Fin / φ5 Hi-XA Tube		Multi Slit Fin / φ5 Hi-XA Tube	
Airflow Rate	H / M / L	cfm	325 / 301 / 278	325 / 301 / 278	401 / 338 / 279	401 / 338 / 279
		m ³ /min	9.2 / 8.5 / 7.9	9.2 / 8.5 / 7.9	11.4 / 9.6 / 7.9	11.35 / 9.6 / 7.9
Fan Motor	H / M / L	rpm	1,031 / 956 / 881	1,031 / 956 / 881	1,128 / 956 / 784	1,128 / 956 / 784
		Drive input	A	0.39		0.52
Fan	Type		Sirocco Fan		Sirocco Fan	
External Static Pressure	inH ₂ O		Standard 0.20 (0.60 - 0.12)		Standard 0.20 (0.60 - 0.12)	
		Pa	Standard 50 (150 - 30)		Standard 50 (150 - 30)	
Running Current (Rated)	A	0.39 - 0.35	0.39 - 0.35		0.53 - 0.48	0.53 - 0.48
Power Consumption (Rated)	W	54 - 54	54 - 54		96 - 96	96 - 96
Power Factor (Rated)	%	66.6 - 66.8	66.6 - 66.8		86.9 - 87.0	86.9 - 87.0
Temperature Control			Microcomputer Control		Microcomputer Control	
Dimensions (H × W × D)	in. (mm)		9-5/8 × 27-9/16 × 31-1/2 (245 × 700 × 800)		9-5/8 × 27-9/16 × 31-1/2 (245 × 700 × 800)	
Packaged Dimensions (H × W × D)	in. (mm)		11-9/16 × 35-3/8 × 34-7/8 (293 × 899 × 886)		11-9/16 × 35-3/8 × 34-7/8 (293 × 899 × 886)	
Weight (Mass)	lbs (kg)		64 (29)		64 (29)	
Gross Weight (Gross Mass)	lbs (kg)		71 (32)		71 (32)	
Sound Pressure Level	dB(A)		30	30	32	32
Remote Controller (Option)	Wired		BRC1NRV71		BRC1NRV71	
	Wireless		—		—	
Heat Insulation			Both Liquid and Gas Pipes		Both Liquid and Gas Pipes	
Piping Connection	Liquid	in. (mm)	φ 1/4 (φ 6.4)		φ 1/4 (φ 6.4)	
	Gas	in. (mm)	φ 3/8 (φ 9.5)		φ 3/8 (φ 9.5)	
	Drain	in. (mm)	I.D. φ1 (25) / O.D. φ1-1/4 (32)		I.D. φ1 (25) / O.D. φ1-1/4 (32)	
Drawing No.			C: 3D161724A		C: 3D159367	
Note			SL: The quiet fan level of the airflow rate setting. External static pressure is changeable in 13 stages by remote controller. Air filter is not standard accessory, but please mount it in the duct system of the suction side. Select its dust collection efficiency (gravity method) 50% or more.			

Model			FDMA12AVJU9		FDMA15AVJU9	
			Cooling	Heating	Cooling	Heating
Power Supply	Phase		1φ		1φ	
	Hz, V		60 Hz, 208 - 230 V		60 Hz, 208 - 230 V	
Rated Capacity			12 kBtu/h Class		15 kBtu/h Class	
Front Panel Color (Mancel No.)			—		—	
Heat Exchanger	Rows × Stages, Fin per Inch		3 × 26, 18		3 × 26, 18	
	Fin Spec / Tube		Multi Slit Fin / φ5 Hi-XA Tube		Multi Slit Fin / φ5 Hi-XA Tube	
Airflow Rate	H / M / L	cfm	440 / 367 / 299	440 / 367 / 299	471 / 382 / 284	471 / 382 / 284
		m ³ /min	12.5 / 10.4 / 8.5	12.45 / 10.4 / 8.5	13.4 / 10.8 / 8.0	13.4 / 10.8 / 8.0
Fan Motor	H / M / L	rpm	1,179 / 992 / 805	1,179 / 992 / 805	1,019 / 862 / 704	1,019 / 862 / 704
		Drive input	A	0.61		0.87
Fan	Type		Sirocco Fan		Sirocco Fan	
External Static Pressure	inH ₂ O		Standard 0.20 (0.60 - 0.12)		Standard 0.20 (0.60 - 0.20)	
		Pa	Standard 50 (150 - 30)		Standard 50 (150 - 50)	
Running Current (Rated)	A	0.56 - 0.51	0.56 - 0.51		0.62 - 0.56	0.62 - 0.56
Power Consumption (Rated)	W	108 - 108	108 - 108		115 - 115	115 - 115
Power Factor (Rated)	%	92.6 - 91.2	92.6 - 91.2		89.1 - 89.3	89.1 - 89.3
Temperature Control			Microcomputer Control		Microcomputer Control	
Dimensions (H × W × D)	in. (mm)		9-5/8 × 27-9/16 × 31-1/2 (245 × 700 × 800)		9-5/8 × 39-3/8 × 31-1/2 (245 × 1,000 × 800)	
Packaged Dimensions (H × W × D)	in. (mm)		11-9/16 × 35-3/8 × 34-7/8 (293 × 899 × 886)		11-9/16 × 47-3/16 × 34-7/8 (293 × 1,199 × 886)	
Weight (Mass)	lbs (kg)		64 (29)		82 (37)	
Gross Weight (Gross Mass)	lbs (kg)		71 (32)		88 (40)	
Sound Pressure Level	dB(A)		33	33	34	34
Remote Controller (Option)	Wired		BRC1NRV71		BRC1NRV71	
	Wireless		—		—	
Heat Insulation			Both Liquid and Gas Pipes		Both Liquid and Gas Pipes	
Piping Connection	Liquid	in. (mm)	φ 1/4 (φ 6.4)		φ1/4 (6.4)	
	Gas	in. (mm)	φ 3/8 (φ 9.5)		φ1/2 (12.7)	
	Drain	in. (mm)	I.D. φ1 (25) / O.D. φ1-1/4 (32)		I.D. φ1 (25) / O.D. φ1-1/4 (32)	
Drawing No.			C: 3D159367		C: 3D159368	
Note			SL: The quiet fan level of the airflow rate setting. External static pressure is changeable in 13 stages by remote controller. Air filter is not standard accessory, but please mount it in the duct system of the suction side. Select its dust collection efficiency (gravity method) 50% or more.			

Conversion Formulae
kcal/h = kW × 860
Btu/h = kW × 3412
cfm = m ³ /min × 35.3

Model		FDMA18AVJU9		FDMA24AVJU9	
		Cooling	Heating	Cooling	Heating
Power Supply	Phase	1 ϕ		1 ϕ	
	Hz, V	60 Hz, 208 - 230 V		60 Hz, 208 - 230 V	
Rated Capacity		18 kBtu/h Class		24 kBtu/h Class	
Front Panel Color (Mancel No.)		—		—	
Heat Exchanger	Rows \times Stages, Fin per Inch	3 \times 26, 18		3 \times 26, 18	
	Fin Spec / Tube	Multi Slit Fin / ϕ 5 HI-XA Tube		Multi Slit Fin / ϕ 5 HI-XA Tube	
Airflow Rate	H / M / L	cfm	609 / 498 / 373	609 / 498 / 373	666 / 553 / 426
		m ³ /min	17.3 / 14.1 / 10.6	17.25 / 14.1 / 10.6	18.9 / 15.7 / 12.1
Fan Motor	H / M / L	rpm	1,100 / 936 / 762	1,110 / 936 / 762	1,153 / 980 / 807
	Drive input	A	1.12		1.24
Fan		Sirocco Fan		Sirocco Fan	
External Static Pressure	inH ₂ O	Standard 0.20 (0.60 - 0.20)		Standard 0.20 (0.60 - 0.20)	
	Pa	Standard 50 (150 - 50)		Standard 50 (150 - 50)	
Running Current (Rated)	A	0.75 - 0.68	0.75 - 0.68	0.81 - 0.73	0.81 - 0.73
Power Consumption (Rated)	W	148 - 148	148 - 148	164 - 164	164 - 164
Power Factor (Rated)	%	94.6 - 94.8	94.6 - 94.8	97.5 - 97.2	97.5 - 97.2
Temperature Control		Microcomputer Control		Microcomputer Control	
Dimensions (H \times W \times D)	in. (mm)	9-5/8 \times 39-3/8 \times 31-1/2 (245 \times 1,000 \times 800)		9-5/8 \times 39-3/8 \times 31-1/2 (245 \times 1,000 \times 800)	
Packaged Dimensions (H \times W \times D)	in. (mm)	11-9/16 \times 47-3/16 \times 34-7/8 (293 \times 1,199 \times 886)		11-9/16 \times 47-3/16 \times 34-7/8 (293 \times 1,199 \times 886)	
Weight (Mass)	lbs (kg)	82 (37)		82 (37)	
Gross Weight (Gross Mass)	lbs (kg)	88 (40)		88 (40)	
Sound Pressure Level	dB(A)	35	35	40	40
Remote Controller (Option)	Wired	BRC1NRV71		BRC1NRV71	
	Wireless	—		—	
Heat Insulation		Both Liquid and Gas Pipes		Both Liquid and Gas Pipes	
Piping Connection	Liquid	in. (mm)	ϕ 1/4 (ϕ 6.4)		ϕ 1/4 (6.4)
	Gas	in. (mm)	ϕ 1/2 (12.7)		ϕ 5/8 (15.9)
	Drain	in. (mm)	I.D. ϕ 1 (25) / O.D. ϕ 1-1/4 (32)		I.D. ϕ 1 (25) / O.D. ϕ 1-1/4 (32)
Drawing No.		C: 3D159368		C: 3D159368	
Note		SL: The quiet fan level of the airflow rate setting. External static pressure is changeable in 13 stages by remote controller. Air filter is not standard accessory, but please mount it in the duct system of the suction side. Select its dust collection efficiency (gravity method) 50% or more.			

Conversion Formulae
kcal/h = kW \times 860
Btu/h = kW \times 3412
cfm = m ³ /min \times 35.3

1.1.3 Floor Standing Type

Model			FVXV09AVJUW9				FVXV09AVJUT9					
			Cooling		Heating		Cooling		Heating			
Power Supply	Phase		1φ				1φ					
	Hz, V		60 Hz, 208 - 230 V				60 Hz, 208 - 230 V					
Rated Capacity			9 kBtu/h Class				9 kBtu/h Class					
Front Panel Color (Mancel No.)			White (N9.5)				Espresso (B-690)					
Heat Exchanger	Rows × Stages, Fin per Inch		2 × 22, 21				2 × 22, 21					
	Fin Spec / Tube		Multi Slit Fin / φ5 Hi-XB Tube				Multi Slit Fin / φ5 Hi-XB Tube					
Airflow Rate	H / M / L / SL	cfm	297 / 265 / 201 / 173		321 / 261 / 219 / 191		297 / 265 / 201 / 173		321 / 261 / 219 / 191			
		m ³ /min	8.4 / 7.5 / 5.7 / 4.9		9.1 / 7.4 / 6.2 / 5.4		8.4 / 7.5 / 5.7 / 4.9		9.1 / 7.4 / 6.2 / 5.4			
Air Direction Control			Right, Left, Upward, Downward				Right, Left, Upward, Downward					
Air Filter			Removable, Washable, Mildew Proof				Removable, Washable, Mildew Proof					
Fan Motor	H / M / L / SL	rpm	650 / 590 / 460 / 410		700 / 580 / 500 / 440		650 / 590 / 460 / 410		700 / 580 / 500 / 440			
	Motor output		Hp		0.05		0.05		0.05			
Fan			Turbo Fan				Turbo Fan					
Running Current (Rated)			A		0.08 - 0.07		0.10 - 0.09		0.08 - 0.07		0.10 - 0.09	
Power Consumption (Rated)			W		9 - 9		11 - 11		9 - 9		11 - 11	
Power Factor (Rated)			%		48.0 - 56.3		48.0 - 54.2		48.0 - 56.3		48.0 - 54.2	
Temperature Control			Microcomputer Control				Microcomputer Control					
Dimensions (H × W × D)			in. (mm)		23-5/8 × 29-1/2 × 9-3/8 (600 × 750 × 238)				23-5/8 × 29-1/2 × 9-3/8 (600 × 750 × 238)			
Packaged Dimensions (H × W × D)			in. (mm)		29-5/16 × 34-7/16 × 133-5/8 (757 × 874 × 346)				29-5/16 × 34-7/16 × 133-5/8 (757 × 874 × 346)			
Weight (Mass)			lbs (kg)		40 (18)				40 (18)			
Gross Weight (Gross Mass)			lbs (kg)		50 (23)				50 (23)			
Sound Pressure Level (H / M / L / SL)			dB(A)		39 / 36 / 30 / 26		40 / 35 / 31 / 26		39 / 36 / 30 / 26		40 / 35 / 31 / 26	
Remote Controller			ARC466A89				ARC466A89					
Heat Insulation			Both Liquid and Gas Pipes				Both Liquid and Gas Pipes					
Piping Connection	Liquid	in. (mm)	φ1/4 (6.4)				φ1/4 (6.4)					
	Gas	in. (mm)	φ3/8 (9.5)				φ3/8 (9.5)					
	Drain	in. (mm)	φ13/16 (20)				φ13/16 (20)					
Drawing No.							C: 3D159397A					
Note			SL: The quiet fan level of the airflow rate setting. When indoor unit is connected with multi-system outdoor unit. Please refer to the specifications of the multi-system outdoor unit to be connected.									

Model			FVXV12AVJUW9				FVXV12AVJUT9					
			Cooling		Heating		Cooling		Heating			
Power Supply	Phase		1φ				1φ					
	Hz, V		60 Hz, 208 - 230 V				60 Hz, 208 - 230 V					
Rated Capacity			12 kBtu/h Class				12 kBtu/h Class					
Front Panel Color (Mancel No.)			White (N9.5)				Espresso (B-690)					
Heat Exchanger	Rows × Stages, Fin per Inch		2 × 22, 21				2 × 22, 21					
	Fin Spec / Tube		Multi Slit Fin / φ5 Hi-XB Tube				Multi Slit Fin / φ5 Hi-XB Tube					
Airflow Rate	H / M / L / SL	cfm	321 / 265 / 201 / 173		371 / 300 / 219 / 191		321 / 265 / 201 / 173		371 / 300 / 219 / 191			
		m ³ /min	9.1 / 7.5 / 5.7 / 4.9		10.5 / 8.5 / 6.2 / 5.4		9.1 / 7.5 / 5.7 / 4.9		10.5 / 8.5 / 6.2 / 5.4			
Air Direction Control			Right, Left, Upward, Downward				Right, Left, Upward, Downward					
Air Filter			Removable, Washable, Mildew Proof				Removable, Washable, Mildew Proof					
Fan Motor	H / M / L / SL	rpm	700 / 590 / 460 / 410		800 / 660 / 500 / 440		700 / 590 / 460 / 410		800 / 660 / 500 / 440			
	Motor output		Hp		0.05		0.05		0.05			
Fan			Sirocco Fan				Sirocco Fan					
Running Current (Rated)			A		0.10 - 0.09		0.15 - 0.14		0.10 - 0.09		0.15 - 0.14	
Power Consumption (Rated)			W		11 - 11		16 - 16		11 - 11		16 - 16	
Power Factor (Rated)			%		48.0 - 54.2		48.0 - 50.7		48.0 - 54.2		48.0 - 50.7	
Temperature Control			Microcomputer Control				Microcomputer Control					
Dimensions (H × W × D)			in. (mm)		23-5/8 × 29-1/2 × 9-3/8 (600 × 750 × 238)				23-5/8 × 29-1/2 × 9-3/8 (600 × 750 × 238)			
Packaged Dimensions (H × W × D)			in. (mm)		29-13/16 × 34-7/16 × 13-5/8 (757 × 874 × 346)				29-13/16 × 34-7/16 × 13-5/8 (757 × 874 × 346)			
Weight (Mass)			lbs (kg)		40 (18)				40 (18)			
Gross Weight (Gross Mass)			lbs (kg)		50 (23)				50 (23)			
Sound Pressure Level (H / M / L / SL)			dB(A)		41 / 36 / 30 / 26		43 / 38 / 31 / 26		41 / 36 / 30 / 26		43 / 38 / 31 / 26	
Remote Controller			ARC466A89				ARC466A89					
Heat Insulation			Both Liquid and Gas Pipes				Both Liquid and Gas Pipes					
Piping Connection	Liquid	in. (mm)	φ1/4 (6.4)				φ1/4 (6.4)					
	Gas	in. (mm)	φ3/8 (9.5)				φ3/8 (9.5)					
	Drain	in. (mm)	φ13/16 (20)				φ13/16 (20)					
Drawing No.							C: 3D159398A					
Note			SL: The quiet fan level of the airflow rate setting. When indoor unit is connected with multi-system outdoor unit. Please refer to the specifications of the multi-system outdoor unit to be connected.									

Conversion Formulae	
kcal/h = kW × 860	
Btu/h = kW × 3412	
cfm = m ³ /min × 35.3	

Model			FVXV15AVJUW9		FVXV15AVJUT9	
			Cooling	Heating	Cooling	Heating
Power Supply	Phase		1 ϕ		1 ϕ	
	Hz, V		60 Hz, 208 - 230 V		60 Hz, 208 - 230 V	
Rated Capacity			15 kBtu/h Class		15 kBtu/h Class	
Front Panel Color (Mancel No.)			White (N9.5)		Espresso (B-690)	
Heat Exchanger	Rows \times Stages, Fin per Inch		2 \times 22, 21		2 \times 22, 21	
	Fin Spec / Tube		Multi Slit Fin / ϕ 5 Hi-XB Tube		Multi Slit Fin / ϕ 5 Hi-XB Tube	
Airflow Rate	H / M / L / SL	cfm	392 / 311 / 254 / 201	417 / 321 / 272 / 215	392 / 311 / 254 / 201	417 / 321 / 272 / 215
		m ³ /min	11.1 / 8.8 / 7.2 / 5.7	11.8 / 9.1 / 7.7 / 6.1	11.1 / 8.8 / 7.2 / 5.7	11.8 / 9.1 / 7.7 / 6.1
Air Direction Control			Right, Left, Upward, Downward		Right, Left, Upward, Downward	
Air Filter			Removable, Washable, Mildew Proof		Removable, Washable, Mildew Proof	
Fan Motor	H / M / L / SL	rpm	840 / 680 / 570 / 460	890 / 700 / 600 / 490	840 / 680 / 570 / 460	890 / 700 / 600 / 490
	Motor output	Hp	0.05		0.05	
Fan	Type		Sirocco Fan		Sirocco Fan	
Running Current (Rated)	A		0.17 - 0.15	0.20 - 0.18	0.17 - 0.15	0.20 - 0.18
Power Consumption (Rated)	W		19 - 19	22 - 22	19 - 19	22 - 22
Power Factor (Rated)	%		48.0 - 54.1	48.0 - 52.6	48.0 - 54.1	48.0 - 52.6
Temperature Control			Microcomputer Control		Microcomputer Control	
Dimensions (H \times W \times D)	in. (mm)		23-5/8 \times 29-1/2 \times 9-3/8 (600 \times 750 \times 238)		23-5/8 \times 29-1/2 \times 9-3/8 (600 \times 750 \times 238)	
Packaged Dimensions (H \times W \times D)	in. (mm)		29-13/16 \times 34-7/16 \times 13-5/8 (757 \times 874 \times 346)		29-13/16 \times 34-7/16 \times 13-5/8 (757 \times 874 \times 346)	
Weight (Mass)	lbs (kg)		40 (18)		40 (18)	
Gross Weight (Gross Mass)	lbs (kg)		50 (23)		50 (23)	
Sound Pressure Level (H / M / L / SL)	dB(A)		46 / 40 / 36 / 30	46 / 40 / 36 / 30	46 / 40 / 36 / 30	46 / 40 / 36 / 30
Remote Controller			ARC466A89		ARC466A89	
Heat Insulation			Both Liquid and Gas Pipes		Both Liquid and Gas Pipes	
Piping Connection	Liquid	in. (mm)	ϕ 1/4 (6.4)		ϕ 1/4 (6.4)	
	Gas	in. (mm)	ϕ 1/2 (12.7)		ϕ 1/2 (12.7)	
	Drain	in. (mm)	ϕ 13/16 (20)		ϕ 13/16 (20)	
Drawing No.			C: 3D159399A			
Note			SL: The quiet fan level of the airflow rate setting. When indoor unit is connected with multi-system outdoor unit. Please refer to the specifications of the multi-system outdoor unit to be connected.			

Model			FVXV18AVJUW9		FVXV18AVJUT9	
			Cooling	Heating	Cooling	Heating
Power Supply	Phase		1 ϕ		1 ϕ	
	Hz, V		60 Hz, 208 - 230 V		60 Hz, 208 - 230 V	
Rated Capacity			18 kBtu/h Class		18 kBtu/h Class	
Front Panel Color (Mancel No.)			White (N9.5)		Espresso (B-690)	
Heat Exchanger	Rows \times Stages, Fin per Inch		2 \times 22, 21		2 \times 22, 21	
	Fin Spec / Tube		Multi Slit Fin / ϕ 5 Hi-XB Tube		Multi Slit Fin / ϕ 5 Hi-XB Tube	
Airflow Rate	H / M / L / SL	cfm	448 / 332 / 286 / 240	455 / 360 / 290 / 240	448 / 332 / 286 / 240	455 / 360 / 290 / 240
		m ³ /min	12.7 / 9.4 / 8.1 / 6.8	12.9 / 10.2 / 8.2 / 6.8	12.7 / 9.4 / 8.1 / 6.8	12.9 / 10.2 / 8.2 / 6.8
Air Direction Control			Right, Left, Upward, Downward		Right, Left, Upward, Downward	
Air Filter			Removable, Washable, Mildew Proof		Removable, Washable, Mildew Proof	
Fan Motor	H / M / L / SL	rpm	950 / 720 / 630 / 540	970 / 780 / 640 / 540	950 / 720 / 630 / 540	970 / 780 / 640 / 540
	Motor output	Hp	0.05		0.05	
Fan	Type		Sirocco Fan		Sirocco Fan	
Running Current (Rated)	A		0.23 - 0.21	0.25 - 0.23	0.23 - 0.21	0.25 - 0.23
Power Consumption (Rated)	W		26 - 26	27 - 27	26 - 26	27 - 27
Power Factor (Rated)	%		48.0 - 53.6	48.0 - 51.7	48.0 - 53.6	48.0 - 51.7
Temperature Control			Microcomputer Control		Microcomputer Control	
Dimensions (H \times W \times D)	in. (mm)		23-5/8 \times 29-1/2 \times 9-3/8 (600 \times 750 \times 238)		23-5/8 \times 29-1/2 \times 9-3/8 (600 \times 750 \times 238)	
Packaged Dimensions (H \times W \times D)	in. (mm)		29-13/16 \times 34-7/16 \times 13-5/8 (757 \times 874 \times 346)		29-13/16 \times 34-7/16 \times 13-5/8 (757 \times 874 \times 346)	
Weight (Mass)	lbs (kg)		40 (18)		40 (18)	
Gross Weight (Gross Mass)	lbs (kg)		50 (23)		50 (23)	
Sound Pressure Level (H / M / L / SL)	dB(A)		49 / 42 / 38 / 34	49 / 43 / 37 / 33	49 / 42 / 38 / 34	49 / 43 / 37 / 33
Remote Controller			ARC466A89		ARC466A89	
Heat Insulation			Both Liquid and Gas Pipes		Both Liquid and Gas Pipes	
Piping Connection	Liquid	in. (mm)	ϕ 1/4 (6.4)		ϕ 1/4 (6.4)	
	Gas	in. (mm)	ϕ 1/2 (12.7)		ϕ 1/2 (12.7)	
	Drain	in. (mm)	ϕ 13/16 (20)		ϕ 13/16 (20)	
Drawing No.			C: 3D159400A			
Note			SL: The quiet fan level of the airflow rate setting. When indoor unit is connected with multi-system outdoor unit. Please refer to the specifications of the multi-system outdoor unit to be connected.			

Conversion Formulae
kcal/h = kW \times 860
Btu/h = kW \times 3412
cfm = m ³ /min \times 35.3

1.1.4 Air Handling Units

Model			CMXV12AVJUA	CMXV18AVJUA
Electrical Data	Phase		1 ϕ	1 ϕ
	Hz, V		60 Hz, 208 - 230 V	60 Hz, 208 - 230 V
	Minimum VAC		197	197
	Maximum VAC		253	253
Rated Capacity			12 kBtu/h Class	18 kBtu/h Class
Airflow Rates	H	cfm (m ³ /min)	400 (11.3)	600 (17)
	M		340 (9.6)	510 (14.6)
	L		280 (7.9)	420 (11.9)
	LL		250 (7)	340 (9.6)
Motor	Type		Variable Speed ECM - Constant Airflow at rated SP	Variable Speed ECM - Constant Airflow at rated SP
	Running Current (Rated)	A	1.2	1.5
	Power Consumption (Rated)	W	249	373
	HP		1/3	1/2
Blower	Dimensions (D x W)	in. (mm)	10 x 6 (254 x 152.4)	10 x 6 (254 x 152.4)
Temperature Control			Microcomputer Control	Microcomputer Control
Cabinet Dimensions (H x W x D)		in. (mm)	45 x 17.7 x 21 (1143 x 450 x 533)	45 x 17.7 x 21 (1143 x 450 x 533)
Ship Weight		lbs (kg)	110 (49.89)	112 (50.80)
Heat Insulation			Both Liquid and Gas Pipes	Both Liquid and Gas Pipes
Piping Connection	Liquid	in. (mm)	ϕ 1/4 (ϕ 6.4)	ϕ 1/4 (ϕ 6.4)
	Gas	in. (mm)	**	ϕ 1/2 (ϕ 12.7)
	Drain	in. (mm)	ϕ 3/4 (ϕ 19)	ϕ 3/4 (ϕ 19)
Note			*Available in horizontal or vertical configurations. *Field-installed electric heater kit available - refer to the installation manual for available options. *A single CMXV* unit can be powered directly by the outdoor unit (OD). *For installations requiring multiple CMXV**AVJUA units connected to one OD, an alternative wiring method must be used. Refer to the wiring diagram for details. **For CMXV12 If the connection is 1/2" (ϕ 12.7), the installer must install a 3/8" (ϕ 9.5) reducer to reduce the 1/2" (ϕ 12.7) suction line. If the connection is 3/8" (ϕ 9.5), the reducer is not required and should be disregarded.	

Model			CMXV24AVJUA
Electrical Data	Phase		1 ϕ
	Hz, V		60 Hz, 208 - 230 V
	Minimum VAC		197
	Maximum VAC		253
Rated Capacity			24 kBtu/h Class
Airflow Rates	H	cfm (m ³ /min)	800 (22.7)
	M		680 (19.3)
	L		560 (15.9)
	LL		450 (12.7)
Motor	Type		Variable Speed ECM - Constant Airflow at rated SP
	Running Current (Rated)	A	2.4
	Power Consumption (Rated)	W	373
	HP		1/2
Blower	Dimensions (D x W)	in. (mm)	10 x 6 (254 x 152.4)
Temperature Control			Microcomputer Control
Cabinet Dimensions (H x W x D)		in. (mm)	45 x 17.7 x 21 (1143 x 450 x 533)
Ship Weight		lbs (kg)	115 (52.16)
Heat Insulation			Both Liquid and Gas Pipes
Piping Connection	Liquid	in. (mm)	ϕ 1/4 (ϕ 6.4)
	Gas	in. (mm)	ϕ 5/8 (ϕ 15.9)
	Drain	in. (mm)	ϕ 3/4 (ϕ 19)
Note			*Available in horizontal or vertical configurations. *Field-installed electric heater kit available - refer to the installation manual for available options. *A single CMXV* unit can be powered directly by the outdoor unit (OD). *For installations requiring multiple CMXV**AVJUA units connected to one OD, an alternative wiring method must be used. Refer to the wiring diagram for details.

Conversion Formulae
kcal/h = kW x 860
Btu/h = kW x 3412
cfm = m ³ /min x 35.3

1.2 Outdoor Unit

1.2.1 Standard Type

Model		2MXM18AVJU9 2MXM18AVJU8		3MXM24AVJU9 3MXM24AVJU8		
		Cooling	Heating	Cooling	Heating	
Power Supply	Phase	1 ϕ		1 ϕ		
	Hz, V	60 Hz, 208 - 230 V		60 Hz, 208 - 230 V		
COP@5°F	W/W	—	1.8 (Non-Ducted) 1.8 (Ducted)	—	1.8 (Non-Ducted) 1.76 (Ducted)	
EER2	Btu/W·h	12.0 (Non-Ducted) 10.0 (Ducted)	—	12.0 (Non-Ducted) 9.8 (Ducted)	—	
SEER2		21.0 (Non-Ducted) 16.0 (Ducted)	—	21.0 (Non-Ducted) 16.0 (Ducted)	—	
HSPF2		—	10.0 (Non-Ducted) 8.5 (Ducted)	—	10.0 (Non-Ducted) 8.5 (Ducted)	
Casing Color		Ivory White		Ivory White		
Compressor	Type	Hermetically Sealed Swing Type		Hermetically Sealed Swing Type		
	Model	2Y147BKBX1A		2Y260BPAX1A		
	Motor Output	W	1,300		2,400	
Refrigerant Oil	Model	FW68DA		FW68DA		
	Charge	fl oz (L)	22.0 (0.65)		30.4 (0.9)	
Refrigerant	Type	R-32		R-32		
	Charge	lbs (kg)	3.3 (1.50)		4.9 (2.2)	
Airflow Rates	cfm	2,112	2,140	2,055	2,140	
	m ³ /min	59.8	60.6	58.2	60.6	
Fan	Type	Propeller		Propeller		
	Motor Output	W	150		150	
	Running Current	A	0.31	0.33	0.29	0.33
	Power Consumption	W	65.4	67.7	61.0	67.7
Starting Current	A	14.0		17.0		
Dimensions (H × W × D)	in. (mm)	29-1/2 × 34-1/4 × 12-5/8 (750 × 870 × 320)		29-1/2 × 34-1/4 × 12-5/8 (750 × 870 × 320)		
Packaged Dimensions (H × W × D)	in. (mm)	32-1/16 × 40-5/16 × 16 (814 × 1,024 × 406)		32-1/16 × 40-5/16 × 16 (814 × 1,024 × 406)		
Weight (Mass)	lbs (kg)	127 (58)		140 (64)		
Gross Weight (Gross Mass)	lbs (kg)	135 (61)		148 (67)		
Sound Pressure Level	dB(A)	52	54	52	54	
Piping Connection	Liquid	in. (mm)	ϕ 1/4 × 2 (ϕ 6.4 × 2)		ϕ 1/4 × 3 (ϕ 6.4 × 3)	
	Gas	in. (mm)	ϕ 3/8 × 1, ϕ 1/2 × 1 (ϕ 9.5 × 1, ϕ 12.7 × 1)		ϕ 3/8 × 1, ϕ 1/2 × 2 (ϕ 9.5 × 1, ϕ 12.7 × 2)	
	Drain	in. (mm)	I.D. ϕ 5/8 (ϕ 15.9)		I.D. ϕ 5/8 (ϕ 15.9)	
Heat Insulation		Both Liquid and Gas Pipes		Both Liquid and Gas Pipes		
No. of Wiring Connections		3 for Power Supply, 4 for Interunit Wiring (Including Ground Wiring)		3 for Power Supply, 4 for Interunit Wiring (Including Ground Wiring)		
Max. Interunit Piping Length	ft (m)	164 (50) (for Total of Each Room)		230 (70) (for Total of Each Room)		
	ft (m)	82 (25) (for One Room)		82 (25) (for One Room)		
Amount of Additional Charge	oz/ft (g/m)	0.22 (20) (98-3/8 ft (30 m) or more)		0.22 (20) (131-1/4 ft (40 m) or more)		
Max. Installation Height Difference	ft (m)	49-1/4 (15) (Between Indoor Unit and Outdoor Unit)		49-1/4 (15) (Between Indoor Unit and Outdoor Unit)		
	ft (m)	24-5/8 (7.5) (Between Indoor Units)		24-5/8 (7.5) (Between Indoor Units)		
Conditions based on		Indoor ; 80°FDB (26.7°CDB) / 67°FWB (19.4°CWB)	Indoor ; 70°FDB (21°CDB) / 60°FWB (15.6°CWB)	Indoor ; 80°FDB (26.7°CDB) / 67°FWB (19.4°CWB)	Indoor ; 70°FDB (21°CDB) / 60°FWB (15.6°CWB)	
		Outdoor ; 95°FDB (35°CDB) / 75°FWB (24°CWB)	Outdoor ; 47°FDB (8.3°CDB) / 43°FWB (6°CWB)	Outdoor ; 95°FDB (35°CDB) / 75°FWB (24°CWB)	Outdoor ; 47°FDB (8.3°CDB) / 43°FWB (6°CWB)	
		Piping length: 25 ft (7.5 m)		Piping length: 25 ft (7.5 m)		
Drawing No.		C: 3D151521A C: 3D160891		C: 3D152057A C: 3D160892		

Conversion Formulae
kcal/h = kW × 860
Btu/h = kW × 3412
cfm = m ³ /min × 35.3

Model	4MXM36AVJU9 4MXM36AVJU8				5MXM48AVJU9 5MXM48AVJU8				
	Cooling		Heating		Cooling		Heating		
Power Supply	Phase	1 ϕ				1 ϕ			
	Hz, V	60 Hz, 208 - 230 V				60 Hz, 208 - 230 V			
COP@5°F	W/W	—		1.8 (Non-Ducted) 1.8 (Ducted)		—		1.9 (Non-Ducted) 1.76 (Ducted)	
EER2	Btu/W-h	10.0 (Non-Ducted) 8.0 (Ducted)		—		10.0 (Non-Ducted) 8.2 (Ducted)		—	
SEER2		20.0 (Non-Ducted) 15.2 (Ducted)		—		20.0 (Non-Ducted) 14.5 (Ducted)		—	
HSPF2		—		9.5 (Non-Ducted) 8.1 (Ducted)		—		9.5 (Non-Ducted) 8.2 (Ducted)	
Casing Color		Ivory White				Ivory White			
Compressor	Type	Hermetically Sealed Swing Type				Hermetically Sealed Swing Type			
	Model	2Y260BPAX1A				2Y350BPCX2A			
	Motor Output	W		2,400		3,300			
Refrigerant Oil	Model	FW68DA				FW68DE			
	Charge	fl oz (L)		30.4 (0.9)		51.4 (1.52)			
Refrigerant	Type	R-32				R-32			
	Charge	lbs (kg)		4.9 (2.2)		6.94 (3.15)			
Airflow Rates	cfm	2,402		2,518		3,137		3,137	
	m ³ /min	68.0		71.3		88.7		88.7	
Fan	Type	Propeller				Propeller			
	Motor Output	W		150		192			
	Running Current	A		0.44		0.48		0.48	
	Power Consumption	W		90.9		102.7		99.5	
Starting Current	A	18.5				27.0			
Dimensions (H x W x D)	in. (mm)	29-1/2 x 34-1/4 x 12-5/8 (750 x 870 x 320)				34-1/4 x 43-5/16 x 18-1/8 (870 x 1,100 x 460)			
Packaged Dimensions (H x W x D)	in. (mm)	32-1/16 x 40-5/16 x 16 (814 x 1,024 x 406)				39-15/16 x 46-7/8 x 21-15/16 (1,014 x 1,190 x 558)			
Weight (Mass)	lbs (kg)	142 (65)				219 (100)			
Gross Weight (Gross Mass)	lbs (kg)	150 (68)				238 (108)			
Sound Pressure Level	dB(A)	56		60		55		57	
Piping Connection	Liquid	in. (mm) ϕ 1/4 x 4 (ϕ 6.4 x 4)				ϕ 1/4 x 5 (ϕ 6.4 x 5)			
	Gas	in. (mm) ϕ 3/8 x 1, ϕ 1/2 x 2, ϕ 5/8 x 1 (ϕ 9.5 x 1, ϕ 12.7 x 2, ϕ 15.9 x 1)				ϕ 3/8 x 1, ϕ 1/2 x 2, ϕ 5/8 x 2 (ϕ 9.5 x 1, ϕ 12.7 x 2, ϕ 15.9 x 2)			
	Drain	in. (mm) I.D. ϕ 5/8 (ϕ 15.9)				I.D. ϕ 1 (ϕ 25)			
Heat Insulation		Both Liquid and Gas Pipes				Both Liquid and Gas Pipes			
No. of Wiring Connections		3 for Power Supply, 4 for Interunit Wiring (Including Ground Wiring)				3 for Power Supply, 4 for Interunit Wiring (Including Ground Wiring)			
Max. Interunit Piping Length	ft (m)	230 (70) (for Total of Each Room)				262 (80) (for Total of Each Room)			
	ft (m)	82 (25) (for One Room)				98 (30) (for One Room)			
Amount of Additional Charge	oz/ft (g/m)	0.22 (20) (131-1/4 ft (40 m) or more)				0.22 (20) (131-1/4 ft (40 m) or more)			
Max. Installation Height Difference	ft (m)	49-1/4 (15) (Between Indoor Unit and Outdoor Unit)				49-1/4 (15) (Between Indoor Unit and Outdoor Unit)			
	ft (m)	24-5/8 (7.5) (Between Indoor Units)				24-5/8 (7.5) (Between Indoor Units)			
Conditions based on		Indoor ; 80°FDB (26.7°CDB) / 67°FWB (19.4°CWB) Outdoor ; 95°FDB (35°CDB) / 75°FWB (24°CWB)		Indoor ; 70°FDB (21°CDB) / 60°FWB (15.6°CWB) Outdoor ; 47°FDB (8.3°CDB) / 43°FWB (6°CWB)		Indoor ; 80°FDB (26.7°CDB) / 67°FWB (19.4°CWB) Outdoor ; 95°FDB (35°CDB) / 75°FWB (24°CWB)		Indoor ; 70°FDB (21°CDB) / 60°FWB (15.6°CWB) Outdoor ; 47°FDB (8.3°CDB) / 43°FWB (6°CWB)	
		Piping length: 25 ft (7.5 m)				Piping length: 25 ft (7.5 m)			
Drawing No.		C: 3D151522A C: 3D160893				C: 3D158480 C: 3D160948			

Conversion Formulae
kcal/h = kW x 860
Btu/h = kW x 3412
cfm = m ³ /min x 35.3

1.2.2 Cold Climate Type

Model		2MXT18AVJU9 2MXT18AVJU8		2MXTH18AVJU9 2MXTH18AVJU8	
		Cooling	Heating	Cooling	Heating
Power Supply	Phase	1 ϕ		1 ϕ	
	Hz, V	60 Hz, 208 - 230 V		60 Hz, 208 - 230 V	
COP@5°F	W/W	—	1.8 (Non-Ducted) 1.44 (Ducted)	—	1.8 (Non-Ducted) 1.44 (Ducted)
EER2	Btu/W-h	12.0 (Non-Ducted) 10.0 (Ducted)	—	12.0 (Non-Ducted) 10.0 (Ducted)	—
SEER2		21.0 (Non-Ducted) 16.0 (Ducted)	—	21.0 (Non-Ducted) 16.0 (Ducted)	—
HSPF2		—	10.0 (Non-Ducted) 8.2 (Ducted)	—	10.0 (Non-Ducted) 8.2 (Ducted)
Casing Color		Ivory White		Ivory White	
Compressor	Type	Hermetically Sealed Swing Type		Hermetically Sealed Swing Type	
	Model	2Y260BPAX1A		2Y260BPAX1A	
	Motor Output	W	2,400	2,400	
Refrigerant Oil	Model	FW68DA		FW68DA	
	Charge	fl oz (L)	30.4 (0.9)	30.4 (0.9)	
Refrigerant	Type	R-32		R-32	
	Charge	lbs (kg)	4.9 (2.2)	4.9 (2.2)	
Airflow Rates	cfm	2,112	2,140	2,112	2,140
	m ³ /min	59.8	60.6	59.8	60.6
Fan	Type	Propeller		Propeller	
	Motor Output	W	150	150	
	Running Current	A	0.31	0.33	0.31
	Power Consumption	W	65.4	67.7	65.4
Starting Current	A	17.0		17.0	
Dimensions (H x W x D)	in. (mm)	29-1/2 x 34-1/4 x 12-5/8 (750 x 870 x 320)		29-1/2 x 34-1/4 x 12-5/8 (750 x 870 x 320)	
Packaged Dimensions (H x W x D)	in. (mm)	32-1/16 x 40-5/16 x 16 (814 x 1,024 x 406)		32-1/16 x 40-5/16 x 16 (814 x 1,024 x 406)	
Weight (Mass)	lbs (kg)	139 (63)		140 (64)	
Gross Weight (Gross Mass)	lbs (kg)	147 (67)		148 (67)	
Sound Pressure Level	dB(A)	52	54	52	54
Piping Connection	Liquid	in. (mm)	ϕ 1/4 x 2 (ϕ 6.4 x 2)		ϕ 1/4 x 2 (ϕ 6.4 x 2)
	Gas	in. (mm)	ϕ 3/8 x 1, ϕ 1/2 x 1 (ϕ 9.5 x 1, ϕ 12.7 x 1)		ϕ 3/8 x 1, ϕ 1/2 x 1 (ϕ 9.5 x 1, ϕ 12.7 x 1)
	Drain	in. (mm)	I.D. ϕ 5/8 (ϕ 15.9)		I.D. ϕ 5/8 (ϕ 15.9)
Heat Insulation		Both Liquid and Gas Pipes		Both Liquid and Gas Pipes	
No. of Wiring Connections		3 for Power Supply, 4 for Interunit Wiring (Including Ground Wiring)		3 for Power Supply, 4 for Interunit Wiring (Including Ground Wiring)	
Max. Interunit Piping Length	ft (m)	164 (50) (for Total of Each Room)		164 (50) (for Total of Each Room)	
	ft (m)	82 (25) (for One Room)		82 (25) (for One Room)	
Amount of Additional Charge	oz/ft (g/m)	0.22 (20) (98-3/8 ft (30m) or more)		0.22 (20) (98-3/8 ft (30m) or more)	
Max. Installation Height Difference	ft (m)	49-1/4 (15) (Between Indoor Unit and Outdoor Unit)		49-1/4 (15) (Between Indoor Unit and Outdoor Unit)	
	ft (m)	24-5/8 (7.5) (Between Indoor Units)		24-5/8 (7.5) (Between Indoor Units)	
Conditions based on		Indoor : 80°FDB (26.7°CDB) / 67°FWB (19.4°CWB)	Indoor : 70°FDB (21°CDB) / 60°FWB (15.6°CWB)	Indoor : 80°FDB (26.7°CDB) / 67°FWB (19.4°CWB)	Indoor : 70°FDB (21°CDB) / 60°FWB (15.6°CWB)
		Outdoor : 95°FDB (35°CDB) / 75°FWB (24°CWB)	Outdoor : 47°FDB (8.3°CDB) / 43°FWB (6°CWB)	Outdoor : 95°FDB (35°CDB) / 75°FWB (24°CWB)	Outdoor : 47°FDB (8.3°CDB) / 43°FWB (6°CWB)
Drawing No.		Piping length: 25 ft (7.5 m) C: 3D152058A C: 3D160894		Piping length: 25 ft (7.5 m) C: 3D151523A C: 3D160895	

Conversion Formulae
kcal/h = kW x 860
Btu/h = kW x 3412
cfm = m ³ /min x 35.3

Model		3MXT24AVJU9 3MXT24AVJU8		3MXTH24AVJU9 3MXTH24AVJU8		
		Cooling	Heating	Cooling	Heating	
Power Supply	Phase	1 ϕ		1 ϕ		
	Hz, V	60 Hz, 208 - 230 V		60 Hz, 208 - 230 V		
COP@5°F	W/W	—	1.9 (Non-Ducted) 1.8 (Ducted)	—	1.8 (Non-Ducted) 1.8 (Ducted)	
EER2	Btu/W·h	12.5 (Non-Ducted) 11.0 (Ducted)	—	12.5 (Non-Ducted) 11.0 (Ducted)	—	
SEER2		19.0 (Non-Ducted) 16.0 (Ducted)	—	19.0 (Non-Ducted) 16.0 (Ducted)	—	
HSPF2		—	9.5 (Non-Ducted) 8.3 (Ducted)	—	9.5 (Non-Ducted) 8.3 (Ducted)	
Casing Color		Ivory White		Ivory White		
Compressor	Type	Hermetically Sealed Swing Type		Hermetically Sealed Swing Type		
	Model	2Y350BPCX2A		2Y350BPCX2A		
	Motor Output	W	3,300	3,300	3,300	
Refrigerant Oil	Model	FW68DE		FW68DE		
	Charge	fl oz (L)	51.4 (1.52)	51.4 (1.52)	51.4 (1.52)	
Refrigerant	Type	R-32		R-32		
	Charge	lbs (kg)	6.94 (3.15)	6.94 (3.15)	6.94 (3.15)	
Airflow Rates	cfm	3,137	3,137	3,137	3,137	
	m ³ /min	88.7	88.7	88.7	88.7	
Fan	Type	Propeller		Propeller		
	Motor Output	W	192	192	192	
	Running Current	A	0.48	0.48	0.48	
	Power Consumption	W	99.5	99.5	99.5	
Starting Current	A	25.0		25.0		
Dimensions (H × W × D)	in. (mm)	34-1/4 × 43-5/16 × 18-1/8 (870 × 1,100 × 460)		34-1/4 × 43-5/16 × 18-1/8 (870 × 1,100 × 460)		
Packaged Dimensions (H × W × D)	in. (mm)	39-15/16 × 46-7/8 × 21-15/16 (1,014 × 1,190 × 558)		39-15/16 × 46-7/8 × 21-15/16 (1,014 × 1,190 × 558)		
Weight (Mass)	lbs (kg)	213 (97)		215 (97)		
Gross Weight (Gross Mass)	lbs (kg)	231 (105)		233 (106)		
Sound Pressure Level	dB(A)	55	57	55	57	
Piping Connection	Liquid	in. (mm)	ϕ 1/4 × 3 (ϕ 6.4 × 3)		ϕ 1/4 × 3 (ϕ 6.4 × 3)	
	Gas	in. (mm)	ϕ 3/8 × 1, ϕ 1/2 × 2 (ϕ 9.5 × 1, ϕ 12.7 × 2)		ϕ 3/8 × 1, ϕ 1/2 × 2 (ϕ 9.5 × 1, ϕ 12.7 × 2)	
	Drain	in. (mm)	I.D. ϕ 1 (ϕ 25)		I.D. ϕ 1 (ϕ 25)	
Heat Insulation		Both Liquid and Gas Pipes		Both Liquid and Gas Pipes		
No. of Wiring Connections		3 for Power Supply, 4 for Interunit Wiring (Including Ground Wiring)		3 for Power Supply, 4 for Interunit Wiring (Including Ground Wiring)		
Max. Interunit Piping Length	ft (m)	230 (70) (for Total of Each Room)		230 (70) (for Total of Each Room)		
	ft (m)	82 (25) (for One Room)		82 (25) (for One Room)		
Amount of Additional Charge	oz/ft (g/m)	0.22 (20) (131-1/4 ft (40 m) or more)		0.22 (20) (131-1/4 ft (40 m) or more)		
Max. Installation Height Difference	ft (m)	49-1/4 (15) (Between Indoor Unit and Outdoor Unit)		49-1/4 (15) (Between Indoor Unit and Outdoor Unit)		
	ft (m)	24-5/8 (7.5) (Between Indoor Units)		24-5/8 (7.5) (Between Indoor Units)		
Conditions based on		Indoor ; 80°FDB (26.7°CDB) / 67°FWB (19.4°CWB)	Indoor ; 70°FDB (21°CDB) / 60°FWB (15.6°CWB)	Indoor ; 80°FDB (26.7°CDB) / 67°FWB (19.4°CWB)	Indoor ; 70°FDB (21°CDB) / 60°FWB (15.6°CWB)	
		Outdoor ; 95°FDB (35°CDB) / 75°FWB (24°CWB)	Outdoor ; 47°FDB (8.3°CDB) / 43°FWB (6°CWB)	Outdoor ; 95°FDB (35°CDB) / 75°FWB (24°CWB)	Outdoor ; 47°FDB (8.3°CDB) / 43°FWB (6°CWB)	
		Piping length: 25 ft (7.5 m)		Piping length: 25 ft (7.5 m)		
Drawing No.		C: 3D158476 C: 3D160942		C: 3D158477 C: 3D160943		

Conversion Formulae

kcal/h = kW × 860
 Btu/h = kW × 3412
 cfm = m³/min × 35.3

Model		4MXT36AVJU9 4MXT36AVJU8		4MXTH36AVJU9 4MXTH36AVJU8		
		Cooling	Heating	Cooling	Heating	
Power Supply	Phase	1 ϕ		1 ϕ		
	Hz, V	60 Hz, 208 - 230 V		60 Hz, 208 - 230 V		
COP@5°F	W/W	—	1.8 (Non-Ducted) 1.8 (Ducted)	—	1.8 (Non-Ducted) 1.8 (Ducted)	
EER2	Btu/W·h	12.0 (Non-Ducted) 9.8 (Ducted)	—	12.0 (Non-Ducted) 9.8 (Ducted)	—	
SEER2		20.0 (Non-Ducted) 16.0 (Ducted)	—	20.0 (Non-Ducted) 16.0 (Ducted)	—	
HSPF2		—	9.5 (Non-Ducted) 8.6 (Ducted)	—	9.5 (Non-Ducted) 8.6 (Ducted)	
Casing Color		Ivory White		Ivory White		
Compressor	Type	Hermetically Sealed Swing Type		Hermetically Sealed Swing Type		
	Model	2Y350BPCX2A		2Y350BPCX2A		
	Motor Output	W	3,300	3,300	3,300	
Refrigerant Oil	Model	FW68DE		FW68DE		
	Charge	fl oz (L)	51.4 (1.52)	51.4 (1.52)	51.4 (1.52)	
Refrigerant	Type	R-32		R-32		
	Charge	lbs (kg)	6.94 (3.15)	6.94 (3.15)	6.94 (3.15)	
Airflow Rates	cfm	3,137	3,137	3,137	3,137	
	m ³ /min	88.7	88.7	88.7	88.7	
Fan	Type	Propeller		Propeller		
	Motor Output	W	192	192	192	
	Running Current	A	0.48	0.48	0.48	
	Power Consumption	W	99.5	99.5	99.5	
Starting Current	A	27.0		27.0		
Dimensions (H × W × D)	in. (mm)	34-1/4 × 43-5/16 × 18-1/8 (870 × 1,100 × 460)		34-1/4 × 43-5/16 × 18-1/8 (870 × 1,100 × 460)		
Packaged Dimensions (H × W × D)	in. (mm)	39-15/16 × 46-7/8 × 21-15/16 (1,014 × 1,190 × 558)		39-15/16 × 46-7/8 × 21-15/16 (1,014 × 1,190 × 558)		
Weight (Mass)	lbs (kg)	216 (98)		218 (99)		
Gross Weight (Gross Mass)	lbs (kg)	234 (106)		236 (107)		
Sound Pressure Level	dB(A)	55	57	55	57	
Piping Connection	Liquid	in. (mm)	ϕ 1/4 × 4 (ϕ 6.4 × 4)		ϕ 1/4 × 4 (ϕ 6.4 × 4)	
	Gas	in. (mm)	ϕ 3/8 × 1, ϕ 1/2 × 2, ϕ 5/8 × 1 (ϕ 9.5 × 1, ϕ 12.7 × 2, ϕ 15.9 × 1)		ϕ 3/8 × 1, ϕ 1/2 × 2, ϕ 5/8 × 1 (ϕ 9.5 × 1, ϕ 12.7 × 2, ϕ 15.9 × 1)	
	Drain	in. (mm)	I.D. ϕ 1 (ϕ 25)		I.D. ϕ 1 (ϕ 25)	
Heat Insulation		Both Liquid and Gas Pipes		Both Liquid and Gas Pipes		
No. of Wiring Connections		3 for Power Supply, 4 for Interunit Wiring (Including Ground Wiring)		3 for Power Supply, 4 for Interunit Wiring (Including Ground Wiring)		
Max. Interunit Piping Length	ft (m)	230 (70) (for Total of Each Room)		230 (70) (for Total of Each Room)		
	ft (m)	98 (30) (for One Room)		98 (30) (for One Room)		
Amount of Additional Charge	oz/ft (g/m)	0.22 (20) (131-1/4 ft (40 m) or more)		0.22 (20) (131-1/4 ft (40 m) or more)		
Max. Installation Height Difference	ft (m)	49-1/4 (15) (Between Indoor Unit and Outdoor Unit)		49-1/4 (15) (Between Indoor Unit and Outdoor Unit)		
	ft (m)	24-5/8 (7.5) (Between Indoor Units)		24-5/8 (7.5) (Between Indoor Units)		
Conditions based on		Indoor ; 80°FDB (26.7°CDB) / 67°FWB (19.4°CWB) Outdoor ; 95°FDB (35°CDB) / 75°FWB (24°CWB)	Indoor ; 70°FDB (21°CDB) / 60°FWB (15.6°CWB) Outdoor ; 47°FDB (8.3°CDB) / 43°FWB (6°CWB)	Indoor ; 80°FDB (26.7°CDB) / 67°FWB (19.4°CWB) Outdoor ; 95°FDB (35°CDB) / 75°FWB (24°CWB)	Indoor ; 70°FDB (21°CDB) / 60°FWB (15.6°CWB) Outdoor ; 47°FDB (8.3°CDB) / 43°FWB (6°CWB)	
		Piping length: 25 ft (7.5 m)		Piping length: 25 ft (7.5 m)		
Drawing No.		C: 3D158478 C: 3D160944		C: 3D158479 C: 3D160945		

Conversion Formulae
kcal/h = kW × 860
Btu/h = kW × 3412
cfm = m ³ /min × 35.3

Model		5MXT40AVJU9 5MXT40AVJU8		5MXTH40AVJU9 5MXTH40AVJU8		
		Cooling	Heating	Cooling	Heating	
Power Supply	Phase	1 ϕ		1 ϕ		
	Hz, V	60 Hz, 208 - 230 V		60 Hz, 208 - 230 V		
COP@5°F	W/W	—	1.9 (Non-Ducted) 1.8 (Ducted)	—	1.9 (Non-Ducted) 1.8 (Ducted)	
EER2	Btu/W·h	11.7 (Non-Ducted) 8.5 (Ducted)	—	11.7 (Non-Ducted) 8.5 (Ducted)	—	
SEER2		20.0 (Non-Ducted) 15.9 (Ducted)	—	20.0 (Non-Ducted) 15.9 (Ducted)	—	
HSPF2		—	9.5 (Non-Ducted) 8.2 (Ducted)	—	9.5 (Non-Ducted) 8.2 (Ducted)	
Casing Color		Ivory White		Ivory White		
Compressor	Type	Hermetically Sealed Swing Type		Hermetically Sealed Swing Type		
	Model	2Y350BPCX2A		2Y350BPCX2A		
	Motor Output	W	3,300	3,300	3,300	
Refrigerant Oil	Model	FW68DE		FW68DE		
	Charge	fl oz (L)	51.4 (1.52)	51.4 (1.52)	51.4 (1.52)	
Refrigerant	Type	R-32		R-32		
	Charge	lbs (kg)	6.94 (3.15)	6.94 (3.15)	6.94 (3.15)	
Airflow Rates	cfm	3,137	3,137	3,137	3,137	
	m ³ /min	88.7	88.7	88.7	88.7	
Fan	Type	Propeller		Propeller		
	Motor Output	W	192	192	192	
	Running Current	A	0.48	0.48	0.48	
	Power Consumption	W	99.5	99.5	99.5	
Starting Current	A	27.0		27.0		
Dimensions (H × W × D)	in. (mm)	34-1/4 × 43-5/16 × 18-1/8 (870 × 1,100 × 460)		34-1/4 × 43-5/16 × 18-1/8 (870 × 1,100 × 460)		
Packaged Dimensions (H × W × D)	in. (mm)	39-15/16 × 46-7/8 × 21-15/16 (1,014 × 1,190 × 558)		39-15/16 × 46-7/8 × 21-15/16 (1,014 × 1,190 × 558)		
Weight (Mass)	lbs (kg)	219 (100)		221 (100)		
Gross Weight (Gross Mass)	lbs (kg)	238 (108)		239 (108)		
Sound Pressure Level	dB(A)	55	57	55	57	
Piping Connection	Liquid	in. (mm)	ϕ 1/4 × 5 (ϕ 6.4 × 5)		ϕ 1/4 × 5 (ϕ 6.4 × 5)	
	Gas	in. (mm)	ϕ 3/8 × 1, ϕ 1/2 × 2, ϕ 5/8 × 2 (ϕ 9.5 × 1, ϕ 12.7 × 2, ϕ 15.9 × 2)		ϕ 3/8 × 1, ϕ 1/2 × 2, ϕ 5/8 × 2 (ϕ 9.5 × 1, ϕ 12.7 × 2, ϕ 15.9 × 2)	
	Drain	in. (mm)	I.D. ϕ 1 (ϕ 25)		I.D. ϕ 1 (ϕ 25)	
Heat Insulation		Both Liquid and Gas Pipes		Both Liquid and Gas Pipes		
No. of Wiring Connections		3 for Power Supply, 4 for Interunit Wiring (Including Ground Wiring)		3 for Power Supply, 4 for Interunit Wiring (Including Ground Wiring)		
Max. Interunit Piping Length	ft (m)	262 (80) (for Total of Each Room)		262 (80) (for Total of Each Room)		
	ft (m)	98 (30) (for One Room)		98 (30) (for One Room)		
Amount of Additional Charge	oz/ft (g/m)	0.22 (20) (131-1/4 ft (40 m) or more)		0.22 (20) (131-1/4 ft (40 m) or more)		
Max. Installation Height Difference	ft (m)	49-1/4 (15) (Between Indoor Unit and Outdoor Unit)		49-1/4 (15) (Between Indoor Unit and Outdoor Unit)		
	ft (m)	24-5/8 (7.5) (Between Indoor Units)		24-5/8 (7.5) (Between Indoor Units)		
Conditions based on		Indoor ; 80°FDB (26.7°CDB) / 67°FWB (19.4°CWB) Outdoor ; 95°FDB (35°CDB) / 75°FWB (24°CWB)	Indoor ; 70°FDB (21°CDB) / 60°FWB (15.6°CWB) Outdoor ; 47°FDB (8.3°CDB) / 43°FWB (6°CWB)	Indoor ; 80°FDB (26.7°CDB) / 67°FWB (19.4°CWB) Outdoor ; 95°FDB (35°CDB) / 75°FWB (24°CWB)	Indoor ; 70°FDB (21°CDB) / 60°FWB (15.6°CWB) Outdoor ; 47°FDB (8.3°CDB) / 43°FWB (6°CWB)	
		Piping length: 25 ft (7.5 m)		Piping length: 25 ft (7.5 m)		
Drawing No.		C: 3D158484 C: 3D160946		C: 3D158481 C: 3D160947		

Conversion Formulae
kcal/h = kW × 860
Btu/h = kW × 3412
cfm = m ³ /min × 35.3

Part 3

Printed Circuit Board

Connector Wiring Diagram

1. Indoor Unit.....	32
1.1 CTXV07AVJU9, FTXV09/12/15/18/24AVJU9	32
1.2 CDMA07AVJU9, FDMA09/12/15/18/24AVJU9	34
1.3 FVXV09/12/15/18AVJUW(T)9.....	36
1.4 CMXV12/18/24AVJUA	40
2. Outdoor Unit.....	41
2.1 2/3/4MXM, 2MXT	41
2.2 5MXM, 3/4/5MXT, 3/4/5MXTH	44

1. Indoor Unit

1.1 CTXV07AVJU9, FTXV09/12/15/18/24AVJU9

Control PCB (A1P)

- | | | |
|-----|------|--|
| 1) | S1 | Connector for terminal strip |
| 2) | S6 | Connector for swing motor (horizontal blade) |
| 3) | S91 | Connector for humidity sensor PCB (A4P) |
| 4) | S200 | Connector for DC fan motor |
| 5) | S403 | Connector for optional adaptor |
| 6) | S430 | Connector for wireless LAN connection PCB (A3P) |
| 7) | S501 | Connector for indoor heat exchanger thermistor (R1T) |
| 8) | S800 | Connector for display/signal receiver PCB (A2P) |
| 9) | FG | Connector for terminal strip (frame ground) |
| 10) | FU1 | Fuse (3.15 A, 250 V) |
| 11) | V2 | Varistor |

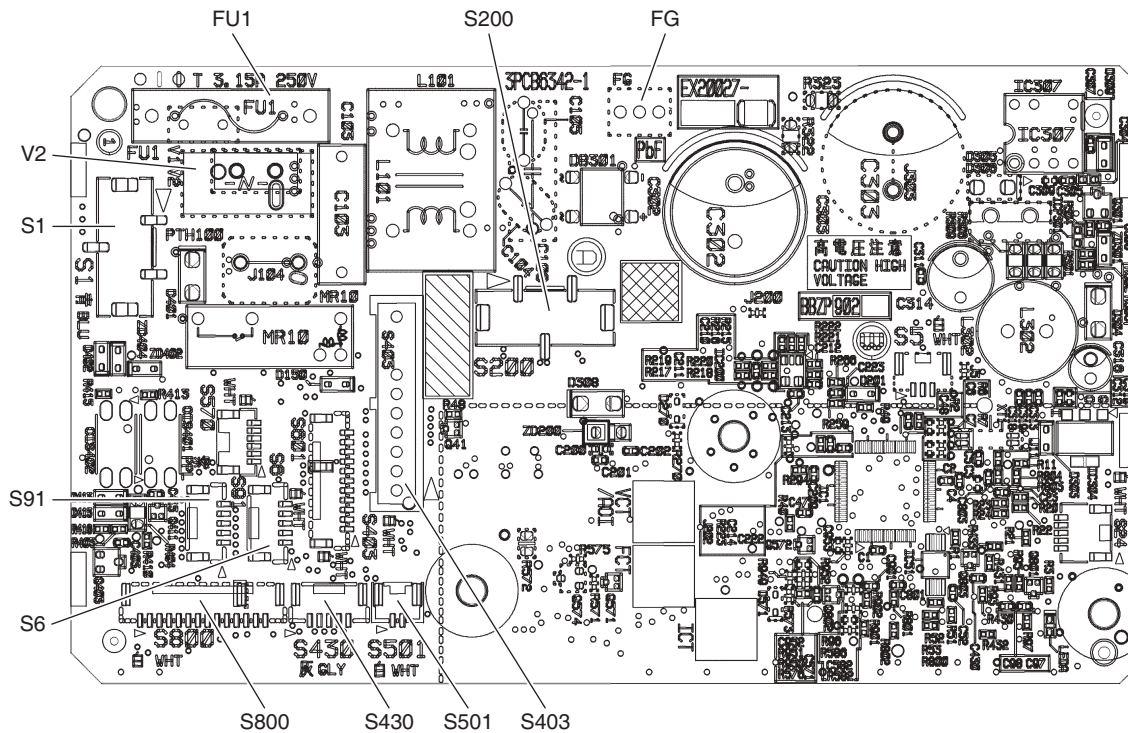

2P721387-10
2P721387-11

Display/Signal Receiver PCB (A2P)

- 1) S27 Connector for control PCB (A1P)
- 2) SW1 Indoor unit **ON/OFF** switch
(Forced cooling operation **ON/OFF** switch)
Refer to page 301 for details of forced cooling operation.
- 3) LED1 LED for operation (green)
- 4) LED2 LED for timer (orange)
- 5) LED3 LED for optional wireless LAN connection (orange)

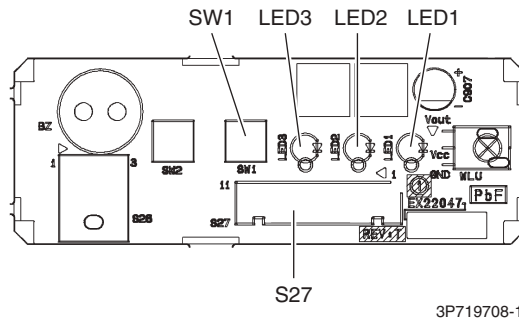

Wireless LAN connection PCB (A3P)

- 1) S90 Connector for control PCB (A1P)

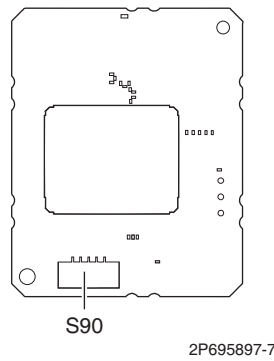

Humidity sensor PCB (A4P)

- 1) CON1 Connector for control PCB (A1P)

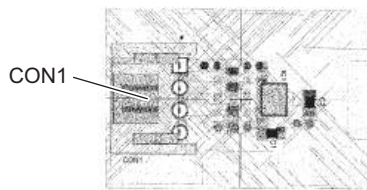

1.2 CDMA07AVJU9, FDMA09/12/15/18/24AVJU9

Control PCB (A1P)

- | | | |
|-----|------------|--|
| 1) | X15A | Connector for float switch |
| 2) | X16A | Connector for room temperature thermistor (suction air thermistor) (R1T) |
| 3) | X17A, X18A | Connector for indoor heat exchanger thermistor (R2T, R3T) |
| 4) | X25A | Connector for drain pump motor |
| 5) | X27A | Connector for terminal block (for power supply) |
| 6) | X28A | Connector for power supply wiring (option) |
| 7) | X30A | Connector for terminal block (for wired remote controller) |
| 8) | X33A | Connector for wiring (option) |
| 9) | X35A | Connector for wiring adaptor (option) |
| 10) | X41A | Connector for refrigerant sensor PCB (A3P) |
| 11) | X70A | Connector for indoor fan PCB (A2P) |
| 12) | F1U | Fuse (3.15 A, 250 V) |
| 13) | HAP | LED for service monitor (green) |
| 14) | DS1 | DIP switch for emergency |

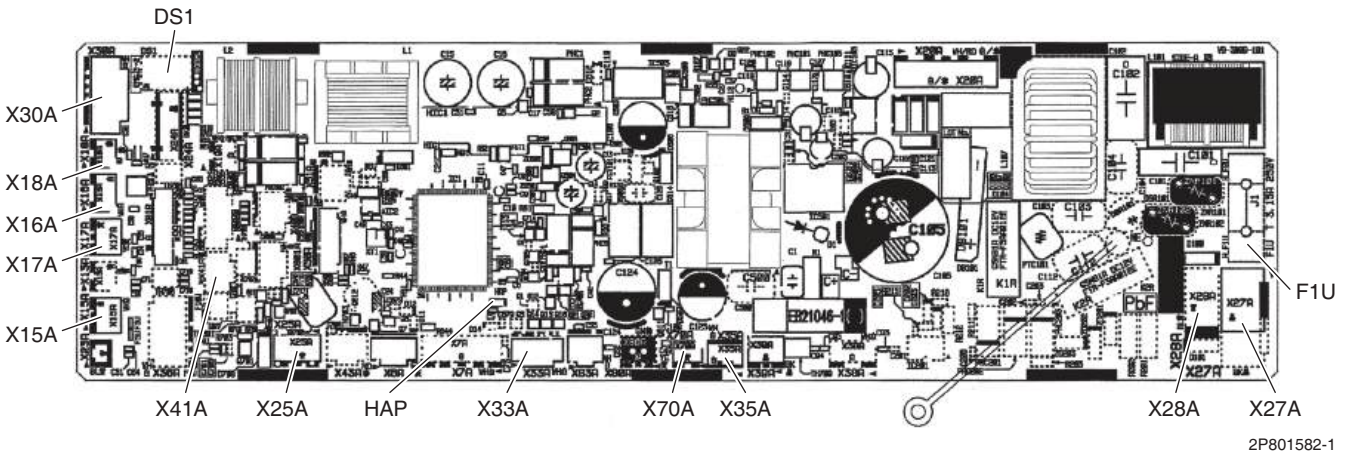

Indoor Fan PCB (A2P)

- 1) X3A Connector for control PCB (A1P)
- 2) X6A Connector for reactor
- 3) X8A Connector for DC fan motor
- 4) X10A Connector for terminal block (for power supply)
- 5) F2U Fuse (5 A, 250 V)
- 6) F4U Fuse (6.3 A, 250 V)
- 7) HAP LED for service monitor (green)

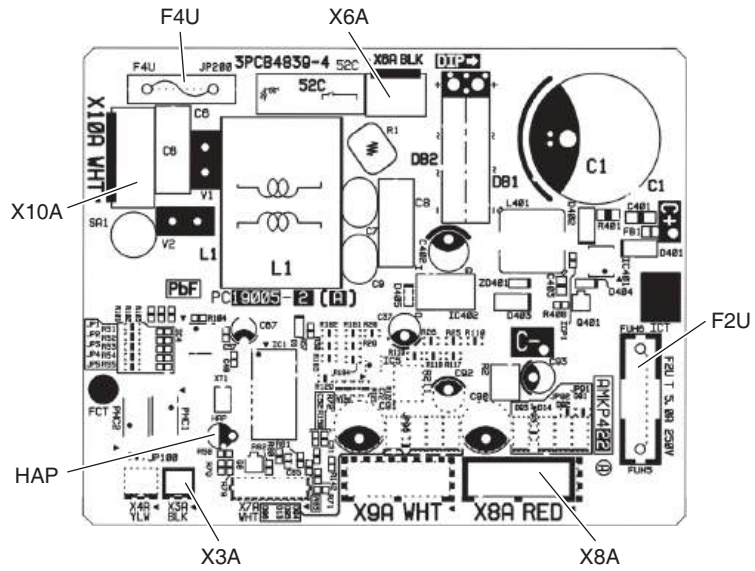

2P571965-12
2P571965-13

Refrigerant Sensor PCB (A3P)

- 1) CN1 Connector for control PCB (A1P)

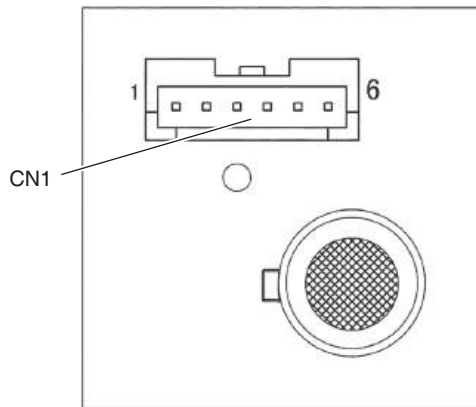

3S486006-3

1.3 FVXV09/12/15/18AVJUW(T)9

Control PCB (A1P)

- 1) X16A (S16) Connector for optional adaptor
- 2) X21A (S21) Connector for optional adaptor
- 3) X200A (S200) Connector for DC fan motor
- 4) X300A (S300A), X301A (S301B) Connector for power supply PCB (A2P)
- 5) X400A (S400), X502A (S502), X700A (S700) Connector for swing motors
- 6) X501A (S501) Connector for indoor heat exchanger thermistor (R1T)
- 7) X600A (S600) Connector for humidity sensor PCB (A5P)
- 8) X500A (S500), X800A (S800) Connector for display/signal receiver PCB (A3P)
- 9) X801A (S801) Connector for wireless LAN connection PCB (A7P)

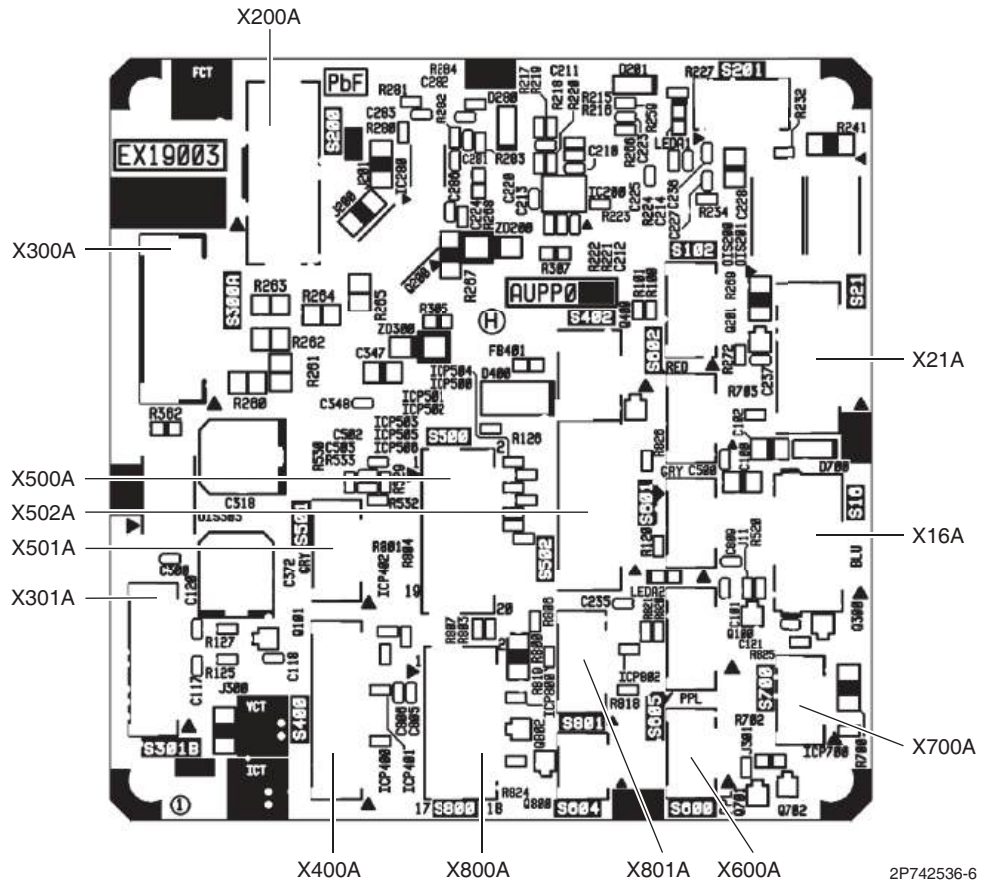

Note

The symbols in the parenthesis are the names written on the PCB.

Power Supply PCB (A2P)

- 1) X101A (S101) Connector for terminal strip (indoor-outdoor transmission)
- 2) X102A (S102), X103A (S103) Connector for control PCB (A1P)
- 3) FG Connector for terminal strip (frame ground)
- 4) F1U (FU1) Fuse (3.15 A, 250 V)
- 5) R1V (V1) Varistor

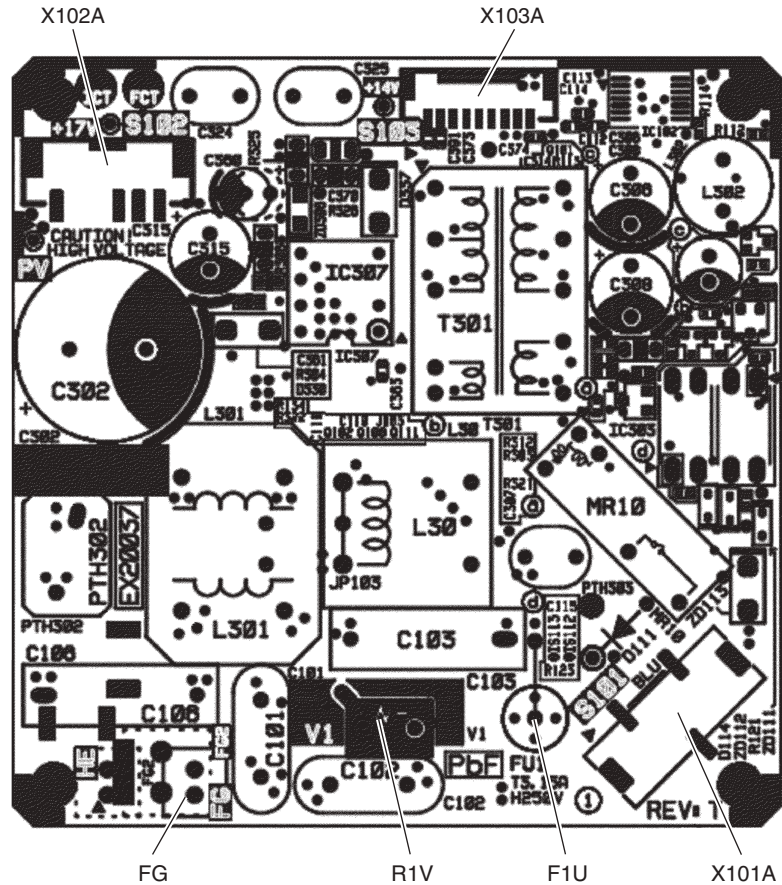

2P659905-14



Note

The symbols in the parenthesis are the names written on the PCB.

Display PCB (A3P)

- 1) X901A (S901), X902A (S902) Connector for control PCB (A1P)
- 2) X903A (S903) Connector for signal receiver PCB (A4P)
- 3) X904A (S904) Connector for refrigerant sensor PCB (A6P), indoor heat exchanger thermistor (R2T)
- 4) H1P (LED901), H2P (LED902) LED for operation lamp (multi-color)
- 5) H3P (LED903) LED for timer (orange)
- 6) H4P (LED904) LED for home leave operation (green)
- 7) H5P (LED905) LED for clean operation (green)

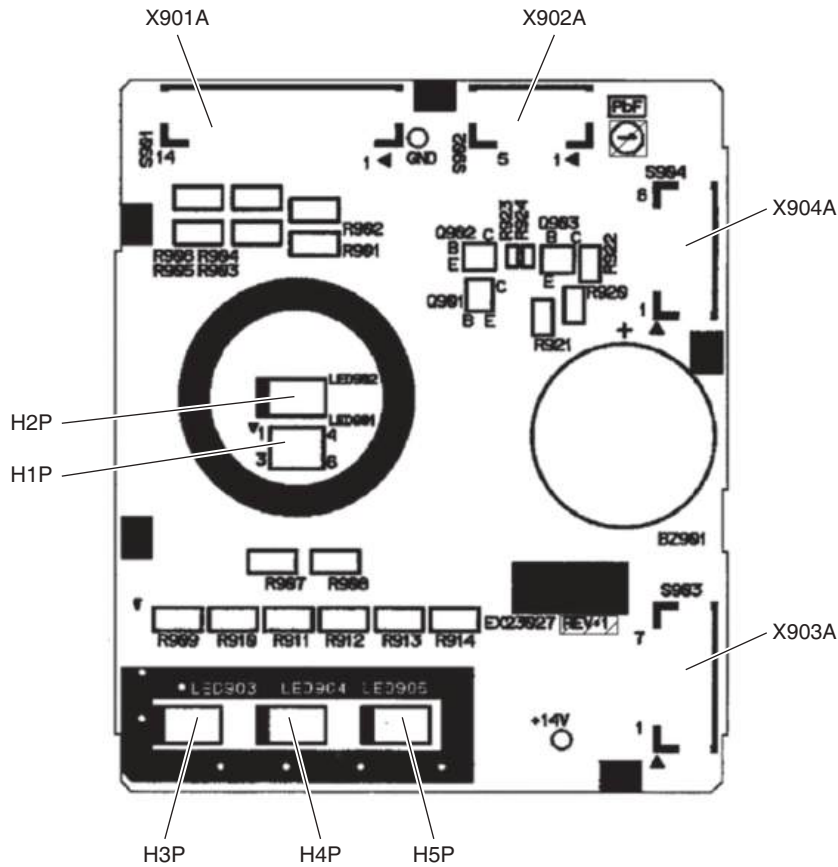

3P742526-1

Signal Receiver PCB (A4P)

- 1) X951A (S951) Connector for display PCB (A3P)
- 2) BS1 (SW951) Indoor unit **ON/OFF** switch (Forced cooling operation **ON/OFF** switch) Refer to page 301 for details of forced cooling operation.

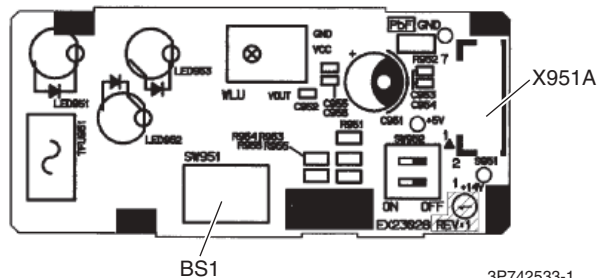

3P742533-1



The symbols in the parenthesis are the names written on the PCB.

Humidity Sensor PCB (A5P)

- 1) X80A Connector for control PCB (A1P)

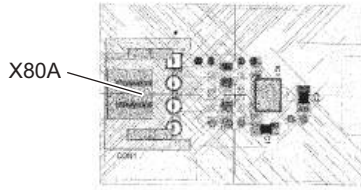

3E860031-1

Refrigerant Sensor PCB (A6P)

- 1) X70A (CN1) Connector for display PCB (A3P)

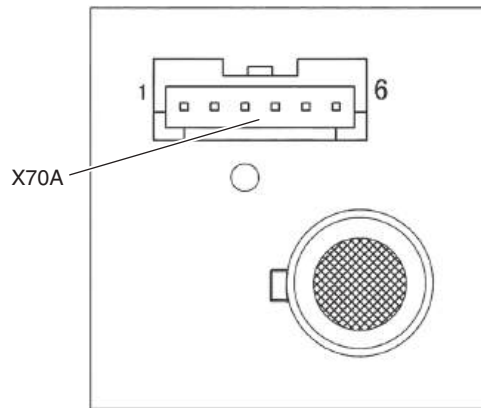

3S486006-3

Wireless LAN connection PCB (A7P)

- 1) X90A (S90) Connector for control PCB (A1P)

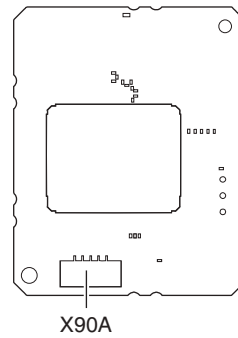

2P695897-7



Note

The symbols in the parenthesis are the names written on the PCB.

1.4 CMXV12/18/24AVJUA

Control PCB (A1P)

- | | | |
|-----|----------------|---|
| 1) | X1M | Connector for external input |
| 2) | X1A | Connector for optional heater kit |
| 3) | X5A (3, 4 pin) | Connector for liquid thermistor |
| 4) | X6A | Connector for refrigerant leak detection sensor |
| 5) | X7A | Connector for ECM motor |
| 6) | X8A | Connector for thermostat |
| 7) | X15A | Connector for low pressure sensor |
| 8) | X28A | 230 VAC output |
| 9) | S101 | 230 VAC input |
| 10) | TB3/10 | 24 VAC power input |
| 11) | TB4/5 | Auxiliary alarm terminal |
| 12) | TB6/8 | Accessory contacts |
| 13) | TB7 | Earth connection (COM) |
| 14) | TB11/12/13 | Dry contact for Leak Detection Output (Relay K6R) |
| 15) | DS1/4/5 | Dip Switch |
| 16) | DS7 | Dip switch for termination resistance |

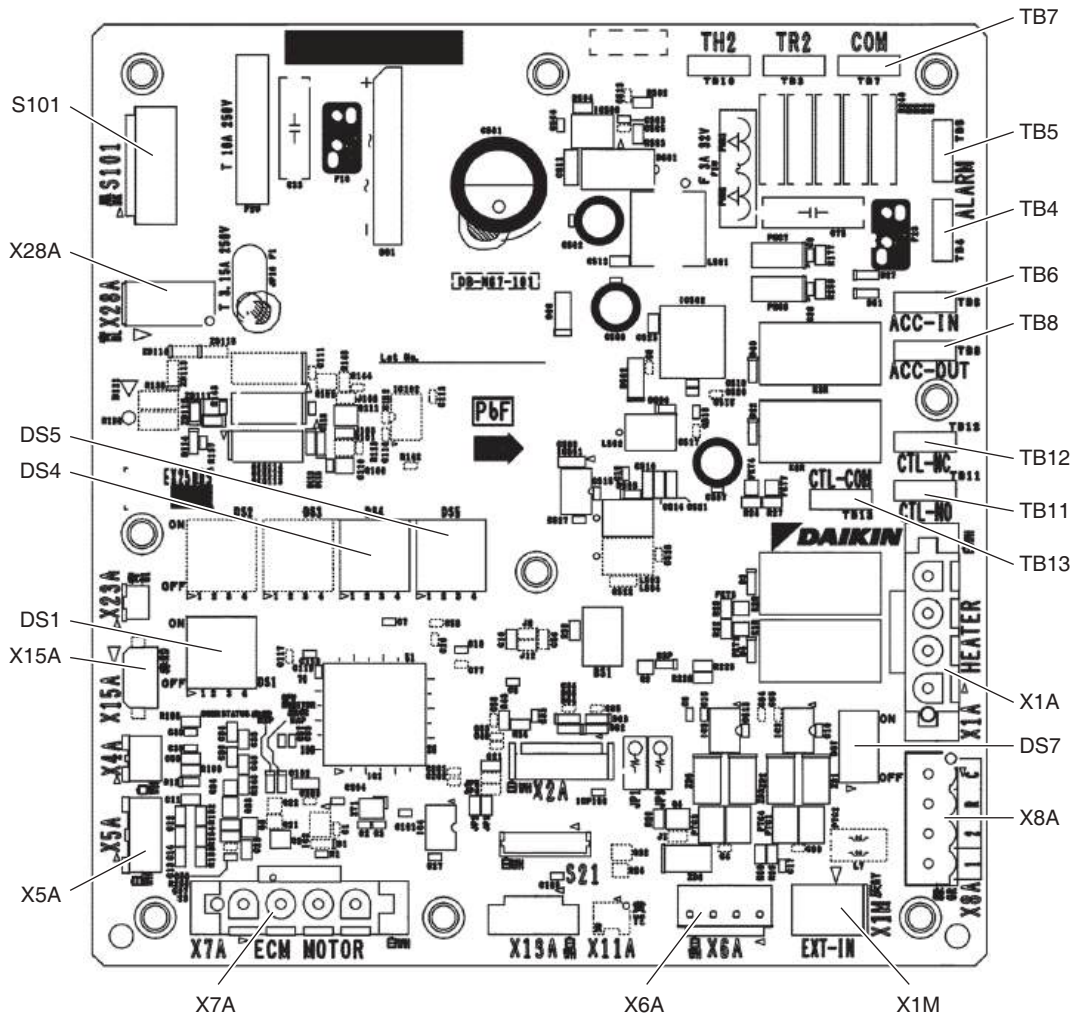

2P804911-1

2. Outdoor Unit

2.1 2/3/4MXM, 2MXT

Main PCB (A1P)

- | | | |
|-----|-------------------------|--|
| 1) | X190A | Connector for ground wire |
| 2) | X200A | Connector for DC fan motor |
| 3) | X240A, X300A,
X480A | Connector for sub PCB (A2P) |
| 4) | X800A | Connector for four way valve coil |
| 5) | X820A | Connector for overload protector and high pressure switch |
| 6) | X900A | Connector for thermistors
(outdoor temperature, outdoor heat exchanger, discharge pipe) |
| 7) | HL1, HN1 | Faston tab for terminal strip (power supply) |
| 8) | U, V, W | Faston tab for compressor |
| 9) | F1U (FU1),
F2U (FU2) | Fuse (3.15 A, 250 V) |
| 10) | F3U (FU3) | Fuse (30 A, 250 V) |

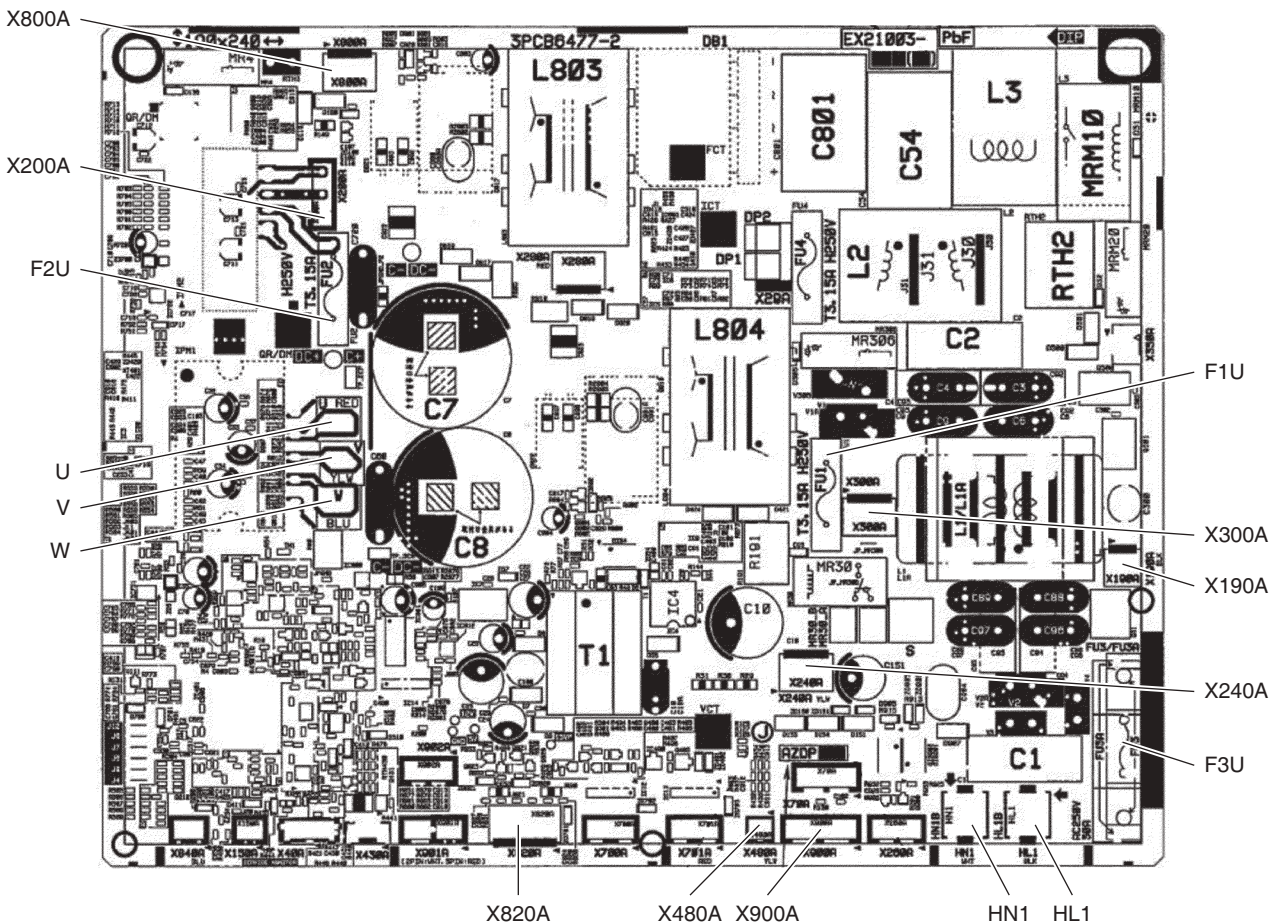

2P75473-4
2P75473-5



Note

The symbols in the parenthesis are the names on the appropriate wiring diagram.

Sub PCB (A2P)

- 1) X1A Connector for main PCB (A1P)
- 2) X141A Connector for service monitor PCB (A3P)
- 3) X161A Connector for COOL/HEAT lock
Refer to page 333 for details.
- 4) X301A Connector for terminal block (indoor - outdoor transmission)
- 5) X371A Connector for main PCB (A1P)
- 6) X621A Connector for electronic expansion valve coil A port
- 7) X622A Connector for electronic expansion valve coil B port
- 8) X623A Connector for electronic expansion valve coil C port (24/36 class)
- 9) X624A Connector for electronic expansion valve coil D port (36 class)
- 10) X931A Connector for gas pipe thermistor
- 11) X951A Connector for liquid pipe thermistor
- 12) HN1 Faston tab for main PCB (A1P)
- 13) DP3, DP4 Wire harness for drain pan heater (MXTH-A only)
- 14) F1U Fuse (3.15 A, 250 V)

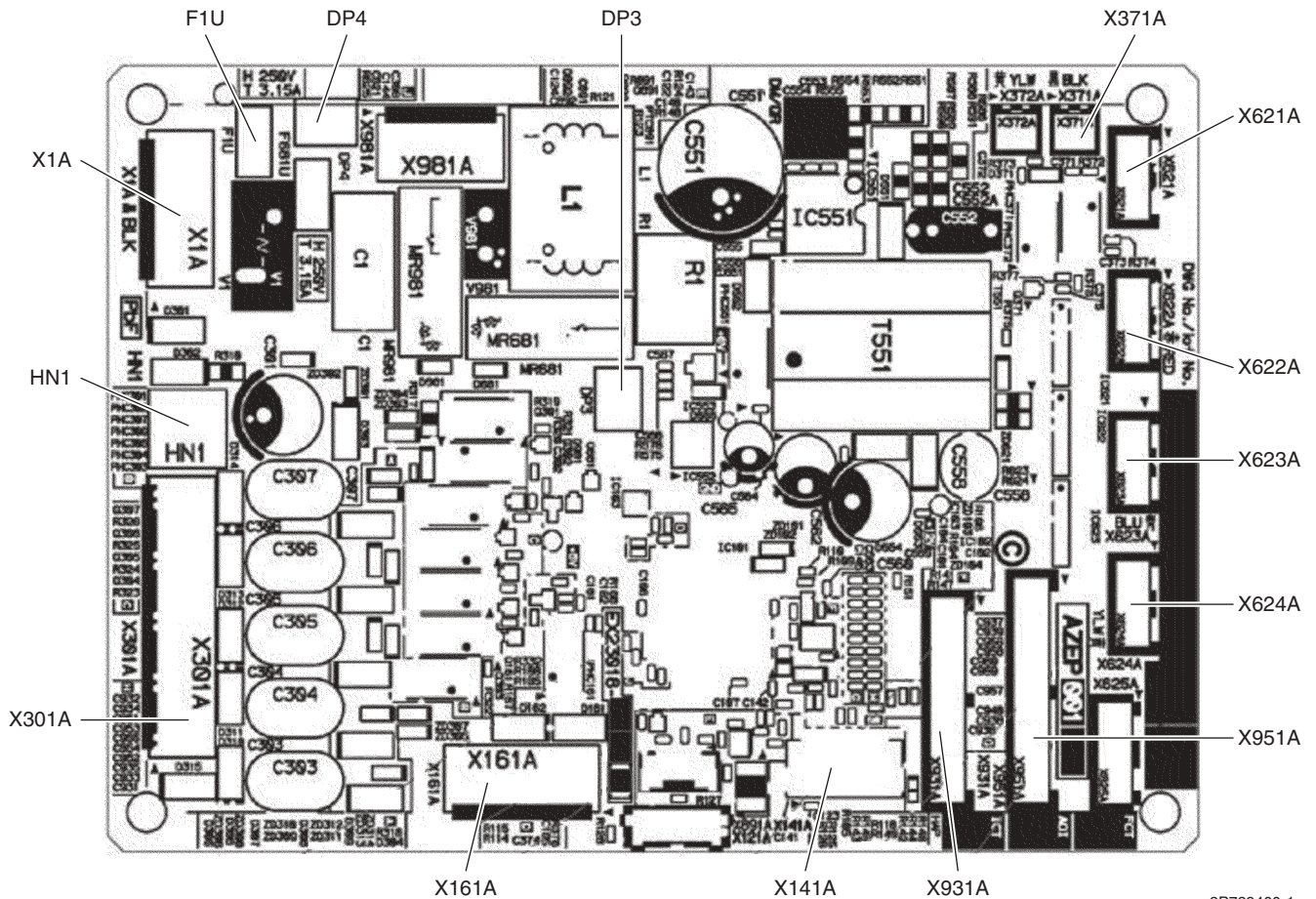

**Service Monitor
PCB (A3P)**

- | | | |
|----|------------------------------------|---|
| 1) | S501, S502 | Connector for sub PCB (A2P) |
| 2) | LED A | LED for service monitor (green) |
| 3) | LED1, LED2,
LED3, LED4,
LED5 | LED for service monitor (red) |
| 4) | SW1 | Forced cooling operation ON/OFF switch
Refer to page 301 for details. |
| 5) | SW2 | Operation mode switch
Refer to page 301 for details. |
| 6) | SW3 | Wiring error check switch
Refer to page 302 for details. |
| 7) | SW4 | Priority room setting switch
Refer to page 332 for details. |
| 8) | SW6-1 | NIGHT QUIET mode setting switch
Refer to page 334 for details. |
| 9) | J_DP | Jumper for drain pan heater |

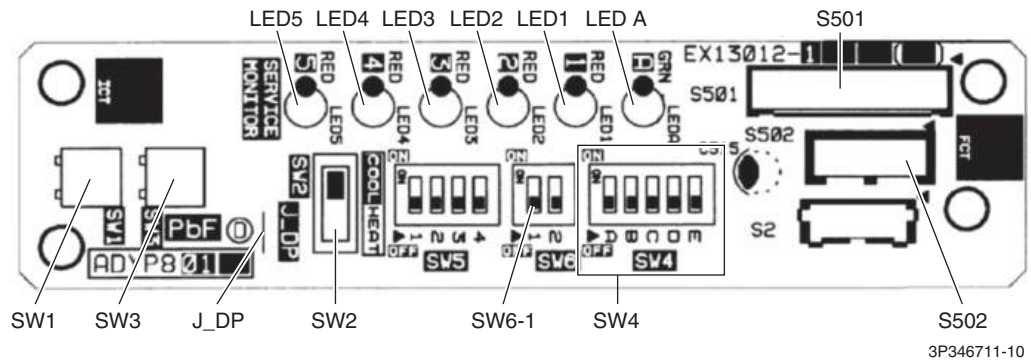

★ SW6-2 and all the switches of SW5 have no function. Keep them OFF.

2.2 5MXM, 3/4/5MXT, 3/4/5MXTH

Main PCB (A1P)

- | | | |
|-----|----------------|--|
| 1) | S, S10 | Connector for terminal block (indoor - outdoor transmission) |
| 2) | S15 | Connector for COOL/HEAT lock
Refer to page 333 for details. |
| 3) | S20 | Connector for electronic expansion valve coil A port |
| 4) | S21 | Connector for electronic expansion valve coil B port |
| 5) | S22 | Connector for electronic expansion valve coil C port
(24/36/40/48 class) |
| 6) | S23 | Connector for electronic expansion valve coil D port (36/40/48 class) |
| 7) | S24 | Connector for electronic expansion valve coil E port (40/48 class) |
| 8) | S40 | Connector for overload protector and high pressure switch |
| 9) | S60 | Connector for pressure sensor |
| 10) | S70 | Connector for DC fan motor |
| 11) | S80 | Connector for four way valve coil |
| 12) | S90 | Connector for thermistors
(outdoor temperature, outdoor heat exchanger, discharge pipe) |
| 13) | S92 | Connector for gas pipe thermistor |
| 14) | S93 | Connector for liquid pipe thermistor |
| 15) | S201, S202 | Connector for service monitor PCB (A2P) |
| 16) | DP1, DP2 | Connector for drain pan heater (MXTH-A only) |
| 17) | HL1, HN1 | Faston tab for terminal strip (power supply) |
| 18) | E1, E2, E3 | Connector for ground wire |
| 19) | W, V, U | Faston tab for compressor |
| 20) | FU1, FU2, FU10 | Fuse (3.15 A, 250 V) |
| 21) | FU3 | Fuse (30 A, 250 V) |

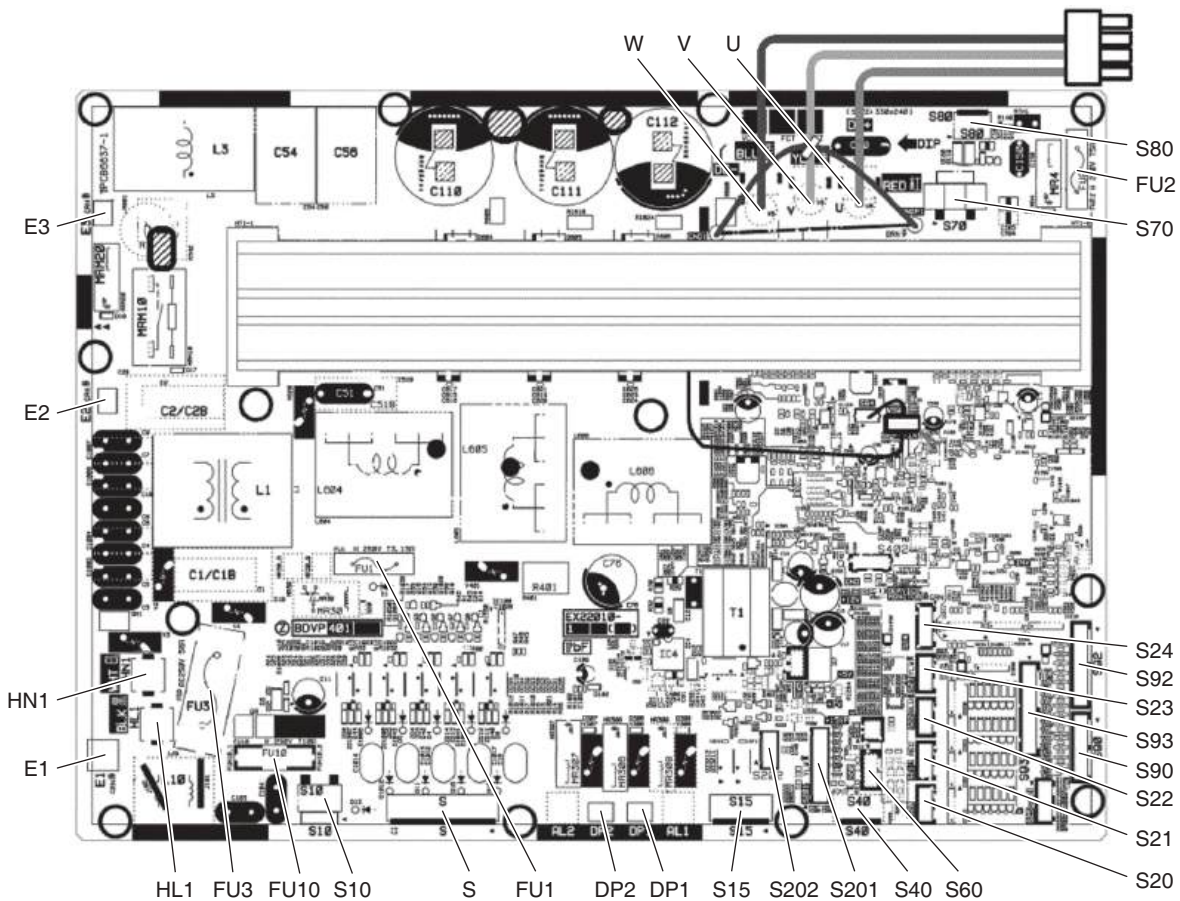

2P690309-11

Service Monitor PCB (A2P)

- 1) S501, S502 Connector for main PCB (A1P)
- 2) LED A LED for service monitor (green)
- 3) LED1, LED2, LED3, LED4, LED5 LED for service monitor (red)
- 4) SW1 Forced cooling operation **ON/OFF** switch
Refer to page 301 for details.
- 5) SW2 Operation mode switch
Refer to page 301 for details.
- 6) SW3 Wiring error check switch
Refer to page 302 for details.
- 7) SW4 Priority room setting switch
Refer to page 332 for details.
- 8) SW6-1 NIGHT QUIET mode setting switch
Refer to page 334 for details.
- 9) J_DP Jumper for drain pan heater

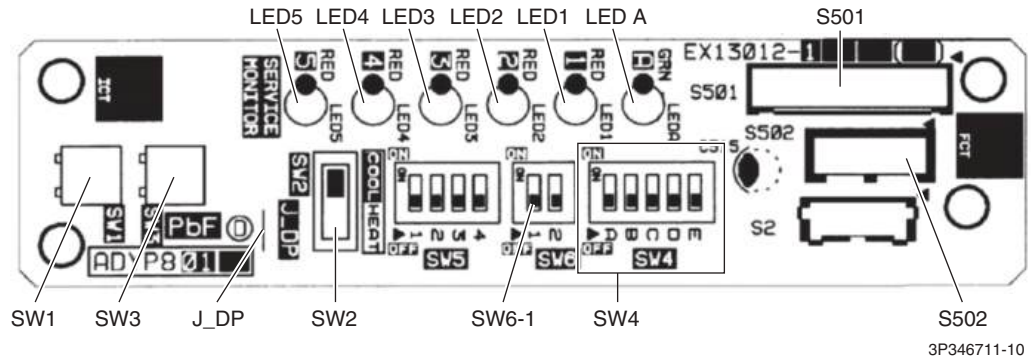

★ SW6-2 and all the switches of SW5 have no function. Keep them OFF.

Part 4

Functions and Control

1. Main Functions	48
1.1 Temperature Control	48
1.2 Frequency Principle	48
2. Functions for Wall Mounted Type	50
2.1 Airflow Direction Control	50
2.2 COMFORT AIRFLOW Operation	51
2.3 Fan Speed Control for Indoor Unit	52
2.4 Program Dry Operation	53
2.5 Automatic Cooling/Heating Change-over	54
2.6 Thermostat Control	55
2.7 NIGHT SET Mode	56
2.8 ECONO Operation	56
2.9 POWERFUL Operation	57
2.10 Brightness Setting of Indoor Unit Display	58
2.11 Wireless LAN Connection	59
2.12 Other Functions	63
3. Functions for Duct Concealed Type	64
3.1 Fan Speed Control for Indoor Unit	64
3.2 Program Dry Operation	64
3.3 Automatic Cooling/Heating Change-over	65
3.4 Clock and Calendar Setting (With BRC1NRV71)	66
3.5 Schedule Timer Operation (With BRC1NRV71)	68
3.6 Drain Pump Control	72
3.7 Hot Start Control (In Heating Operation Only)	74
3.8 Other Functions	75
4. Functions for Floor Standing Type	76
4.1 Airflow Direction Control	76
4.2 FLOOR WARMING Operation	78
4.3 Fan Speed Control for Indoor Unit	79
4.4 Program Dry Operation	80
4.5 Automatic Cooling/Heating Change-over	81
4.6 Thermostat Control	82
4.7 NIGHT SET Mode	83
4.8 ECONO Operation	83
4.9 HOME LEAVE Operation	84
4.10 POWERFUL Operation	85
4.11 HEAT PLUS Operation	86
4.12 Operation lamp (Multi-color)	87
4.13 Clock Setting	88
4.14 WEEKLY TIMER Operation	89
4.15 Brightness Setting of Indoor Unit Display	95
4.16 CLEAN Operation	96
4.17 Wireless LAN Connection	98

4.18 Other Functions.....	101
5. Functions for CMXV Series.....	102
5.1 Fan Speed Control for Indoor Unit	102
5.2 Program Dry Operation	102
5.3 Automatic Cooling/Heating Change-over	102
5.4 Refrigerant Detection System (RDS) Function.....	103
5.5 Leak Detection Output (Relay K6R).....	104
5.6 Accessory Contacts (Humidifier Relay).....	105
5.7 Electric Heater Control	106
5.8 Fan Off-delay Control	107
5.9 Auxiliary Alarm Switch.....	107
5.10 Freeze-up Protection Control	108
6. Control Specification	109
6.1 Thermistor Functions.....	109
6.2 Mode Hierarchy	111
6.3 Compressor Speed Control.....	112
6.4 Controls at Mode Changing/Start-up.....	114
6.5 Discharge Pipe Temperature Control.....	116
6.6 Input Current Control.....	117
6.7 Freeze-up Protection Control	118
6.8 Heating Peak-cut Control	119
6.9 High Pressure Protection Control.....	120
6.10 Outdoor Fan Control.....	121
6.11 Liquid Compression Protection Function.....	121
6.12 Defrost Control	121
6.13 Low Compressor Speed High Pressure Limit	128
6.14 Electronic Expansion Valve Control	129
6.15 Malfunctions	134

1. Main Functions

1.1 Temperature Control

Definitions of Temperatures

The definitions of temperatures are classified as following.

- Room temperature: temperature of lower part of the room
- Set temperature: temperature set by remote controller
- Room thermistor temperature: temperature detected by room temperature thermistor
- Target temperature: temperature determined by microcomputer

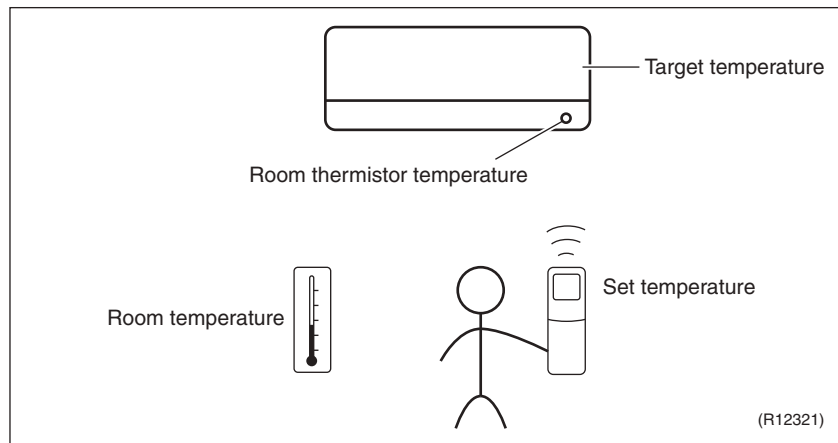

★ The illustration is for wall mounted type as representative.

Temperature Control

The temperature of the room is detected by the room temperature thermistor. However, there is a difference between the temperature detected by room temperature thermistor and the temperature of lower part of the room, depending on the type of the indoor unit or installation condition. In practice, the temperature control is done by the target temperature appropriately adjusted for the indoor unit and the temperature detected by room temperature thermistor.

1.2 Frequency Principle

Control Parameters

The compressor speed is controlled by the following 2 parameters:

- The load condition of the operating indoor unit
- The difference between the room thermistor temperature and the target temperature

The target compressor speed is adapted by additional parameters in the following cases:

- Compressor speed restrictions
- Initial settings
- Forced cooling operation

Inverter Principle

To regulate the capacity, a compressor speed control is needed. The inverter makes it possible to control the rotation speed of the compressor. The followings explain the inverter principle:

Phase 1

The supplied AC power source is converted into the DC power source for the present.

Phase 2

The DC power source is reconverted into the three phase AC power source with variable frequency.

- When the frequency increases, the rotation speed of the compressor increases resulting in an increase of refrigerant circulation. This leads to a larger amount of heat exchange per unit.

- When the frequency decreases, the rotation speed of the compressor decreases resulting in a decrease of refrigerant circulation. This leads to a smaller amount of heat exchange per unit.

The following drawing shows a schematic view of the inverter principle:

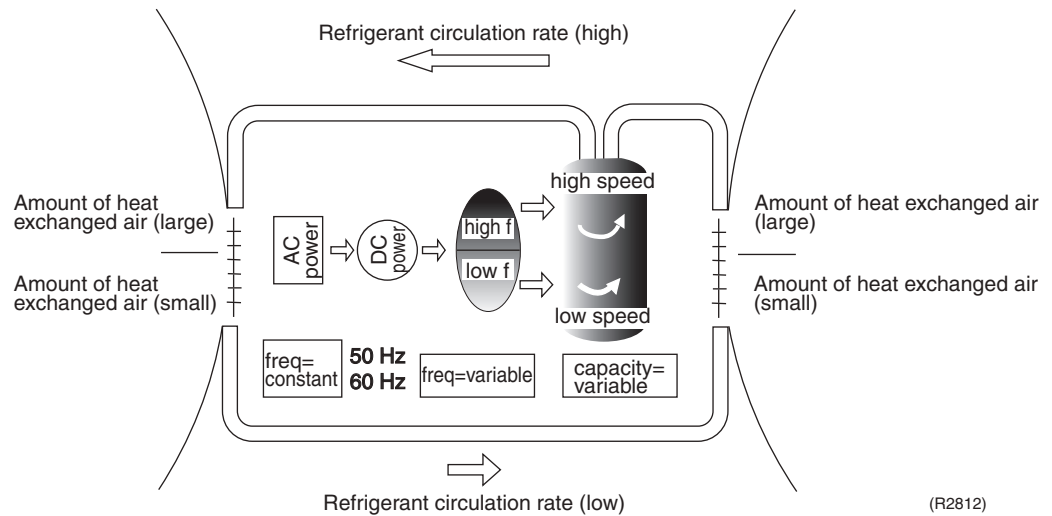

Inverter Features

The inverter provides the following features:

- The regulating capacity can be changed according to the changes in the outdoor temperature and cooling/heating load.
- Quick heating and quick cooling
The rotation speed of the compressor is increased when starting the heating (cooling). This enables to reach the set temperature quickly.
- Even during extreme cold weather, high capacity is achieved. It is maintained even when the outdoor temperature is 2°C (35.6°F).
- Comfortable air conditioning
A fine adjustment is integrated to keep the room temperature constant.
- Energy saving heating and cooling
Once the set temperature is reached, the energy saving operation enables to maintain the room temperature at low power.

Compressor Speed Limits

The following functions regulate maximum compressor speed:

Low compressor speed

- Four way valve operation compensation. Refer to page 114.

High compressor speed

- Compressor protection function. Refer to page 115.
- Discharge pipe temperature control. Refer to page 116.
- Input current control. Refer to page 117.
- Freeze-up protection control. Refer to page 118.
- Heating peak-cut control. Refer to page 119.
- Defrost control. Refer to page 121.

Forced Cooling Operation

Refer to page 301 for details.

2. Functions for Wall Mounted Type

2.1 Airflow Direction Control

Power-Airflow (Dual) Flap(s)

The large flap sends a large volume of air downward to the floor and provides an optimum control in cooling, dry and heating operation.

Cooling/Dry

During cooling or dry operation, the flap retracts into the indoor unit. Then, cool air can be blown far and distributed all over the room.

Heating

During heating operation, the large flap directs airflow downward to spread the warm air to the entire room.

Wide-Angle Louvers

The louvers, made of elastic synthetic resin, provide a wide range of airflow that guarantees comfortable air distribution.

Auto-Swing

The following tables explain the auto-swing process for cooling, dry, heating and fan:

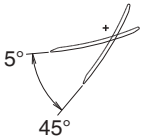
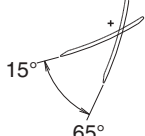
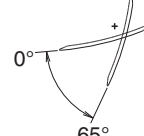
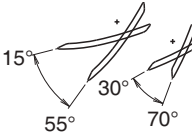
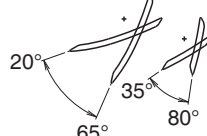
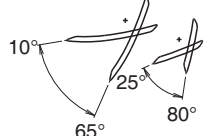
	Flap (up and down)		
	Cooling/Dry	Heating	Fan
07/09/12 class	 R4004115	 (R21049)	 (R21050)
15/18/24 class	 R4004124	 R4004125	 R4004126

2.2 COMFORT AIRFLOW Operation

Outline

The flow of air will be in the upward direction while in COOL/DRY operation and in the downward direction while in HEAT operation, which will provide a comfortable wind that will not come in direct contact with people.

Operation



To start the operation:

- Press **Comfort** button.

The icon appears on the LCD of the remote controller.

	COOL / DRY operation	HEAT operation	FAN operation
Flaps direction	Goes up	Goes down	Not available
Airflow rate	AUTO		

To stop the operation:

- Press **Comfort** button again.

The icon disappears from the LCD of the remote controller. The flaps will return to the memorized position before the start of COMFORT AIRFLOW operation



Note(s)

- POWERFUL operation and COMFORT AIRFLOW operation cannot be used at the same time.
- When in AUTO operation, the flap direction differs based on the operation mode (COOL or HEAT) as shown in the table above.
- If the upward and downward airflow direction is selected, the COMFORT AIRFLOW function will be canceled. Priority is given to the function of whichever button is pressed last.

2.3 Fan Speed Control for Indoor Unit

Outline

Phase control and fan speed control contains 9 steps: LLL, LL, SL, L, ML, M, MH, H, and HH. The airflow rate can be automatically controlled depending on the difference between the room thermistor temperature and the target temperature.

Automatic Fan Speed Control

In automatic fan speed operation, the step SL is not available.

Step	Cooling	Heating
LLL	↕	↕
LL		
L		
ML		
M		
MH		
H		
HH (POWERFUL)		

↕ = The airflow rate is automatically controlled within this range when **FAN** setting button is set to automatic. R4003512

■ Cooling

The following drawing explains the principle of fan speed control for cooling.

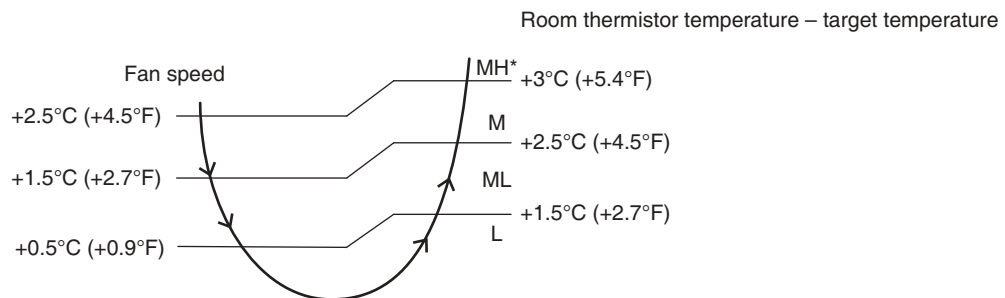

* The upper limit is at M tap in 30 minutes from the operation start. R4004133

■ Heating

In heating operation, the fan speed is regulated according to the indoor heat exchanger temperature and the difference between the room thermistor temperature and the target temperature.



Note(s)

The fan stops during defrost operation.

2.4 Program Dry Operation

Outline

Program dry operation removes humidity while preventing the room temperature from lowering. Since the microcomputer controls both the temperature and airflow rate, the temperature adjustment and **FAN** setting buttons are inoperable.

Details

The microcomputer automatically sets the temperature and airflow rate. The difference between the room thermistor temperature at start-up and the target temperature is divided into two zones. Then, the unit operates in an appropriate capacity for each zone to maintain the temperature and humidity at a comfortable level.

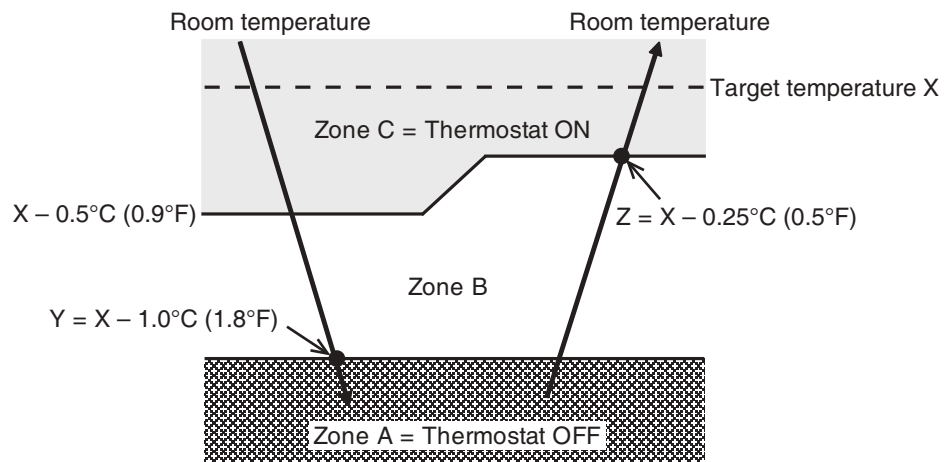

R4004134

Room thermistor temperature at start-up	Target temperature X	Thermostat OFF point Y	Thermostat ON point Z ★
24°C or more (75.2°F or more)	Room thermistor temperature at start-up	$X - 1.0^{\circ}\text{C}$ ($X - 1.8^{\circ}\text{F}$)	$X - 0.25^{\circ}\text{C}$ ($X - 0.5^{\circ}\text{F}$)
18 ~ 23.5°C (64.4 ~ 74.3°F)		$X - 0.75^{\circ}\text{C}$ ($X - 1.4^{\circ}\text{F}$)	$X - 0.25^{\circ}\text{C}$ ($X - 0.5^{\circ}\text{F}$)
17.5°C or less (63.5°F or less)	18°C (64.4°F)	$X - 0.75^{\circ}\text{C}$ ($X - 1.4^{\circ}\text{F}$)	$X - 0.25^{\circ}\text{C} = 17.75^{\circ}\text{C}$ ($X - 0.5^{\circ}\text{F} = 63.9^{\circ}\text{F}$)

★ Thermostat turns on also when the room temperature is in the zone B for 10 minutes.

2.5 Automatic Cooling/Heating Change-over

Outline

When the automatic operation is selected with the remote controller, the microcomputer automatically determines the operation mode as cooling or heating according to the room temperature and the set temperature at start-up.
The unit automatically switches the operation mode to maintain the room temperature at the set temperature.

Details

Ts: set temperature (set by remote controller)
Tt: target temperature (determined by microcomputer)
Tr: room thermistor temperature (detected by room temperature thermistor)
C: correction value

- The set temperature (Ts) determines the target temperature (Tt).
(Ts = 18 ~ 30°C (64.4 ~ 86°F))
- The target temperature (Tt) is calculated as;
 $Tt = Ts + C$
where C is the correction value.
C = 0°C (0°F)
- Thermostat ON/OFF point and operation mode switching point are as follows.
 - Heating → Cooling switching point:
 $Tr \geq Tt + 3.0^{\circ}\text{C} (+ 5.4^{\circ}\text{F})$
 - Cooling → Heating switching point:
 $Tr < Tt - 2.5^{\circ}\text{C} (- 4.5^{\circ}\text{F})$
 - Thermostat ON/OFF point is the same as the ON/OFF point of cooling or heating operation.
- During initial operation
 $Tr \geq Ts$: Cooling operation
 $Tr < Ts$: Heating operation

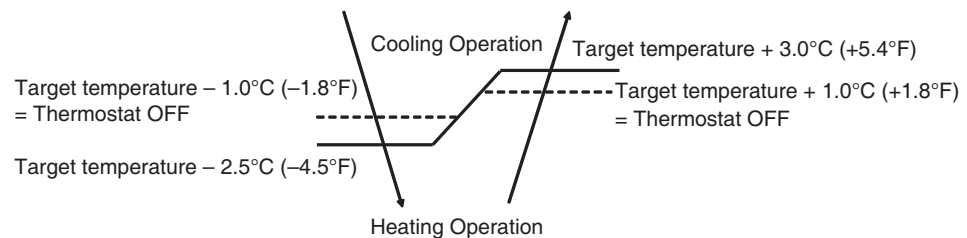

R4004135

Ex: When the target temperature is 25°C (77°F)
Cooling → 24°C (75.2°F): Thermostat OFF → 22.5°C (72.5°F): Switch to heating
Heating → 26°C (78.8°F): Thermostat OFF → 28°C (82.4°F): Switch to cooling

2.6 Thermostat Control

Outline Thermostat control is based on the difference between the room thermistor temperature and the target temperature.

Details

Thermostat OFF Conditions

- The temperature difference is in the zone A.

Thermostat ON Conditions

- The temperature difference returns to the zone C after being in the zone A.
- The system resumes from defrost control in any zones except A.
- The operation turns on in any zones except A.
- The monitoring time has passed while the temperature difference is in the zone B.

Cooling	Dry	Heating
10 minutes	7.5 minutes	180 seconds

Cooling/Dry

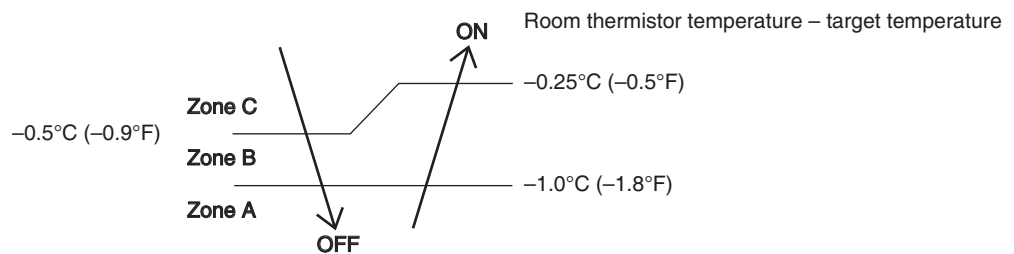

R4004136

Heating

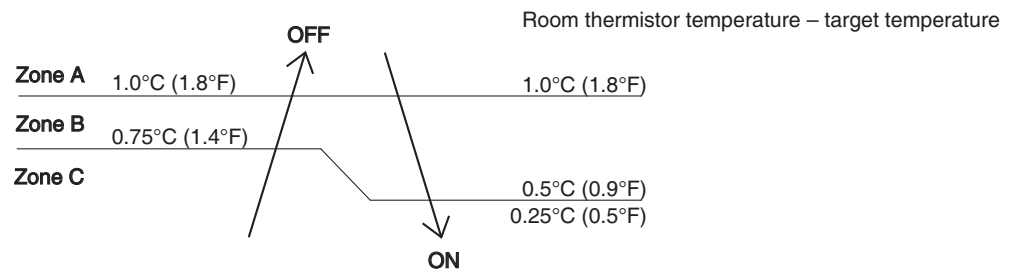

R4004137



Reference

Refer to Temperature Control on page 48 for details.

2.7 NIGHT SET Mode

Outline When the OFF TIMER is set, NIGHT SET mode is automatically activated. NIGHT SET mode keeps the airflow rate setting.

Details NIGHT SET mode continues operation at the target temperature for the first one hour, then automatically raises the target temperature slightly in the case of cooling, or lowers the target temperature slightly in the case of heating. This prevents excessive cooling in summer and excessive heating in winter to ensure comfortable sleeping conditions, and also conserves electricity.

Cooling

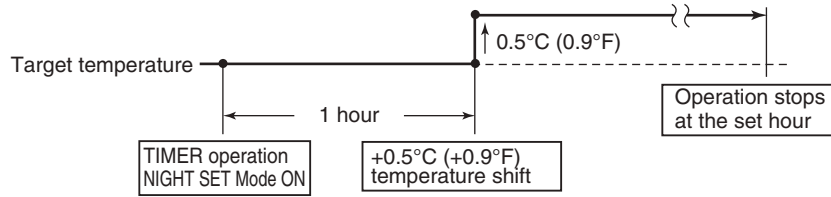

(R23917)

Heating

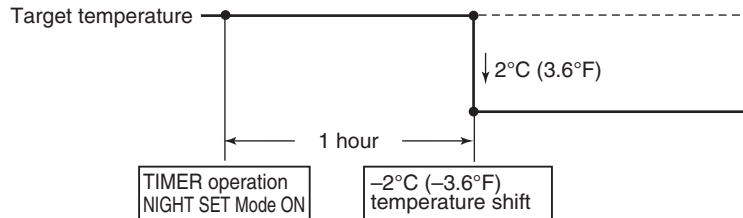

(R23918)

2.8 ECONO Operation

Outline ECONO operation reduces the maximum operating current and the power consumption. This operation is particularly convenient for energy-saving. It is also a major bonus when breaker capacity does not allow the use of multiple electrical devices and air conditioners. It can be easily activated by pressing **ECONO** button on the wireless remote controller.

- Details**
- When this function is activated, the maximum capacity also decreases.
 - The remote controller can send the ECONO command when the unit is in cooling, heating, dry, or automatic operation. This function can only be set when the unit is running. Pressing **ECONO** button on the remote controller cancels the function.
 - This function and POWERFUL operation cannot be used at the same time. The latest command has the priority.

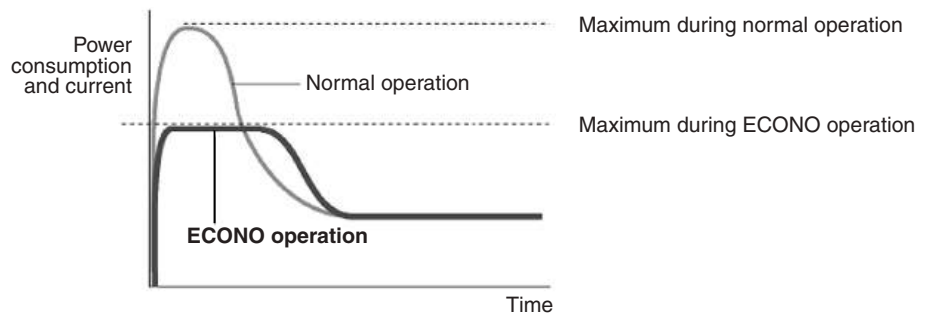

(R22012)

2.9 POWERFUL Operation

Outline

In order to exploit the cooling and heating capacity to full extent, the air conditioner can be operated by increasing the indoor fan rotating speed and the compressor speed.

Details

When **POWERFUL** button is pressed, the fan speed and target temperature are converted to the following states for 20 minutes.

Operation mode	Fan speed	Target temperature
COOL	H tap + A rpm	18°C (64.4°F)
DRY	Dry rotating speed + A rpm	Lowered by 2.5°C (4.5°F)
HEAT	H tap + A rpm	31°C (87.8°F)
FAN	H tap + A rpm	—
AUTO	Same as cooling/heating in POWERFUL operation	The target temperature is kept unchanged.

A = 40 ~ 80 rpm (depending on the model)

Ex: POWERFUL operation in cooling

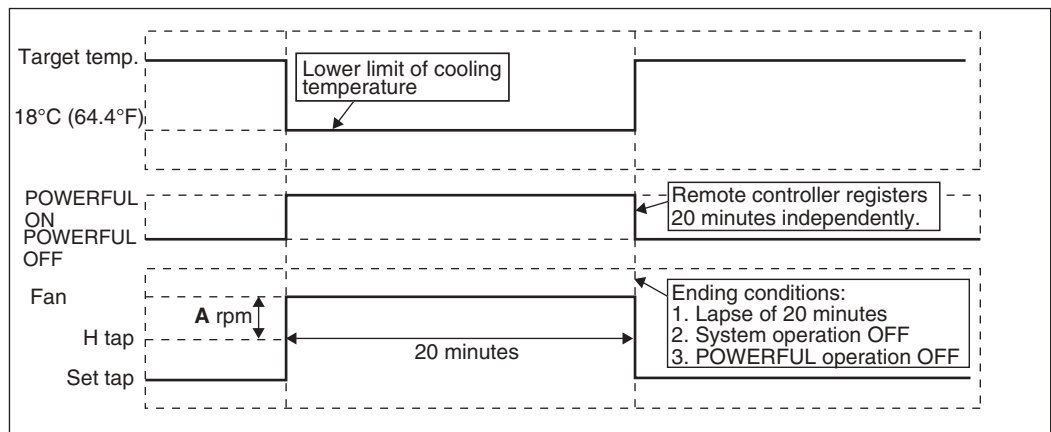

(R24589)



Note(s)

- During POWERFUL operation, the cooling/heating efficiency of the other rooms may be slightly reduced.
- POWERFUL operation cannot be used together with ECONO, COMFORT AIRFLOW or OUTDOOR UNIT QUIET operation.

2.10 Brightness Setting of Indoor Unit Display

Outline

The brightness of the indoor unit display can be adjusted as desired. Also, the display can be turned OFF.

Details

1. Press and hold **FAN** button for 5 seconds.
2. Press **TEMP ▲** button to select menu number 1.
LED appears and 1 blinks.

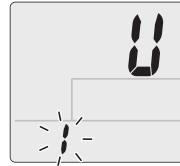

3. Press **FAN** button to confirm the select setting.
4. Press **TEMP ▲** or **TEMP ▼** button to change the setting as follows:

R4004121

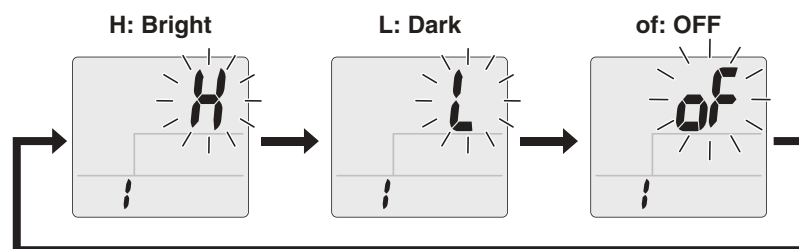

R4004122

5. Press **FAN** button again. Brightness will be set to the chosen value.
6. Press and hold **FAN** button for 5 seconds to return to the default screen.



Note(s)

The display automatically returns to the default screen after 60 seconds. To return to the default screen sooner, press **CANCEL** button twice.

2.11 Wireless LAN Connection

Operation

Wireless LAN connection adapter

The Wireless LAN connection adapter function requires the Daikin One Home for connecting to the air conditioner and controlling it via your smartphone or tablet over your network.

Attention

- **Wireless LAN sends and receives data using radio waves so there is a risk of transmitted data being subject to eavesdropping and illegal access. When using wireless LAN, manage the SSID/KEY of the wireless LAN connection adapter, the SSID/KEY of the wireless router, and the app login information so that they will not be known to others, and ensure that you have an adequate understanding of the risks involved. In the case that the product is accessed and operated illegally, turn off the wireless LAN connection adapter function.**
- **Do not use this product near a microwave oven. (This can affect wireless LAN communications.)**
- **This product cannot be directly connected to the communication line of a telecommunications carrier (internet service provider, etc.). When connecting to the internet, be sure to connect via a device such as a router.**

When the wireless LAN connection adapter function is turned on, the right side of the air conditioner may become slightly warm, but this is not an abnormality.

WARNING

- While the Wireless LAN connection adapter operates, it may affect persons using cardiac pacemakers or defibrillators. This product may cause electromagnetic interference.
- While the Wireless LAN connection adapter operates, it may affect automatic doors or fire alarm equipment. This product may cause faulty behavior of the equipment.

Configuration

- The user is responsible for providing the following items before using this product:
 - Smartphone or tablet PC
 - Internet line and communicating device (Modem/router or similar device)
 - Wireless LAN access point
 - Application name: [Daikin One Home] (free)
- For details on the installation method for the Daikin One Home.

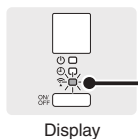

Wireless LAN connection adapter lamp (Orange)

- The Wireless LAN connection adapter lamp lights when connecting to a router (Wireless LAN access point).
- For Wireless LAN connection adapter operation.

WARNING

When operating an air conditioner from outside the home, it is not possible to check the air conditioner or the surroundings of the air conditioner, or the state of the people in the room. Therefore, make sure to adequately check for safety before use.

In some cases, there is a risk of death, severe injury, or property damage.

- **Check the following in advance (while at home)**
 - Timer settings or reservations that other users may have made. (There is a risk of causing harm to the health of people, animals, or plants in the home if operation starts and stops unexpectedly)
 - There are no signs of abnormality in the air conditioning. Harm will not be caused to people or to the room if there is a change in airflow. (For example, that there are no objects nearby that might blow over) (There is a risk of objects falling due to airflow and causing fire, bodily injury, or staining of household items)
 - **Check the following before/while operating a unit from outside the home**
 - If you know that there is someone at home, inform the person when turning the air conditioner on or off from outside the home. (If someone at home is standing on something such as a stool, the air conditioner turning on or off unexpectedly could surprise them and cause them to fall or topple over. Additionally, a sudden change in the indoor/outdoor temperature could harm the health of people at home)
 - The air conditioner can be turned off and temperature adjustment can be made using a remote controller in the home.
 - Do not use the function if the only people at home are persons who are unable to make adjustments to temperature or other settings themselves, such as young children, disabled persons, or elderly persons.
 - Regularly check the settings and operating status of the air conditioner. (Sudden changes in indoor/outdoor temperature pose a health hazard. There is a risk of harm to animals and plants)
- If an error occurs during operation, immediately turn off the air conditioner and contact your dealer.
Double check the display to confirm that the power is off.

Wireless LAN connection

Web site: <https://daikinone.com/ductless>

For instructions on how to connect your unit to wireless LAN and to your Daikin One Home application, please see the website above.

Contains FCC ID: VPYLB1YA

This device complies with part 15 of the FCC Rules. Operation is subject to the following two conditions:

- (1) This device may not cause harmful interference, and
- (2) This device must accept any interference received, including interference that may cause undesired operation.

FCC CAUTION

Changes or modifications not expressly approved by the party responsible for compliance could void the user's authority to operate the equipment. This transmitter must not be co-located or operated in conjunction with any other antenna or transmitter.

Contains IC: 772C-LB1YA

This device complies with Industry Canada's applicable licence-exempt RSSs.

Operation is subject to the following two conditions:

- (1) This device may not cause interference; and
- (2) This device must accept any interference, including interference that may cause undesired operation of the device.

This equipment complies with IC radiation exposure limits set forth for an uncontrolled environment and meets RSS-102 of the IC radio frequency (RF) Exposure rules. This equipment should be installed and operated keeping the radiator at least 7-7/8 inches (20cm) or more away from person's body.

The FCC responsible party is Daikin Comfort Technologies Manufacturing, L.P., and may be contacted by calling (713)-861-2500, or at 19001 Kermier Rd., Waller, TX 77484.

(<https://www.northamerica-daikin.com>)

This device, which was assembled by Daikin Comfort Technologies Manufacturing, L.P., contains a component that is classified as an intentional radiator.

This intentional radiator has been certified by the FCC: FCC ID VPYLB1YA.

And this intentional radiator has an industry Canada ID: IC 772C-LB1YA.

The manufacturer of the intentional radiator (model no. Type1YA) is Murata Manufacturing co., Ltd (www.murata.com).

This equipment complies with FCC radiation exposure limits set forth for an uncontrolled environment and meets the FCC radio frequency (RF) Exposure Guidelines. This equipment should be installed and operated keeping the radiator at least 7-7/8 inches (20cm) or more away from person's body.

Changes or modifications not expressly approved by the party responsible for compliance could void the user's authority to operate the equipment.

NOTE: This equipment has been tested and found to comply with the limits for a Class B digital device, pursuant to part 15 of the FCC Rules. These limits are designed to provide reasonable protection against harmful interference in a residential installation. This equipment generates, uses and can radiate radio frequency energy and, if not installed and used in accordance with the instructions, may cause harmful interference to radio communications. However, there is no guarantee that interference will not occur in a particular installation. If this equipment does cause harmful interference to radio or television reception, which can be determined by turning the equipment off and on, the user is encouraged to try to correct the interference by one or more of the following measures:

- Reorient or relocate the receiving antenna.
- Increase the separation between the equipment and receiver.
- Connect the equipment into an outlet on a circuit different from that to which the receiver is connected.
- Consult the dealer or an experienced radio/TV technician for help.

Application software installation

For Android Phones

- 1) Open [Google Play].
- 2) Search using the application name:
[Daikin One Home].
- 3) Follow the directions on the screen to install.

For iOS Phones

- 1) Open the [App Store].
- 2) Search using the application name:
[Daikin One Home].
- 3) Follow the directions on the screen to install.

Attention

- The actual application screen layout and content may differ from what is shown. The layout and content of the application screen is subject to change without notice.

Connect the air conditioner to your home network.

1. While operation is stopped, press  and hold the button for 5 seconds.

2. Press  or  and select menu number **3**.

- “SP” appears on the LCD.
- “3” blinks.

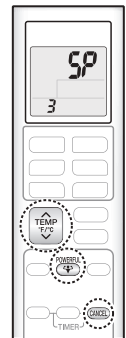

3. Press  to connect to the access point.

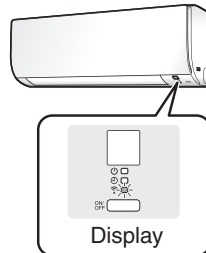



The wireless LAN connection adapter lamp blinks quickly.

4. Press  to return to the default screen.
No more settings need to be carried out from the remote controller.

5. Open Daikin One Home App and follow the instructions to set up the wireless LAN.

6. When the wireless LAN connection adapter lamp switches from blinking to lit, the connection is complete.

NOTE

- While “SP” is displayed, the options that can be selected using  and  are 1, 3, A, and OFF.
- Perform wireless LAN connection one indoor unit at a time.
- If you are unable to establish a network connection, refer the troubleshooting provided by the Daikin One Home App.
- When the lamp blinks slowly, the connection is not ready. Perform the connection procedure while it blinks quickly.

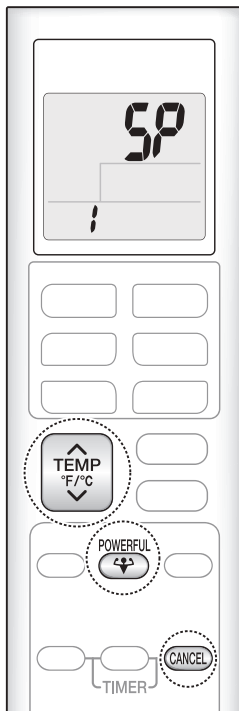

To confirm the wireless LAN connection adapter connection

■ To confirm

1. While operation is stopped, press and hold the button for 5 seconds.
2. Press to confirm the selected setting.

- “SP” appears on the LCD.
- “!” blinks.

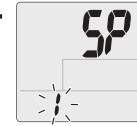

Check the indoor unit LED.

Wireless LAN connection adapter lamp	Status
Blinking for 1 second	Connection is not ready
Blinking for 3 seconds	Please initialize the wireless LAN connection adapter
Does not blink or light	Communication is abnormal There is a possibility of equipment failure Please request repair

To turn off the wireless connection

■ To use the remote controller

1. While operation is stopped, press and hold the button for 5 seconds.
2. Press or and select menu OFF.

- “SP” appears on the LCD.
- “OFF” blinks, and communication is OFF.

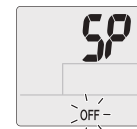

3. Press and hold the button for 2 seconds to confirm selected setting.
 - The wireless LAN connection adapter lamp turn off.
4. Press to return to the default screen.

To reset the connection setting to the factory default

- If you want to reset the connection settings, it is possible to initialize the wireless LAN connection adapter to its factory default state. If initialized, data including the network settings and power consumption history will be erased.
- When discarding or transferring to another user, initialize the connection adapter to erase the internal data.

■ To reset

1. While operation is stopped, press and hold the button for 5 seconds.
2. Press or and select menu R.

- “SP” appears on the LCD.
- “R” blinks.

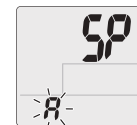

3. Press and hold the button for 2 seconds to confirm selected setting.
 - The wireless LAN connection adapter lamp blinks for 1 second.
4. Press to return to the default screen.

2.12 Other Functions

2.12.1 Hot-Start Function

In order to prevent the cold air blast that normally occurs when heating operation is started, the temperature of the indoor heat exchanger is detected, and the airflow is either stopped or significantly weakened resulting in comfortable heating.



Note(s)

The cold air blast is prevented using similar control when defrost control starts or when the thermostat is turned ON.

2.12.2 Signal Receiving Sign

When the indoor unit receives a signal from the remote controller, the unit emits a signal receiving sound and the operation lamp blinks.

2.12.3 Indoor Unit ON/OFF Switch

ON/OFF switch is provided on the display of the unit.

- Press **ON/OFF** switch once to start operation. Press once again to stop it.
- **ON/OFF** switch is useful when the remote controller is missing or the battery has run out.
- In the case of multi system operation, there are times when the unit does not activate with **ON/OFF** switch.

Operation mode	Temperature setting	Airflow rate
AUTO	25°C (77°F)	Automatic

07/09/12 class

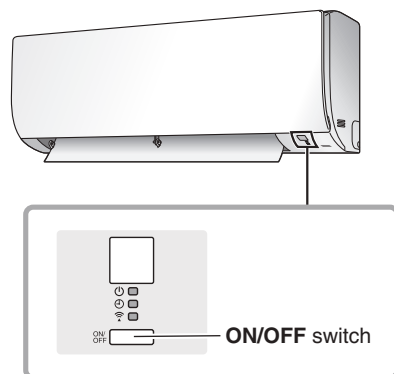

R4004127

15/18/24 class

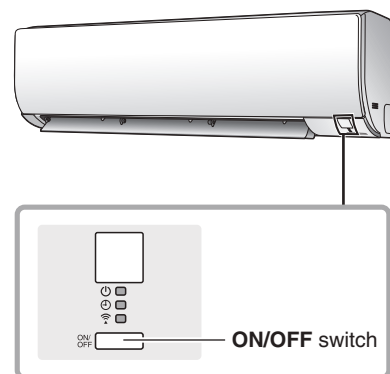

R4004128

2.12.4 Auto-restart Function

If a power failure (even a momentary one) occurs during the operation, the system restarts automatically in the same conditions as before when the power supply is restored to the conditions prior to the power failure.



Note

It takes 3 minutes to restart the operation because 3-minute standby function is activated.

3. Functions for Duct Concealed Type

3.1 Fan Speed Control for Indoor Unit

■ With Wired Remote Controller (BRC1NRV71)

To change the fan speed, press **Fan Speed** button and select the fan speed from Low/Medium/High/Auto.

- ♦ Auto cannot be selected if the indoor unit does not have Auto Fan speed function.
- ♦ The system may change the fan speed automatically for equipment protection purposes.
- ♦ The system may turn off the fan when the room temperature is satisfied.
- ♦ It is normal for delays to occur when changing the fan speed.
- ♦ If the Auto is selected for the fan speed, the fan speed varies automatically based on the difference between set temperature and room temperature.

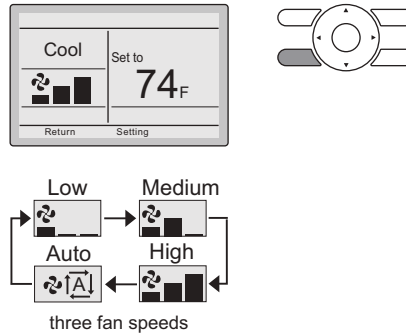

R4003380

3.2 Program Dry Operation

Outline

Program dry operation removes humidity while preventing the room temperature from lowering. Since the microcomputer controls both the temperature and airflow rate, the temperature adjustment and **FAN** setting buttons are inoperable.

Details

The microcomputer automatically sets the temperature and airflow rate. The difference between the room thermistor temperature at start-up and the target temperature is divided into two zones. Then, the unit operates in an appropriate capacity for each zone to maintain the temperature and humidity at a comfortable level.

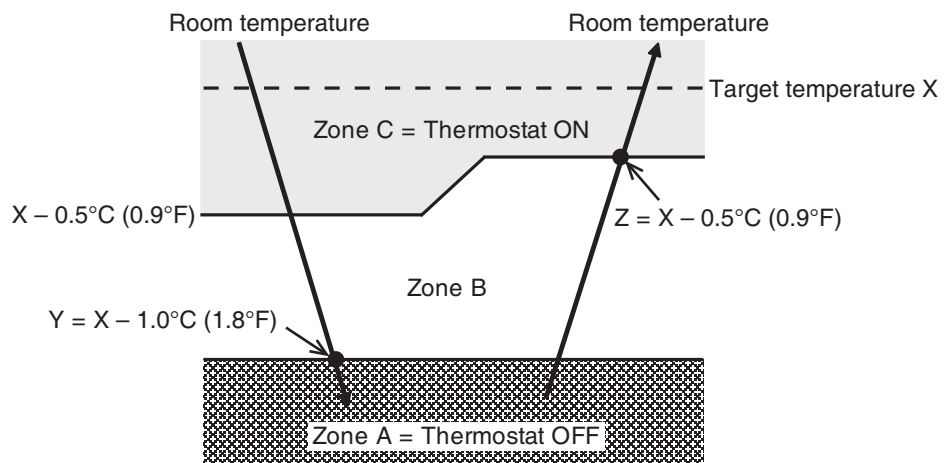

R4004276

Room thermistor temperature at start-up	Target temperature X	Thermostat OFF point Y	Thermostat ON point Z
16.5°C or more (61.7°F or more)	Room thermistor temperature at start-up	X - 1.0°C (X - 1.8°F)	X - 0.5°C (X - 0.9°F)
16°C or less (60.8°F or less)	16°C (60.8°F)	X - 2.0°C (X - 3.6°F)	X - 1.0°C = 15°C (X - 1.8°F = 59°F)

3.3 Automatic Cooling/Heating Change-over

Outline

When the automatic operation is selected with the remote controller, the microcomputer automatically determines the operation mode as cooling or heating according to the room temperature and the set temperature at start-up.
The unit automatically switches the operation mode to maintain the room temperature at the set temperature.

Details

Ts: set temperature (set by remote controller)
Tt: target temperature (determined by microcomputer)
Tr: room thermistor temperature (detected by room temperature thermistor)
C: correction value

1. The set temperature (Ts) determines the target temperature (Tt).
(Ts = 17 ~ 32°C (63 ~ 90°F))
2. The target temperature (Tt) is calculated as;
Tt = Ts + C
where C is the correction value.
C = 0°C (0°F)
3. Thermostat ON/OFF point and operation mode switching point are as follows.
 - (1) Heating → Cooling switching point:
Tr ≥ Tt + 2.5°C (+ 4.5°F)
 - (2) Cooling → Heating switching point:
Tr < Tt - 2.5°C (- 4.5°F)
 - (3) Thermostat ON/OFF point is the same as the ON/OFF point of cooling or heating operation.
4. During initial operation
Tr ≥ Ts : Cooling operation
Tr < Ts : Heating operation

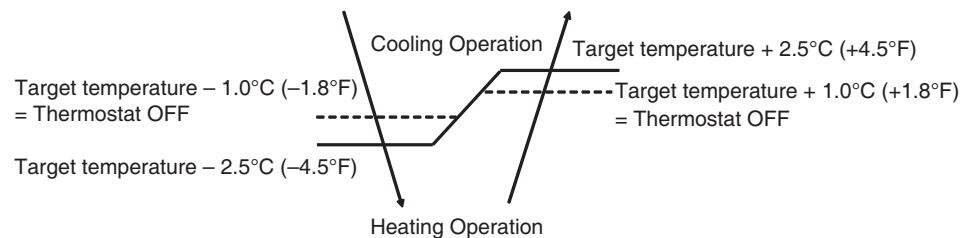

R4004277

Ex: When the target temperature is 25°C (77°F)
Cooling → 24°C (75.2°F): Thermostat OFF → 22.5°C (72.5°F): Switch to heating
Heating → 26°C (78.8°F): Thermostat OFF → 27.5°C (81.5°F): Switch to cooling

3.4 Clock and Calendar Setting (With BRC1NRV71)

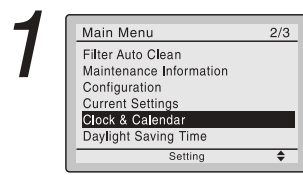

- Press **Menu/OK** button to display the main menu screen.
 - Press **▼▲** buttons to select **Clock & Calendar** on the main menu screen.
- Press **Menu/OK** button to display the clock & calendar screen.

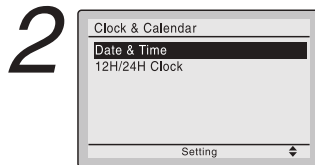
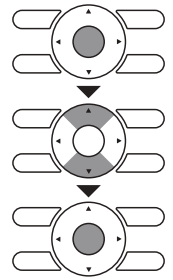

- Press **▼▲** buttons to select **Date & Time** on the clock & calendar screen.
- Press **Menu/OK** button to display the date & time screen.

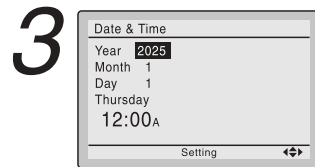
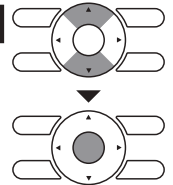

- Select **Year** with **◀▶** buttons.
- Change the year with **▼▲** buttons. Holding down the button causes the number to change continuously.

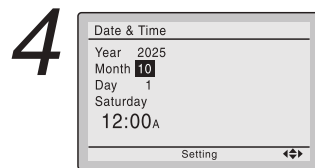
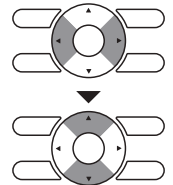

- Select **Month** with **◀▶** buttons.
- Change the month with **▼▲** buttons. Holding down the button causes the number to change continuously.

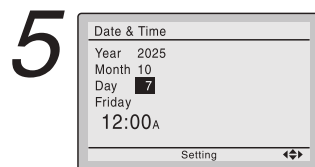
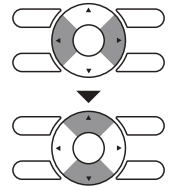

- Select **Day** with **◀▶** buttons.
- Change the day with **▼▲** buttons. Holding down the button causes the number to change continuously. Days of the week change automatically.

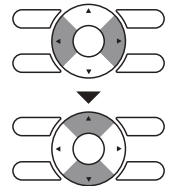

R4004248

6

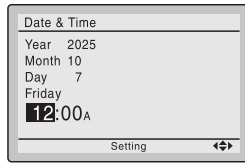

- Select **Hour** with ◀▶ buttons. Change the hour with ▼▲ buttons. Holding down the button causes the number to change continuously.

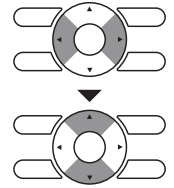

7

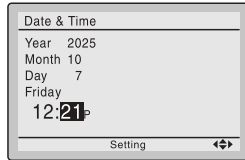

- Select **Minute** with ◀▶ buttons. Change the minute with ▼▲ buttons. Holding down the button causes the number to change continuously.
- Press **Menu/OK** button. The confirmation screen will appear.

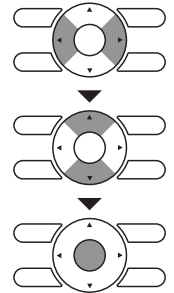

Note:

The date can be set between January 1, 2020 and December 31, 2099.

8

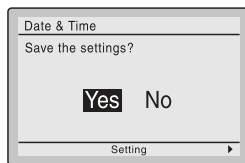

- Press ◀▶ button to select **Yes** on the confirmation screen. Press **Menu/OK** button to confirm the clock and return to the basic screen.

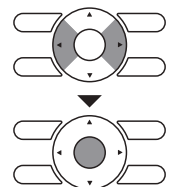

* When setting the schedule, the display returns to the settings screen.

R4004249

3.5 Schedule Timer Operation (With BRC1NRV71)

Outline

Day settings are selected from 4 patterns:

- 7 Days
- Weekday/Sat/Sun
- Weekday/Weekend
- Everyday

Up to 5 actions can be set for each day.

Details

Set the startup time and operation stop time.

ON: Startup time, cooling and heating temperature setpoints can be configured.

OFF: Operation stop time, cooling and heating setback temperature setpoints can be configured.

(--: Indicates that the setback function is disabled for this time period.)

_: Indicates that the temperature setpoint and setback temperature setpoint for this time period is not specified. The last active setpoint will be utilized.

■ **Setting the schedule**

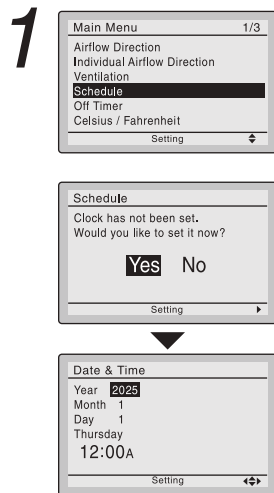

- Press **Menu/OK** button to display the main menu screen.
- Press **▼▲** buttons to select **Schedule**. Press **Menu/OK** button to display the schedule screen.
- Before setting the schedule, the clock must be set.
- If the clock has not been set, a screen like the one on the left will appear. Press **◀▶** buttons to select **Yes** and press **Menu/OK** button.
- The date & time screen will appear.
- Set the current year, month, day, and time.

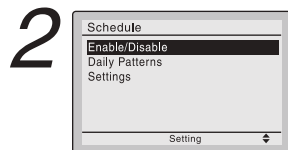
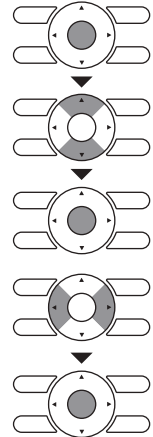

- Press **▼▲** buttons to select the desired function on the schedule screen and press **Menu/OK** button.

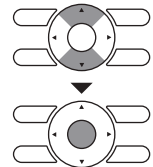

R4004250

■ Daily Patterns

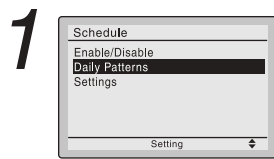

- The schedule screen will appear.
- Press ▼▲ buttons to select **Daily Patterns** on the schedule screen. The daily patterns screen will appear when **Menu/OK** button is pressed.

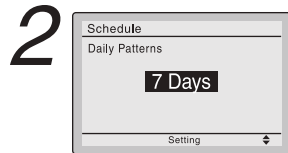
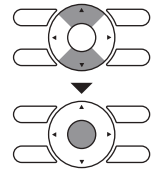

- Press ▼▲ buttons to select **7 Days**, **Weekday/Sat/Sun**, **Weekday/Weekend** or **Everyday** on the daily patterns screen. The confirmation screen will appear when **Menu/OK** button is pressed.

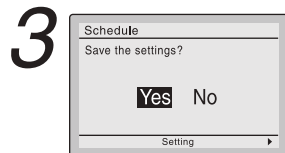
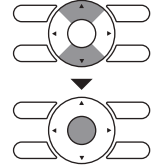

- Press ◀▶ buttons to select **Yes** on the confirmation screen. Pressing **Menu/OK** button enters the daily patterns in the schedule and takes you back to the main menu screen.

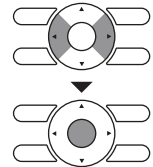

(R24074)

■ Settings

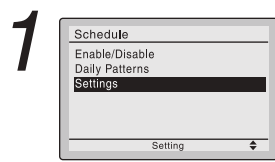

- The schedule screen will appear.
- Press ▼▲ buttons to select **Settings** on the schedule screen. The settings screen will appear when **Menu/OK** button is pressed.

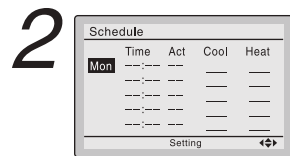
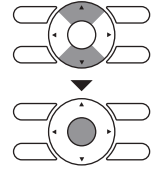

- Press ▼▲ buttons to select the day to be set.
- * It cannot be selected in the case of **EVDY**.

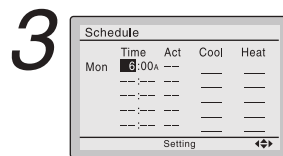
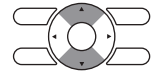

- Input the time for the selected day.
- Press ◀▶ buttons to move the highlighted item and press ▼▲ buttons to input the desired operation start time. Each press of ▼▲ buttons moves the numbers by 1 hour or 1 minute.

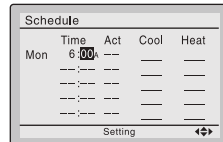
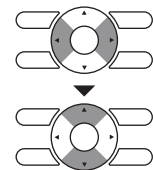

R4003456

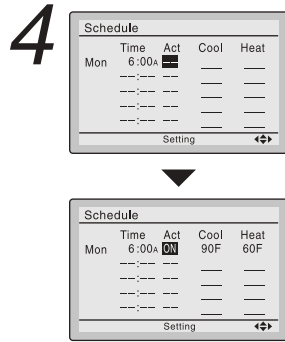

- Press ◀▶ buttons to move the highlighted item and press ▼▲ buttons to configure ON/OFF/-- settings. --, ON, or OFF changes in sequence when ▼▲ buttons are pressed.

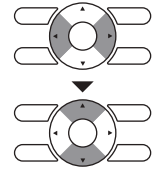

- ON: The temperature setpoints can be configured.
- OFF: The setback temperature setpoints can be configured.
- : The temperature setpoints and setback temperature setpoints become disabled.

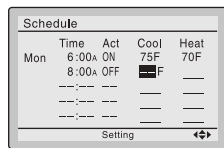

- The cooling and heating temperature setpoints for both ON and OFF (Setback) are configured.

- : Indicates that the temperature setpoint and setback temperature setpoint for this time period is not specified. The last active setpoint will be utilized.
- : Indicates that the setback function is disabled for this time period.

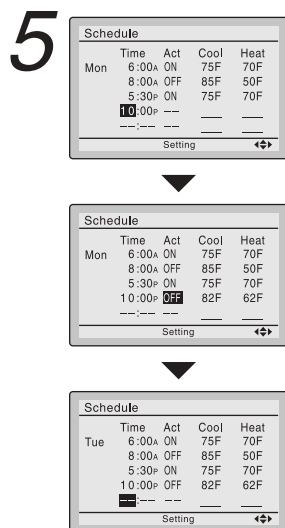

A maximum of five actions per day can be set.

- Press **Menu/OK** button when settings for each day are completed. The confirmation screen will appear.

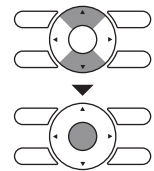

To copy the settings for the previous day, press **Mode** button so that the existing settings will be copied.

Example: The contents for Monday are copied by pressing **Mode** button after selecting Tuesday.

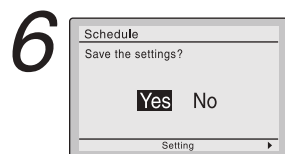

- Press ◀▶ buttons to select **Yes** on the confirmation screen. Pressing **Menu/OK** button confirms the settings for each day and takes you back to the basic screen.

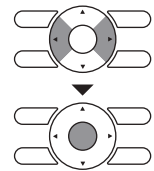

(R24075)

■ Enabling or disabling the schedule

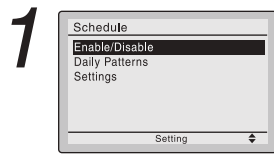

- Display the schedule screen.
- Press ▼▲ buttons to select **Enable / Disable** on the schedule screen. Press **Menu/OK** button to display the enable/disable screen.

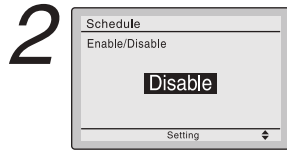
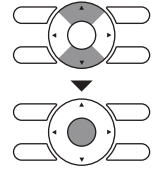

- Press ▼▲ buttons to select **Enable** or **Disable** on the enable/disable screen. Press **Menu/OK** button after selecting the item. The confirmation screen is displayed.

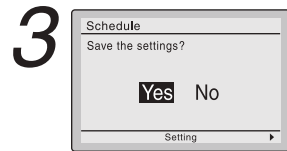
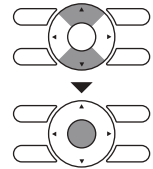

- Press ◀▶ buttons to select **Yes** on the confirmation screen. Pressing **Menu/OK** button confirms the enable/disable setting for the schedule and takes you back to the basic screen.

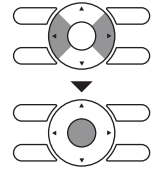

R4003458

3.6 Drain Pump Control

Normal Operation

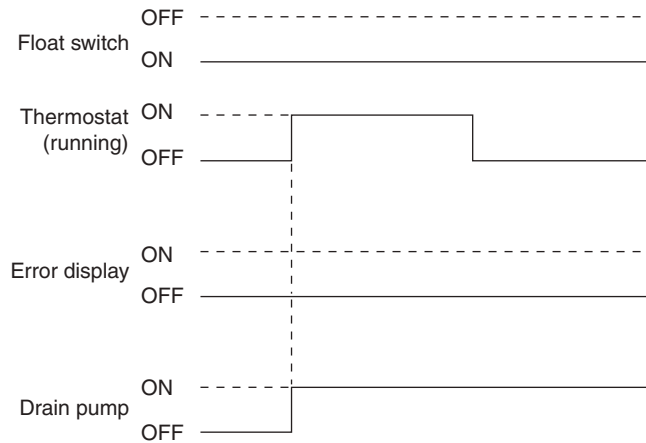

(R24037)

- The float switch is ON in normal operation.
- When cooling operation starts (thermostat ON), the drain pump turns ON simultaneously.
- After the thermostat turns OFF, the drain pump continues to operate.

If Float Switch is OFF with Thermostat ON in Cooling Operation

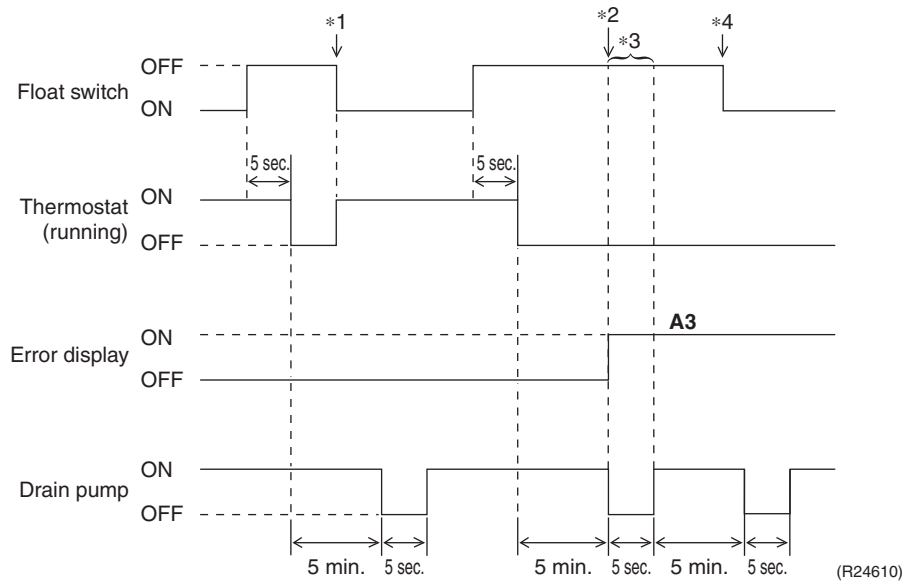

- When the float switch stays OFF for 5 sec., the thermostat turns OFF.
- After the thermostat turns OFF, the drain pump continues to operate for another 5 minutes.
- *1. If the float switch turns ON again during the residual operation of the drain pump, cooling operation also turns on again (thermostat ON).
- *2. If the float switch remains OFF even after the residual operation of the drain pump has ended, the error code **A3** is determined.
- *3. The drain pump turns OFF once residual operation has ended, then turns ON again after 5 seconds.
- *4. After **A3** is determined and the unit comes to an abnormal stop, the thermostat will remain OFF even if the float switch turns ON again.

If Float Switch is OFF with Thermostat OFF in Cooling Operation

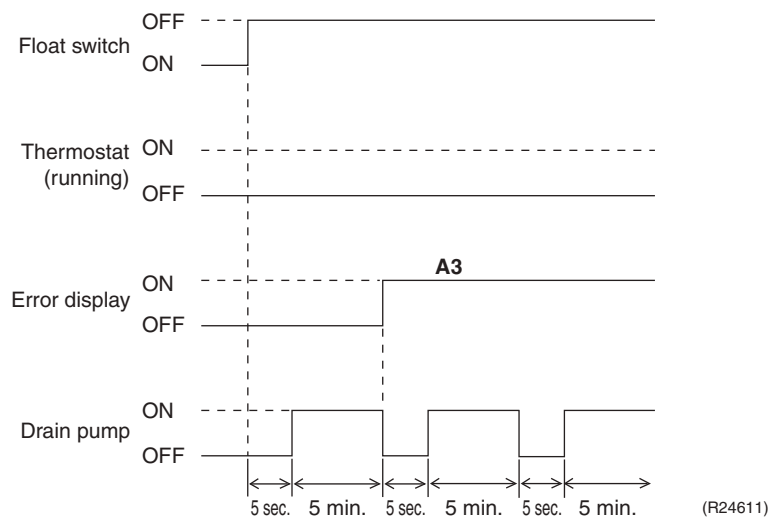

- When the float switch stays OFF for 5 sec., the drain pump turns ON.
- If the float switch remains OFF even after the residual operation of the drain pump has ended, the error code **A3** is determined.
- The drain pump turns OFF once residual operation has ended, then turns ON again after 5 seconds.

If Float Switch Turns ON and OFF Continuously, or Float Switch Turns OFF While AF Displayed

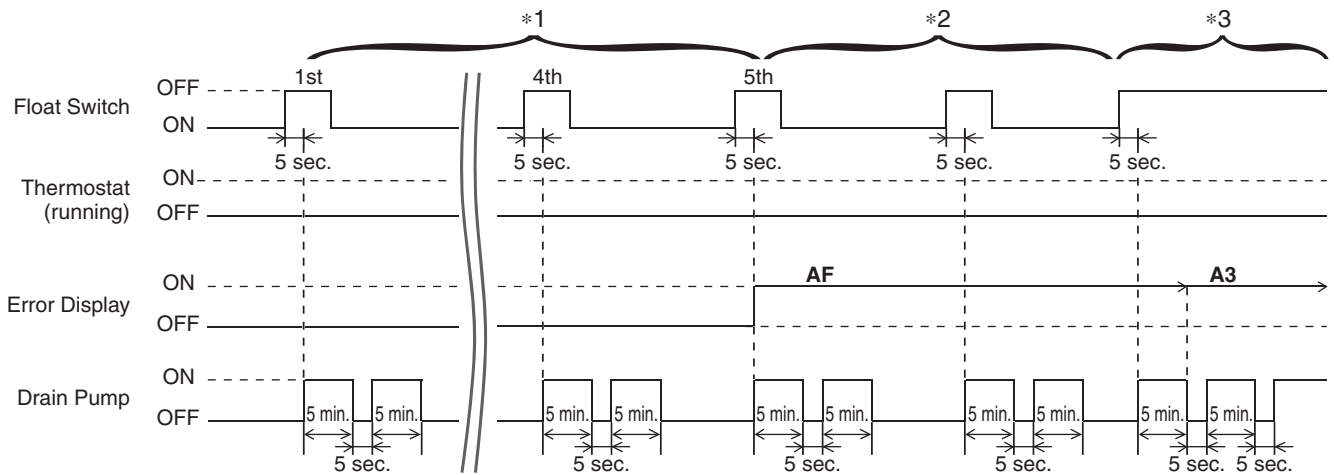

(R24370)

- When the float switch stays OFF for 5 sec., the drain pump turns ON.
 - *1. If the float switch continues to turn OFF and ON 5 times consecutively, it is judged as a drain system error and the error code **AF** is determined.
 - *2. The drain pump continues to turn ON/OFF in accordance with the float switch ON/OFF even after **AF** is determined.
 - *3. While the error code **AF** is displayed, if the float switch remains OFF even after the residual operation of the drain pump has ended, the error code **A3** will be determined.

3.7 Hot Start Control (In Heating Operation Only)

Outline

At startup with thermostat ON or after the completion of defrosting in heating operation, the indoor unit fan is controlled to prevent cold air from blasting out and ensure startup capacity.

Details

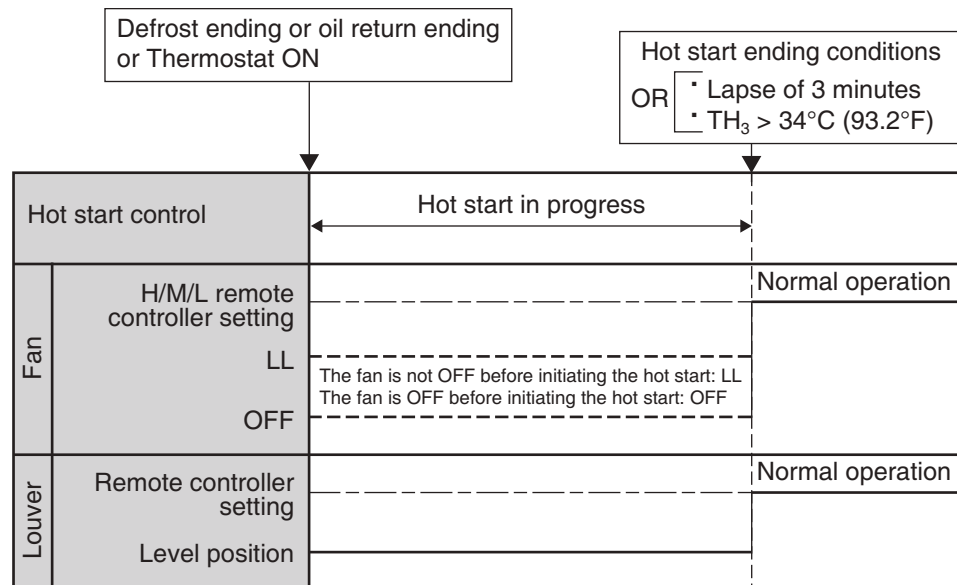

R4004278

TH₃: Temperature detected by the indoor heat exchanger thermistor (R3T)

3.8 Other Functions

3.8.1 Refrigerant Detection System (RDS) Function

Refrigerant Detection System (RDS) is installed in this equipment to detect any refrigerant leakage in the coil and leak detection sensor failure and conduct safety actions in the following table to mitigate any risk of ignition/fire.

In case that a leak is detected, the safety actions start when a leak is detected by leak detection sensor and continue until 5 minutes elapsed after a leak stops being detected.

In case of leak detection sensor failure, the same safety actions are performed.

Item (function)	Leak actions
Remote controller	Display of error code A0-17 , A0-19 or CH-11 , CH-14
Fan motor	Run at LL or greater tap
Compressor	OFF

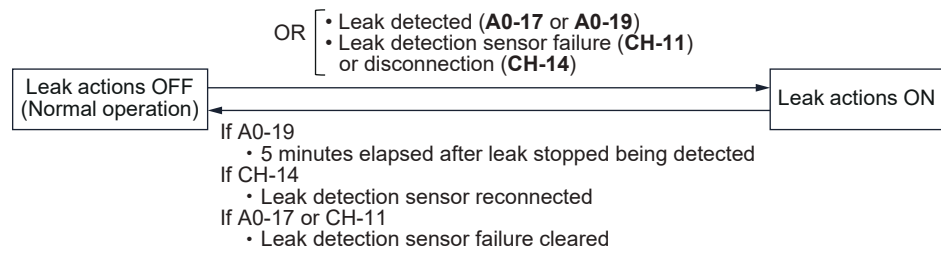

3.8.2 Auto-restart Function

If a power failure (even a momentary one) occurs during the operation, the system restarts automatically in the same conditions as before when the power supply is restored to the conditions prior to the power failure.



Note

It takes 3 minutes to restart the operation because 3-minute standby function is activated.

4. Functions for Floor Standing Type

4.1 Airflow Direction Control

Air Outlet Selection Setting

Set so that the unit determines automatically which air outlet to use or select the upper air outlet only.

1. Press **Menu** button for at least 2 seconds.
2. The led appears and **1** (menu number) blinks.
3. Press **Select ▲** or **Select ▼** button to change the menu to **2** (indoor unit position setting). The icon appears and **2** (menu number) blinks.

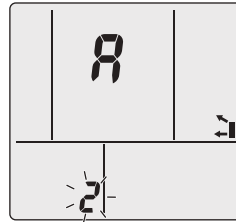

4. Press **Menu** button to confirm the setting value.
5. Press **Select ▲** or **Select ▼** button to change the setting as follows.

R4004058

Setting	Selection	LCD	Air outlet selection
Automatic air outlet selection (factory default setting)		Blinks 	 Upper and lower air outlet : The unit decides automatically the best air outlet depending on the operation mode or room conditions.
Upper air outlet only		Blinks 	 Upper air outlet : The airflow is set to top air outlet, regardless of the operation mode or room conditions.
Setting	Operation	Situation	Air outlet selection
	DRY	Any situation	
	COOL	Upper air outlet : When the room temperature reaches the set point or the total operation time at high humidity reaches 60 minutes. Upper and lower air outlet : When the set point temperature is not reached yet, or the total operation time at high humidity is less than 60 minutes.	
	HEAT/FAN	Any situation	
	DRY/COOL/HEAT/FAN	Any situation	

- During drying operation the airflow comes from the top air outlet only.
Refer to “**Operation mode**” and “**To change the temperature**” for setting.
- During FLOOR WARMING operation, the airflow comes from the bottom air outlet only.

R4004059



6. Press **Menu** button once again to confirm the setting value.
7. Press **Cancel** button to return to the default screen.

Note(s)

- The display automatically returns to the default screen after 60 seconds. To return to the initial screen immediately, press **Cancel** button twice.
- If you change the setting from automatic air outlet selection to upper air outlet only during HEAT operation, heating is temporarily stopped to protect the unit.
- When the setting is changed to “Upper air outlet only”, cooling/heating capacity will be reduced, and operating sounds will increase. Additionally, hot or cold spots may form more easily. Use when you do not want air to flow from the lower air outlet (e.g., during sleep hours).
- During COOL operation, there are cases where air flows from the upper outlet only when set to Automatic air outlet selection. In such cases, if operating sound becomes an issue, lowering the airflow rate or setting it to AUTO may provide improvement.
- During FLOOR WARMING operation, air is emitted only from the lower air outlet.
- When airflow direction changes, sounds may be heard from inside the lower air outlet as it opens/closes.



Wide-Angle Louvers

The louvers, made of elastic synthetic resin, provide a wide range of airflow that guarantees comfortable air distribution.

	Right and Left (manual)
Upper air outlet	 R4004060
Lower air outlet	 R4004061

Auto-Swing

The following tables explain the auto-swing process for cooling, dry, heating and fan:

Flap (up and down)	
Cooling/Dry	Heating/Fan
 R4004063	 R4004064

4.2 FLOOR WARMING Operation

Outline

FLOOR WARMING operation can effectively warm large floor areas by closing the top air outlet and increasing the air velocity to reach distant floor surfaces.

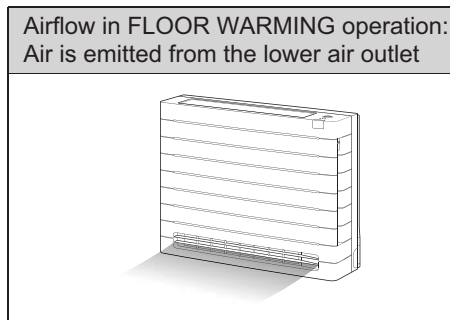

HEAT operation

R4004288

Operation



To start the operation:

- Press **Floor Warming** button.
The icon appears on the display.

To stop the operation:

- Press **Floor Warming** button again.
The icon disappears from the display.



Note(s)

- FLOOR WARMING operation is not available in AUTO / DRY / COOL / FAN mode.
- Although the flap will be closed, air will still be emitted from around the flap.
- Operating sounds will be louder than when air is emitted from both the upper and lower air outlets.
- Only the automatic air outlet selection setting can be used during FLOOR WARMING operation. Air is emitted from the lower air outlet only.
- FLOOR WARMING operation can only be used in HEAT operation mode and with the automatic air outlet selection setting.
- If the room temperature is low, the room may not get warm enough.

4.3 Fan Speed Control for Indoor Unit

Outline

Phase control and fan speed control contains 9 steps: LLL, LL, SL, L, ML, M, MH, H, and HH. The airflow rate can be automatically controlled depending on the difference between the room thermistor temperature and the target temperature. This is done through phase control and Hall IC control.



Reference

For more information about Hall IC, refer to the troubleshooting for fan motor on page 211.

Automatic Fan Speed Control

In automatic fan speed operation, the step SL is not available.

Step	Cooling	Heating
LLL		
LL	↕	↕
L		
ML		
M		
MH		
H		
HH (POWERFUL)		

↕ = The airflow rate is automatically controlled within this range when **Fan** button is set to automatic.

R4004353

Cooling

The following drawing explains the principle of fan speed control for cooling.

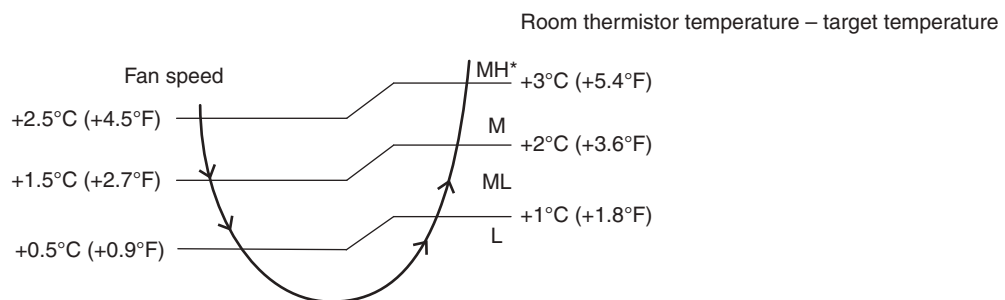

(R21654)

* During operation at L tap, operation at LL tap may be performed to control humidity.

Heating

In heating operation, the fan speed is regulated according to the indoor heat exchanger temperature and the difference between the room thermistor temperature and the target temperature.



Note

The fan stops during defrost operation.

4.4 Program Dry Operation

Outline

Program dry operation removes humidity while preventing the room temperature from lowering. Since the microcomputer controls both the temperature and airflow rate, the temperature adjustment and **Fan** setting buttons are inoperable.

Details

The microcomputer automatically sets the temperature and airflow rate. The difference between the room thermistor temperature at start-up and the target temperature is divided into two zones. Then, the unit operates in an appropriate capacity for each zone to maintain the temperature and humidity at a comfortable level.

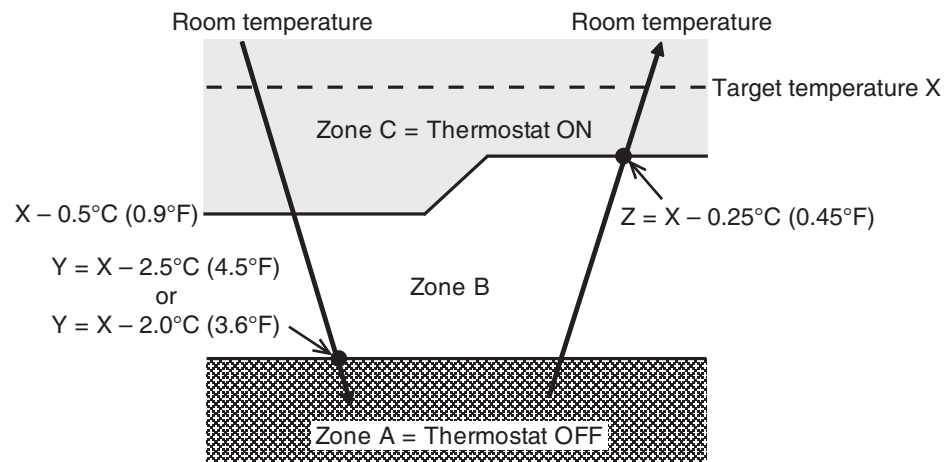

R4004354

Room thermistor temperature at start-up	Target temperature X	Thermostat OFF point Y	Thermostat ON point Z ★
24°C or more (75.2°F or more)	Room thermistor temperature at start-up	X - 1.25°C (X - 2.25°F)	X - 0.25°C (X - 0.45°F)
18 ~ 23.5°C (64.4 ~ 74.3°F)		X - 1.0°C (X - 1.8°F)	X - 0.25°C (X - 0.45°F)
17.5°C or less (63.5°F or less)	18°C (64.4°F)	X - 1.0°C (X - 1.8°F)	X - 0.25°C (X - 0.45°F)

★ Thermostat turns on also when the room temperature is in the zone B for 450 seconds.

4.5 Automatic Cooling/Heating Change-over

Outline

When the automatic operation is selected with the remote controller, the microcomputer automatically determines the operation mode as cooling or heating according to the room temperature and the set temperature at start-up.
The unit automatically switches the operation mode to maintain the room temperature at the set temperature.

Details

Ts: set temperature (set by remote controller)
Tt: target temperature (determined by microcomputer)
Tr: room thermistor temperature (detected by room temperature thermistor)
C: correction value

1. The set temperature (Ts) determines the target temperature (Tt).
(Ts = 18 ~ 30°C (64.4 ~ 86°F))
2. The target temperature (Tt) is calculated as;
Tt = Ts + C
where C is the correction value.
C = 0°C (0°F)
3. Thermostat ON/OFF point and operation mode switching point are as follows.
 - (1) Heating → Cooling switching point:
Tr ≥ Tt + 3.0°C (+ 5.4°F)
 - (2) Cooling → Heating switching point:
Tr < Tt - 2.5°C (- 4.5°F)
 - (3) Thermostat ON/OFF point is the same as the ON/OFF point of cooling or heating operation.
4. During initial operation
Tr ≥ Ts : Cooling operation
Tr < Ts : Heating operation

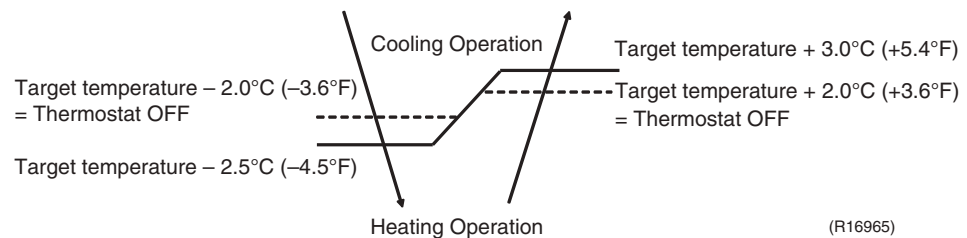

Ex: When the target temperature is 25°C (77°F)
Cooling → 23°C (73.4°F): Thermostat OFF → 22.5°C (72.5°F): Switch to heating
Heating → 27°C (80.6°F): Thermostat OFF → 28°C (82.4°F): Switch to cooling

4.6 Thermostat Control

Outline Thermostat control is based on the difference between the room thermistor temperature and the target temperature.

Details

Thermostat OFF Conditions

- The temperature difference is in the zone A.

Thermostat ON Conditions

- The temperature difference returns to the zone C after being in the zone A.
- The system resumes from defrost control in any zones except A.
- The operation turns on in any zones except A.
- The monitoring time has passed while the temperature difference is in the zone B.
(Cooling : 10 minutes, Heating : 1 minute)

Cooling

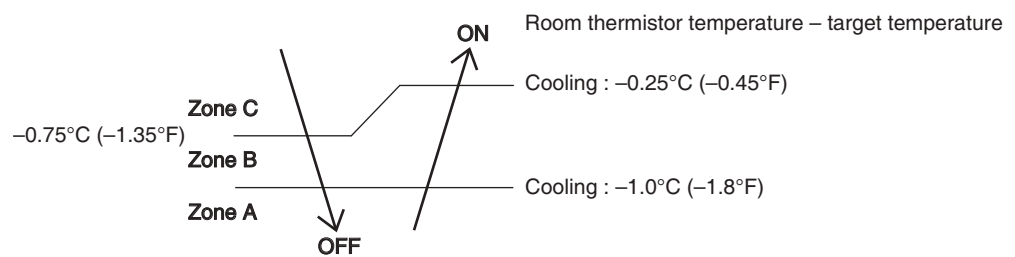

R4004355

Heating

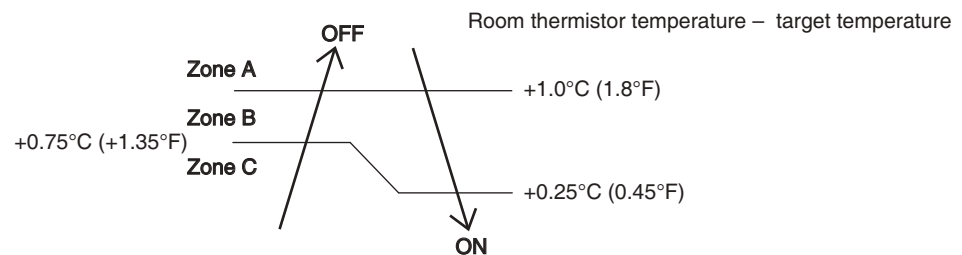

R4004356



Reference

Refer to Temperature Control on page 48 for details.

4.7 NIGHT SET Mode

Outline When the OFF TIMER is set, NIGHT SET mode is automatically activated. NIGHT SET mode keeps the airflow rate setting.

Details NIGHT SET mode continues operation at the target temperature for the first one hour, then automatically raises the target temperature slightly in the case of cooling, or lowers the target temperature slightly in the case of heating. This prevents excessive cooling in summer and excessive heating in winter to ensure comfortable sleeping conditions, and also conserves electricity.

Cooling

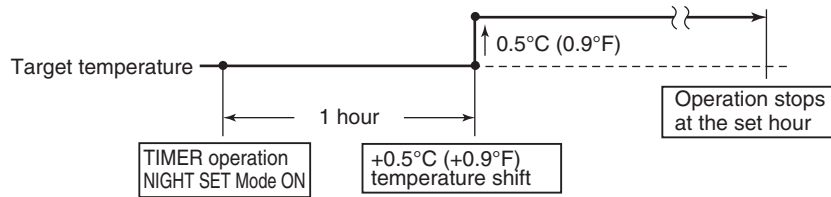

(R23917)

Heating

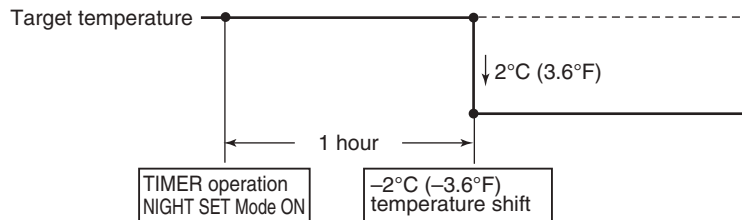

(R23918)

4.8 ECONO Operation

Outline ECONO operation reduces the maximum operating current and the power consumption. This operation is particularly convenient for energy-saving. It is also a major bonus when breaker capacity does not allow the use of multiple electrical devices and air conditioners. It can be easily activated by pressing **Econo/Quiet** button on the wireless remote controller.

- Details**
- When this function is activated, the maximum capacity also decreases.
 - The remote controller can send the ECONO command when the unit is in cooling, heating, dry, or automatic operation. This function can only be set when the unit is running. To cancel the ECONO operation, press **Econo/Quiet** button several times until the ECONO symbol disappears.
 - This function and POWERFUL, FLOOR WARMING or HEATPLUS operation cannot be used at the same time. The latest command has priority.

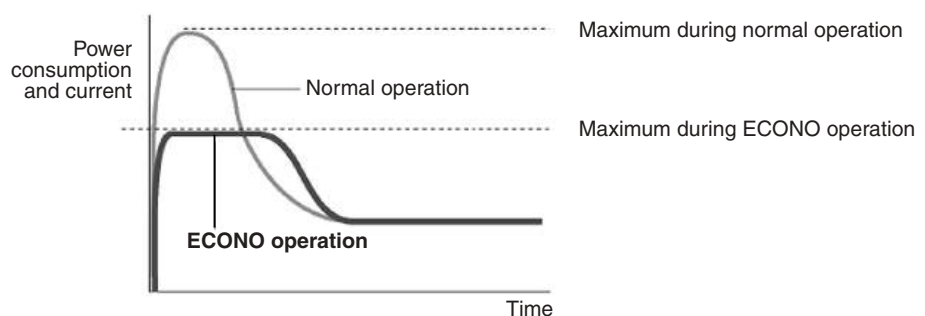

(R22012)

4.9 HOME LEAVE Operation

Outline

HOME LEAVE operation is a function that allows you to record your preferred set temperature and airflow rate. You can start your preferred operation mode simply by pressing the **Home Leave** button on the remote controller.

Details

1. Start of Function

The function starts when **Home Leave** button is pressed in cooling operation, heating operation (including POWERFUL operation), or while the operation is stopped. If **Home Leave** button is pressed in POWERFUL, FLOOR WARMING or HEATPLUS operation, each operation is canceled and the HOME LEAVE function becomes effective.

- **Home Leave** button is ineffective in dry operation and fan operation.

2. Details of Function

A mark representing HOME LEAVE is indicated on the display of the remote controller. The indoor unit is operated according to the set temperature and airflow rate for HOME LEAVE which were recorded in the memory of the remote controller.

The LED (green) of indoor unit representing HOME LEAVE lights up. (It goes out when the operation is stopped.)

3. End of Function

The function ends when **Home Leave** button is pressed again during HOME LEAVE operation or when **POWERFUL** or **FLOOR WARMING** button is pressed.

- **Every day before you leave the house...**

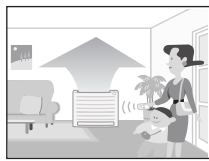

When you go out, push the "HOME LEAVE Operation" button, and the air conditioner will adjust capacity to reach the preset temperature for HOME LEAVE Operation.



When you return, you will be welcomed by a comfortably air conditioned room.

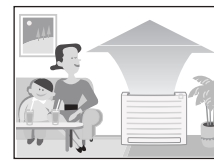

Push the "HOME LEAVE Operation" button again, and the air conditioner will adjust capacity to the set temperature for normal operation.

- **Before bed...**

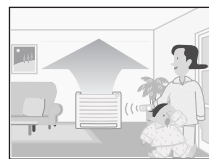

Set the unit to HOME LEAVE Operation before leaving the living room when going to bed.



The unit will maintain the temperature in the room at a comfortable level while you sleep.

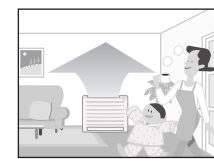

When you enter the living room in the morning, the temperature will be just right. Disengaging HOME LEAVE Operation will return the temperature to that set for normal operation. Even the coldest winters will pose no problem!

How to Set the Temperature and Airflow Rate

When using HOME LEAVE operation for the first time, set the temperature and airflow rate for HOME LEAVE operation. Record your preferred temperature and airflow rate.

	Initial setting		Selectable range	
	Temperature	Airflow rate	Temperature	Airflow rate
Cooling	90 °F (32.0 °C)	(A)	64 ~ 90 °F (18.0 ~ 32.0 °C)	5 steps, (A), (B)
Heating	50 °F (10.0 °C)	(A)	50 ~ 86 °F (10.0 ~ 30.0 °C)	5 steps, (A), (B)

1. Press the **Home Leave** button.

Make sure  is displayed on the remote controller display.

2. Adjust the temperature with ▲ or ▼ as you like.

3. Adjust the airflow rate with the **Fan** button as you like.
HOME LEAVE operation will run with these settings the next time you start HOME LEAVE operation. To change the recorded information, repeat steps 1 - 3.

Others

- The set temperature and airflow rate are memorized in the remote controller. When the remote controller is reset due to replacement of battery, it is necessary to set the temperature and airflow rate again for HOME LEAVE operation.
- The operation mode cannot be changed while HOME LEAVE operation is being used.

4.10 POWERFUL Operation

Outline

In order to exploit the cooling and heating capacity to full extent, the air conditioner can be operated by increasing the indoor fan rotating speed and the compressor frequency.

Details

When **POWERFUL/HEAT PLUS** button is pressed, the fan speed and target temperature are converted to the following states for 20 minutes.

Operation mode	Fan speed	Target temperature
COOL	H tap + A rpm	18°C (64.4°F)
DRY	Dry rotating speed + A rpm	Lowered by 2.5°C (4.5°F)
HEAT	H tap + A rpm	32°C (89.6°F)
FAN	H tap + A rpm	—
AUTO	Same as cooling/heating in POWERFUL operation	The target temperature is kept unchanged.

A = 20 ~ 40 rpm (depending on the model)

Ex: POWERFUL operation in cooling

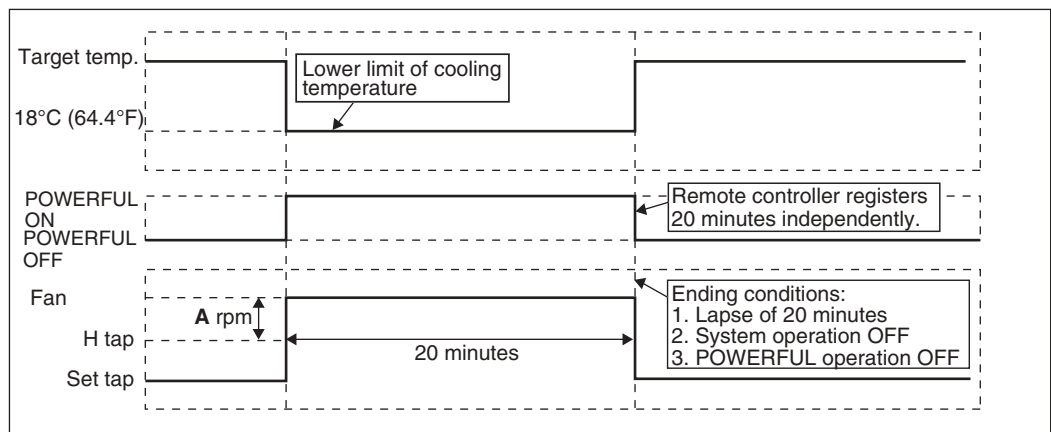

(R24589)



Note

POWERFUL operation cannot be used together with HEAT PLUS, FLOOR WARMING, ECONO, Home Leave or QUIET OUTDOOR UNIT operation.

4.11 HEAT PLUS Operation

Outline

When **POWERFUL/HEAT PLUS** button is pressed, temperature of the air blowing out from the air conditioner operating in the room will increase and high discharge temperature will be kept. HEAT PLUS operation will stop when a predetermined time has elapsed or upon request from the remote controller to change operation mode.

Operation mode will return to heating after HEAT PLUS operation.

Temperature and airflow rate will return to the status previous to the HEAT PLUS operation.

Details

The temperature has been realized by controlling the outdoor unit according to the methods shown below and suppressing the airflow of the indoor unit.

- Increase the maximum allowable temperature of the condenser (saturated temperature under the current pressure).
- Increase the compressor frequency at the maximum level based on the number of rooms.
- Control the openings of the pressure reducing valves for individual rooms to provide more refrigerant to the room where HEAT PLUS operation has been activated.
- To gather heating capacity to the room where HEAT PLUS operation is activated, stop allocating the capacity to the rooms where room temperature has already reached to the target temperature.

Operation mode will return to the normal heating operation 30 minutes after HEAT PLUS operation is started.



Notes

- If room temperature is low, the entire room may not become warm enough.
- After 30 minutes of HEAT PLUS operation, the air conditioner may operate with reduced capacity depending on the target temperature because the room temperature is sufficiently high.
- Human body should not be exposed to the hot blowing air of HEAT PLUS near the air outlet for a long period of time.
- Temperature around indoor units in other rooms may increase.



Notes

HEAT PLUS operation cannot be used together with POWERFUL, FLOOR WARMING, ECONO, Home Leave or QUIET OUTDOOR UNIT operation.

4.12 Operation lamp (Multi-color)

Features

Current operation mode is displayed in color of the lamp of the indoor unit. Operating status can be monitored even in automatic operation in accordance with the actual operation mode.

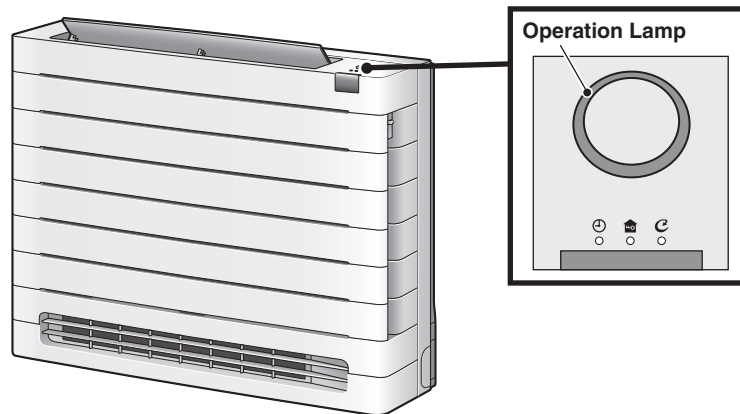

R4004357

Color	State	Description
Red/Blue	Lights up	AUTO operation.
Green	Lights up	DRY operation.
Blue	Lights up	COOL operation.
Red	Lights up	HEAT operation.
White	Lights up	FAN operation.
Depends on operation mode	Blinks	Check the error code.
Red	Blinks	Operation is stopped but the wireless LAN connecting adapter is enabled.
Blue	Blinks	Operation is stopped but the wireless LAN connecting adapter is connected.





Reference

Refer to page 95 for brightness setting of indoor unit display.

4.13 Clock Setting

ARC466 Series

The clock can be set by taking the following steps:

1. Press **Clock** button.
→ **0:00** is displayed, then **MON** and  blink.
2. Press **Select ▲** or **Select ▼** button to set the clock to the current day of the week.
3. Press **Clock** button.
→  blinks.
4. Press **Select ▲** or **Select ▼** button to set the clock to the present time.
Holding down **Select ▲** or **Select ▼** button rapidly increases or decreases the time display.
5. Press **Clock** button to set the clock. Point the remote controller at the indoor unit when pressing the button.
→  : blinks and clock setting is completed.

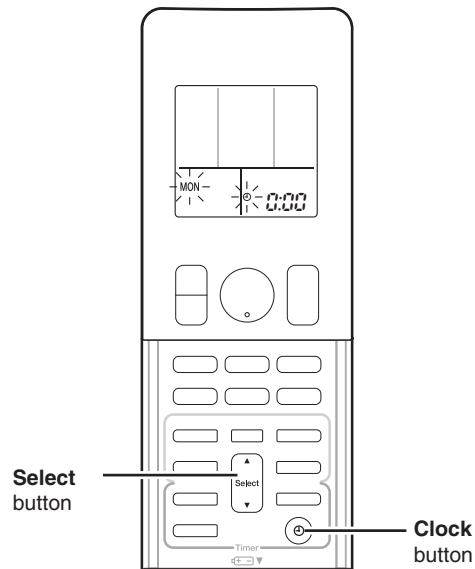

(R19926)

4.14 WEEKLY TIMER Operation

Outline Up to 4 timer settings can be saved for each day of the week (up to 28 settings in total). The 3 items: ON/OFF, temperature, and time can be set.

Details

Setting example of the WEEKLY TIMER

The same timer settings are used from Monday through Friday, while different timer settings are used for the weekend.

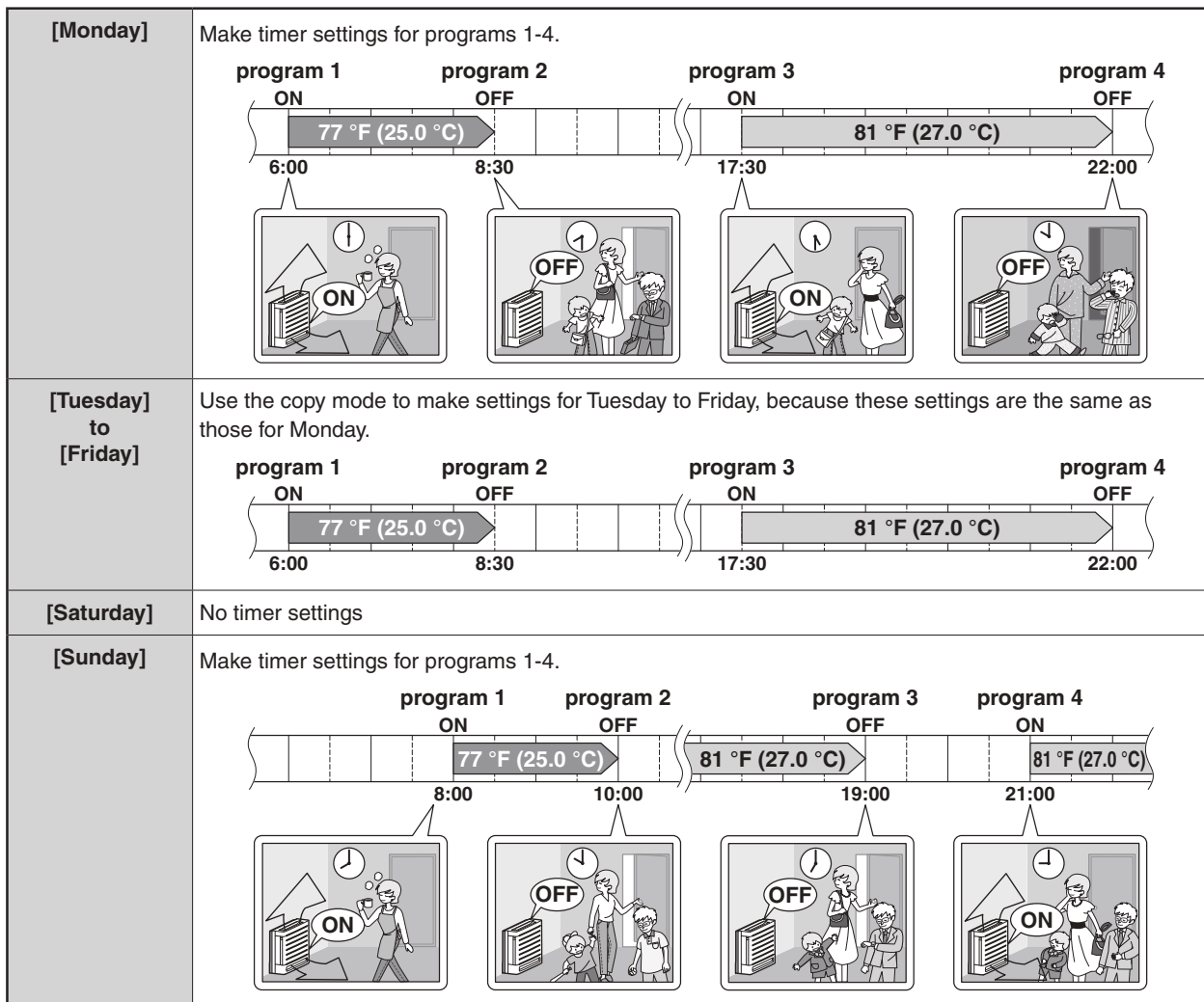

- Up to 4 reservations per day and 28 reservations per week can be set using the WEEKLY TIMER. The effective use of the copy mode simplifies timer programming.
- The use of ON-ON-ON-ON settings, for example, makes it possible to schedule operating mode and set temperature changes. Furthermore, by using OFF-OFF-OFF-OFF settings, only the turn off time of each day can be set. This will turn off the air conditioner automatically if you forget to turn it off.

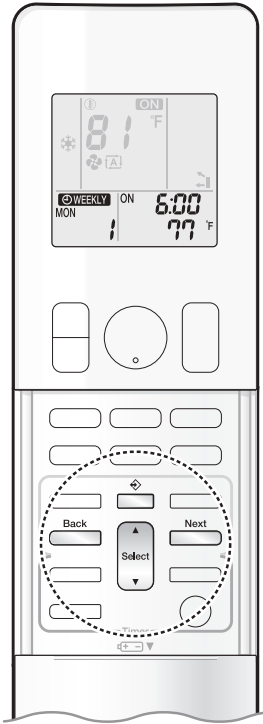

To use WEEKLY TIMER operation

Setting mode

- Make sure the day of the week and time are set. If not, set the day of the week and time.

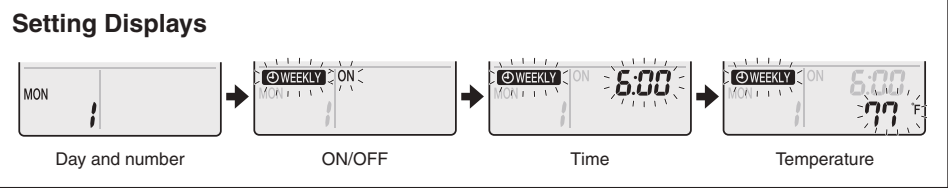
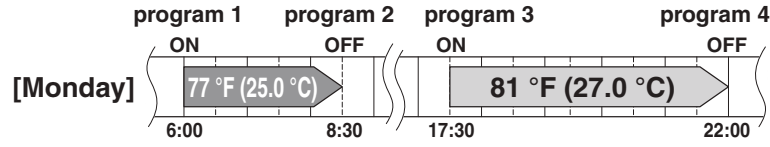

1. Press [Up Arrow].

- The day of the week and the reservation number of the current day will be displayed.
- 1 to 4 settings can be made per day.

2. Press [Select] to select the desired day of the week and reservation number.

- Pressing [Select] changes the reservation number and the day of the week.

3. Press [Next].

- The day of the week and reservation number will be set.
- "WEEKLY" and "ON" blink.

4. Press [Select] to select the desired mode.

- Pressing [Select] changes the "ON" or "OFF" setting in sequence.



- In case the reservation has already been set, selecting "blank" deletes the reservation.
- Proceed to **STEP 9** if "blank" is selected.
- To return to the day of the week and reservation number setting, press [Back].

5. Press [Next].

- The ON/OFF TIMER mode will be set.
- "WEEKLY" and the time blink.

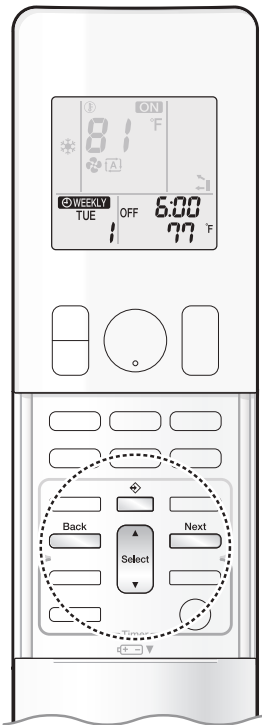

6. Press  to select the desired time.

- The time can be set between 0:00 and 23:50 in 10-minute intervals.
- To return to the ON/OFF TIMER mode setting, press .
- Proceed to **STEP 9** when setting the OFF TIMER.

7. Press .

- The time will be set.
- “ WEEKLY” and the temperature blink.

8. Press  to select the desired temperature.

- The temperature can be set between 50 °F (10.0 °C) and 90 °F (32.0 °C).
COOL or AUTO: The unit operates at 64 °F (18.0 °C) even if it is set at 50 °F (10.0 °C) to 63 °F (17.0 °C).
HEAT or AUTO : The unit operates at 86 °F (30.0 °C) even if it is set at 87 °F (30.5 °C) to 90 °F (32.0 °C).
- To return to the time setting, press .
- The set temperature is only displayed when the mode setting is on.

9. Press .

- The temperature will be set and go to the next reservation setting.
- The temperature is set while in ON TIMER operation, and the time is set while in OFF TIMER operation.
- The next reservation screen will appear.
- To continue further settings, repeat the procedure from **STEP 4**.

10. Press  to complete the setting.

- Be sure to direct the remote controller toward the indoor unit and check for a receiving tone and blinking of the OPERATION lamp.
- “ WEEKLY” is displayed on the LCD and WEEKLY TIMER operation is activated.
- The TIMER lamp lights orange.

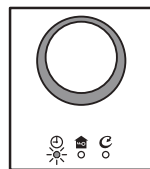



Display

- A reservation made once can be easily copied and the same settings used for another day of the week. Refer to **Copy mode**.

NOTE

Notes on WEEKLY TIMER operation

- Do not forget to set the clock on the remote controller first.
- The day of the week, ON/OFF TIMER mode, time and set temperature (only for ON TIMER mode) can be set with the WEEKLY TIMER. Other settings for the ON TIMER are based on the settings just before the operation.
- WEEKLY TIMER and ON/OFF TIMER operation cannot be used at the same time. The ON/OFF TIMER operation has priority if it is set while WEEKLY TIMER is still active. The WEEKLY TIMER will enter the standby state, and “ WEEKLY” will disappear from the LCD. When the ON/OFF TIMER is up, the WEEKLY TIMER will automatically become active.
- Only the time and set temperature with the WEEKLY TIMER are sent with the . Set the WEEKLY TIMER only after setting the operation mode, the airflow rate and the airflow direction ahead of time.
- Turning off the circuit breaker, power failure, and other similar events will render operation of the indoor unit’s internal clock inaccurate. Reset the clock.
-  can be used only for the time and temperature settings. It cannot be used to go back to the reservation number.

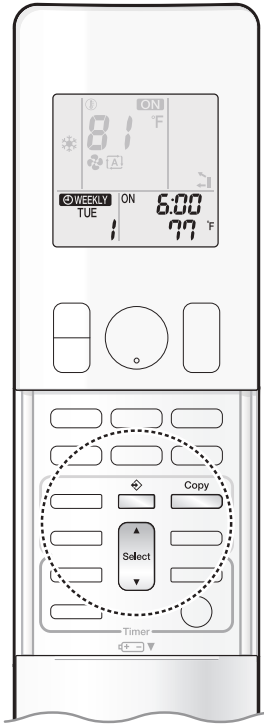

Copy mode

- A reservation made once can be copied to another day of the week. The whole reservation of the selected day of the week will be copied.

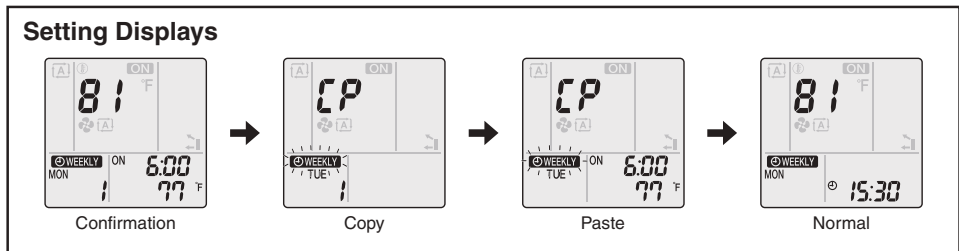
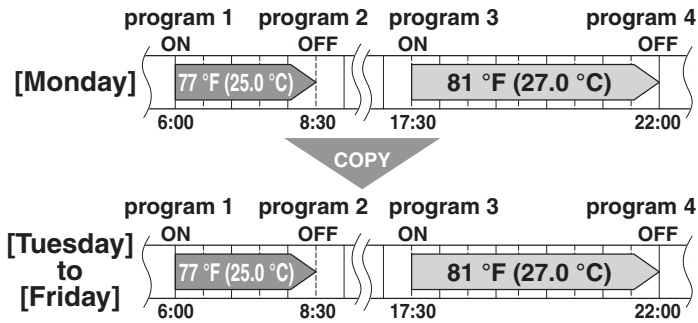

1. Press .
2. Press to confirm the day of the week to be copied.
3. Press .
 - The whole reservation of the selected day of the week will be copied.
4. Press to select the destination day of the week.
5. Press .
 - The reservation will be copied to the selected day of the week. The whole reservation of the selected day of the week will be copied.
 - To continue copying the settings to other days of the week, repeat **STEP 4** and **STEP 5**.
6. Press to complete the setting.
 - “ WEEKLY ” is displayed on the LCD and WEEKLY TIMER operation is activated.

NOTE

Note on COPY MODE

- The entire reservation of the source day of the week is copied in the copy mode.
- In the case of making a reservation change for any day of the week individually after copying the content of weekly reservations, press and change the settings in the steps of **Setting mode** .

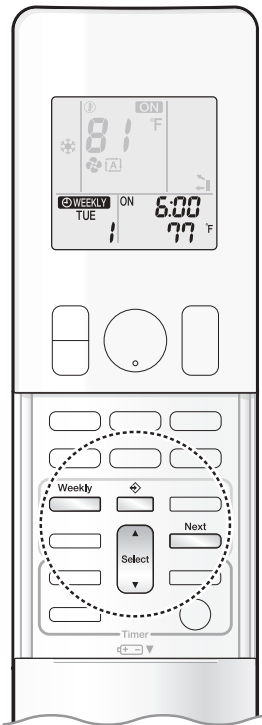

Confirming a reservation

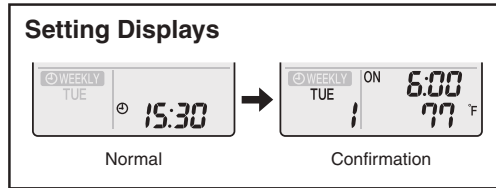

- The reservation can be confirmed.



1. Press .

- The day of the week and the reservation number of the current day will be displayed.

2. Press to select the day of the week and the reservation number to be confirmed.

- Pressing  displays the reservation details.
- To change the confirmed reserved settings, select the reservation number and press  . The mode is switched to setting mode. Proceed to **Setting mode STEP 4.**

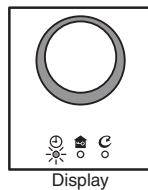

3. Press to exit the confirmation mode.

- “  ” is displayed on the LCD and WEEKLY TIMER operation is activated.
- The TIMER lamp lights orange.



To deactivate WEEKLY TIMER operation

Press while “ ” is displayed on the LCD.

- “  ” disappears from the LCD.
- The TIMER lamp goes off.
- To reactivate the WEEKLY TIMER operation, press  again.
- If a reservation deactivated with  is activated once again, the last reservation mode will be used.

NOTE

- If not all the reservation settings are reflected, deactivate the WEEKLY TIMER operation once. Then press  again to reactivate the WEEKLY TIMER operation.

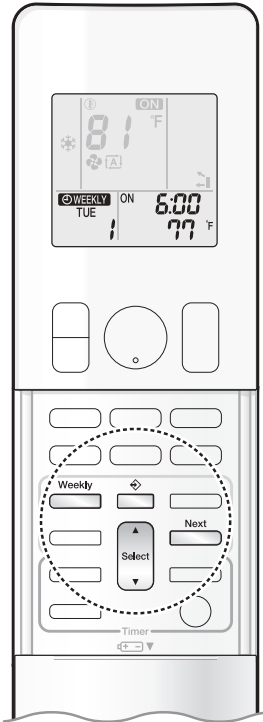

To delete reservations

An individual reservation

1. Press .

- The day of the week and the reservation number will be displayed.

2. Press **to select the day of the week and the reservation number to be deleted.**

3. Press .

- “ WEEKLY” and “ON” or “OFF” blink.

4. Press **until no icon is displayed.**

- Pressing changes the ON/OFF TIMER mode in sequence.
- Selecting “blank” will cancel any reservation you may have.



Pressing puts the sequence in reverse.

5. Press .

- The selected reservation will be deleted.

6. Press .

- If there are still other reservations, WEEKLY TIMER operation will be activated.

Reservations for each day of the week

- This function can be used for deleting reservations for each day of the week.
- It can be used while confirming or setting reservations.

1. Press .

- The day of the week and the reservation number will be displayed.

2. Press **to select the day of the week to be deleted.**

3. Hold **for about 5 seconds.**

- The reservation of the selected day of the week will be deleted.

4. Press .

- If there are still other reservations, WEEKLY TIMER operation will be activated.

All reservations

Hold **for about 5 seconds with the normal display.**

- Be sure to direct the remote controller toward the indoor unit and check for a receiving tone.
- This operation cannot be used for the WEEKLY TIMER setting display.
- All reservations will be deleted.

4.15 Brightness Setting of Indoor Unit Display

Outline

The brightness of the indoor unit display can be adjusted as desired. Also, the display can be turned OFF.

Details

1. Press and hold **Menu** (push 2sec) button for 2 seconds.
LEd appears on the LCD and **1** blinks.
2. Press **Select Up** or **Down** button to select menu number **1**.

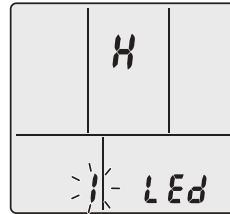

3. Press **Menu** (push 2sec) button to confirm the setting.
4. Press **Select Up** or **Down** button and select the desired brightness as follows:

R4003752

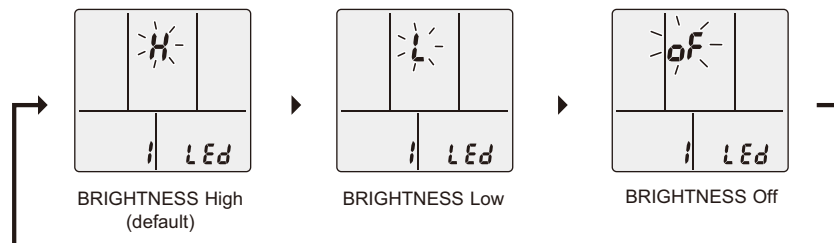

5. Press **Menu** (push 2sec) button again to confirm the setting. Brightness will be set to the chosen value.
6. Press **Cancel** button to return to the default screen.



Note(s)

The display automatically returns to the default screen when the remote controller is left untouched for 60 seconds. To return to the default screen immediately, press **Cancel** button twice.

4.16 CLEAN Operation

Outline

The inside of the air conditioner is dried to reduce the occurrence of mold and odor. When COOL or DRY operation is performed, condensation may occur inside the air conditioner and may cause mold or odor. It is recommended to dry the inside of the air conditioner using CLEAN operation.

Details

■ To operate automatically

1. Press and hold **Menu** (push 2sec) button for 2 seconds.
2. Press **Select Up** or **Down** button to select menu number **4**.
CLEAN icon appears and **4** blinks.
3. Press **Menu** (push 2sec) button to confirm the setting.
4. Press **Select Up** or **Down** button to change the setting as follows:

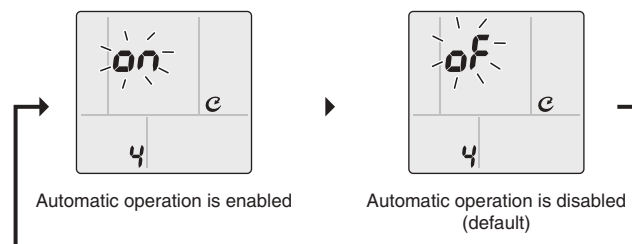

R4004358

5. Press **Menu** (push 2sec) button to confirm the setting.
Automatic CLEAN operation will be enabled or disabled according to the chosen setting. If automatic CLEAN operation is enabled, CLEAN icon appears on the LCD of the remote controller and the CLEAN lamp on the indoor unit lights green when CLEAN operation is in progress.

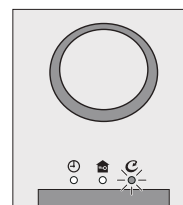

Display

R4004076

6. Press **Cancel** to return to the default screen.



Note(s)

Note on CLEAN setting

The display automatically returns to the default screen when the remote controller is left untouched for 60 seconds. To return to the default screen immediately, press **Cancel** button twice.

Notes on CLEAN operation

- When you want to stop CLEAN operation midway, press **ON/OFF** button twice.
- After DRY or COOL operation stops, the air conditioner starts CLEAN operation automatically, and FAN and HEAT operation will operate for approximately 120 minutes and then stop automatically.
- This operation dries the inside of the air conditioner using FAN operation. The indoor temperature and humidity may not suit your preferences.
- The CLEAN operation dries the interior of the indoor unit to reduce the amount of condensation present.
- CLEAN operation is not available when the unit is turned off using the OFF TIMER or turned off using a smartphone.
- CLEAN operation may not be performed if the COOL or DRY operation time is short.
- If CLEAN operation does not suit your preference, set operation to “**oF**” (Automatic operation is disabled).
- When multiple indoor units are connected, if another indoor unit is in HEAT operation, CLEAN operation will not start or will be interrupted.

Relation between CLEAN operation and indoor unit lamps

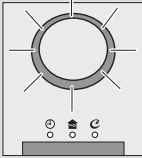
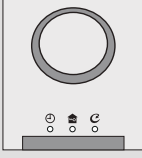
Air conditioner	CLEAN setting	CLEAN lamp	Operation lamp
 <p data-bbox="440 488 643 533">Air conditioner operating (Operation lamp lights up)</p>	CLEAN is "ON"	Lights up (green)	Lights up (color depends on mode setting)
	CLEAN is "OFF"	Goes off	
 <p data-bbox="440 723 643 768">Air conditioner stopped (Operation lamp goes off)</p>	CLEAN is "ON"	Lights up (green)	Goes off

4.17 Wireless LAN Connection

Operation

Wireless LAN connection



Web site: <https://daikinone.com/ductless>

For instructions on how to connect your unit to wireless LAN and to your Daikin One Home application, please see the website above.

Contains FCC ID: VPYLB1YA

This device complies with part 15 of the FCC Rules. Operation is subject to the following two conditions:

- (1) This device may not cause harmful interference, and
- (2) This device must accept any interference received, including interference that may cause undesired operation.

FCC CAUTION

Changes or modifications not expressly approved by the party responsible for compliance could void the user's authority to operate the equipment. This transmitter must not be co-located or operated in conjunction with any other antenna or transmitter.

Contains IC: 772C-LB1YA

This device complies with Industry Canada's applicable licence-exempt RSSs.

Operation is subject to the following two conditions:

- (1) This device may not cause interference; and
- (2) This device must accept any interference, including interference that may cause undesired operation of the device.

This equipment complies with IC radiation exposure limits set forth for an uncontrolled environment and meets RSS-102 of the IC radio frequency (RF) Exposure rules. This equipment should be installed and operated keeping the radiator at least 7-7 / 8 inches (20 cm) or more away from person's body. The FCC responsible party is Daikin Comfort Technologies Manufacturing, L.P., and may be contacted by calling (713)-861-2500, or at 19001 Kermier Rd., Waller, TX 77484.

(<https://www.northamerica-daikin.com>)

This device, which was assembled by Daikin Comfort Technologies Manufacturing, L.P., contains a component that is classified as an intentional radiator.

This intentional radiator has been certified by the FCC: FCC ID VPYLB1YA.

And this intentional radiator has an industry Canada ID: IC 772C-LB1YA.

The manufacturer of the intentional radiator (model no. Type1YA) is Murata Manufacturing co., Ltd (www.murata.com).

This equipment complies with FCC radiation exposure limits set forth for an uncontrolled environment and meets the FCC radio frequency (RF) Exposure Guidelines. This equipment should be installed and operated keeping the radiator at least 7-7 / 8 inches (20 cm) or more away from person's body.

Changes or modifications not expressly approved by the party responsible for compliance could void the user's authority to operate the equipment. NOTE: This equipment has been tested and found to comply with the limits for a Class B digital device, pursuant to part 15 of the FCC Rules.

These limits are designed to provide reasonable protection against harmful interference in a residential installation. This equipment generates, uses and can radiate radio frequency energy and, if not installed and used in accordance with the instructions, may cause harmful interference to radio communications. However, there is no guarantee that interference will not occur in a particular installation. If this equipment does cause harmful interference to radio or television reception, which can be determined by turning the equipment off and on, the user is encouraged to try to correct the interference by one or more of the following measures:

- Reorient or relocate the receiving antenna.
- Increase the separation between the equipment and receiver.
- Connect the equipment into an outlet on a circuit different from that to which the receiver is connected.
- Consult the dealer or an experienced radio / TV technician for help.

Application software installation

For Android Phones

- 1) Open [Google Play].
- 2) Search using the application name:
[Daikin One Home].
- 3) Follow the directions on the screen to install.

For iOS Phones

- 1) Open the [App Store].
- 2) Search using the application name:
[Daikin One Home].
- 3) Follow the directions on the screen to install.

Attention

- The actual application screen layout and content may differ from what is shown. The layout and content of the application screen is subject to change without notice.

Connect the air conditioner to your home network.

1. While operation is stopped, press  and hold the button for 5 seconds.

2. Press  or  and select menu number 3.

- “SP” appears on the LCD.
- “3” blinks.



3. Press  to connect to the access point.

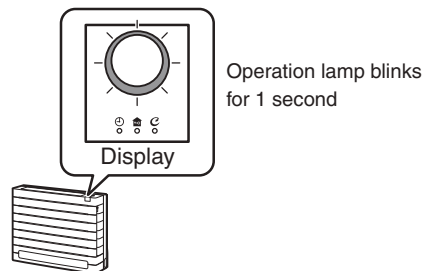

4. Press  to return to the default screen.



No more settings need to be carried out from the remote controller.

5. Open Daikin One Home App and follow the instructions to set up the wireless LAN.

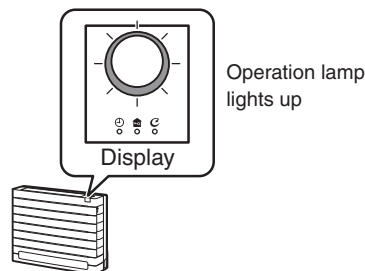
6. When the operation lamp switches from blinking to lit, the connection is complete.



NOTE

- While “SP” is displayed, the options that can be selected using  or  are 1, 3, A, and OFF.
- Perform wireless LAN connection one indoor unit at a time.
- If you are unable to establish a network connection, refer the troubleshooting provided by the Daikin One Home App.
- When the lamp blinks slowly, the connection is not ready. Perform the connection procedure while it blinks quickly.

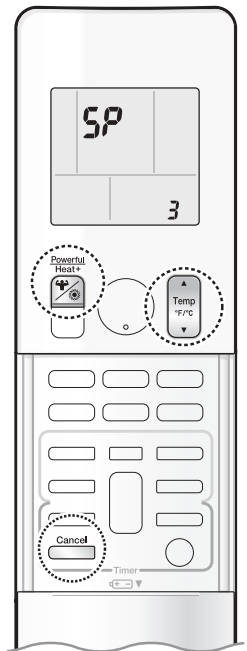

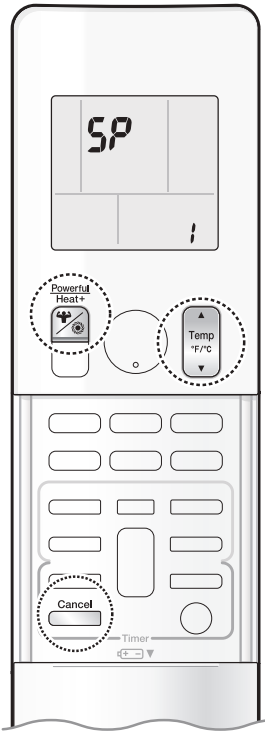

To confirm the wireless LAN connection adapter connection

■ To confirm

1. While operation is stopped, press and hold the button for 5 seconds.

2. Press to confirm the selected setting.

- “SP” appears on the LCD.
- “i” blinks.

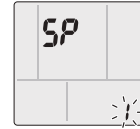

Check the indoor unit LED.

Operation lamp	Status
Blinking for 1 second	Communication is not ready
Blinking for 3 seconds	Please initialize the wireless LAN connection adapter
Does not blink or light	Communication is abnormal There is a possibility of equipment failure Please request repair

To turn off the wireless connection

■ To use the remote controller

1. While operation is stopped, press and hold the button for 5 seconds.

2. Press or and select menu **OFF**.

- “SP” appears on the LCD.
- “OFF” blinks, and communication is OFF.



3. Press and hold the button for 2 seconds to confirm selected setting.

- The operation lamp will turn off.

4. Press to return to the default screen.

To reset the connection setting to the factory default

- If you want to reset the connection settings, it is possible to initialize the wireless LAN connection adapter to its factory default state. If initialized, data including the network settings and power consumption history will be erased.
- When discarding or transferring to another user, initialize the connection adapter to erase the internal data.

■ To reset

1. While operation is stopped, press and hold the button for 5 seconds.

2. Press or and select menu **R**.

- “SP” appears on the LCD.
- “R” blinks.

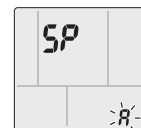

3. Press and hold the button for 2 seconds to confirm selected setting.

- The operation lamp blinks for 1 second.

4. Press to return to the default screen.

NOTE

Note on wireless LAN operation

- If the LED display is distracting, change the brightness setting.

4.18 Other Functions

4.18.1 Hot-Start Function

In order to prevent the cold air blast that normally occurs when heating operation is started, the temperature of the indoor heat exchanger is detected, and the airflow is either stopped or significantly weakened resulting in comfortable heating.



Note(s)

The cold air blast is prevented using similar control when defrost control starts or when the thermostat is turned ON.

4.18.2 Signal Receiving Sign

When the indoor unit receives a signal from the remote controller, the unit emits a signal receiving sound.

4.18.3 Indoor Unit ON/OFF Switch

ON/OFF switch is provided on the display of the unit.

- Press **ON/OFF** switch once to start operation. Press once again to stop it.
- **ON/OFF** switch is useful when the remote controller is missing or the battery has run out.

Operation mode	Temperature setting	Airflow rate
AUTO	25°C (77°F)	Automatic

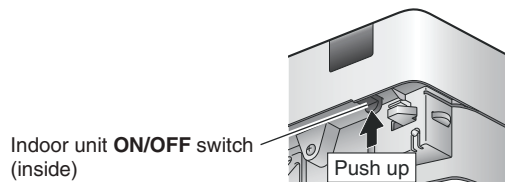

R4004084

Forced Cooling Operation

Forced cooling operation can be started by pressing **ON/OFF** switch for 5 ~ 9 seconds while the unit is not operating.

Refer to page 301 for details.



Note(s)

Forced cooling operation is not started if **ON/OFF** switch is pressed for 10 seconds or more.

4.18.4 Auto-restart Function

If a power failure (even a momentary one) occurs during the operation, the system restarts automatically in the same conditions as before when the power supply is restored to the conditions prior to the power failure.



Note

It takes 3 minutes to restart the operation because 3-minute standby function is activated.

5. Functions for CMXV Series

5.1 Fan Speed Control for Indoor Unit

- **With Daikin One Thermostat**

Refer to the following link for details.

<https://daikincomfort.com/pro>

5.2 Program Dry Operation

Outline Program dry operation removes humidity while keeping cooling to the target temperature.

Details The microcomputer sets the airflow rate at Low speed. The unit keeps cooling the room to the target temperature while maintaining the humidity at a comfortable level.

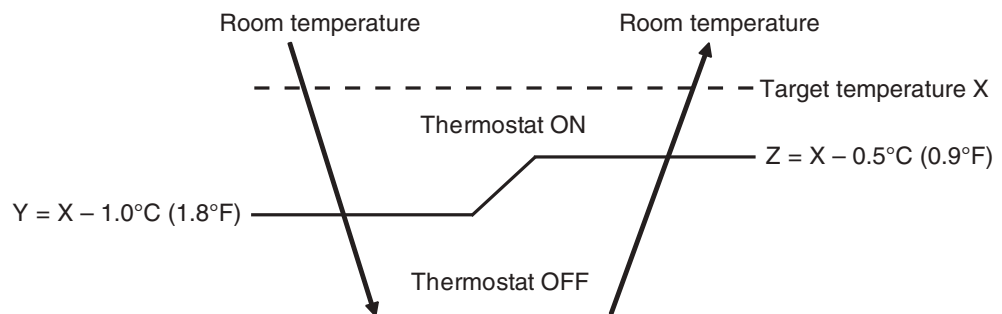

R4004359

Target temperature X	Thermostat OFF point Y	Thermostat ON point Z
Set temperature on thermostat	$X - 1.0^{\circ}\text{C}$ ($X - 1.8^{\circ}\text{F}$)	$X - 0.5^{\circ}\text{C}$ ($X - 0.9^{\circ}\text{F}$)

5.3 Automatic Cooling/Heating Change-over

Outline When the automatic operation is selected with the Daikin One Thermostat, the thermostat automatically determines the operation mode as cooling or heating according to the room temperature and the set temperature at start-up. The unit automatically switches the operation mode to maintain the room temperature at the set temperature.

- **With Daikin One Thermostat**

Daikin One Thermostat has different thermostat ON/OFF point.

Refer to <https://daikincomfort.com/pro>.

5.4 Refrigerant Detection System (RDS) Function

Refrigerant Detection System (RDS) is installed in this equipment to detect any refrigerant leakage in the coil and leak detection sensor failure and conduct safety actions in the following table to mitigate any risk of ignition/fire.

In case that a leak is detected, the safety actions start when a leak is detected by leak detection sensor and continue until 5 minutes elapsed after a leak stops being detected.

In case of leak detection sensor failure, the same safety actions are performed.

Item (function)	Leak actions (*1)
Remote controller	Display of error code A0-17 , A0-19 or CH-11 , CH-14
Fan motor	Run at LL or greater tap
Compressor	OFF
Leak detection output (Relay K6R) (*2)	Energized
Optional Heater Kit	OFF

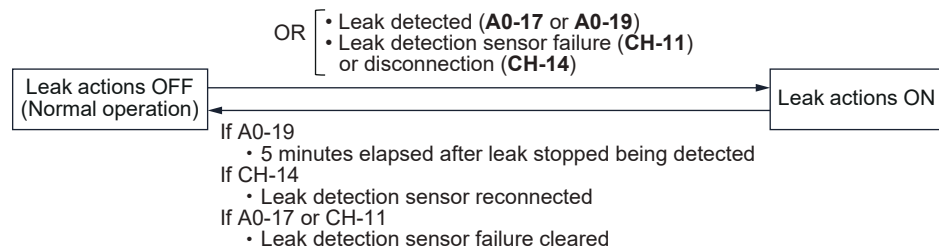

Note(s)

*1. In case of installing a fire alarm to Auxiliary Alarm terminals (TB4 and TB5), it is recommended to change the field setting to stop the indoor unit fan motor when both a refrigerant leak is detected and the fire alarm is activated. Refer to Auxiliary Alarm Switch on page 107 and Error priority setting on page 329.

*2. To comply with the requirements of safety standards, wiring work should be done using this relay to ensure that optional kits and other equipment will operate safely (any accessories that could be a potential ignition source should shut down) in the event that a leak is detected or the leak detection sensor fails. Refer to Leak Detection Output (Relay K6R) on page 104.

5.5 Leak Detection Output (Relay K6R)

PCB is equipped with three Refrigerant Leak Detection terminals (dry contact), labeled TB11, TB12 and TB13. These terminals are used for the control of optional kits (UV light, ventilator and/or any accessories that could be a potential ignition source) when refrigerant leak is detected (error code **A0-17** or **A0-19**) and/or leak detection sensor fails (error code **CH-11** or **CH-14**). TB12-13 are normally closed, and TB11-13 are normally opened. When the **A0-17**, **A0-19**, **CH-11** and/or **CH-14** error code is issued, TB12-13 is open, and TB11-13 is closed. See the following table for the conditions of relay K6R when the error code is issued.

Relay K6R action when **A0-17/A0-19/CH-11/CH-14** is issued

Items	When A0-17/A0-19/CH-11/CH-14 are not issued	When A0-17/A0-19/CH-11/CH-14 are issued
Terminal TB12-TB13 (NC)	CLOSE	OPEN
Terminal TB11-TB13 (NO)	OPEN	CLOSE



Warning

ALL FIELD CONNECTED DEVICES (EXCEPT OPTIONAL ELECTRIC HEATER KITS WHICH ARE CONTROLLED BY THE UNIT'S CONTROL BOARD) THAT MAY BECOME A POTENTIAL IGNITION SOURCE MUST BE CONNECTED TO THE LEAK DETECTION OUTPUT (RELAY: K6R) ON THE MODULAR BLOWER CONTROL BOARD. IF A FIELD DEVICE, SUCH AS AN ELECTRONIC AIR CLEANER, IS ALREADY INSTALLED IN THE DUCT WORK AND CANNOT NOT BE INTERLOCKED WITH LEAK DETECTION OUTPUT, IT MUST BE DISABLED OR REMOVED.

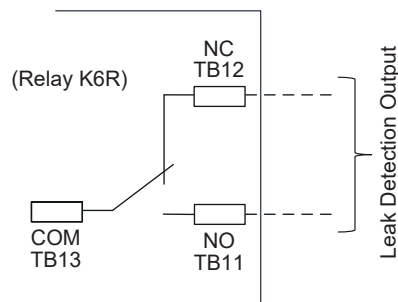

5.6 Accessory Contacts (Humidifier Relay)

A closed relay indicates continuity between the two terminals. The control does not provide power to these contacts (dry contact).

Connect humidistat to the X1M connector on PCB so that the air handler receives the input from humidistat.

Wire Specification	Sheathed Vinyl Cord or Cable (2 wires)
Gauge	AWG 18–16
Length	Max. 328 ft
External Terminal	Contact that can ensure the minimum applicable load of 16 VDC, 1 mA.

The accessory relay terminals support four operational modes below for humidification. Refer to Accessory Contacts on page 329 to choose the setting for accessory contacts.

Selection 0: Heat On

The relay closes when both heating is on and air handler receives an input from X1M.

Selection 1: Independent

The relay closes when air handler receives an input from X1M.

Selection 2: Fan

The relay closes when the indoor unit's fan is operating.

Selection 3: None (factory setting)

The relay remains open; it never closes.

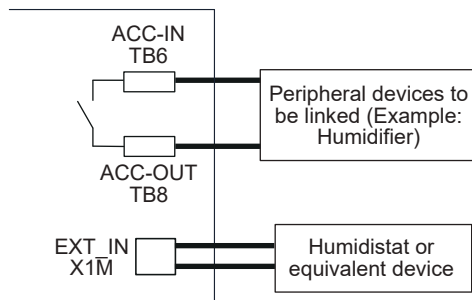

i Note(s)

The Accessory Relay is not forced to open when a refrigerant leak is detected or when a malfunction occurs in the refrigerant leak detection sensor (i.e., when error codes **A0-17**, **A0-19**, **CH-11** or **CH-14** are issued). If it is necessary to enable the Accessory Relay to open while the above error codes are issued, the following wiring connection between the Accessory Relay and Leak Detection Output (relay K6R) can be implemented. The wire harness between ACC-OUT (TB8) and COM (TB12) must be prepared separately at the field.

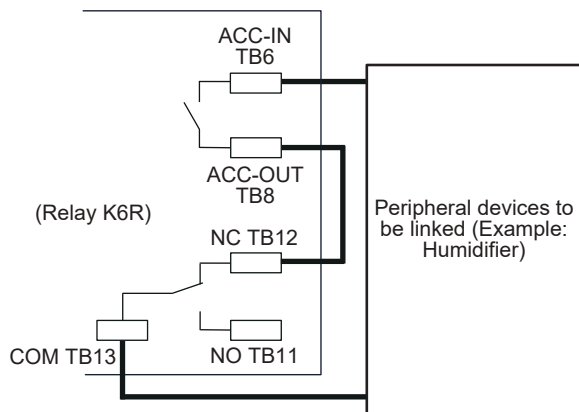

5.7 Electric Heater Control

If heating is insufficient in heat pump system alone, an electric heater is to be used as the auxiliary heater. The following shows the ON/OFF conditions for the electric heater. Optional heater kit HKTS... is required for this control.

Each time the heater kit turns off, the fan off-delay control is activated, keeping the indoor unit fan running for 90 seconds. (Refer to Fan Off-delay Control (CMXV Model) on page 107.)

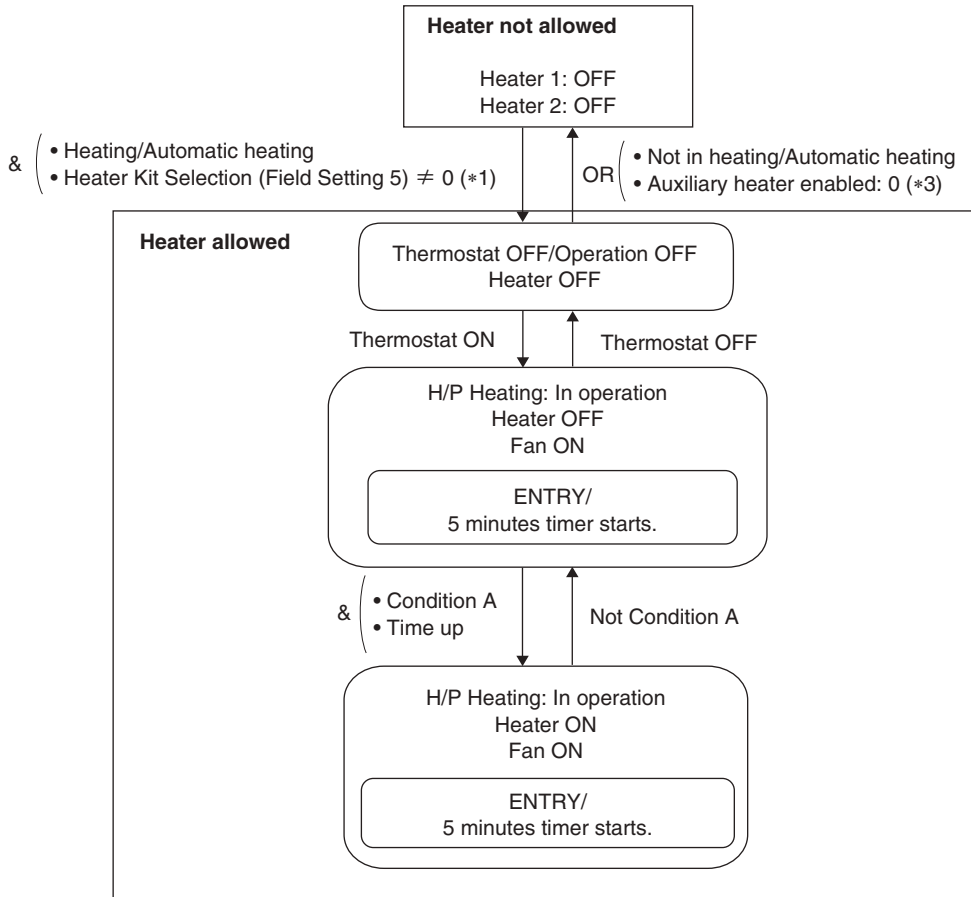

Condition A

- Heater condition: ON (*2)
- No fan motor error
- No thermistor/pressure sensor error
- Coil temperature condition: ON (*3)
- Not in defrost control
- Not in hot start

i Note(s)

- *1: Heater Kit Selection (Field Setting 5)
Refer to Heater Kit Selection on page 329.
- *2: Heater condition

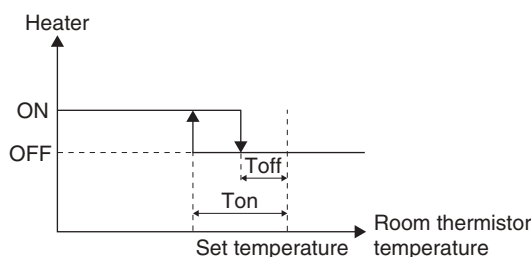

- *3. Coil temperature condition

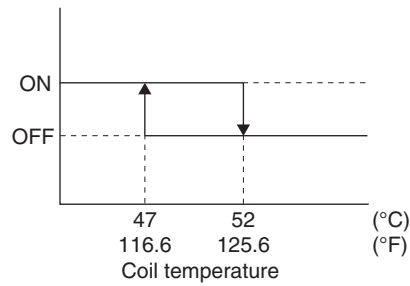

5.8 Fan Off-delay Control

Outline

If the indoor heater turned OFF from ON during heating operation, the fan will keep operating for further period of time in order to cool the heater.

Detail

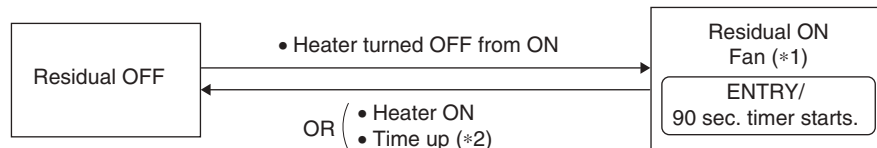

- *1. When the heater is ON, the airflow rate of the fan will be whichever is the largest between the CFM dictated by the heater's own capacity, or the fan tap CFM determined by other controls.
- *2. Fan residual operation will continue, even if the indoor unit is turned off with the remote controller operation button.

5.9 Auxiliary Alarm Switch

The control is equipped with two Auxiliary Alarm terminals, labeled TB4 and TB5 (2 VA or less) which are typically utilized in series with a condensate switch. The auxiliary alarm switch must be normally closed and open when the alarm occurs. For example, a normally closed condensate switch will open when the base pan's water level reaches a particular level. The control will respond by turning off the blower motor and displaying the proper fault codes. If the switch is later detected closed, normal operation resumes and the error message is removed. (The switch is closed as part of the default factory setting.) The error (A0-01) will be maintained in the equipment's fault history.

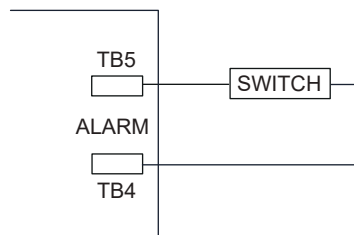

i Note(s)

In case of installing a fire alarm to Auxiliary Alarm terminals (TB4 and TB5), it is recommended to change the field setting to stop the indoor unit fan motor when both a refrigerant leak is detected and the fire alarm is activated. Refer to Error priority setting on page 329.

5.10 Freeze-up Protection Control

Details

When the freeze-up protection control starts, the compressor stops, the airflow rate is fixed to L tap, and the drain pump turns ON. Conditions for starting and ending are as below.

Starting conditions

The freeze-up protection control starts when any of the following conditions is satisfied.

- The indoor heat exchanger temperature remains at **A** or lower for 1 minute.
- The accumulated time that the indoor heat exchanger temperature remains at **B** or lower reaches 40 minutes.

Accumulated timer clearing condition

- The indoor heat exchanger temperature remains at **C** or higher for 20 minutes.

Ending condition

- The indoor heat exchanger temperature remains at **D** or higher for 10 minutes.

	(°C)	(°F)
A	-5	23.0
B	-1	30.2
C	4	39.2
D	7	44.6

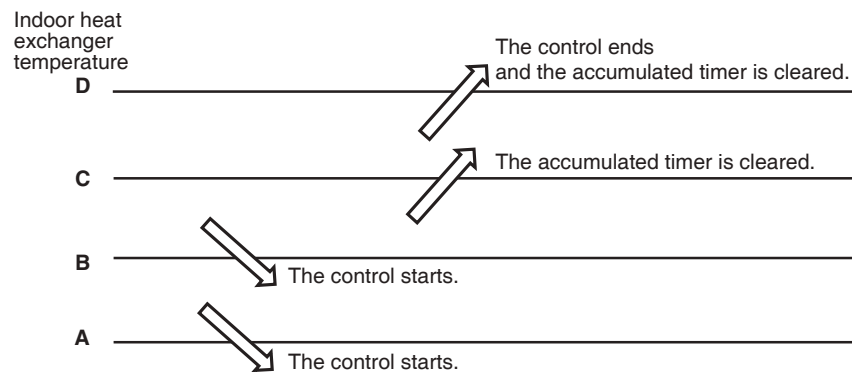

R4003915

6. Control Specification

6.1 Thermistor Functions

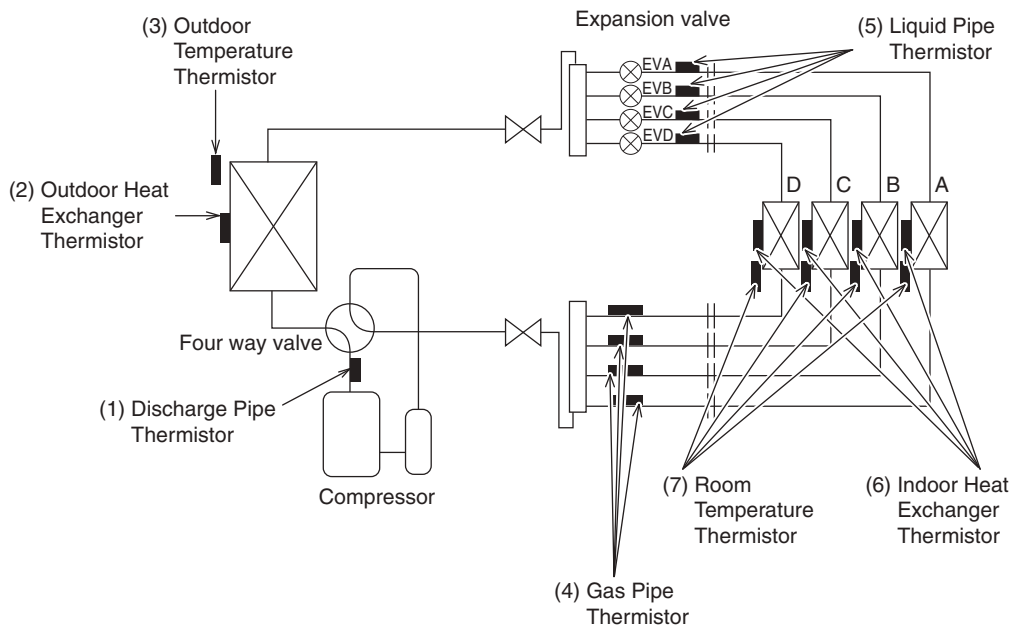

R4004138

The illustration is for the 4-room models as representative and have 4 lines of indoor unit system (A ~ D).

Each system has respective number of lines according to the specified number of the rooms.

(1) Discharge Pipe Thermistor

- The discharge pipe thermistor is used for controlling discharge pipe temperature. If the discharge pipe temperature (used in place of the inner temperature of the compressor) rises abnormally, the operating compressor speed becomes lower or the operation halts.
- The discharge pipe thermistor is used for detecting disconnection of the discharge pipe thermistor.

(2) Outdoor Heat Exchanger Thermistor

- The outdoor heat exchanger thermistor is used for controlling the target discharge pipe temperature. The system sets the target discharge pipe temperature according to the outdoor and indoor heat exchanger temperature, and controls the electronic expansion valve opening so that the target discharge pipe temperature can be obtained.
- In cooling operation, the outdoor heat exchanger thermistor is used for detecting the disconnection of the discharge pipe thermistor. When the discharge pipe temperature drops below the outdoor heat exchanger temperature by more than a certain value, the discharge pipe thermistor is judged as disconnected.
- In cooling operation, the outdoor heat exchanger thermistor is used for high pressure protection.

(3) Outdoor Temperature Thermistor

- The outdoor temperature thermistor detects the outdoor air temperature and is used for refrigerant shortage detection, input current control, outdoor fan control, liquid compression protection function, and so on.

(4) Gas Pipe Thermistor

- In cooling operation, the gas pipe thermistor is used for gas pipe isothermal control. The system controls electronic expansion valve opening so that the gas pipe temperature in each room becomes equal.

(5) Liquid Pipe Thermistor

- Liquid pipe thermistor is used to protect the compressor against liquid attack during cooling operation.
- In case of low outdoor temperature operation, the system compares the indoor heat exchanger temperature with the liquid pipe temperature to detect disturbances in the refrigerant flow. If any, the system adjusts the opening of the electronic expansion valve to control the refrigerant flow.

- When only one indoor unit is in heating operation, the liquid pipe thermistor is used for subcooling control. The actual subcool is calculated with the liquid pipe temperature and the maximum indoor heat exchanger temperature. The system controls the electronic expansion valve openings to obtain the target subcool.
- In heating operation, the liquid pipe thermistor is used for liquid pipe isothermal control. The system controls the electronic expansion valve opening so that the liquid pipe temperatures in each room becomes equal.

(6) Indoor Heat Exchanger Thermistor

- The indoor heat exchanger thermistor is used for controlling the target discharge pipe temperature. The system sets the target discharge pipe temperature according to the outdoor and indoor heat exchanger temperature, and controls the electronic expansion valve opening so that the target discharge pipe temperature can be obtained.
- In cooling operation, the indoor heat exchanger thermistor is used for freeze-up protection control. If the indoor heat exchanger temperature drops abnormally, the operating compressor speed becomes lower or the operation halts.
- In cooling operation, the indoor heat exchanger thermistor is used for anti-icing function. If any of the following conditions are met in the room where operation halts, it is assumed as icing.
The conditions are
 $T_c \leq -1^\circ\text{C}$ (30.2°F)
 $T_a - T_c \geq 10^\circ\text{C}$ (18°F)
 where T_a is the room temperature and T_c is the indoor heat exchanger temperature.
- The indoor heat exchanger thermistor is used for wiring error check function. The refrigerant flows in order from the port A to detect the indoor heat exchanger temperature one by one, and then wiring and piping can be checked.
- In heating operation, the indoor heat exchanger thermistor is used for heating peak-cut control. If the indoor heat exchanger temperature rises abnormally, the operating compressor speed becomes lower or the operation halts.
- In heating operation, the indoor heat exchanger thermistor is used for detecting the disconnection of the discharge pipe thermistor. When the discharge pipe temperature drops below the highest indoor heat exchanger temperature by more than a certain value, the discharge pipe thermistor is judged as disconnected.
- Excluding the case that all the indoor units are in heating operation, the indoor heat exchanger thermistor is used for subcooling control. The actual subcool is calculated with the liquid pipe temperature and the indoor heat exchanger temperature. The system controls the electronic expansion valve openings to obtain the target subcool.

(7) Room Temperature Thermistor

- The room temperature thermistor detects the room air temperature and is used for controlling the room air temperature.

6.2 Mode Hierarchy

Outline

The air conditioner control has normal operation mode, forced operation mode, and power transistor test mode for installation and servicing.

Details

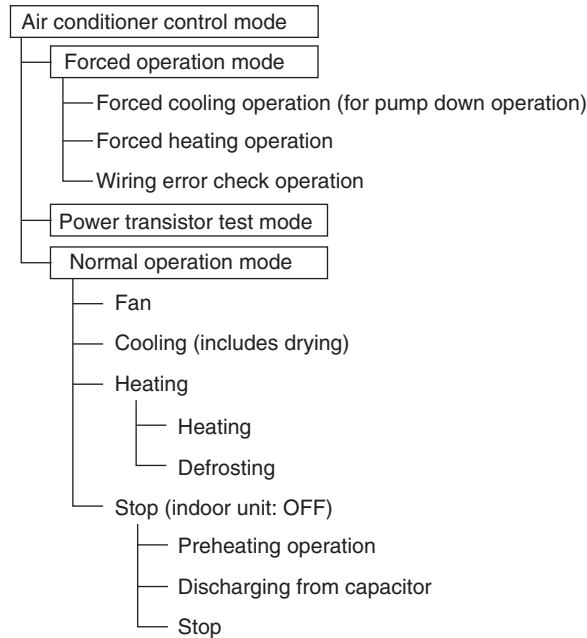

(R17361)

- Unless specified otherwise, dry operation command is regarded as cooling operation.
- Indoor fan operation cannot be made in multiple indoor units. (A forced fan command is made during forced cooling operation.)

Determine Operation Mode

The system judges the operation mode command which is set by each room in accordance with the procedure, and determines the operation mode of the system.

The following procedure is taken when the modes conflict with each other.

*1. The system follows the mode which is set first. (First-push, first-set)

*2. For the rooms where the different mode is set, standby mode is activated. (The operation lamp blinks.)

6.3 Compressor Speed Control

Outline

Compressor speed corresponding to each room’s capacity is determined according to the difference between the target temperature and the temperature of each room.

When the shift of the compressor speed is less than zero ($\Delta F < 0$) by PI control, the target compressor speed is used as the command compressor speed.

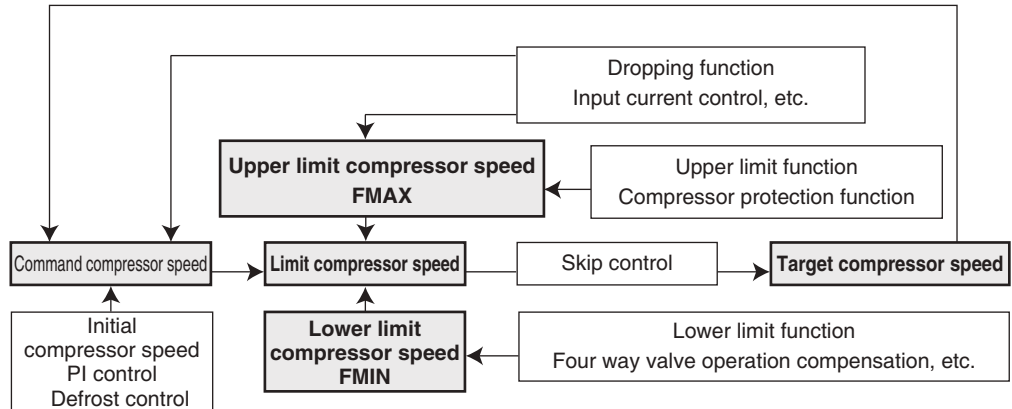

R4004268

Details

The compressor speed is determined by taking the following steps.

1. Determine command compressor speed

Command compressor speed is determined in the following order of priority.

- (1) Limiting defrost control time
- (2) Forced cooling/heating
- (3) Indoor compressor speed command

2. Determine upper limit compressor speed

The minimum value is set as the upper limit compressor speed among the compressor speed upper limits of the following functions:

Compressor protection, input current, discharge pipe temperature, low compressor speed high pressure limit, heating peak-cut, freeze-up protection, defrost.

3. Determine lower limit compressor speed

The maximum value is set as the lower limit compressor speed among the compressor speed lower limits of the following function:

Four way valve operation compensation, draft prevention, pressure difference upkeep.

4. Determine prohibited compressor speed

There is a certain prohibited compressor speed such as a power supply compressor speed.

Parameters

Q value

Indoor unit output determined from indoor unit volume, airflow rate and other factors.

S value: Indoor Unit Capacity

S value is the capacity of the indoor unit, and is used for compressor speed command.

Ex:

Capacity	S value	Capacity	S value
7 kBtu/h	20	15 kBtu/h	50
9 kBtu/h	25	18 kBtu/h	60
12 kBtu/h	35	24 kBtu/h	71

ΔD signal: Indoor compressor speed command

The difference between the room thermistor temperature and the target temperature is taken as the ΔD value and is used for ΔD signal of compressor speed command.

Temperature difference	ΔD signal	Temperature difference	ΔD signal	Temperature difference	ΔD signal	Temperature difference	ΔD signal
-1.0°C (-1.8°F)	*OFF	0°C (0°F)	4	2.0°C (3.6°F)	8	4.0°C (7.2°F)	12
-0.75°C (-1.4°F)	1	0.5°C (0.9°F)	5	2.5°C (4.5°F)	9	4.5°C (8.1°F)	13
-0.5°C (-0.9°F)	2	1.0°C (1.8°F)	6	3.0°C (5.4°F)	10	5.0°C (9.0°F)	14
-0.25°C (-0.5°F)	3	1.5°C (2.7°F)	7	3.5°C (6.3°F)	11	5.5°C (9.9°F)	15

Values depend on the type of indoor unit.

* OFF = Thermostat OFF

Initial Compressor Speed

When starting the compressor, or when conditions are varied due to a change of operating rooms, the compressor speed must be initialized according to a total of the maximum ΔD value of each room and a total Q value (ΣQ) of the operating room (the room in which the thermostat is set to ON).

PI Control

1. P control

Max ΔD value is calculated in each sampling time (15 seconds), and the compressor speed is adjusted according to its difference from the compressor speed previously calculated.

2. I control

If the operating compressor speed does not change for more than a certain fixed time, the compressor speed is adjusted according to max ΔD value.

When max ΔD value is low, the compressor speed is lowered.

When max ΔD value is high, the compressor speed is increased.

3. Compressor speed control when other controls are functioning

- When compressor speed is dropping:
Compressor speed control is carried out only when the compressor speed drops.
- For limiting lower limit:
Compressor speed control is carried out only when the compressor speed rises.

4. Upper and lower limit of compressor speed by PI control

The compressor speed upper and lower limits are set according to the total of S values.

When the indoor unit quiet operation commands come from all the rooms or when the outdoor unit quiet operation commands come from all the rooms, the upper limit compressor speed is lower than the usual setting.

6.4 Controls at Mode Changing/Start-up

6.4.1 Preheating Control

Outline The inverter operation in open phase starts with the conditions of the outdoor temperature and the preheating command from the indoor unit.

Details

ON Condition

- When the outdoor temperature is below **A**, the inverter operation in open phase starts.

OFF Condition

- When the outdoor temperature is higher than **B**, the inverter operation in open phase stops.

	2/3/4MXM 2MXT(H)		5MXM 3/4/5MXT(H)	
	°C	°F	°C	°F
A	5	41	20	68
B	7	44.6	21.5	70.7

6.4.2 Four Way Valve Switching

Outline The four way valve coil is energized/not energized depending on the operation mode (Heating: ON, Cooling/Dry/Defrost: OFF).
In order to eliminate the switching sound as the four way valve coil switches from ON to OFF when the heating is stopped, the OFF delay switch of the four way valve is carried out.

Details

OFF delay switch of four way valve

The four way valve coil is energized for 150 seconds after the operation is stopped.

6.4.3 Four Way Valve Operation Compensation

Outline At the beginning of operation as the four way valve is switched, the pressure difference to activate the four way valve is acquired when the output compressor speed is higher than a certain fixed compressor speed, for a certain fixed time.

Details

Starting Conditions

- The compressor starts and the four way valve switches from OFF to ON
 - The four way valve switches from ON to OFF during operation
 - The compressor starts after resetting
 - The compressor starts after the fault of four way valve switching
- The lower limit of compressor speed keeps **A** rps for 70 seconds for any of the conditions above.

		2MXM	3/4MXM	2MXT(H)	5MXM	3/4/5MXT(H)
A (rps)	Cooling	48	27	27	32	32
	Heating	48	27	27	26	26

6.4.4 3-Minute Standby

Turning on the compressor is prohibited for 3 minutes after turning off.
The function is not used when defrosting.

6.4.5 Compressor Protection Function

When turning the compressor from OFF to ON, the upper limit of compressor speed is set as follows.

The function is not used when defrosting.

■ 2/3/4MXM, 2MXT(H)

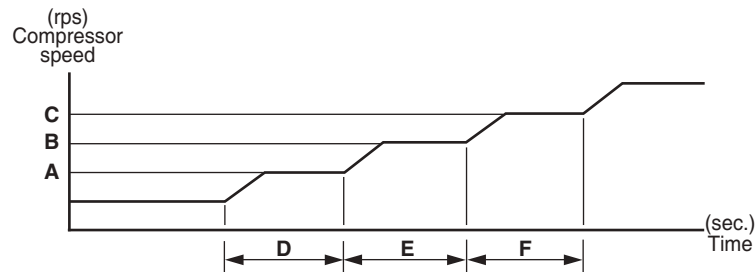

R4004139

	2MXM	3/4MXM	2MXT(H)
A (rpm)	55	35	35
B (rpm)	70	65	65
C (rpm)	85	80	80
D (seconds)	150	100	100
E (seconds)	180	500	500
F (seconds)	300	200	200

■ 5MXM, 3/4/5MXT(H)

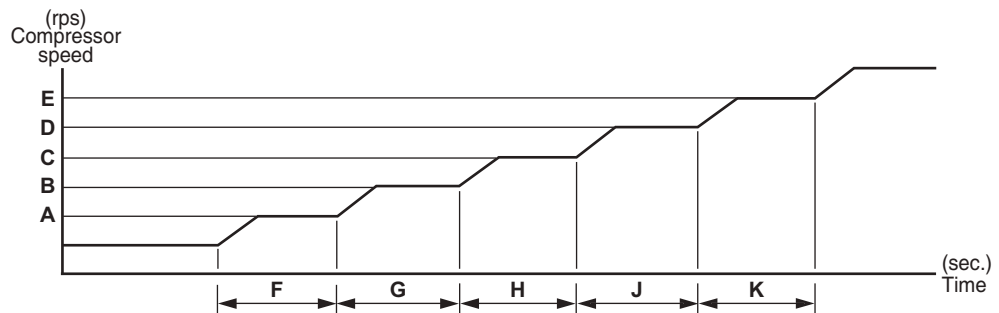

R4004266

	5MXM, 3/4/5MXT(H)	
	Cooling	Heating
A (rpm)	35	23 ~ 52
B (rpm)	48	30 ~ 48
C (rpm)	65	48 ~ 65
D (rpm)	83	65 ~ 83
E (rpm)	95	83 ~ 95
F (seconds)	120	40 ~ 120
G (seconds)	270 ~ 420	240 ~ 420
H (seconds)	290 ~ 450	180 ~ 450
J (seconds)	170 ~ 250	170 ~ 450
K (seconds)	150 ~ 220	150 ~ 220

6.5 Discharge Pipe Temperature Control

Outline

The discharge pipe temperature is used as the internal temperature of the compressor. If the discharge pipe temperature rises above a certain level, the upper limit of compressor speed is set to keep the discharge pipe temperature from rising further.

Details

Zone	Control
Stop zone	When the temperature reaches the stop zone, the compressor stops.
Dropping zone	The upper limit of compressor speed decreases.
Keep zone	The upper limit of compressor speed is kept.
Reset zone	The upper limit of compressor speed is canceled.

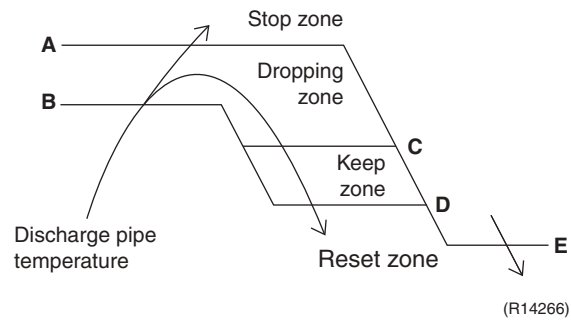

	°C	°F
A	120	248
B	111	231.8
C	109	228.2
D	107	224.6
E	107	224.6

6.6 Input Current Control

Outline

The microcomputer calculates the input current while the compressor is running, and sets the compressor speed upper limit based on the input current. In case of heat pump models, this control is the upper limit control of the compressor speed and takes priority over the lower limit control of four way valve operation compensation.

Details

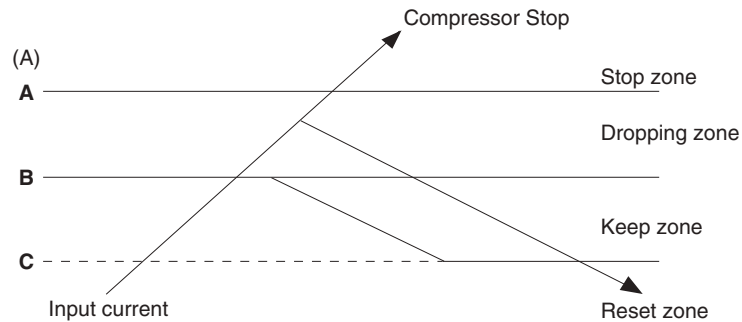

(R23249)

Compressor speed control in each zone

Stop zone

- After the input current remains in the stop zone for 2.5 seconds, the compressor is stopped.

Dropping zone

- The upper limit of the compressor speed is defined as operation compressor speed – 2 rps.
- After this, the output compressor speed is lowered by 2 rps every second until it reaches the keep zone.

Keep zone

- The present maximum compressor speed goes on.

Reset zone

- Limit of the compressor speed is canceled.

	2MXM		3MXM		4MXM		5MXM	
	Cooling	Heating	Cooling	Heating	Cooling	Heating	Cooling	Heating
A (A)	13.0	15.0	19.0	19.0	19.0	19.5	27.5	29.0
B (A)	11.5	14.0	16.0	17.0	17.0	18.5	25.5	27.0
C (A)	10.5	13.0	15.0	16.0	16.0	17.5	24.5	26.0

	2MXT(H)		3MXT(H)		4MXT(H)		5MXT(H)	
	Cooling	Heating	Cooling	Heating	Cooling	Heating	Cooling	Heating
A (A)	19.0	19.0	27.0	27.0	27.5	29.0	27.5	29.0
B (A)	14.0	17.0	25.0	25.0	25.5	27.0	25.5	27.0
C (A)	13.0	16.0	24.0	24.0	24.5	26.0	24.5	26.0

Limitation of current dropping and stop value according to the outdoor temperature

- ◆ The current drops when outdoor temperature becomes higher than a certain level (depending on the model).

6.7 Freeze-up Protection Control

Outline

During cooling operation, the signal sent from the indoor unit determines the compressor speed upper limit and prevents freezing of the indoor heat exchanger. The signals from the indoor unit are divided into zones.

Details

The operating compressor speed limitation is judged with the indoor heat exchanger temperature.

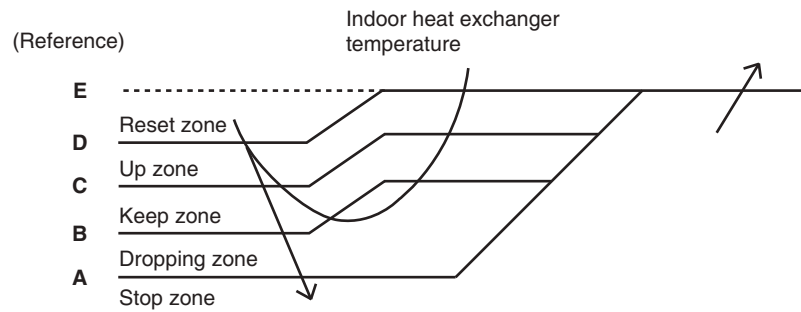

R4003891

	°C	°F
A	0	32
B	3	37.4
C	3.5	38.3
D	4	39.2
E	13	55.4

6.8 Heating Peak-cut Control

Outline

During heating operation, the indoor heat exchanger temperature determines the compressor speed upper limit to prevent abnormal high pressure.

Details

- The operating compressor speed is judged with the indoor heat exchanger temperature 2 minutes after the operation starts and **F** seconds after the number of the rooms in operation is changed.
- The maximum value of the indoor heat exchanger temperature controls the following (excluding the rooms not in operation).

Zone	Control
Stop zone	When the temperature reaches the stop zone, the compressor stops.
Dropping zone	The upper limit of compressor speed decreases.
Keep zone	The upper limit of compressor speed is kept.
Up zone	The upper limit of compressor speed increases.
Reset zone	The upper limit of compressor speed is canceled.

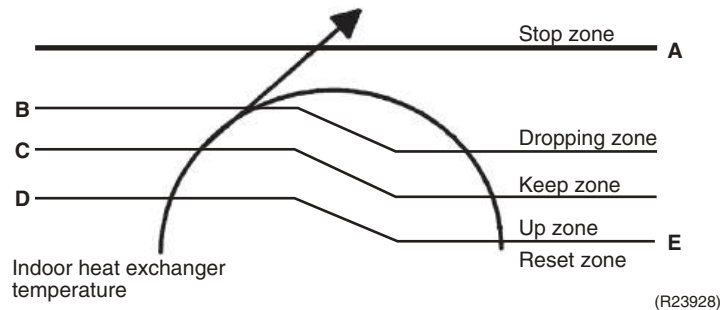

	2/3/4MXM 2MXT(H)		5MXM 3/4/5MXT(H)	
	°C	°F	°C	°F
A	59	138.2	59	138.2
B	55	131	54	129.2
C	54	129.2	53	127.4
D	52	125.6	51	123.8
E	50	122	49	120.2

		All outdoor units
F (seconds)	When increasing	30
	When decreasing	2

6.9 High Pressure Protection Control

Outline

In order to prevent abnormal high pressures in the system and hence avoiding activation of the high pressure safety device the below control function will be activated.

Details

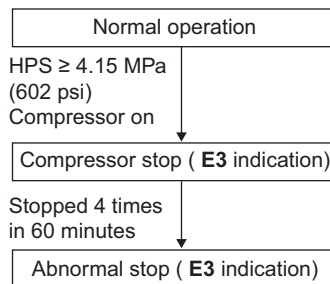
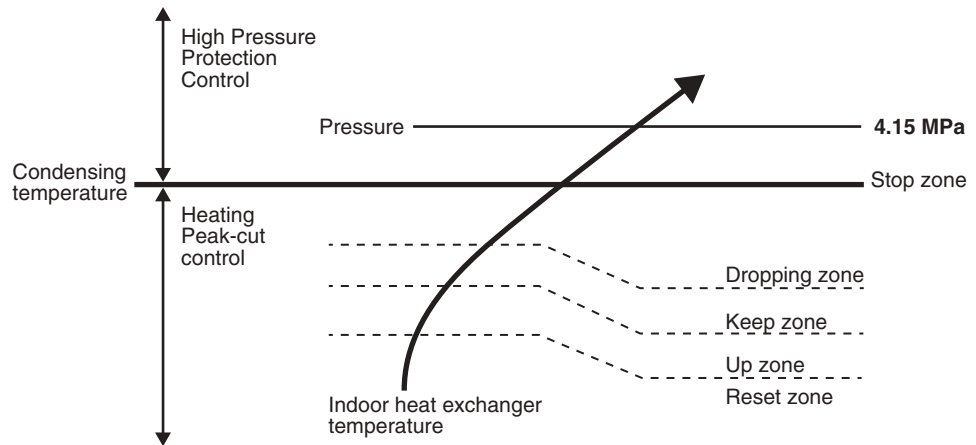

6.10 Outdoor Fan Control

1. **Fan OFF control during defrosting**
The outdoor fan is turned OFF while defrosting.
2. **Fan OFF delay when stopped**
The outdoor fan is turned OFF 60 seconds after the compressor stops.
3. **Fan speed control for pressure difference upkeep**
The rotation speed of the outdoor fan is controlled for keeping the pressure difference during cooling operation with low outdoor temperature.
 - When the pressure difference is low, the rotation speed of the outdoor fan is reduced.
 - When the pressure difference is high, the rotation speed of the outdoor fan is controlled as well as normal operation.
4. **Fan control when the number of heating room decreases**
When the outdoor temperature is more than 10°C (50°F), the fan is turned off for 30 seconds.
5. **Fan speed control during forced cooling operation**
The outdoor fan is controlled as well as normal operation during forced cooling operation.
6. **Fan speed control for POWERFUL operation**
The rotation speed of the outdoor fan is increased during POWERFUL operation.
7. **Fan speed control during indoor/outdoor unit quiet operation**
The rotation speed of the outdoor fan is reduced by the command of the indoor/outdoor unit quiet operation.
8. **Fan ON/OFF control when operation (cooling, heating, dry) starts/stops**
The outdoor fan is turned ON when the operation starts. The outdoor fan is turned OFF when the operation stops.

6.11 Liquid Compression Protection Function

Outline	The compressor stops according to the outdoor temperature for protection.
Details	Operation stops depending on the outdoor temperature. The compressor turns off under the conditions that the system is in cooling operation and the outdoor temperature is below -12°C (10.4°F).

6.12 Defrost Control

Outline	Defrosting is carried out by the cooling cycle (reverse cycle). The defrosting time or outdoor heat exchanger temperature must be more than a certain value to finish defrosting.
Details	<p>Conditions for Starting Defrost</p> <ul style="list-style-type: none"> ■ The starting conditions are determined with the outdoor temperature and the outdoor heat exchanger temperature. (For details, refer to the table on the follow pages. (P. 123, 124, 125)) ■ The system is in heating operation. ■ The compressor operates for 6 minutes. ■ More than A minutes of accumulated time have passed after the start of the operation or ending the previous defrosting. ■ Furthermore, even if the above conditions are not met, if heating operation accumulates for approximately S hours under conditions where the outdoor temperature is below T °C and the outdoor heat exchanger temperature is below U °C, the system starts defrosting.

Conditions for Canceling Defrost

The judgment is made with the outdoor heat exchanger temperature. (B°C (C°F))

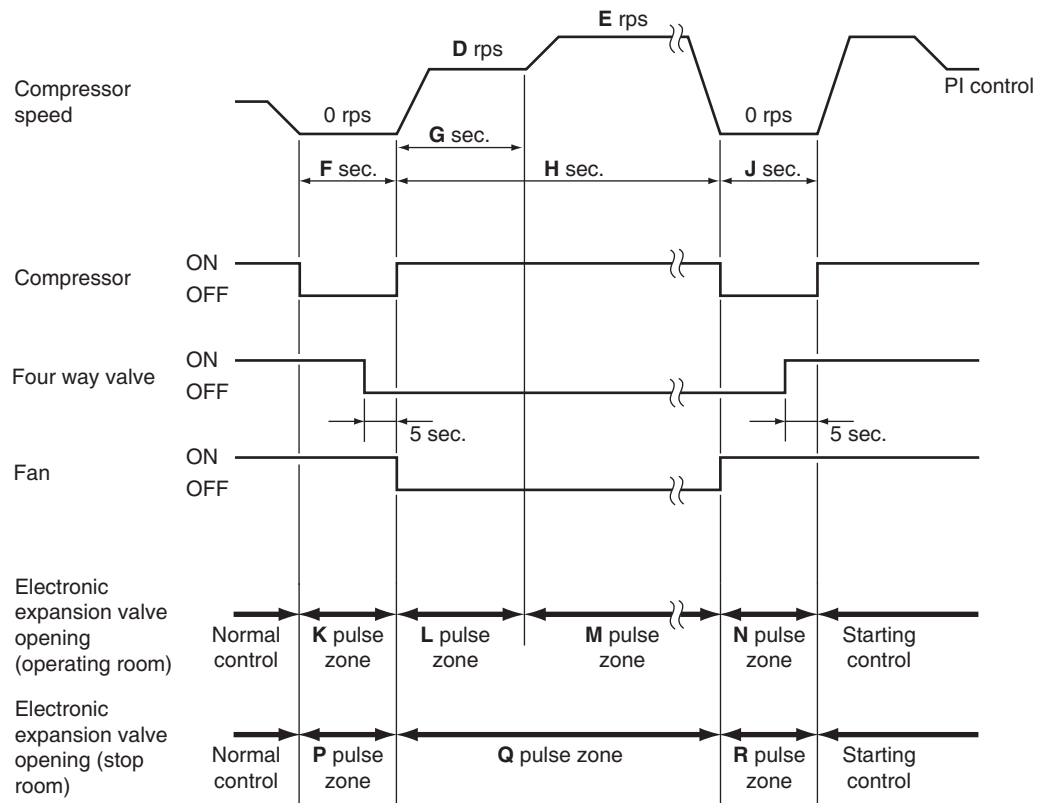

R4004140

	2MXM	3/4MXM	5MXM	2MXT(H)	3/4/5MXT(H)
A (minutes)	33	26	30	26	30
B (°C)	4 ~ 12	4 ~ 12	4 ~ 12	4 ~ 12	4 ~ 12
C (°F)	39.2 ~ 53.6	39.2 ~ 53.6	39.2 ~ 53.6	39.2 ~ 53.6	39.2 ~ 53.6
D (rps)	54	39	45	39	45
E (rps)	79	63	72	63	72
F (seconds)	90	60	60	60	60
G (seconds)	120	120	120	120	120
H (seconds)	530	530	530	530	530
J (seconds)	60	60	60	60	60
K (pulse)	480	480	480	480	480
L (pulse)	250	400	480	400	480
M (pulse)	300	400	480	400	480
N (pulse)	300	400	480	400	480
P (pulse)	160	160	240	160	240
Q (pulse)	50	50	190	50	190
R (pulse)	50	0	240	0	240
S (hours)	6	6	12	6	12
T (°C)	0	0	2	0	2
U (°C)	0	0	0	0	0

2MXM

Outdoor heat exchanger temperature of Defrost **IN**

Compressor speed [rps]	Outdoor temperature (°F)					
	5.0	14.0	19.4	32.0	35.6	44.6
6	3.5	10.1	14.1	23.3	26.0	28.4
8	3.3	9.9	13.9	23.1	25.8	28.4
10	3.1	9.7	13.7	22.9	25.6	28.4
12	2.9	9.5	13.5	22.7	25.4	28.4
14	2.7	9.3	13.3	22.5	25.2	28.4
16	2.5	9.1	13.1	22.3	25.0	28.4
18	2.3	8.9	12.9	22.1	24.8	28.4
20	2.1	8.7	12.7	21.9	24.6	28.4
22	1.9	8.5	12.5	21.7	24.4	28.4
24	1.7	8.3	12.3	21.5	24.2	28.4
26	1.5	8.1	12.1	21.3	24.0	28.4
28	1.3	7.9	11.9	21.1	23.8	28.4
30	1.1	7.7	11.7	20.9	23.6	28.4
32	0.9	7.5	11.5	20.8	23.4	28.4
34	0.7	7.3	11.3	20.6	23.2	28.4
36	0.5	7.1	11.1	20.4	23.0	28.4
38	0.3	6.9	10.9	20.2	22.8	28.4
40	0.1	6.7	10.7	20.0	22.6	28.4
42	-0.1	6.5	10.5	19.8	22.4	28.4
44	-0.3	6.4	10.3	19.6	22.2	28.4
46	-0.5	6.2	10.1	19.4	22.0	28.4
48	-0.7	6.0	9.9	19.2	21.8	28.4
50	-0.9	5.8	9.7	19.0	21.6	28.2
52	-1.0	5.6	9.5	18.8	21.4	28.0
54	-1.2	5.4	9.3	18.6	21.2	27.8
56	-1.4	5.2	9.1	18.4	21.0	27.6
58	-1.6	5.0	8.9	18.2	20.8	27.4
60	-1.8	4.8	8.7	18.0	20.6	27.2
62	-2.0	4.6	8.5	17.8	20.4	27.1
64	-2.2	4.4	8.3	17.6	20.2	26.9
66	-2.4	4.2	8.2	17.4	20.0	26.7
68	-2.6	4.0	8.0	17.2	19.9	26.5
70	-2.8	3.8	7.8	17.0	19.7	26.3
72	-3.0	3.6	7.6	16.8	19.5	26.1
74	-3.2	3.4	7.4	16.6	19.3	25.9
76	-3.4	3.2	7.2	16.4	19.1	25.7
78	-3.6	3.0	7.0	16.2	18.9	25.5
80	-3.8	2.8	6.8	16.0	18.7	25.3
82	-4.0	2.6	6.6	15.8	18.5	25.1
84	-4.2	2.4	6.4	15.6	18.3	24.9
86	-4.4	2.2	6.2	15.4	18.1	24.7
88	-4.6	2.0	6.0	15.2	17.9	24.5
90	-4.8	1.8	5.8	15.0	17.7	24.3
92	-5.0	1.6	5.6	14.8	17.5	24.1
94	-5.2	1.4	5.4	14.6	17.3	23.9
96	-5.4	1.2	5.2	14.5	17.1	23.7
98	-5.6	1.0	5.0	14.3	16.9	23.5
100	-5.8	0.8	4.8	14.1	16.7	23.3
102	-6.0	0.6	4.6	13.9	16.5	23.1
104	-6.2	0.4	4.4	13.7	16.3	22.9
106	-6.4	0.2	4.2	13.5	16.1	22.7
108	-6.6	0.1	4.0	13.3	15.9	22.5
110	-6.8	-0.1	3.8	13.1	15.7	22.3
112	-7.0	-0.3	3.6	12.9	15.5	22.1
114	-7.2	-0.5	3.4	12.7	15.3	21.9

Outdoor heat exchanger temperature of Defrost **OUT**

Outdoor temperature (°F)	Outdoor heat exchanger temperature (°F)
44.6	48.3
42.8	49.6
41.0	50.9
39.2	52.1
37.4	53.4
35.6	53.6
33.8	53.6
32.0	53.6
30.2	53.6
28.4	53.6
26.6	53.6
24.8	53.6
23.0	53.6
21.2	53.6
19.4	53.6
17.6	53.6
15.8	53.6
14.0	53.6
12.2	53.6
10.4	53.6
8.6	53.6
6.8	53.6
5.0	53.6

2MXT(H)

Outdoor heat exchanger temperature of Defrost **IN**

Compressor speed [rps]	Outdoor temperature (°F)							
	-13.0	-11.2	-3.1	14.0	19.4	32.0	35.6	44.6
6	-10.2	-8.9	-2.9	9.6	13.6	22.8	25.5	28.4
8	-10.6	-9.2	-3.3	9.3	13.2	22.5	25.1	28.4
10	-10.9	-9.6	-3.6	8.9	12.9	22.1	24.8	28.4
12	-11.3	-9.9	-4.0	8.6	12.5	21.8	24.4	28.4
14	-11.6	-10.3	-4.3	8.2	12.2	21.4	24.1	28.4
16	-12.0	-10.6	-4.7	7.9	11.8	21.1	23.7	28.4
18	-12.3	-11.0	-5.0	7.5	11.5	20.7	23.4	28.4
20	-12.7	-11.3	-5.4	7.2	11.1	20.4	23.0	28.4
22	-13.0	-11.7	-5.7	6.8	10.8	20.0	22.7	28.4
24	-13.4	-12.0	-6.1	6.5	10.4	19.7	22.3	28.4
26	-13.7	-12.4	-6.4	6.1	10.1	19.3	22.0	28.4
28	-14.1	-12.7	-6.8	5.8	9.7	19.0	21.6	28.2
30	-14.4	-13.1	-7.2	5.4	9.4	18.6	21.3	27.9
32	-14.8	-13.5	-7.5	5.1	9.0	18.3	20.9	27.5
34	-15.1	-13.8	-7.9	4.7	8.7	17.9	20.6	27.2
36	-15.5	-14.2	-8.2	4.4	8.3	17.6	20.2	26.8
38	-15.8	-14.5	-8.6	4.0	8.0	17.2	19.9	26.5
40	-16.2	-14.9	-8.9	3.7	7.6	16.9	19.5	26.1
42	-16.5	-15.2	-9.3	3.3	7.3	16.5	19.2	25.8
44	-16.9	-15.6	-9.6	2.9	6.9	16.2	18.8	25.4
46	-17.2	-15.9	-10.0	2.6	6.6	15.8	18.5	25.1
48	-17.6	-16.3	-10.3	2.2	6.2	15.5	18.1	24.7
50	-17.9	-16.6	-10.7	1.9	5.9	15.1	17.8	24.4
52	-18.3	-17.0	-11.0	1.5	5.5	14.8	17.4	24.0
54	-18.6	-17.3	-11.4	1.2	5.2	14.4	17.1	23.7
56	-19.0	-17.7	-11.7	0.8	4.8	14.1	16.7	23.3
58	-19.3	-18.0	-12.1	0.5	4.5	13.7	16.3	23.0
60	-19.7	-18.4	-12.4	0.1	4.1	13.4	16.0	22.6
62	-20.0	-18.7	-12.8	-0.2	3.7	13.0	15.6	22.3
64	-20.4	-19.1	-13.1	-0.6	3.4	12.7	15.3	21.9
66	-20.7	-19.4	-13.5	-0.9	3.0	12.3	14.9	21.6
68	-21.1	-19.8	-13.8	-1.3	2.7	11.9	14.6	21.2
70	-21.5	-20.1	-14.2	-1.6	2.3	11.6	14.2	20.8
72	-21.8	-20.5	-14.5	-2.0	2.0	11.2	13.9	20.5
74	-22.0	-20.8	-14.9	-2.3	1.6	10.9	13.5	20.1
76	-22.0	-21.2	-15.2	-2.7	1.3	10.5	13.2	19.8
78	-22.0	-21.5	-15.6	-3.0	0.9	10.2	12.8	19.4
80	-22.0	-21.9	-15.9	-3.4	0.6	9.8	12.5	19.1
82	-22.0	-22.0	-16.3	-3.7	0.2	9.5	12.1	18.7
84	-22.0	-22.0	-16.6	-4.1	-0.1	9.1	11.8	18.4
86	-22.0	-22.0	-17.0	-4.4	-0.5	8.8	11.4	18.0
88	-22.0	-22.0	-17.3	-4.8	-0.8	8.4	11.1	17.7
90	-22.0	-22.0	-17.7	-5.1	-1.2	8.1	10.7	17.3
92	-22.0	-22.0	-18.0	-5.5	-1.5	7.7	10.4	17.0
94	-22.0	-22.0	-18.4	-5.8	-1.9	7.4	10.0	16.6
96	-22.0	-22.0	-18.8	-6.2	-2.2	7.0	9.7	16.3
98	-22.0	-22.0	-19.1	-6.5	-2.6	6.7	9.3	15.9
100	-22.0	-22.0	-19.5	-6.9	-2.9	6.3	9.0	15.6
102	-22.0	-22.0	-19.8	-7.2	-3.3	6.0	8.6	15.2
104	-22.0	-22.0	-20.2	-7.6	-3.6	5.6	8.3	14.9
106	-22.0	-22.0	-20.5	-8.0	-4.0	5.3	7.9	14.5
108	-22.0	-22.0	-20.9	-8.3	-4.3	4.9	7.6	14.2
110	-22.0	-22.0	-21.2	-8.7	-4.7	4.6	7.2	13.8
112	-22.0	-22.0	-21.6	-9.0	-5.0	4.2	6.9	13.5
114	-22.0	-22.0	-21.9	-9.4	-5.4	3.9	6.5	13.1

Outdoor heat exchanger temperature of Defrost **OUT**

Outdoor temperature (°F)	Outdoor heat exchanger temperature (°F)
44.6	48.3
42.8	49.6
41.0	50.9
39.2	52.1
37.4	53.4
35.6	53.6
33.8	53.6
32.0	53.6
30.2	53.6
28.4	53.6
26.6	53.6
24.8	53.6
23.0	53.6
21.2	53.6
19.4	53.6
17.6	53.6
15.8	53.6
14.0	53.6
12.2	53.6
10.4	53.6
8.6	53.6
6.8	53.6
5.0	53.6
3.2	53.6
1.4	53.6
-0.4	53.6
-2.2	53.6
-4.0	53.6
-5.8	53.6
-7.6	53.6
-9.4	53.6
-11.2	53.6
-13.0	53.6

3/4MXM

Outdoor heat exchanger temperature of Defrost **IN**

Compressor speed [rpm]	Outdoor temperature (°F)					
	5.0	14.0	19.4	32.0	35.6	44.6
6	3.0	9.6	13.6	22.8	25.5	28.4
8	2.7	9.3	13.2	22.5	25.1	28.4
10	2.3	8.9	12.9	22.1	24.8	28.4
12	2.0	8.6	12.5	21.8	24.4	28.4
14	1.6	8.2	12.2	21.4	24.1	28.4
16	1.3	7.9	11.8	21.1	23.7	28.4
18	0.9	7.5	11.5	20.7	23.4	28.4
20	0.6	7.2	11.1	20.4	23.0	28.4
22	0.2	6.8	10.8	20.0	22.7	28.4
24	-0.1	6.5	10.4	19.7	22.3	28.4
26	-0.5	6.1	10.1	19.3	22.0	28.4
28	-0.9	5.8	9.7	19.0	21.6	28.2
30	-1.2	5.4	9.4	18.6	21.3	27.9
32	-1.6	5.1	9.0	18.3	20.9	27.5
34	-1.9	4.7	8.7	17.9	20.6	27.2
36	-2.3	4.4	8.3	17.6	20.2	26.8
38	-2.6	4.0	8.0	17.2	19.9	26.5
40	-3.0	3.7	7.6	16.9	19.5	26.1
42	-3.3	3.3	7.3	16.5	19.2	25.8
44	-3.7	2.9	6.9	16.2	18.8	25.4
46	-4.0	2.6	6.6	15.8	18.5	25.1
48	-4.4	2.2	6.2	15.5	18.1	24.7
50	-4.7	1.9	5.9	15.1	17.8	24.4
52	-5.1	1.5	5.5	14.8	17.4	24.0
54	-5.4	1.2	5.2	14.4	17.1	23.7
56	-5.8	0.8	4.8	14.1	16.7	23.3
58	-6.1	0.5	4.5	13.7	16.3	23.0
60	-6.5	0.1	4.1	13.4	16.0	22.6
62	-6.8	-0.2	3.7	13.0	15.6	22.3
64	-7.2	-0.6	3.4	12.7	15.3	21.9
66	-7.5	-0.9	3.0	12.3	14.9	21.6
68	-7.9	-1.3	2.7	11.9	14.6	21.2
70	-8.2	-1.6	2.3	11.6	14.2	20.8
72	-8.6	-2.0	2.0	11.2	13.9	20.5
74	-8.9	-2.3	1.6	10.9	13.5	20.1
76	-9.3	-2.7	1.3	10.5	13.2	19.8
78	-9.6	-3.0	0.9	10.2	12.8	19.4
80	-10.0	-3.4	0.6	9.8	12.5	19.1
82	-10.3	-3.7	0.2	9.5	12.1	18.7
84	-10.7	-4.1	-0.1	9.1	11.8	18.4
86	-11.0	-4.4	-0.5	8.8	11.4	18.0
88	-11.4	-4.8	-0.8	8.4	11.1	17.7
90	-11.7	-5.1	-1.2	8.1	10.7	17.3
92	-12.1	-5.5	-1.5	7.7	10.4	17.0
94	-12.5	-5.8	-1.9	7.4	10.0	16.6
96	-12.8	-6.2	-2.2	7.0	9.7	16.3
98	-13.2	-6.5	-2.6	6.7	9.3	15.9
100	-13.5	-6.9	-2.9	6.3	9.0	15.6
102	-13.9	-7.2	-3.3	6.0	8.6	15.2
104	-14.2	-7.6	-3.6	5.6	8.3	14.9
106	-14.6	-8.0	-4.0	5.3	7.9	14.5
108	-14.9	-8.3	-4.3	4.9	7.6	14.2
110	-15.3	-8.7	-4.7	4.6	7.2	13.8
112	-15.6	-9.0	-5.0	4.2	6.9	13.5
114	-16.0	-9.4	-5.4	3.9	6.5	13.1

Outdoor heat exchanger temperature of Defrost **OUT**

Outdoor temperature (°F)	Outdoor heat exchanger temperature (°F)
44.6	48.3
42.8	49.6
41.0	50.9
39.2	52.1
37.4	53.4
35.6	53.6
33.8	53.6
32.0	53.6
30.2	53.6
28.4	53.6
26.6	53.6
24.8	53.6
23.0	53.6
21.2	53.6
19.4	53.6
17.6	53.6
15.8	53.6
14.0	53.6
12.2	53.6
10.4	53.6
8.6	53.6
6.8	53.6
5.0	53.6

5MXM

Outdoor heat exchanger temperature of Defrost **IN**

Compressor speed [rps]	Outdoor temperature (°F)					
	5.0	14.0	19.4	32.0	35.6	44.6
6	4.6	12.4	17.0	27.9	28.4	28.4
8	4.5	12.2	16.8	27.7	28.4	28.4
10	4.3	12.0	16.7	27.5	28.4	28.4
12	4.1	11.8	16.5	27.3	28.4	28.4
14	3.9	11.7	16.3	27.1	28.4	28.4
16	3.7	11.5	16.1	26.9	28.4	28.4
18	3.6	11.3	15.9	26.8	28.4	28.4
20	3.4	11.1	15.7	26.6	28.4	28.4
22	3.2	10.9	15.6	26.4	28.4	28.4
24	3.0	10.7	15.4	26.2	28.4	28.4
26	2.8	10.6	15.2	26.0	28.4	28.4
28	2.6	10.4	15.0	25.8	28.4	28.4
30	2.5	10.2	14.8	25.7	28.4	28.4
32	2.3	10.0	14.6	25.5	28.2	28.4
34	2.1	9.8	14.5	25.3	28.0	28.4
36	1.9	9.6	14.3	25.1	27.9	28.4
38	1.7	9.5	14.1	24.9	27.7	28.4
40	1.5	9.3	13.9	24.7	27.5	28.4
42	1.4	9.1	13.7	24.6	27.3	28.4
44	1.2	8.9	13.6	24.4	27.1	28.4
46	1.0	8.7	13.4	24.2	27.0	28.4
48	0.8	8.5	13.2	24.0	26.8	28.4
50	0.6	8.4	13.0	23.8	26.6	28.4
52	0.4	8.2	12.8	23.6	26.4	28.4
54	0.3	8.0	12.6	23.5	26.2	28.4
56	0.1	7.8	12.5	23.3	26.0	28.4
58	-0.1	7.6	12.3	23.1	25.9	28.4
60	-0.3	7.4	12.1	22.9	25.7	28.4
62	-0.5	7.3	11.9	22.7	25.5	28.4
64	-0.7	7.1	11.7	22.6	25.3	28.4
66	-0.8	6.9	11.5	22.4	25.1	28.4
68	-1.0	6.7	11.4	22.2	24.9	28.4
70	-1.2	6.5	11.2	22.0	24.8	28.4
72	-1.4	6.4	11.0	21.8	24.6	28.4
74	-1.6	6.2	10.8	21.6	24.4	28.4
76	-1.8	6.0	10.6	21.5	24.2	28.4
78	-1.9	5.8	10.4	21.3	24.0	28.4
80	-2.1	5.6	10.3	21.1	23.8	28.4
82	-2.3	5.4	10.1	20.9	23.7	28.4
84	-2.5	5.3	9.9	20.7	23.5	28.4
86	-2.7	5.1	9.7	20.5	23.3	28.4
88	-2.8	4.9	9.5	20.4	23.1	28.4
90	-3.0	4.7	9.3	20.2	22.9	28.4
92	-3.2	4.5	9.2	20.0	22.7	28.4
94	-3.4	4.3	9.0	19.8	22.6	28.4
96	-3.6	4.2	8.8	19.6	22.4	28.4
98	-3.8	4.0	8.6	19.4	22.2	28.4
100	-3.9	3.8	8.4	19.3	22.0	28.4
102	-4.1	3.6	8.2	19.1	21.8	28.4
104	-4.3	3.4	8.1	18.9	21.7	28.4
106	-4.5	3.2	7.9	18.7	21.5	28.4
108	-4.7	3.1	7.7	18.5	21.3	28.2
110	-4.9	2.9	7.5	18.3	21.1	28.0
112	-5.0	2.7	7.3	18.2	20.9	27.8
114	-5.2	2.5	7.2	18.0	20.7	27.6

Outdoor heat exchanger temperature of Defrost **OUT**

Outdoor temperature (°F)	Outdoor heat exchanger temperature (°F)
44.6	48.3
42.8	49.6
41.0	50.9
39.2	52.1
37.4	53.4
35.6	53.6
33.8	53.6
32.0	53.6
30.2	53.6
28.4	53.6
26.6	53.6
24.8	53.6
23.0	53.6
21.2	53.6
19.4	53.6
17.6	53.6
15.8	53.6
14.0	53.6
12.2	53.6
10.4	53.6
8.6	53.6
6.8	53.6
5.0	53.6

3/4/5MXT(H)

Outdoor heat exchanger temperature of Defrost **IN**

Compressor speed [rpm]	Outdoor temperature (°F)							
	-13.0	-11.2	-3.1	14.0	19.4	32.0	35.6	44.6
6	-10.8	-9.3	-2.3	12.4	17.0	27.9	28.4	28.4
8	-11.0	-9.5	-2.5	12.2	16.8	27.7	28.4	28.4
10	-11.2	-9.6	-2.7	12.0	16.7	27.5	28.4	28.4
12	-11.4	-9.8	-2.9	11.8	16.5	27.3	28.4	28.4
14	-11.6	-10.0	-3.0	11.7	16.3	27.1	28.4	28.4
16	-11.7	-10.2	-3.2	11.5	16.1	26.9	28.4	28.4
18	-11.9	-10.4	-3.4	11.3	15.9	26.8	28.4	28.4
20	-12.1	-10.6	-3.6	11.1	15.7	26.6	28.4	28.4
22	-12.3	-10.7	-3.8	10.9	15.6	26.4	28.4	28.4
24	-12.5	-10.9	-4.0	10.7	15.4	26.2	28.4	28.4
26	-12.6	-11.1	-4.1	10.6	15.2	26.0	28.4	28.4
28	-12.8	-11.3	-4.3	10.4	15.0	25.8	28.4	28.4
30	-13.0	-11.5	-4.5	10.2	14.8	25.7	28.4	28.4
32	-13.2	-11.7	-4.7	10.0	14.6	25.5	28.2	28.4
34	-13.4	-11.8	-4.9	9.8	14.5	25.3	28.0	28.4
36	-13.6	-12.0	-5.1	9.6	14.3	25.1	27.9	28.4
38	-13.7	-12.2	-5.2	9.5	14.1	24.9	27.7	28.4
40	-13.9	-12.4	-5.4	9.3	13.9	24.7	27.5	28.4
42	-14.1	-12.6	-5.6	9.1	13.7	24.6	27.3	28.4
44	-14.3	-12.7	-5.8	8.9	13.6	24.4	27.1	28.4
46	-14.5	-12.9	-6.0	8.7	13.4	24.2	27.0	28.4
48	-14.7	-13.1	-6.2	8.5	13.2	24.0	26.8	28.4
50	-14.8	-13.3	-6.3	8.4	13.0	23.8	26.6	28.4
52	-15.0	-13.5	-6.5	8.2	12.8	23.6	26.4	28.4
54	-15.2	-13.7	-6.7	8.0	12.6	23.5	26.2	28.4
56	-15.4	-13.8	-6.9	7.8	12.5	23.3	26.0	28.4
58	-15.6	-14.0	-7.1	7.6	12.3	23.1	25.9	28.4
60	-15.8	-14.2	-7.2	7.4	12.1	22.9	25.7	28.4
62	-15.9	-14.4	-7.4	7.3	11.9	22.7	25.5	28.4
64	-16.1	-14.6	-7.6	7.1	11.7	22.6	25.3	28.4
66	-16.3	-14.8	-7.8	6.9	11.5	22.4	25.1	28.4
68	-16.5	-14.9	-8.0	6.7	11.4	22.2	24.9	28.4
70	-16.7	-15.1	-8.2	6.5	11.2	22.0	24.8	28.4
72	-16.9	-15.3	-8.3	6.4	11.0	21.8	24.6	28.4
74	-17.0	-15.5	-8.5	6.2	10.8	21.6	24.4	28.4
76	-17.2	-15.7	-8.7	6.0	10.6	21.5	24.2	28.4
78	-17.4	-15.9	-8.9	5.8	10.4	21.3	24.0	28.4
80	-17.6	-16.0	-9.1	5.6	10.3	21.1	23.8	28.4
82	-17.8	-16.2	-9.3	5.4	10.1	20.9	23.7	28.4
84	-18.0	-16.4	-9.4	5.3	9.9	20.7	23.5	28.4
86	-18.1	-16.6	-9.6	5.1	9.7	20.5	23.3	28.4
88	-18.3	-16.8	-9.8	4.9	9.5	20.4	23.1	28.4
90	-18.5	-17.0	-10.0	4.7	9.3	20.2	22.9	28.4
92	-18.7	-17.1	-10.2	4.5	9.2	20.0	22.7	28.4
94	-18.9	-17.3	-10.4	4.3	9.0	19.8	22.6	28.4
96	-19.0	-17.5	-10.5	4.2	8.8	19.6	22.4	28.4
98	-19.2	-17.7	-10.7	4.0	8.6	19.4	22.2	28.4
100	-19.4	-17.9	-10.9	3.8	8.4	19.3	22.0	28.4
102	-19.6	-18.0	-11.1	3.6	8.2	19.1	21.8	28.4
104	-19.8	-18.2	-11.3	3.4	8.1	18.9	21.7	28.4
106	-20.0	-18.4	-11.5	3.2	7.9	18.7	21.5	28.4
108	-20.1	-18.6	-11.6	3.1	7.7	18.5	21.3	28.2
110	-20.3	-18.8	-11.8	2.9	7.5	18.3	21.1	28.0
112	-20.5	-19.0	-12.0	2.7	7.3	18.2	20.9	27.8
114	-20.7	-19.1	-12.2	2.5	7.2	18.0	20.7	27.6

Outdoor heat exchanger temperature of Defrost **OUT**

Outdoor temperature (°F)	Outdoor heat exchanger temperature (°F)
44.6	48.3
42.8	49.6
41.0	50.9
39.2	52.1
37.4	53.4
35.6	53.6
33.8	53.6
32.0	53.6
30.2	53.6
28.4	53.6
26.6	53.6
24.8	53.6
23.0	53.6
21.2	53.6
19.4	53.6
17.6	53.6
15.8	53.6
14.0	53.6
12.2	53.6
10.4	53.6
8.6	53.6
6.8	53.6
5.0	53.6
3.2	53.6
1.4	53.6
-0.4	53.6
-2.2	53.6
-4.0	53.6
-5.8	53.6
-7.6	53.6
-9.4	53.6
-11.2	53.6
-13.0	53.6

6.13 Low Compressor Speed High Pressure Limit

Outline

The system controls the upper limit of the compressor speed to prevent abnormal high pressure while the compressor speed is low. Control is carried out according to three zones.

Details

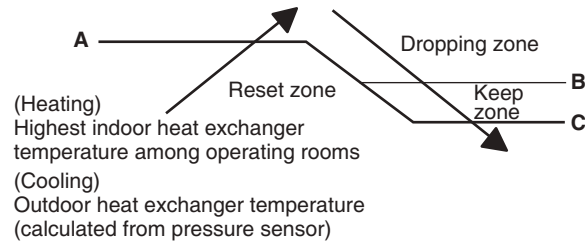

R4004267

Cooling

$A (^{\circ}\text{C}) = D \times \text{target compressor speed} + E \times \text{Lowest indoor heat exchanger temperature among operating rooms} + F$

Heating

$A (^{\circ}\text{C}) = G \times \text{target compressor speed} + H \times \text{outdoor heat exchanger} + J$

$A \leq 56^{\circ}\text{C}$ (When the above is 56°C or higher)

B ($^{\circ}\text{C}$): $A - 1 (^{\circ}\text{C})$

C ($^{\circ}\text{C}$): $A - 4 (^{\circ}\text{C})$

■ 2MXM

	Target Compressor speed < 8	$16 \leq$ Target Compressor speed < 14	$21 \leq$ Target Compressor speed < 30
D	224/256	546/256	96/256
E	0/256	0/256	0/256
F	34.5	24.5	49
G	224/256	546/256	96/256
H	0/256	0/256	0/256
J	34.5	24.5	49

■ 3/4MXM, 2MXT(H)

	Target Compressor speed < 15	$16 \leq$ Target Compressor speed < 20	$21 \leq$ Target Compressor speed < 25
D	0/256	312/256	512/256
E	0/256	0/256	0/256
F	43.5	25.5	10
G	0/256	312/256	512/256
H	0/256	0/256	0/256
J	43.5	25.5	10

■ 5MXM, 3/4/5MXT(H)

	Target Compressor speed < 16	$16 \leq$ Target Compressor speed < 21	$21 \leq$ Target Compressor speed < 25
D	90/256	130/256	220/256
E	90/256	90/256	60/256
F	32.5	30.5	27.5
G	90/256	130/256	220/256
H	90/256	90/256	60/256
J	32.5	30.5	27.5

6.14 Electronic Expansion Valve Control

Outline

The following items are included in the electronic expansion valve control.

Electronic expansion valve is fully closed

1. Electronic expansion valve is fully closed when turning on the power.
2. Pressure equalizing control

Room Distribution Control

1. Gas pipe isothermal control
2. SC (subcooling) control
3. Liquid pipe temperature control (with all ports connected and all rooms being air-conditioned)
4. Liquid pipe temperature control for rooms not in operation
5. Dew prevention control for indoor rotor

Open Control

1. Electronic expansion valve control when starting operation
2. Electronic expansion valve control when the compressor speed changes
3. Electronic expansion valve control for defrosting
4. Electronic expansion valve control for oil recovery
5. Electronic expansion valve control when a discharge pipe temperature is abnormally high
6. Electronic expansion valve control when the discharge pipe thermistor is disconnected
7. Electronic expansion valve control for indoor unit anti-icing control

Feedback Control

Target discharge pipe temperature control

Details

The following are the examples of the electronic expansion valve control for each operation mode.

Operation pattern		● : Available — : Not available	Gas pipe isothermal control	SC (subcooling) control	Control when the compressor speed changes	Control for abnormally high discharge pipe temperature	Oil recovery control	Indoor anti-icing control	Liquid pipe temperature control	Liquid pipe temperature control for non-operating units	Dew prevention control for indoor rotor
When power is turned on	Fully closed when power is turned on		—	—	—	—	—	—	—	—	—
Cooling, 1 room operation	Open control when starting		—	—	●	●	●	—	—	—	—
	(Control of target discharge pipe temperature)		—	—	●	●	●	—	—	●	—
Cooling, 2 rooms operation to Cooling, 4 rooms operation	Control when the operating room is changed		—	—	●	●	●	—	—	●	—
	(Control of target discharge pipe temperature)		●	—	●	●	●	—	—	●	—
Stop	Pressure equalizing control		—	—	—	—	—	—	—	—	—
Heating, 1 room operation	Open control when starting		—	—	●	—	—	—	—	—	—
	(Control of target discharge pipe temperature)		—	● ★2	●	●	—	—	● ★1	● ★3	—
Heating, 2 rooms operation	Control when the operating room is changed		—	—	●	—	—	—	—	—	—
	(Control of target discharge pipe temperature)		—	● ★2	●	●	—	—	● ★1	● ★3	—
	(Defrost control)		—	—	—	—	—	—	—	—	—
Stop	Pressure equalizing control		—	—	—	—	—	—	—	—	—
Heating operation	Open control when starting		—	—	●	—	—	—	—	—	—
	Discharge pipe thermistor disconnection control	Continue	—	● ★2	—	—	—	—	● ★1	● ★3	—
Stop	Pressure equalizing control		—	—	—	—	—	—	—	—	—

R4004269

★1: When all the indoor units are operating, liquid pipe temperature control is conducted.

★2: SC (subcooling) control is conducted for the operating indoor units, when some of the units are not operating.

★3: Liquid pipe temperature control for stopped room is conducted for the non-operating indoor units.

6.14.1 Initialization as Power Supply On

The electronic expansion valve is initialized (fully closed) when the power is turned on. Then, the valve opening position is set and the pressure is equalized.

6.14.2 Pressure Equalizing Control

When the compressor is stopped, the pressure equalizing control is activated. The electronic expansion valve opens, and develops the pressure equalization.

6.14.3 Opening Limit Control

The maximum and minimum opening of the electronic expansion valve are limited.

	2/3/4MXM 2MXT(H)	5MXM 3/4/5MXT(H)
Max. valve opening (pulse)	480	480
Min. valve opening (pulse)	42	44

* In the room the unit is in operation

The electronic expansion valve is fully closed in the room where cooling is stopped and is opened at a fixed degree during defrosting.

6.14.4 Starting Operation Control/Changing Operation Room

The electronic expansion valve opening is controlled when the operation starts, thus preventing superheating or liquid compression.

6.14.5 Control when the Compressor Speed Changes

When the target discharge pipe temperature control is active, if the target compressor speed changes to a specified value in a certain period of time, the target discharge pipe temperature control is canceled and the target opening of the electronic expansion valve is changed.

6.14.6 Oil Recovery Function

Outline

The electronic expansion valve opening for the room not in operation is set as to open for a certain time at a specified interval so that the oil for the room not in operation may not be accumulated.

Details

During cooling operation, the electronic expansion valve for the room not in operation is opened every 1 hour by 80 pulses for specified time.

6.14.7 High Discharge Pipe Temperature Control

When the compressor is operating, if the discharge pipe temperature exceeds a certain value, the electronic expansion valve opens and the refrigerant runs to the low pressure side. This procedure lowers the discharge pipe temperature.

6.14.8 Discharge Pipe Thermistor Disconnection Control

Outline

The disconnection of the discharge pipe thermistor is detected by comparing the discharge pipe temperature with the condensing temperature. If the discharge pipe thermistor is disconnected, the electronic expansion valve opens according to the outdoor temperature and the operation compressor speed, operates for a specified time, and then stops.

After 3 minutes, the operation restarts and checks if the discharge pipe thermistor is disconnected. If the discharge pipe thermistor is disconnected, the system stops after operating for a specified time.

If the disconnection is detected repeatedly, the system is shut down. When the compressor runs for 60 minutes without any error, the error counter is reset.

Details

Determining thermistor disconnection

When the starting control (**A** seconds) finishes, the following adjustment is made.

1. When the operation mode is cooling

When the following condition is fulfilled, the discharge pipe thermistor disconnection is ascertained.

Discharge pipe temperature + 6°C (10.8°F) < outdoor heat exchanger temperature

2. When the operation mode is heating

When the following condition is fulfilled, the discharge pipe thermistor disconnection is ascertained.

Discharge pipe temperature + 6°C (10.8°F) < highest indoor heat exchanger temperature

	2MXM	3/4MXM 2MXT(H)	5MXM 3/4/5MXT(H)
A (seconds)	630	930	1,150

When the thermistor is disconnected

When the disconnection is ascertained, the compressor continues operation for 9 minutes and then stops.

6.14.9 Gas Pipe Isothermal Control During Cooling

When the units are operating in multiple rooms, the gas pipe temperature is detected and the electronic expansion valve opening is adjusted so that the temperature of the gas pipe in each room becomes equal.

- When the gas pipe temperature > the average gas pipe temperature,
→ the opening degree of electronic expansion valve for the corresponding room increases.
- When the gas pipe temperature < the average gas pipe temperature,
→ the opening degree of electronic expansion valve for the corresponding room decreases.

The temperatures are monitored every **A** seconds.

	2/3/4MXM 2MXT(H)	5MXM 3/4/5MXT(H)
A (seconds)	40	30

6.14.10 SC (Subcooling) Control

When the units are operating in multiple rooms, the gas pipe temperature is detected and the electronic expansion valve opening is adjusted so that the temperature of the gas pipe in each room becomes equal.

- When the gas pipe temperature > the average gas pipe temperature,
 - the opening degree of electronic expansion valve for the corresponding room increases.
 - When the gas pipe temperature < the average gas pipe temperature,
 - the opening degree of electronic expansion valve for the corresponding room decreases.
- The temperatures are monitored every **A** seconds.

	2MXM	3/4MXM	5MXM	2MXT(H)	3/4/5MXT(H)
A (seconds)	20	60	45	60	45

6.14.11 Target Discharge Pipe Temperature Control

The target discharge pipe temperature is obtained from the indoor and outdoor heat exchanger temperature, and the electronic expansion valve opening is adjusted so that the actual discharge pipe temperature becomes close to the target discharge pipe temperature. (Indirect SH (superheating) control using the discharge pipe temperature)

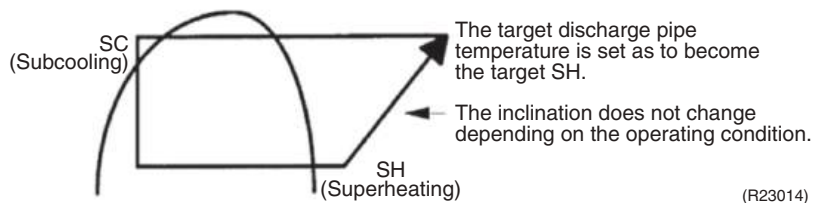

The electronic expansion valve opening and the target discharge pipe temperature are adjusted every **A** seconds. The target discharge pipe temperature is controlled by indoor heat exchanger temperature and outdoor heat exchanger temperature. The opening degree of the electronic expansion valve is adjusted by the following.

- Target discharge pipe temperature
- Actual discharge pipe temperature
- Previous discharge pipe temperature

	2/3/4MXM 2MXT(H)	5MXM 3/4/5MXT(H)
A (seconds)	20	15

6.15 Malfunctions

6.15.1 Sensor Malfunction Detection

Relating to Thermistor Malfunction

1. Outdoor heat exchanger thermistor
2. Discharge pipe thermistor
3. Radiation fin thermistor
4. Gas pipe thermistor
5. Outdoor temperature thermistor
6. Liquid pipe thermistor

6.15.2 Detection of Overcurrent and Overload

Outline

In order to protect the inverter, an excessive output current is detected and the OL temperature is observed to protect the compressor.

Details

- If the inverter current exceeds **A** A, the system shuts down the compressor.
- If the OL (Compressor head) temperature exceeds **B**°C (°F), the compressor stops.

		2MXM	3/4MXM	5MXM	2MXT(H)	3MXT(H)	4/5MXT(H)
A (A)	Cooling	13.0	19.0	27.5	19.0	27.0	27.5
	Heating	15.0	19.0	29.0	19.0	27.0	29.0
B	(°C)	125	125	125	125	125	125
	(°F)	257	257	257	257	257	257

6.15.3 Anti-icing Function

During cooling, if the indoor heat exchanger temperature in the room not in operation becomes below the specified temperature for the specified time, the electronic expansion valve is opened in the operation stopped room as specified, and the fully closed operation is carried out. After this, if freezing abnormality occurs longer than specified time, the system shuts down as the system abnormality.

Part 5

Remote Controller

1. Applicable Remote Controller and Thermostat	136
2. BRC1NRV71	137
3. ARC466A89	143
4. ARC480A83	145
5. BRC073A6	147
6. BRC944B2	151
7. Daikin One Thermostat	152

1. Applicable Remote Controller and Thermostat

Type	Model Name	Wireless R/C	Reference Page	Wired R/C and/or Thermostat	Reference Page
Wall mounted	CTXV07AVJU9	ARC480A83	145	BRC073A6 BRC944B2	147 151
	FTXV09AVJU9				
	FTXV12AVJU9				
	FTXV15AVJU9				
	FTXV18AVJU9				
	FTXV24AVJU9				
Duct concealed	CDMA07AVJU9	—	—	BRC1NRV71	137
	FDMA09AVJU9				
	FDMA12AVJU9				
	FDMA15AVJU9				
	FDMA18AVJU9				
	FDMA24AVJU9				
Floor standing	FVXV09AVJUW(T)9	ARC466A89	143	BRC073A6 (option)	147
	FVXV12AVJUW(T)9				
	FVXV15AVJUW(T)9				
	FVXV18AVJUW(T)9				
Air handling	CMXV12AVJUA	—	—	Daikin One Thermostat	152
	CMXV18AVJUA				
	CMXV24AVJUA				



Note

Refer to the operation manual of applicable model for details. You can download operation manuals from Daikin Business Portal:

Daikin Business Portal → Document Search → Item Category → Installation/Operation Manual
(URL: https://global1d.daikin.com/business_portal/login/)

2. BRC1NRV71

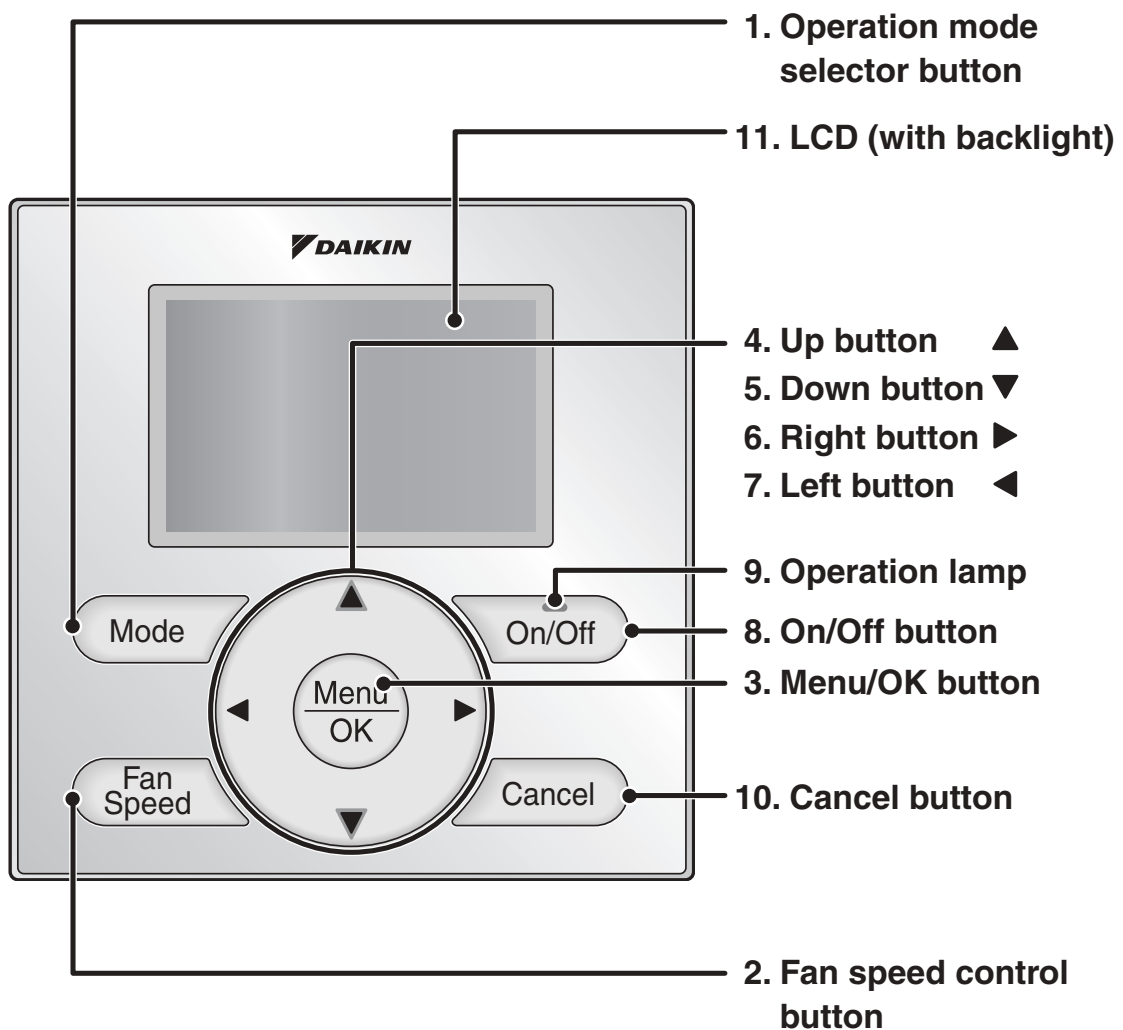

Functions other than basic operation items (i.e., On/Off, Operation Mode, Fan Speed, and Setpoint) are set from the menu screen.

NOTE

- Do not install the remote controller in places exposed to direct sunlight, the LCD will be damaged.
- Do not pull or twist the remote controller cord, the remote controller may be damaged.
- Do not use objects with sharp ends to press the buttons on the remote controller, damage may result.

R5000499

1. Operation mode selector button

- Press this button to select the operation mode of your preference. **(See page 10.)**
* Available modes vary with the model of unit.

2. Fan speed control button

- Press this button to select the fan speed of your preference. **(See page 11.)**
* Available fan speeds vary with the model of unit.

3. Menu/OK button

- Used to enter the main menu.
(See page 20 for the menu items.)
- Used to enter the selected item.

4. Up button ▲

- Used to raise the setpoint.
- The item above the current selection will be highlighted.
(The highlighted items will be scrolled continuously when the button is continuously pressed.)
- Used to change the selected item.

5. Down button ▼

- Used to lower the setpoint.
- The item below the current selection will be highlighted.
(The highlighted items will be scrolled continuously when the button is continuously pressed.)
- Used to change the selected item.

6. Right button ►

- Used to highlight the next items on the right-hand side.
- Each screen is scrolled in the right-hand direction.

7. Left button ◀

- Used to highlight the next items on the left-hand side.
- Each screen is scrolled in the left-hand direction.

8. On/Off button

- Press this button and system will start.
- Press this button again to stop the system.

9. Operation lamp

- This lamp illuminates solid green during normal operation.
- This lamp flashes if an error occurs.

10. Cancel button

- Used to return to the previous screen.

11. LCD (with backlight)

- The backlight will be illuminated for approximately 30 seconds by pressing any button.
- If two remote controllers are used to control a single unit, only the controller accessed first will have backlight functionality.

Liquid Crystal Display

- Three types of display mode (Standard, Detailed and Simple) are available.
- Standard display is set by default.
- Detailed and Simple displays can be selected in the main menu. (See page 44.)

Standard display

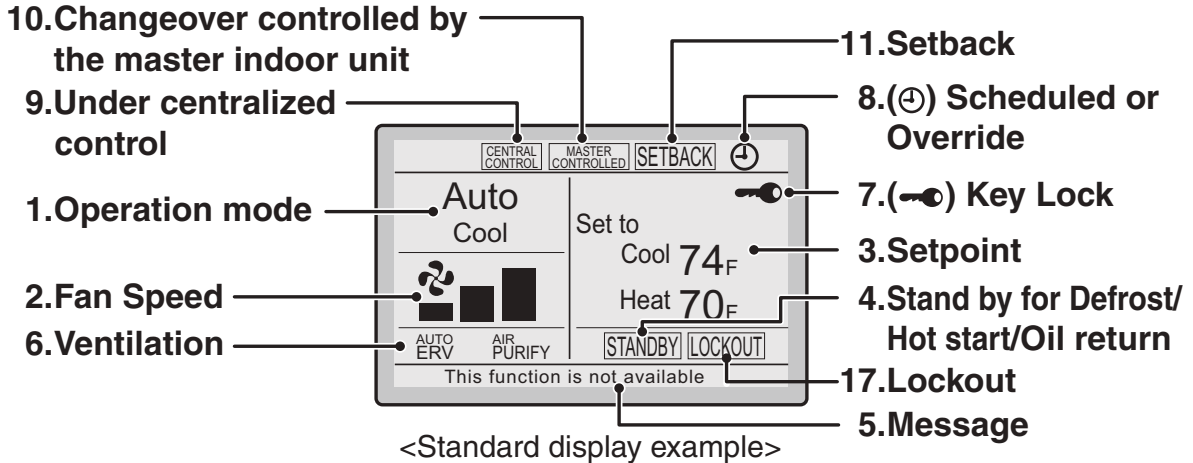

Detailed display

- The airflow direction, clock, and selectable item appear on Detailed display screen in addition to the items appearing on Standard display.

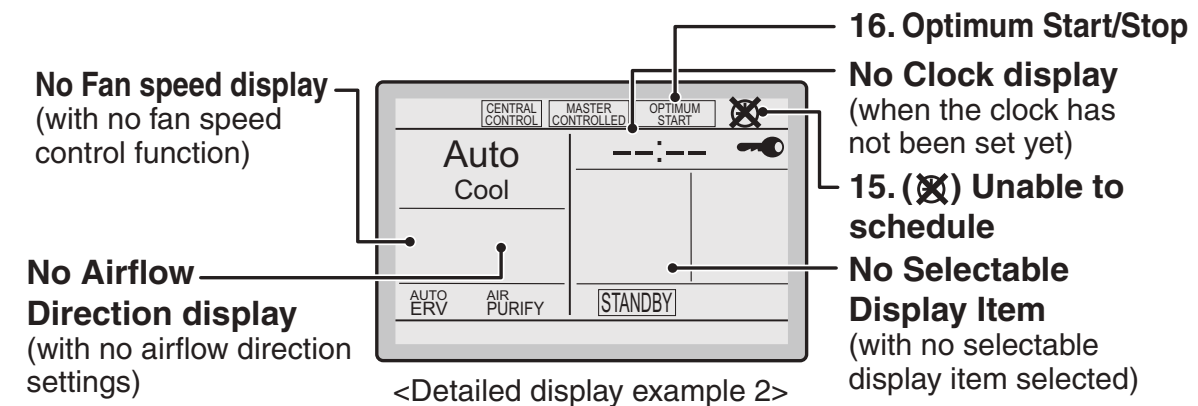
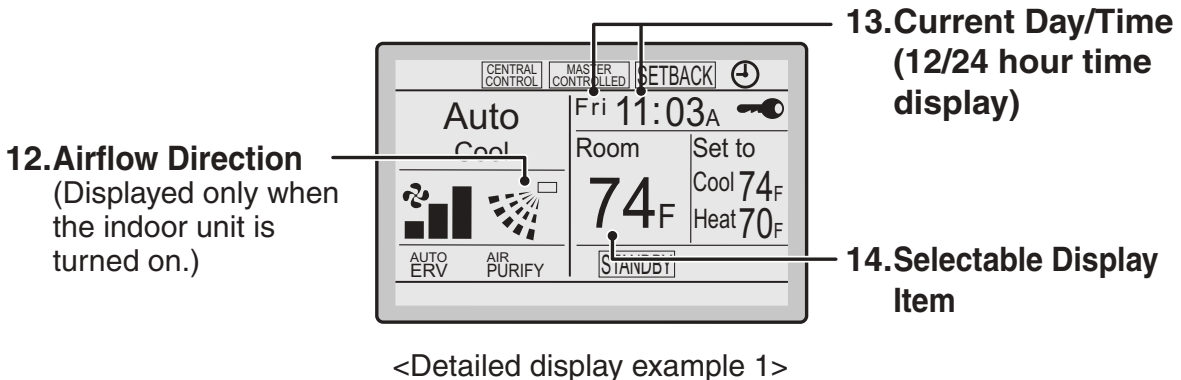

Simple display

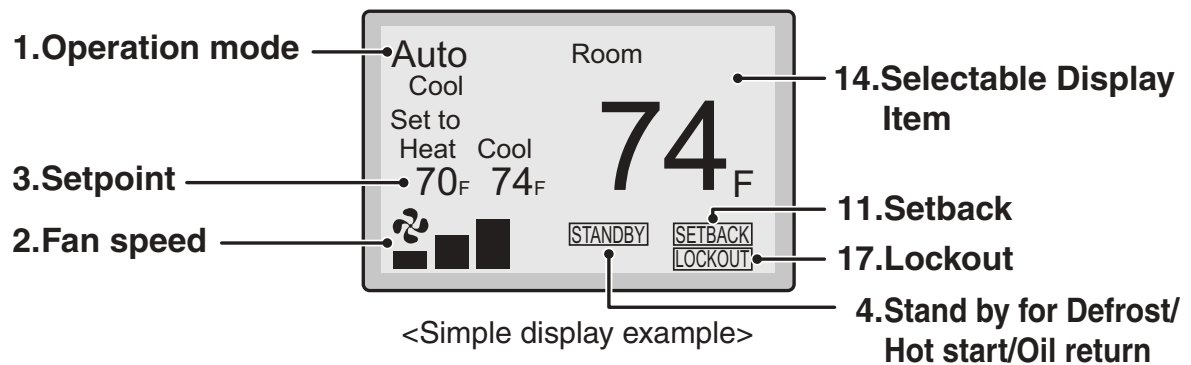

Note for all display modes

- Depending on the field settings, while the unit is stopped, OFF may be displayed instead of the operation mode and/or the setpoint may not be displayed.

1. Operation mode

- Used to display the current operation mode: Cool, Heat, Vent, Fan, Dry or Auto.
- In Auto mode, the actual operation mode (Cool or Heat) will be also displayed.
- Operation mode cannot be changed when OFF is displayed.
Operation mode can be changed after starting operation.

2. Fan Speed

- Used to display the fan speed that is set for the unit.
- The fan speed will not be displayed if the connected model does not have fan speed control functionality.

3. Setpoint

- Used to display the setpoint for the unit.
- Use the Celsius/Fahrenheit item in the main menu to select the temperature unit (Celsius or Fahrenheit).

4. Stand by for Defrost/Hot start/ Oil return “” (See page 12.)

If ventilation icon is displayed in this field:

- Indicates that an energy recovery ventilator (ERV) is connected.
For details, refer to the Operation Manual of the ERV.

5. Message

The following messages may be displayed.

“This function is not available”

- Displayed for a few seconds when an Operation button is pressed and the unit does not provide the corresponding function.
- In a remote control group, the message will not appear if at least one of the units provides the corresponding function.

“Error: Push Menu button”

“Warning: Push Menu button”

- Displayed if an error or warning is detected (see page 54).



“Time to clean filter”

“Time to clean element”

“Time to clean filter & element”

- Displayed as a reminder when it is time to clean the filter and/or element (see page 52).

6. Ventilation

- Displayed when an energy recovery ventilator is connected.
- **Ventilation Mode icon.** “ AUTO ERV BYPASS ”
These icons indicate the current ventilation mode (ERV only) (AUTO, ERV, BYPASS).
- **Air Purify ICON** “ AIR PURIFY ”
This icon indicates that the air purifying unit (Optional) is in operation.

7. Key Lock (See page 19.)

- Displayed when the key lock is set.

8. Scheduled or Override (See page 33, 38.)

- Displayed if the Schedule or Override is enabled.
- For Schedule, see page 33, for override, see page 38.
- When the Override is active, the icon will flash. “”

9. Under Centralized control “”

- Displayed if the system is under the management of a multi-zone controller (Optional) and the operation of the system through the remote controller is limited.

10. Changeover controlled by the master indoor unit “” (VRV only)

- Displayed when another indoor unit on the system has the authority to change the operation mode between cool and heat.

R5000503

11. Setback “ ” (See page 14.)

- The setback icon flashes when the unit is turned on by the setback control.

12. Airflow Direction “ ”

- Displayed when the airflow direction and swing are set (see page 26).
- If the connected model does not include oscillating louvers this item will not be displayed.

13. Current Day/Time (12/24 hour time display)

- Displayed if the clock is set (see page 46).
- If the clock is not set, “ -- : -- ” will be displayed.
- 12 hour time format is displayed by default.
- Select 12/24 hour time display option in the main menu under “Clock & Calendar”.

14. Selectable Display Item



- Room temperature is selected by default.
- For other choices see page 45.

15. ~~ⓧ~~ Unable to schedule

- Displayed when the clock needs to be set.
- The schedule function will not work unless the clock is set.

16. Optimum Start/Stop

“  ” “  ” (See page 40.)

- Displayed when the Optimum start or Optimum stop is enabled.
- “  ” or “  ” is flashing when the Optimum start or Optimum stop is active.

17. Lockout “ ”

(Rooftop unit only)

- “  ” is flashing when the lockout is active.

3. ARC466A89

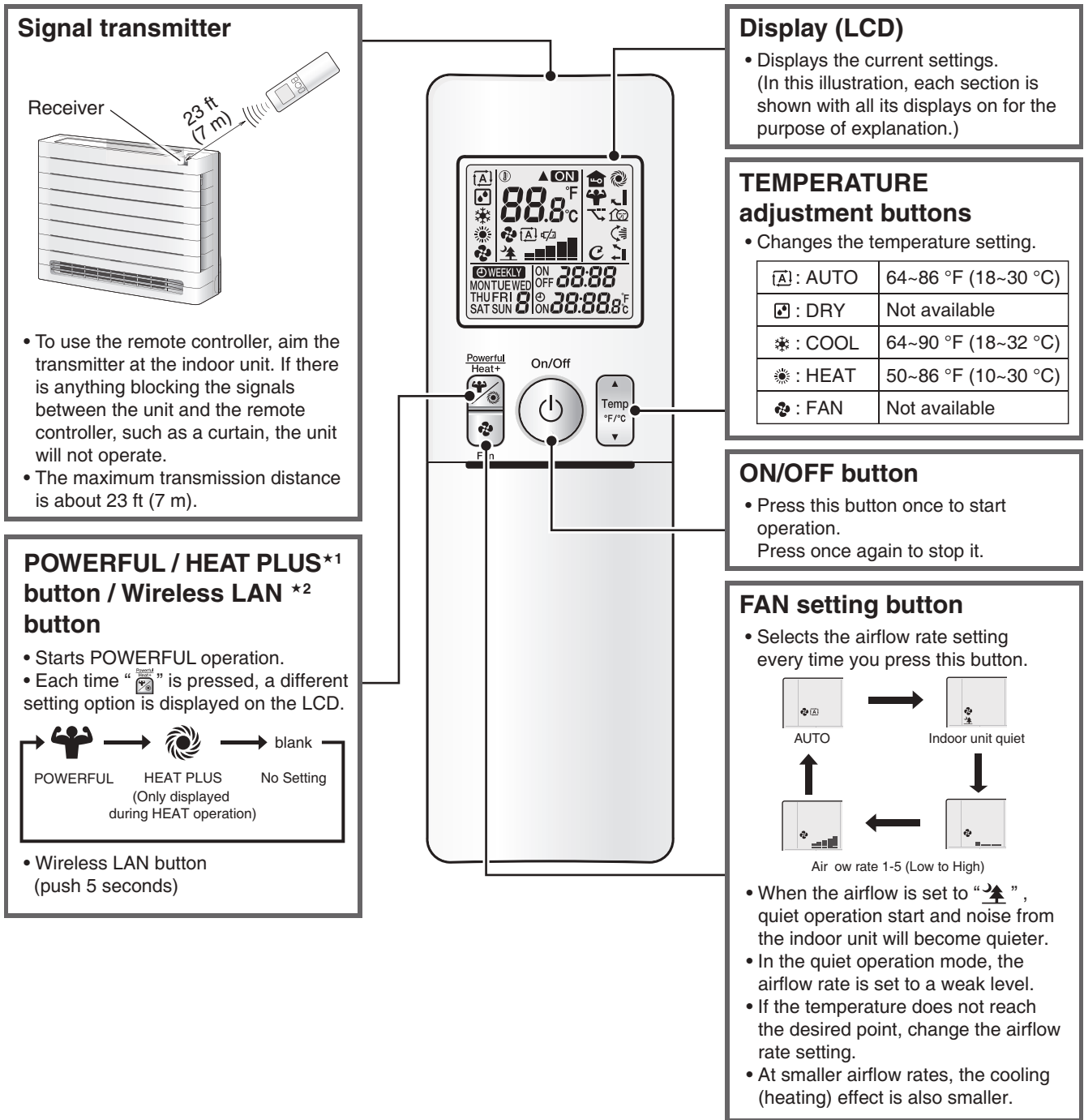

R5000555

Reference Refer to the following pages for details.

★1 POWERFUL/HEAT PLUS operation P. 85, 86

★2 Wireless LAN operation P. 98

Open the Front Cover

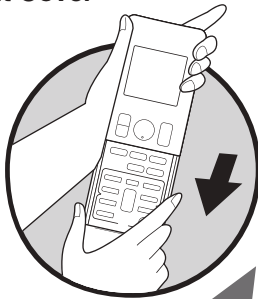

MODE button

- Selects the operation mode.

HOME LEAVE*8 button

- HOME LEAVE operation.

WEEKLY TIMER*4 buttons

Weekly

- : WEEKLY button
- : PROGRAM button
- : COPY button
- : BACK button
- : NEXT button

OFF TIMER button (NIGHT SET mode)

- Press this button and adjust the day and time with **SELECT** button.
- Press this button again to complete TIMER setting.

TIMER CANCEL button

- Cancels the timer setting.
- Cannot be used for the WEEKLY TIMER operation.

SELECT button

- Changes the clock ON/OFF TIMER and WEEKLY TIMER settings.

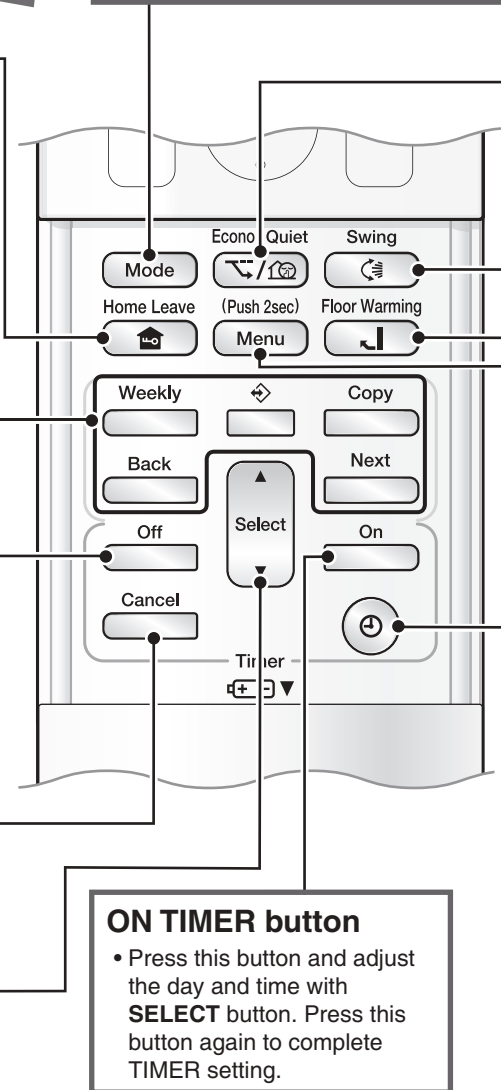

ON TIMER button

- Press this button and adjust the day and time with **SELECT** button. Press this button again to complete TIMER setting.

ECONO*3 / QUIET button

- Start ECONO/QUIET operation.
- Each time " " is pressed, a different setting option appears on the LCD.

SWING*5 button

- Adjusts the airflow direction.
- When you press **SWING** button, the flap moves up and down. The flap stops when you press **SWING** button again.

FLOOR WARMING*7 button

- Starts Floor warming operation.

MENU button (push 2 seconds)

- Adjusts the display brightness.
- Setting the air outlet selection.
- Setting airflow when indoor unit reaches setpoint.
- CLEAN operation.

CLOCK*6 button

R5000556

Reference Refer to the following pages for details.

★3 ECONO operation	P. 83	★6 Clock setting	P. 88
★4 WEEKLY TIMER operation	P. 89	★7 FLOOR WARMING Operation	P. 78
★5 Auto-swing	P. 76	★8 HOME LEAVE Operation	P. 84

4. ARC480A83

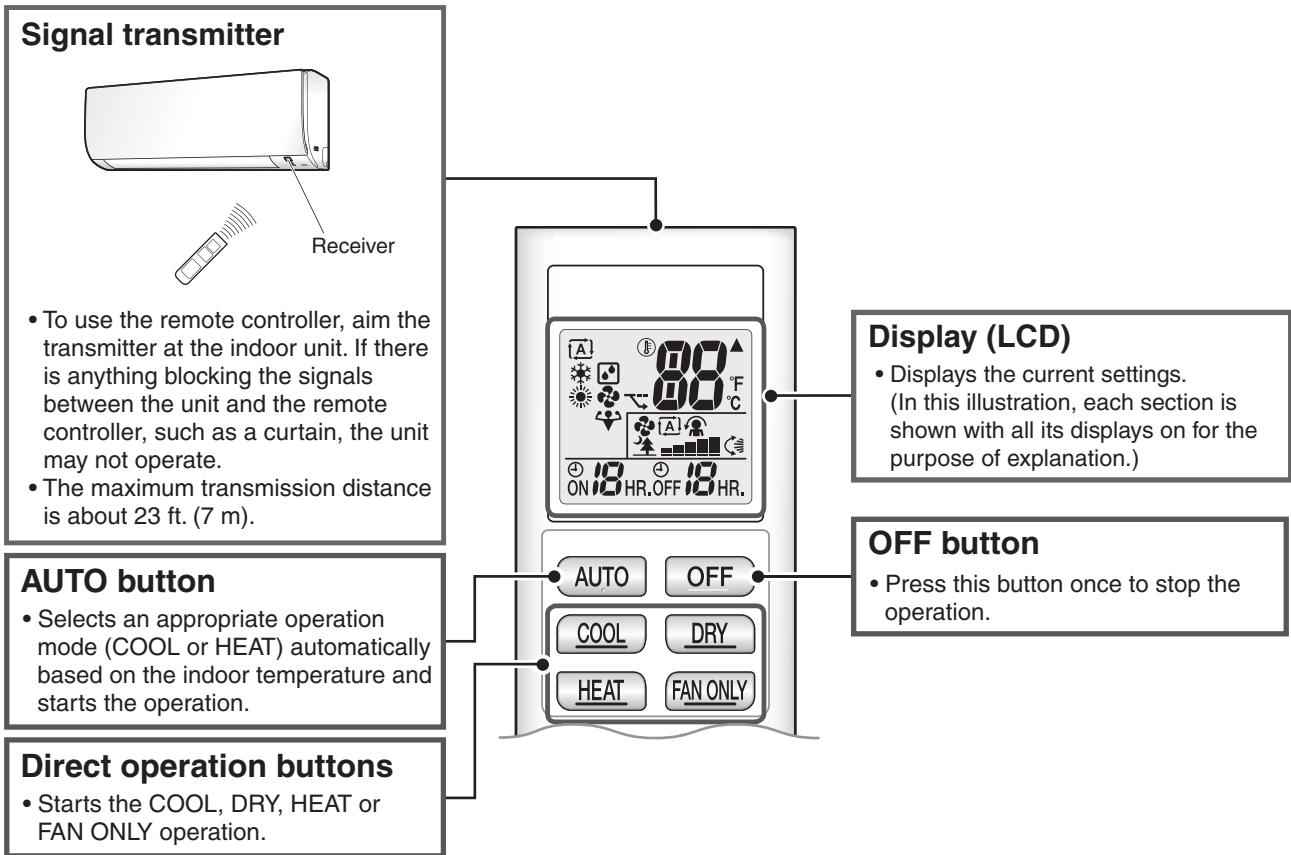

R5000453

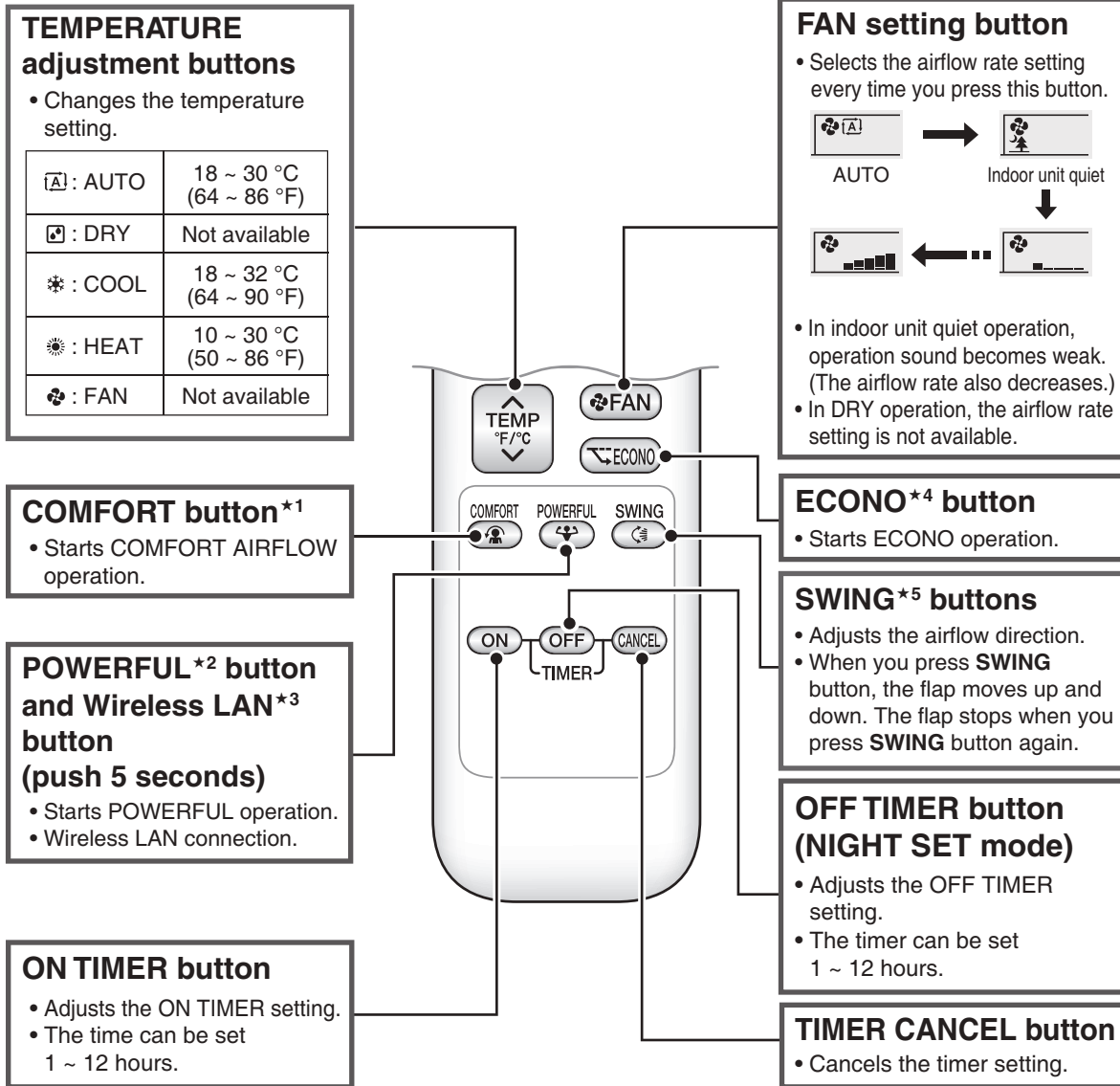

R5000461



Reference

Refer to the following pages for details.

- ★1 COMFORT AIRFLOW operation P.51
- ★2 POWERFUL operation P.57
- ★3 Wireless LAN connection P.59
- ★4 ECONO operation P.56
- ★5 Auto-swing P.50

5. BRC073A6

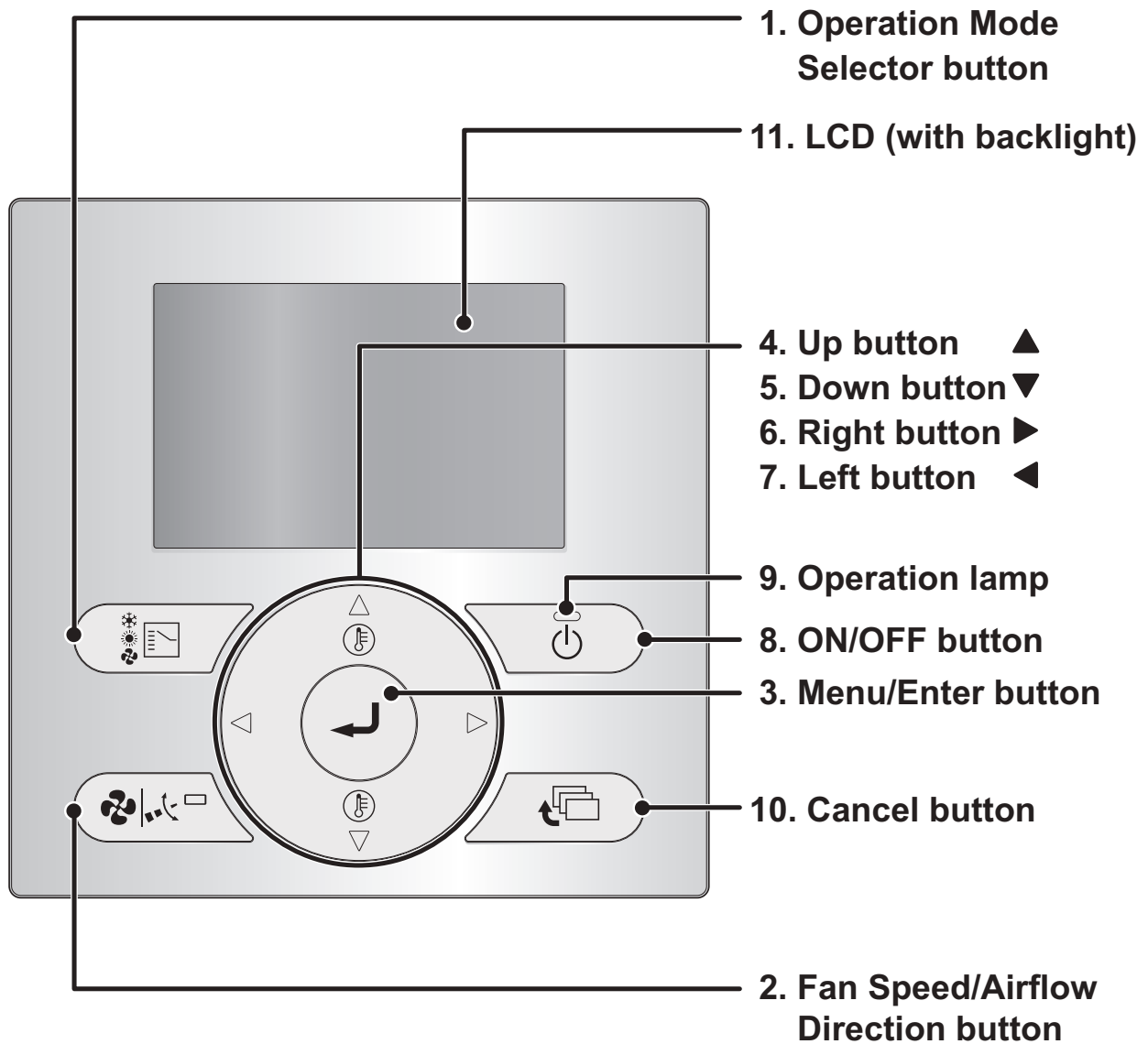

1. Operation Mode Selector button

- Press this button to select the operation mode of your preference.
- Available modes may vary with the connected model.

2. Fan Speed/Airflow Direction button

- Used to change the fan speed and airflow direction.
- Available fan speeds and airflow directions may vary with the connected model.

3. Menu/Enter button

- This button is enabled by default.
- Used to display the Main Menu or enter the selected item.

4. Up button ▲

- Used to raise the set temperature.
- The next item on the upper side will be highlighted.
(Keep pressing the button to cycle through the values or items).
- Used to change the selected item.

5. Down button ▼

- Used to lower the set temperature.
- The next item on the lower side will be highlighted.
(Keep pressing the button to cycle through the values or items).
- Used to change the selected item.

6. Right button ►

- Used to highlight the next items on the right-hand side.
- The display contents are changed to the next screen.

7. Left button ◀

- Used to highlight the next items on the left-hand side.
- The display contents are changed to the previous screen.

8. ON/OFF button

- Press to start or stop the air conditioner.

9. Operation lamp (Green)

- This lamp lights up during operation.
- This lamp is not lit when the unit operation is OFF.
- This lamp blink if an error or mode conflict occurs.

10. Cancel button

- This button is enabled by default.
- Used to return to the previous screen.

11. LCD (with backlight)

- The backlight will be lit for approximately 30 seconds when one of the buttons is pressed.
- The actions linked to the buttons, except for the ON/OFF button, are not carried out when the backlight is not lit.

Liquid Crystal Display

- There are four display methods for the liquid crystal display (LCD) available. The Standard display, which is used by default, and the Detailed display. There is also the possibility to use only Icon or Icon and Text mode (see the Installation manual).
- To change the active display method, select the desired display method in the Display Method screen.
- The displayed contents on the screen may vary with the operation mode of the connected models. (E.g.: The following display will appear when the air conditioner is in heating operation).

Standard display

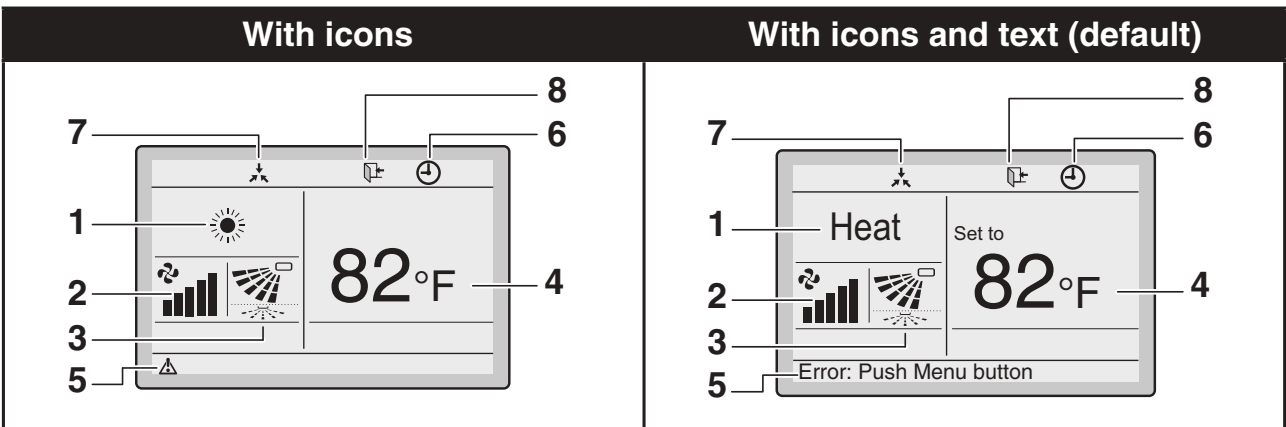





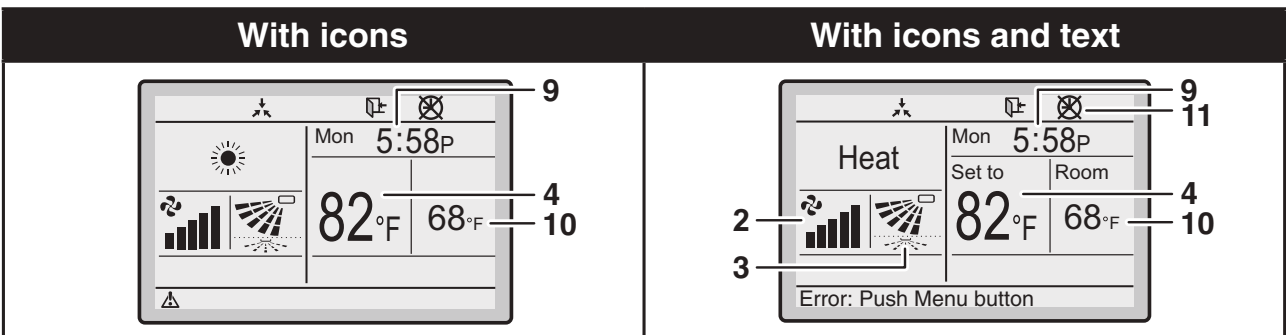

Detailed display

- The clock and Detailed selection items appear on the Detailed display in addition to the items appearing on the Standard display.



1. Operation mode

- Indicates the current operation mode.

Operation Mode		
Cool	Heat	Auto (Heat)
		
Fan	Dry	Auto (Cool)
		

2. Fan Speed

- Indicates the fan speed that is set for the air conditioner.
- The fan speed will not be displayed if the air conditioner does not have the fan speed control function.

3. Airflow direction

- Displayed only when the air conditioner is in operation.
- Indicates the airflow direction that is set for the air conditioner.
- The possible directions depend on the indoor unit.

4. Set/Setback temperature display

- When the unit is turned ON, the temperature that is set for the air conditioner is displayed.
- When the unit is turned OFF and Setback is disabled, the temperature that is set for the air conditioner is displayed.
- When the unit is turned OFF and Setback is enabled, the temperature that is set for the setback function is displayed in smaller digits.

5. Error “”

- Indicates a unit error.

6. Timer enabled “”

- Indicates that the schedule timer or the OFF timer is enabled.

7. Under Centralised control “”

- Indicates that the air conditioner is under the management of central control equipment (optional accessories) and the operation of the system through the remote controller is prohibited.

8. Setback “”

- The setback icon flashes when the unit is turned on under the setback control.

9. Clock (12/24 hours real time clock)

- Indicates that the clock is set.
- If the clock is not set, “ -- : -- ” will be displayed.

10. Detailed selection

- Displayed when the detailed display mode is selected.
- No detailed items are selected by default.

11. Timer problem “”

- Indicates that the clock needs to be set again.
- The schedule timer function will not work unless the clock is set again.

6. BRC944B2

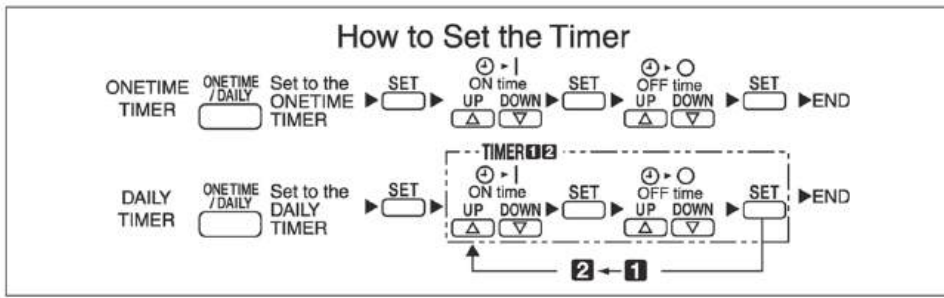
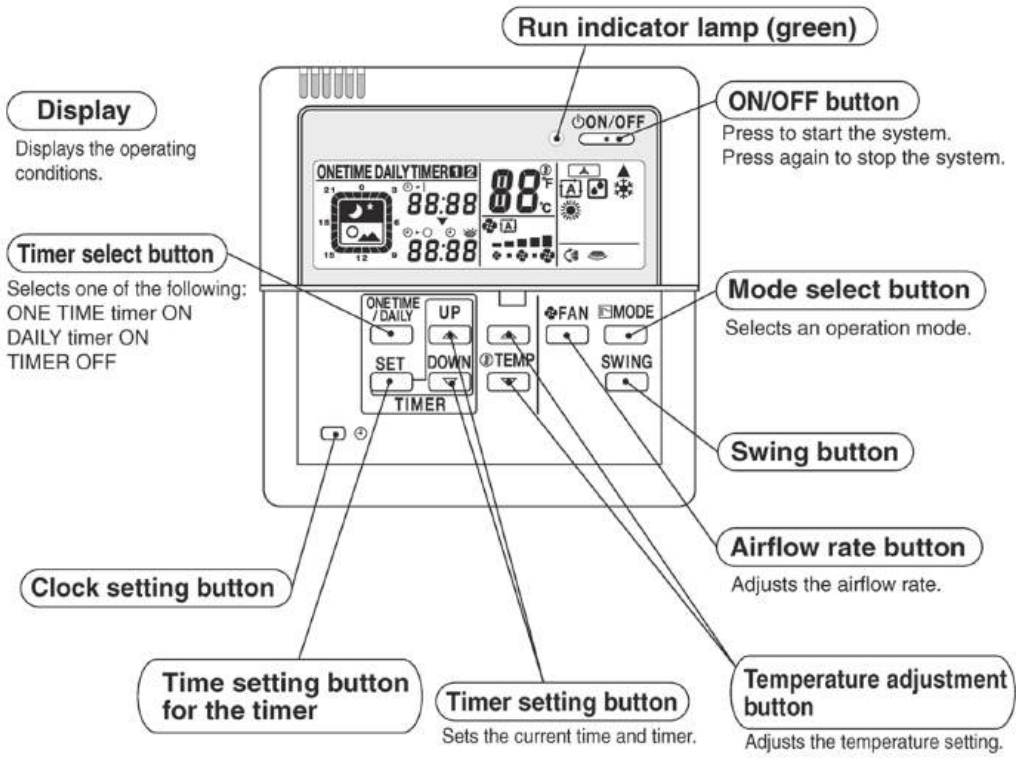

R5000214



Caution This remote controller cannot be used together with a standard wireless remote controller. Otherwise, what appears on this remote controller's display may fail to correspond to actual operating conditions.

7. Daikin One Thermostat

Refer to the following link for details.
<https://daikincomfort.com/pro>

Part 6

Service Diagnosis

1. General Problem Symptoms and Check Items	156
2. Troubleshooting with LED	157
2.1 Indoor Unit.....	157
2.2 Outdoor Unit.....	158
3. Service Diagnosis	159
3.1 BRC1NRV71	159
3.2 ARC466 Series.....	161
3.3 ARC480 Series.....	164
3.4 BRC073A6	167
4. Code Indication on Remote Controller	169
4.1 Indoor Unit.....	169
4.2 Outdoor Unit.....	170
5. Troubleshooting for Wall Mounted Type	171
5.1 Indoor Unit PCB Abnormality	171
5.2 Freeze-up Protection Control/Heating Peak-cut Control	172
5.3 Indoor Fan Motor (DC Motor) or Related Abnormality	173
5.4 Indoor Heat Exchanger Thermistor or Related Abnormality.....	175
5.5 Room Temperature Sensor Abnormality/Humidity Sensor Abnormality	176
5.6 Signal Transmission Error (Between Indoor Unit and Outdoor Unit).....	177
5.7 Unspecified Voltage (Between Indoor Unit and Outdoor Unit).....	179
6. Troubleshooting for Duct Concealed Type.....	180
6.1 External Protection Device Abnormality	180
6.2 Refrigerant Leak Detection (Confirmed).....	181
6.3 Refrigerant Leak Detection (Monitoring)	183
6.4 Indoor Unit PCB Abnormality	184
6.5 Drain Level Control System Abnormality.....	185
6.6 Indoor Fan Motor (DC Motor) or Related Abnormality	186
6.7 Indoor Fan PCB Abnormality.....	188
6.8 Humidifier or Related Abnormality.....	189
6.9 Defective Capacity Setting	190
6.10 Transmission Abnormality between Indoor Unit Control PCB and Fan PCB.....	191
6.11 Thermistor or Related Abnormality.....	193
6.12 Refrigerant Leak Detection Sensor Failure	194
6.13 Refrigerant Leak Detection Sensor Disconnection.....	195
6.14 Remote Controller Thermistor Abnormality	196
6.15 Signal Transmission Error (Between Indoor Unit and Outdoor Unit)....	197
6.16 Signal Transmission Error (Between Indoor Unit and Remote Controller).....	199

6.17	Signal Transmission Error (Between MAIN/SUB Remote Controllers).....	200
6.18	Unspecified Voltage (Between Indoor Unit and Outdoor Unit)	201
6.19	Address Duplication of Centralized Controller.....	202
7.	Troubleshooting for Floor Standing Type.....	203
7.1	Refrigerant Leak Detection.....	203
7.2	Indoor Unit PCB Abnormality	208
7.3	Freeze-up Protection Control/Heating Peak-cut Control	210
7.4	Indoor Fan Motor (DC Motor) or Related Abnormality	211
7.5	Thermistor or Related Abnormality (Indoor Unit).....	212
7.6	Room Temperature Sensor Abnormality/Humidity Sensor Abnormality	213
7.7	Refrigerant Leak Detection Sensor Failure or Disconnection	214
7.8	Low-voltage Detection or Over-voltage Detection.....	215
7.9	Signal Transmission Error (Between Indoor Unit and Outdoor Unit)....	217
7.10	Unspecified Voltage (Between Indoor Unit and Outdoor Unit).....	219
8.	Troubleshooting for Air Handling Units	220
8.1	External Protection Device Abnormality	220
8.2	Refrigerant Leak Detection (Confirmed) (CMXV Only)	221
8.3	Refrigerant Leak Detection (Monitoring)	222
8.4	Indoor Unit PCB Abnormality	223
8.5	Blower Motor Not Running	224
8.6	Indoor Fan Motor Status Abnormality.....	225
8.7	Low Indoor Airflow.....	226
8.8	Defective Capacity Setting	227
8.9	Blower Motor Communication Error	228
8.10	Thermistor/Pressure Sensor or Related Abnormality.....	229
8.11	Blower Motor HP Mismatch.....	230
8.12	Refrigerant Leak Detection Sensor Failure (CMXV Only)	231
8.13	Refrigerant Leak Detection Sensor Disconnection (CMXV Only)	232
8.14	Signal Transmission Error (Between Indoor Unit and Outdoor Unit)....	233
8.15	Signal Transmission Error (Between Indoor Unit and Remote Controller).....	235
8.16	Unspecified Voltage (Between Indoor Unit and Outdoor Unit)	236
8.17	Incorrect Electric Heater Capacity Setting.....	237
9.	Troubleshooting for Outdoor Unit.....	238
9.1	Refrigerant Shortage	238
9.2	Low-voltage Detection or Over-voltage Detection.....	241
9.3	Wiring Error Check Unexecuted.....	243
9.4	Unspecified Voltage (Between Indoor Unit and Outdoor Unit), Anti-icing Control in Other Rooms.....	244
9.5	Anti-icing Control for Indoor Unit	245
9.6	Outdoor Unit PCB Abnormality.....	247
9.7	Actuation of High Pressure Switch	248
9.8	OL Activation (Compressor Overload)	249
9.9	Compressor Lock	251
9.10	DC Fan Lock	253
9.11	Input Overcurrent Detection	254
9.12	Electronic Expansion Valve Coil Abnormality.....	256
9.13	Four Way Valve Abnormality.....	257
9.14	Discharge Pipe Temperature Control.....	259
9.15	High Pressure Control in Cooling	260

9.16 System Shutdown due to Temperature Abnormality in the Compressor	262
9.17 Compressor Sensor System Abnormality	263
9.18 High Pressure Switch System Abnormality	265
9.19 Position Sensor Abnormality	266
9.20 Thermistor or Related Abnormality (Outdoor Unit).....	268
9.21 High Pressure Sensor Abnormality	270
9.22 Electrical Box Temperature Rise	271
9.23 Radiation Fin Temperature Rise	273
9.24 Output Overcurrent Detection	275
10. Check	278
10.1 Thermistor Resistance Check	278
10.2 Indoor Fan Motor Connector Check	279
10.3 Power Supply Waveform Check.....	281
10.4 Electronic Expansion Valve Check.....	281
10.5 Four Way Valve Performance Check	282
10.6 Inverter Unit Refrigerant System Check.....	283
10.7 Inverter Analyzer Check	283
10.8 Outdoor Fan Motor Check.....	285
10.9 Installation Condition Check.....	286
10.10 Discharge Pressure Check.....	286
10.11 Outdoor Fan System Check	287
10.12 Main Circuit Short Check	287
10.13 Capacitor Voltage Check	289
10.14 Power Module Check.....	290
10.15 High Pressure Sensor Check	292
10.16 Fan Motor Connector Check for CMXV Models	292
10.17 Network Troubleshooting (CMXV Only).....	296
10.18 Wiring for Daikin One Thermostat	296
10.19 Pressure Sensor Voltage Check.....	297
10.20 Transformer Check (CMXV Only).....	297
10.21 Duct Static Pressure Check (CMXV Only).....	298

1. General Problem Symptoms and Check Items

Symptom	Check Item	Details	Reference Page
None of the units operates.	Check the power supply.	Check if the rated voltage is supplied and check wiring diagrams and specifications.	—
	Check the types of the indoor units.	Check if the indoor unit type is compatible with the outdoor unit.	—
	Check the outdoor temperature.	Heating/cooling operations are not available when the outdoor temperature is out of the operation limit. Check the reference page for the operation limit.	359
	Diagnose with remote controller indication	—	169, 170
	Check the wireless remote controller addresses.	Check if address settings for the wireless remote controller and indoor unit are correct.	311
	(CMXV Only) Check the transformer.	Check if the transformer receives and supplies the correct voltage.	297
Operation sometimes stops.	Check the power supply.	A power failure of 2 to 10 cycles can stop air conditioner operation. (Operation lamp OFF)	—
	Check the outdoor temperature.	Heating/cooling operations are not available when the outdoor temperature is out of the operation limit. Check the reference page for the operation limit.	359
	Diagnose with remote controller indication.	—	169, 170
(CMXV Only) The airflow rate does not match the set airflow.	Diagnose with thermostat indication.	Reset Field Setting.	327
Some indoor units do not operate.	Check the type of the indoor units.	Check if the indoor unit type is compatible with the outdoor unit.	—
	Diagnose with remote controller indication	—	169, 170
Units operate but do not cool, or do not heat.	Check for wiring and piping errors in the connection between the indoor and outdoor units.	Check the piping. Conduct the wiring error check described on the product diagnosis nameplate.	—
	Check for thermistor detection errors.	Check if the thermistor is mounted securely.	—
	Check for faulty operation of the electronic expansion valve.	Set all the units to cooling operation, and compare the temperatures of the liquid pipes to see if the each electronic expansion valve works.	—
	Diagnose with remote controller indication.	—	169, 170
	Diagnose by service port pressure and operating current.	Check for refrigerant shortage.	238
Large operating noise and vibrations	Check the installation condition.	Check if the required spaces for installation (specified in the installation manual) are provided.	—

2. Troubleshooting with LED

2.1 Indoor Unit

Operation Lamp

The operation lamp blinks when any of the following errors is detected.

1. When a protection device of the indoor or outdoor unit is activated, or when the thermistor malfunctions.
2. When a signal transmission error occurs between the indoor and outdoor units.

In either case, conduct the diagnostic procedure described in the following pages.

■ Wall mounted type

07/09/12 class

15/18/24 class

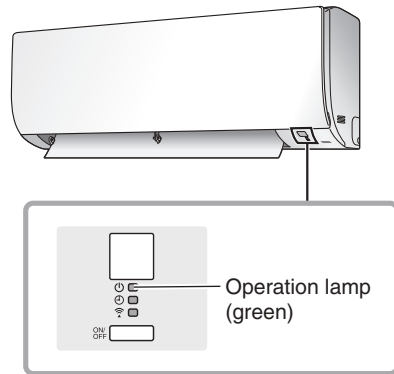

R6001149

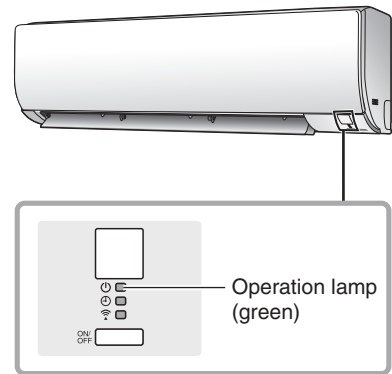

R6001150

■ Floor standing type

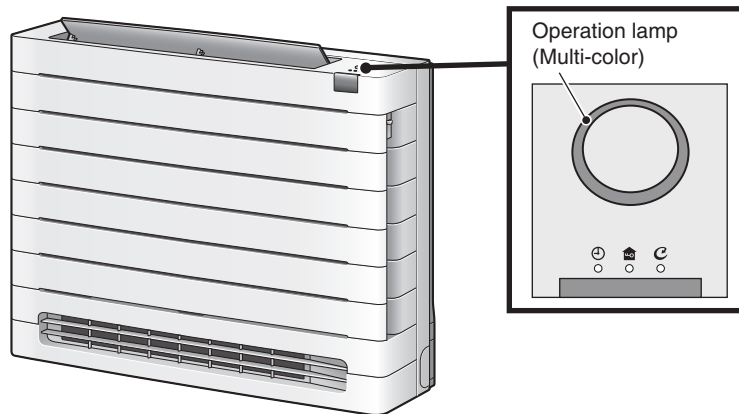

R4004068

■ Duct concealed type

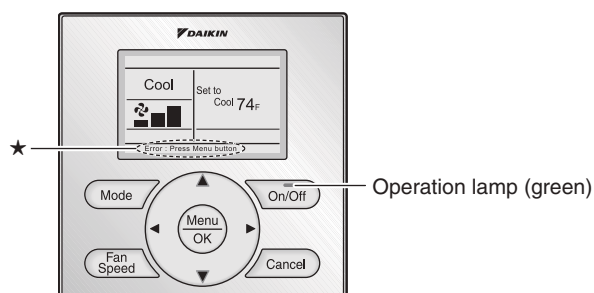

★The error or warning message also blinks on the basic screen.

R4003516

■ CMXV Series with Daikin One Thermostat

Refer to the following link for details.

<https://daikincomfort.com/pro>

Service Monitor

The indoor unit has a green LED (HAP) on the control PCB. When the microcomputer works in order, the LED blinks. (Refer to page 34 for the location of LED.)

2.2 Outdoor Unit

The outdoor unit has a green LED (LED A) and red LEDs (LED 1 ~ LED 5) on the PCB.

When the microcomputer works in order, the LED A blinks, and when the system is in normal condition, the red LEDs are OFF.

Even after the error is canceled and the unit operates in normal condition, the LED indication remains.

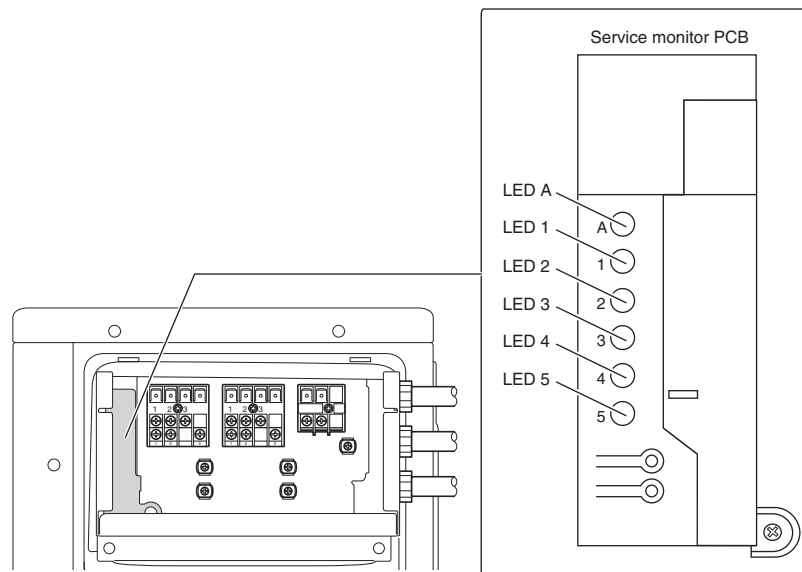

R6001151

★ This illustration is for the 4MXM-A series as a representative.



Reference

Refer to page 41 for the location of LED.

3. Service Diagnosis

3.1 BRC1NRV71

Relations Between Modes

On power-up, the message “**Checking the connection. Please standby.**” will be displayed on the remote controller screen temporarily and then the basic screen will be displayed. To access a mode from the basic screen, refer to the figure below.

When any of the operation buttons is pressed, the backlight will come on and remain lit for about 30 seconds. Be sure to press a button while the backlight is on.

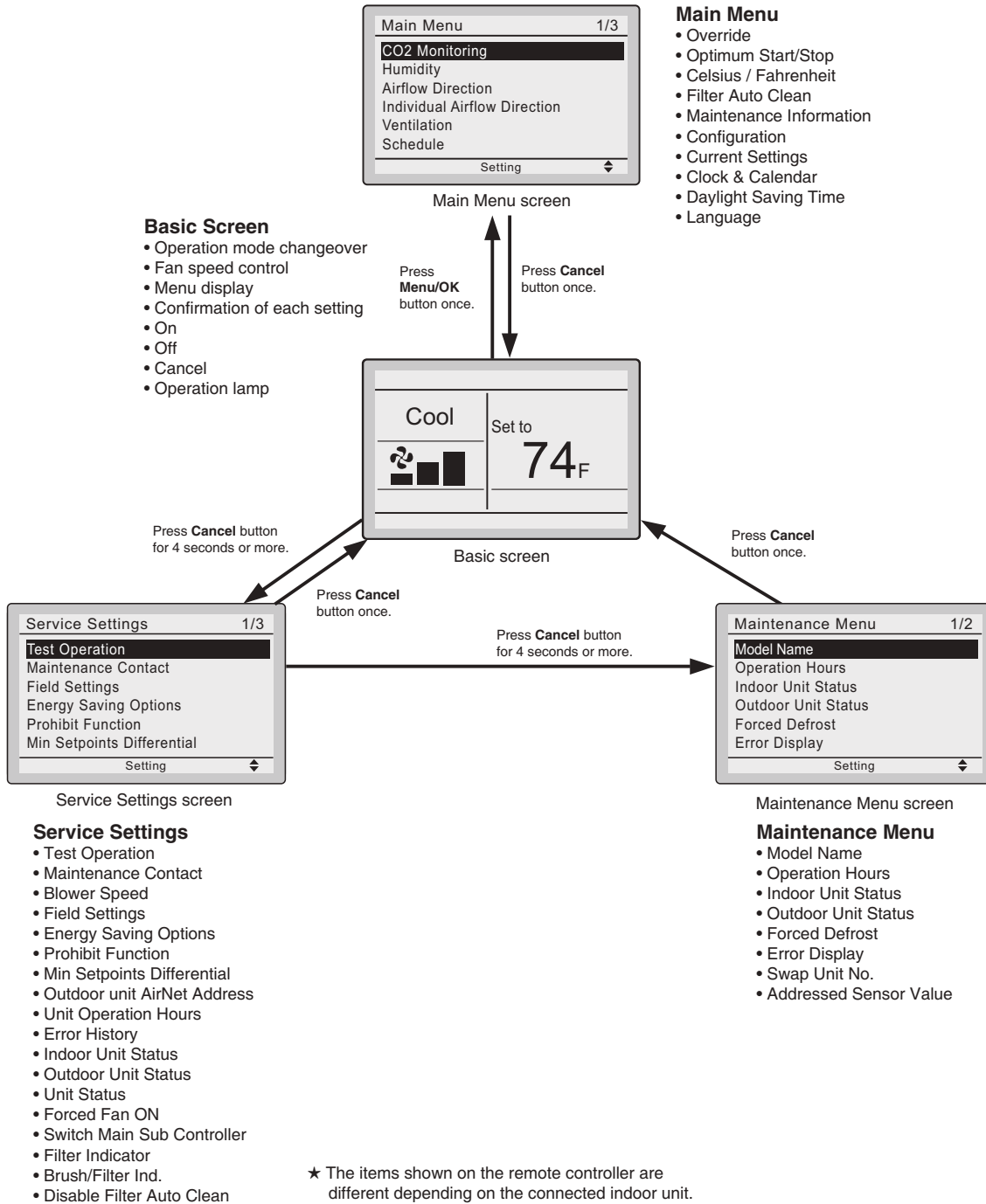

R6001318

Service Diagnosis

The following message is displayed on the screen when an error (or a warning) occurs during operation.

Check the error code and take the corrective action specified for the particular model.

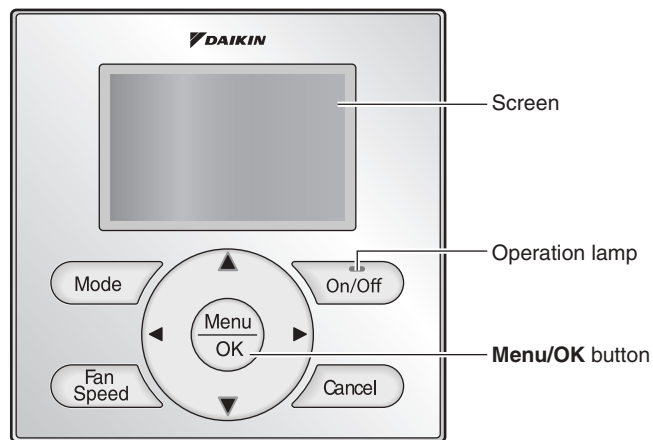

(R18817)

Operation

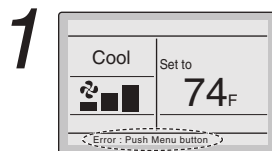

- If an error occurs, either one of the following items will flash in the basic screen.

Error: Push Menu button

- * The Operation lamp will flash.
- * For Simple display, the message is not displayed, and only the Operation lamp flashes.

Warning: Push Menu button

- * The Operation lamp will not flash.
- * For Simple display, the message is not displayed, and the Operation lamp does not flash, either.

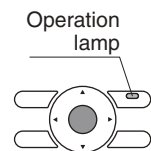

- Press **Menu/OK** button.

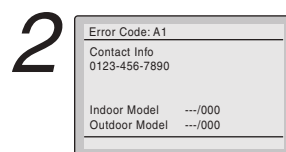

- The error code will flash and the service contact and model name or code may be displayed.
- Notify your Daikin dealer of the Error code and model name or code.

3.2 ARC466 Series

3.2.1 Method 1

1. When **Timer cancel** button is held down for 5 seconds, **00** is displayed on the temperature display screen.
2. Press **Timer cancel** button repeatedly until a long beep sounds.

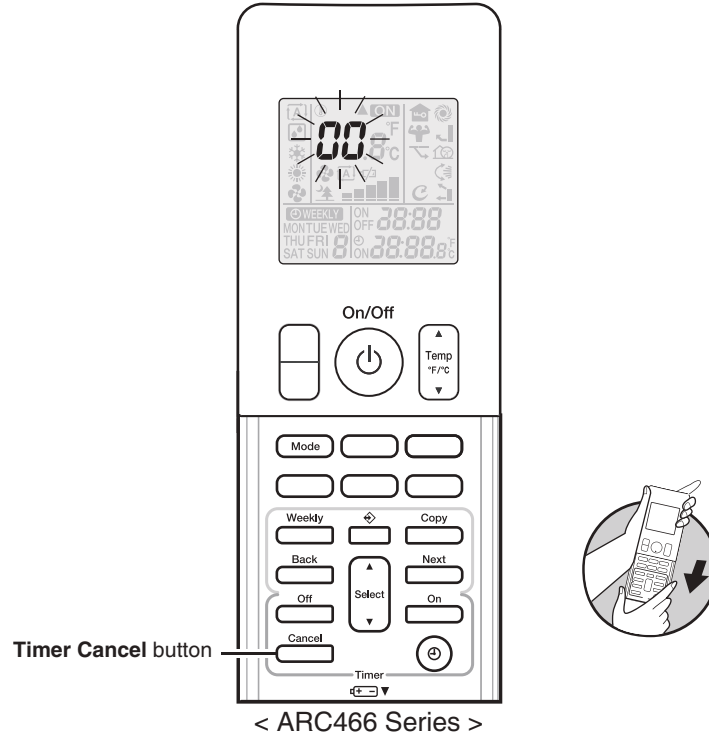

i Notes

1. A short beep and two consecutive beeps indicate non-corresponding codes.
2. To return to the normal mode, hold **Timer cancel** button down for 5 seconds. When the remote controller is left untouched for 60 seconds, it also returns to the normal mode.
3. Not all the error codes are displayed. When you cannot find the error code, try method 2. Refer to page 162.

■ The code indication changes in the sequence shown below.

ARC466A89

No.	Code	No.	Code	No.	Code
1	00	16	A3	31	U3
2	A5	17	H8	32	UF
3	E7	18	H9	33	UH
4	F3	19	C9	34	P4
5	F6	20	CC	35	H7
6	L3	21	C4	36	U2
7	L4	22	C5	37	EA
8	L5	23	CH	38	AH
9	U4	24	J3	39	FA
10	E6	25	J6	40	E3
11	H6	26	J8	41	H3
12	H0	27	E5	42	F8
13	A6	28	A1	43	A0
14	U0	29	E1	—	—
15	C7	30	UA	—	—

3.2.2 Method 2

1. Press the center of **Temp** button and **Mode** button at the same time.

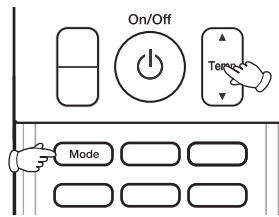

SC is displayed on the LCD.

R6000191

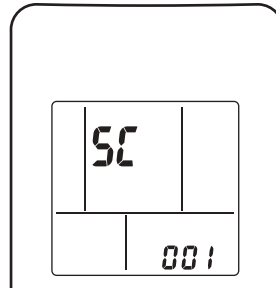

2. Select **SC** (service check) with **Temp Up** or **Temp Down** button.
3. Press **Mode** button to enter the service check mode.

R6001137

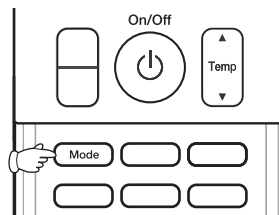

The left-side number blinks.

R6000192

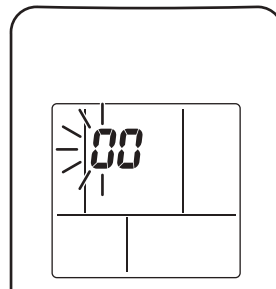

4. Press **Temp Up** or **Temp Down** button and change the number until you hear the two consecutive beeps or the long beep.

R6001138

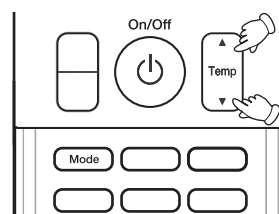

5. Diagnose by the sound.

R6000193

- Beep: The left-side number does not correspond with the error code.
- Two consecutive beeps: The left-side number corresponds with the error code but the right-side number does not.

- Long beep: Both the left-side and right-side numbers correspond with the error code. The numbers indicated when you hear the long beep are the error code. Refer to page 169.

6. Press **Mode** button.

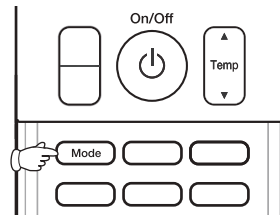

The right-side number blinks.

R6000192

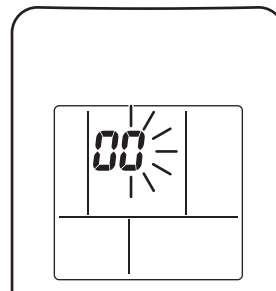

7. Press **Temp Up** or **Temp Down** button and change the number until you hear the long beep.

R6001139

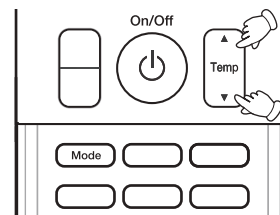

R6000193

8. Diagnose by the sound.

- Beep: The left-side number does not correspond with the error code.
- Two consecutive beeps: The left-side number corresponds with the error code but the right-side number does not.
- Long beep: Both the left-side and right-side numbers correspond with the error code.

9. Determine the error code.

The numbers indicated when you hear the long beep are the error code. Refer to page 169.

10. Press **Mode** button for 5 seconds to exit from the service check mode.

When the remote controller is left untouched for 60 seconds, it returns to the normal mode also.

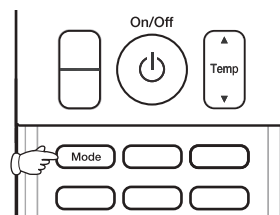

R6000192

3.3 ARC480 Series

3.3.1 Method 1

1. When **TIMER CANCEL** button is held down for 5 seconds, **00** is displayed on the temperature display screen.
2. Press **TIMER CANCEL** button repeatedly until a long beep sounds.

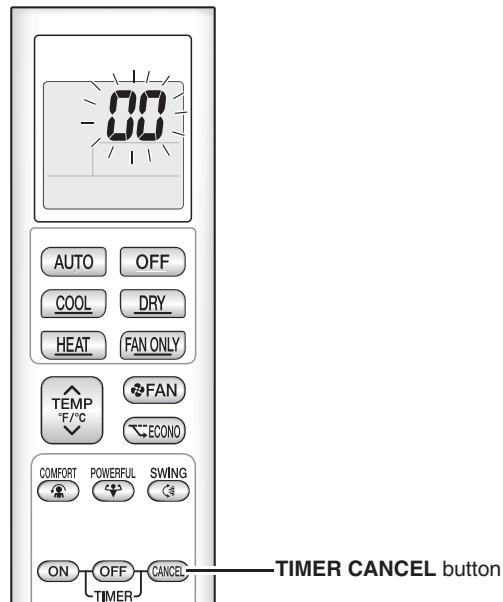

< ARC480 Series >

R6001152



Note(s)

1. A short beep or two consecutive beeps indicate non-corresponding codes.
2. To return to the normal mode, hold **TIMER CANCEL** button down for 5 seconds. When the remote controller is left untouched for 60 seconds, it also returns to the normal mode.
3. Not all the error codes are displayed. When you cannot find the error code, try method 2. Refer to page 165.

- The code indication changes in the sequence shown below.

ARC480A83

No.	Code	No.	Code	No.	Code
1	00	16	A3	31	UF
2	A5	17	H8	32	UH
3	E7	18	H9	33	P4
4	F3	19	C9	34	H7
5	F6	20	CC	35	U2
6	L3	21	C4	36	EA
7	L4	22	C5	37	AH
8	L5	23	J3	38	E9
9	U4	24	J6	39	FA
10	E6	25	J8	40	E8
11	H6	26	E5	41	CH
12	H0	27	A1	42	J9
13	A6	28	E1	43	E3
14	U0	29	UA	44	H3
15	C7	30	U3	45	F8

3.3.2 Method 2

1. Press the center of **TEMP** button and **OFF** button at the same time.

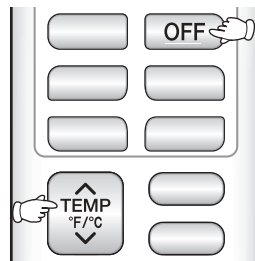

SC is displayed on the LCD.

R6001161

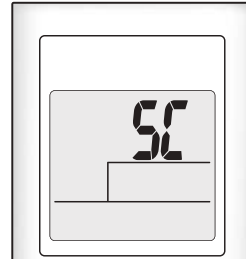

2. Select **SC** (service check) with **TEMP ▲** or **TEMP ▼** button.
3. Press **FAN** button to enter the service check mode.

R6001158

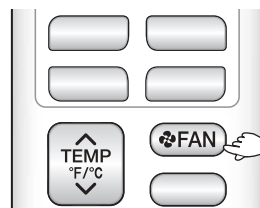

00 is displayed and the left-side number blinks.

R6001162

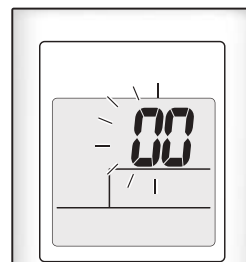

4. Press **TEMP ▲** or **TEMP ▼** button and change the number until you hear the two consecutive beeps or the long beep.

R6001159

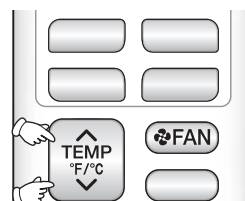

5. Diagnose by the sound.

R6001163

- Beep: The left-side number does not correspond with the error code.
- Two consecutive beeps: The left-side number corresponds with the error code but the right-side number does not.
- Long beep: Both the left-side and right-side numbers correspond with the error code. The numbers indicated when you hear the long beep are the error code. Refer to Error codes and description on page 169.

6. Press **FAN** button.

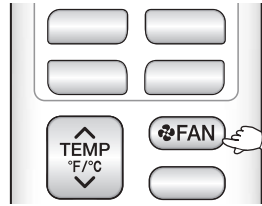

The right-side number blinks.

R6001162

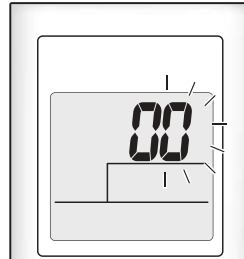

7. Press **TEMP ▲** or **TEMP ▼** button and change the number until you hear the long beep.

R6001160

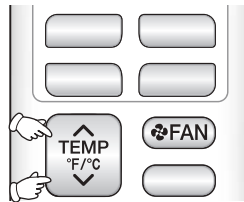

R6001163

8. Diagnose by the sound.

- Beep: The left-side number does not correspond with the error code.
- Two consecutive beeps: The left-side number corresponds with the error code but the right-side number does not.
- Long beep: Both the left-side and right-side numbers correspond with the error code.

9. Determine the error code.

The numbers indicated when you hear the long beep are the error code.
Refer to Error codes and description on page 169.

10. Press **FAN** button for 5 seconds to exit from the service check mode.

When the remote controller is left untouched for 60 seconds, it returns to the normal mode also.

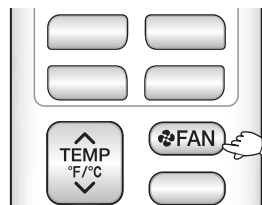

R6001162

3.4 BRC073A6

**Relations
Between Modes**

On power-up, the message “**Checking the connection. Please standby.**” will be displayed on the remote controller screen temporarily and then the basic screen will be displayed. To access a mode from the basic screen, refer to the figure below.

When any of the operation buttons are pressed, the backlight will come on and remain lit for about 30 seconds. Be sure to press a button while the backlight is on.

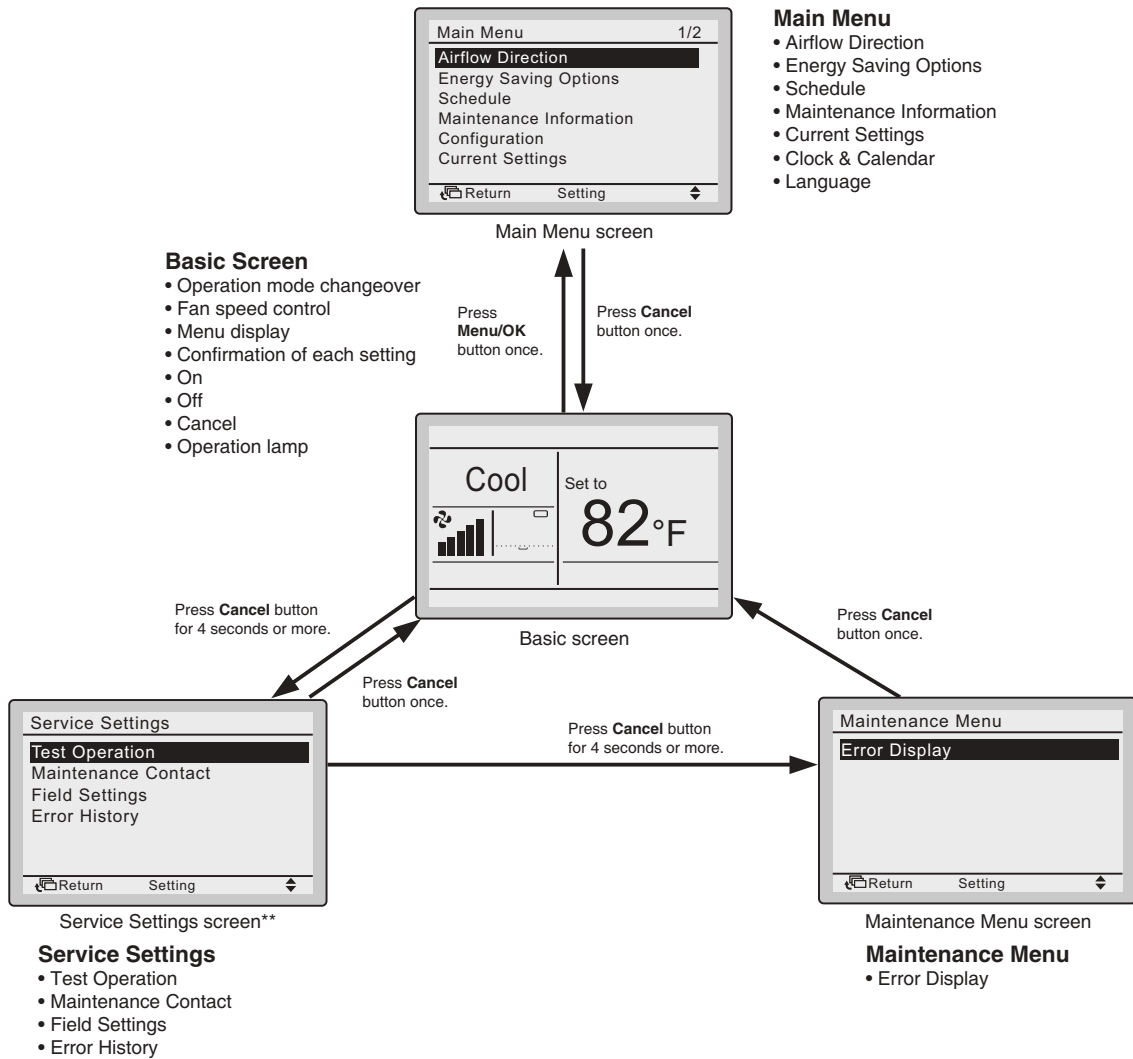

★ The items shown on the remote controller are different depending on the connected indoor unit.
 ** Not displayed in multi-split system.

Service Diagnosis

The following message is displayed on the screen when an error occurs during operation. Check the error code and take the corrective action specified for the particular model.

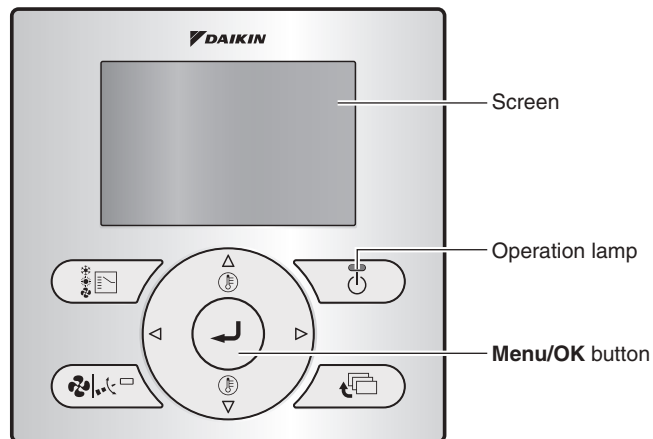

Operation Method

1

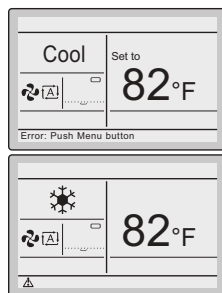

- If an error occurs, the error message or error icon and the operation lamp will blink.
- To display the error code and contact information, the Menu/Enter button needs to be enabled.
- Press the Menu/Enter button.

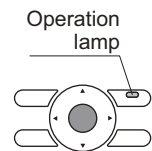

2

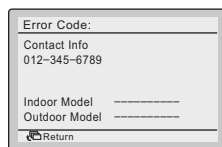

- The error code blinks and the contact address will appear.
- Notify your Daikin dealer of the Error code and Model name.

4. Code Indication on Remote Controller

4.1 Indoor Unit

Error Codes	Description	Reference Page			
		CTXV FTXV	CDMA FDMA	FVXV	CMXV
00	Normal condition	—	—	—	—
A0	Refrigerant leak detection	—	—	203	—
A0-01	External protection device abnormality	—	180	—	220
A0-17, A0-19	Refrigerant leak detection	—	181, 183	—	221, 222
A1	Indoor unit PCB abnormality	171	184	208	223
A3	Drain level control system abnormality	—	185	—	—
A5	Freeze-up protection control/heating peak-cut control	172	—	210	—
A6	Indoor fan motor (DC motor) or related abnormality	173	186	211	225
A6	Blower Motor Not Running	—	—	—	224
A8	Indoor fan PCB abnormality	—	188	—	—
AF	Humidifier or related abnormality	—	189	—	—
AJ	Capacity setting error	—	190	—	227
C1	Transmission abnormality between indoor unit PCB and fan PCB	—	191	—	—
C1	Blower Motor Communication Error	—	—	—	228
C4, C5	Indoor heat exchanger thermistor or related abnormality	175	193	212	229
C6	Blower Motor HP Mismatch	—	—	—	230
C9	Room temperature sensor or related abnormality	176	193	—	229
C9 (C922)	Room temperature thermistor or related abnormality	—	—	212	—
C9 (C921)	Room temperature sensor or related abnormality	—	—	213	—
CC	Humidity sensor abnormality	176	—	176	—
CH	Refrigerant leak detection sensor failure or disconnection	—	—	214	—
CH-11	Refrigerant leak detection sensor failure	—	194	—	231
CH-14	Refrigerant leak detection sensor disconnection	—	195	—	232
CJ	Remote controller thermistor abnormality	—	196	—	—
U4	Signal transmission error (between indoor unit and outdoor unit)	177	197	217	233
U5	Signal transmission error (between indoor unit and remote controller)	—	199	—	235
U8	Signal transmission error (between MAIN/SUB remote controller)	—	200	—	—
UA	Unspecified voltage (between indoor unit and outdoor unit)	179	201	219	236
UA-17	Incorrect Electric Heater Capacity Setting	—	—	—	237
UC	Address duplication of centralized controller	—	202	—	—
UF	Wrong wiring check error	—	—	—	—

4.2 Outdoor Unit

☀: ON, ●: OFF, ⚡: Blinks

Outdoor Unit LED Indication						Error Codes	Description	Reference Page
Green	Red							
A	1	2	3	4	5			
						00	Normal condition	—
⚡	●	●	●	●	●	UA	Unspecified voltage (between indoor unit and outdoor unit)	244
						UH	Anti-icing control in other rooms	244
⚡	●	●	☀	☀	●	(U0)	Refrigerant shortage	238
⚡	☀	●	●	☀	●	U2	Low-voltage detection or over-voltage detection	241
⚡	●	☀	●	●	●	U3	Wiring error check unexecuted	243
⚡	☀	●	☀	☀	●	A5	Anti-icing control for indoor unit	245
⚡	☀	☀	☀	●	●	E1	Outdoor unit PCB abnormality	247
⚡	☀	●	●	●	●	E3	Actuation of high pressure switch	248
⚡	☀	●	☀	●	●	(E5)	OL activation (compressor overload)	249
⚡	●	☀	☀	●	●	(E6)	Compressor lock	251
⚡	☀	☀	☀	☀	●	E7	DC fan lock	253
⚡	●	☀	●	☀	●	E8	Input overcurrent detection	253
⚡	●	●	●	●	☀	E9	Electronic expansion valve abnormality	256
⚡	☀	●	●	●	●	EA	Four way valve abnormality	257
⚡	☀	●	☀	●	●	F3	Discharge pipe temperature control	259
⚡	☀	●	☀	☀	●	F6	High pressure control in cooling	260
⚡	●	●	☀	☀	●	F8	System shutdown due to temperature abnormality in the compressor	262
⚡						H0	Master circuit malfunction	263
						H3	High pressure switch system abnormality	265
						H6	Position sensor abnormality	266
						H9	Outdoor temperature thermistor or related abnormality	268
⚡	☀	☀	●	●	●	JA	High pressure sensor abnormality	270
						(J3)	Discharge pipe thermistor or related abnormality	268
						J6	Outdoor heat exchanger thermistor or related abnormality	268
						J8	Liquid pipe thermistor or related abnormality	268
						J9	Gas pipe thermistor or related abnormality	268
						P4	Radiation fin thermistor or related abnormality	268
⚡	☀	☀	●	☀	●	L3	Electrical box temperature rise	271
⚡	●	●	●	☀	●	L4	Radiation fin temperature rise	273
⚡	●	●	☀	●	●	L5	Output overcurrent detection	275
☀	—	—	—	—	—	—	See the note 4.	—
●	—	—	—	—	—	—	Check the power supply.	—

Notes

- The error codes in the parenthesis () are displayed only when the system is shut down.
- When a sensor error occurs, check the remote controller display to determine which sensor is malfunctioning.
If the remote controller does not indicate the error code, conduct the following procedure.
 - Turn the power off and then on again. If the same LED indication appears again immediately after the power is turned on, the fault is in the thermistor.
 - If the above condition does not result, the fault is in the CT.
- The indoor unit error code may take the precedence in the remote controller display.
- Turn the power off and then on again. If the same LED indication appears again, outdoor unit PCB is faulty. Replace the outdoor unit PCB.

5. Troubleshooting for Wall Mounted Type

5.1 Indoor Unit PCB Abnormality

Error Code	A1
Method of Error Detection	The system checks if the circuit works properly within the microcomputer of the indoor unit.
Error Decision Conditions	The system cannot set the internal settings.
Supposed Causes	<ul style="list-style-type: none"> ■ Wrong models interconnected ■ Defective indoor unit PCB ■ Disconnection of connector ■ Reduction of power supply voltage

Troubleshooting

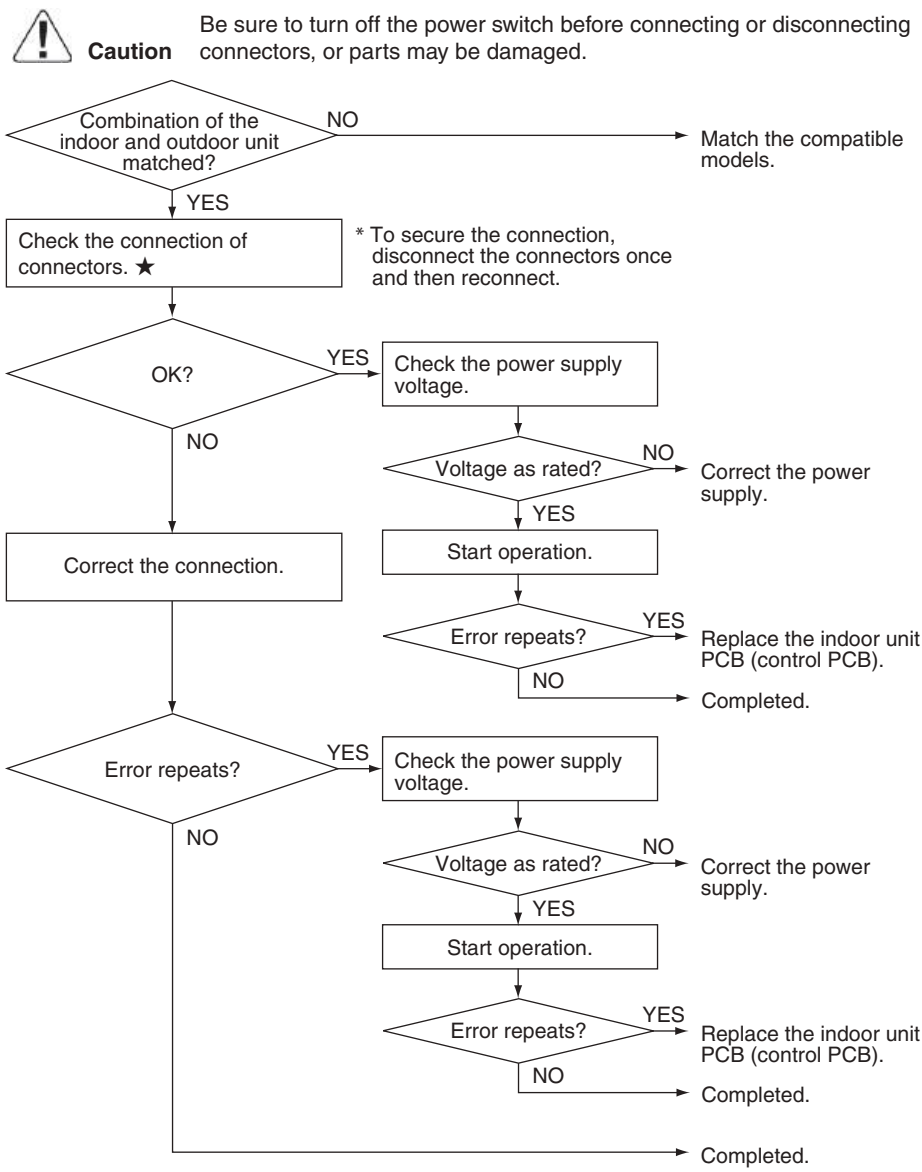

(R23407)



Note

★ Wire Harness (Connector): Terminal strip ~ Control PCB (S1)

5.2 Freeze-up Protection Control/Heating Peak-cut Control

Error Code	A5
Method of Error Detection	<ul style="list-style-type: none"> ■ Freeze-up protection control During cooling operation, the freeze-up protection control (operation halt) is activated according to the temperature detected by the indoor heat exchanger thermistor. ■ Heating peak-cut control During heating operation, the temperature detected by the indoor heat exchanger thermistor is used for the heating peak-cut control (operation halt, outdoor fan stop, etc.)
Error Decision Conditions	<ul style="list-style-type: none"> ■ Freeze-up protection control During cooling operation, the indoor heat exchanger temperature is below 0°C (32°F). ■ Heating peak-cut control During heating operation, the indoor heat exchanger temperature is above 59 ~ 60°C (138.2 ~ 140°F).
Supposed Causes	<ul style="list-style-type: none"> ■ Short-circuited air ■ Clogged air filter of the indoor unit ■ Dust accumulation on the indoor heat exchanger ■ Defective indoor heat exchanger thermistor ■ Defective indoor unit PCB

Troubleshooting

Caution

Be sure to turn off the power switch before connecting or disconnecting connectors, or parts may be damaged.

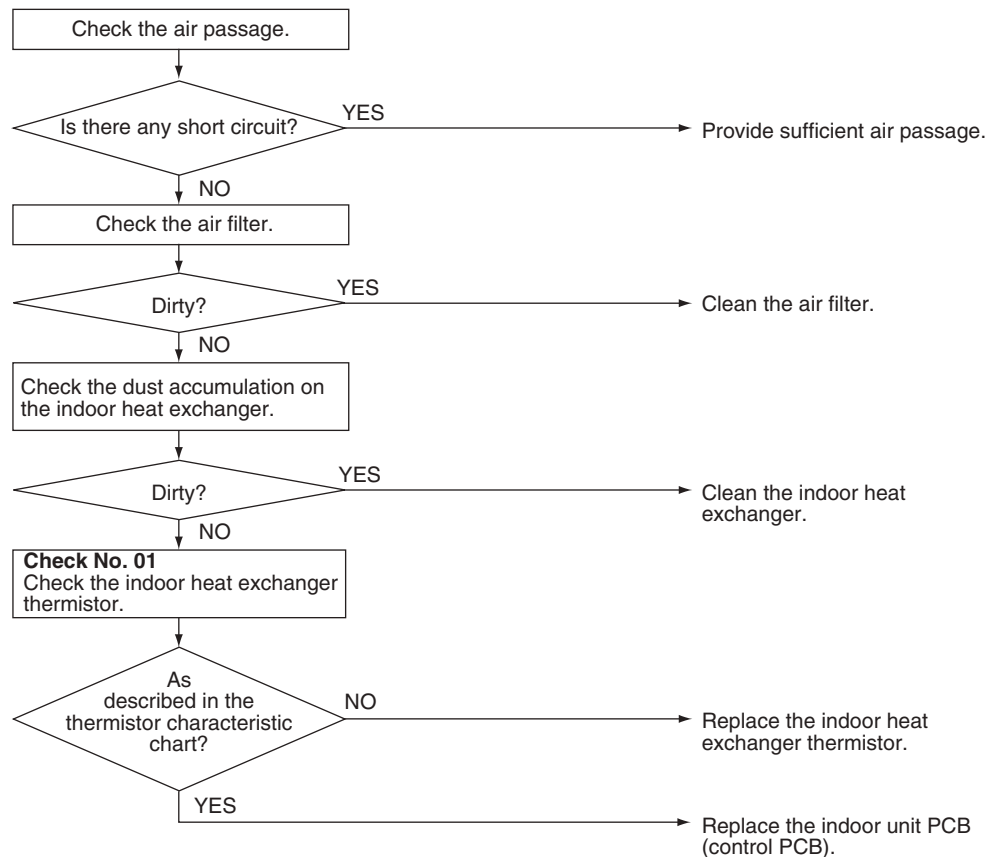

(R21064)



Reference

Check No.01 Refer to P.278

5.3 Indoor Fan Motor (DC Motor) or Related Abnormality

Error Code	A6
Method of Error Detection	The rotation speed detected by the Hall IC during fan motor operation determines abnormal fan motor operation.
Error Decision Conditions	The detected rotation speed does not reach the demanded rotation speed of the target tap, and is less than 50% of the maximum fan motor rotation speed.
Supposed Causes	<ul style="list-style-type: none"> ■ Remarkable decrease in power supply voltage ■ Layer short inside the fan motor winding ■ Breaking of wire inside the fan motor ■ Breaking of the fan motor lead wires ■ Defective capacitor of the fan motor ■ Defective indoor unit PCB

Troubleshooting

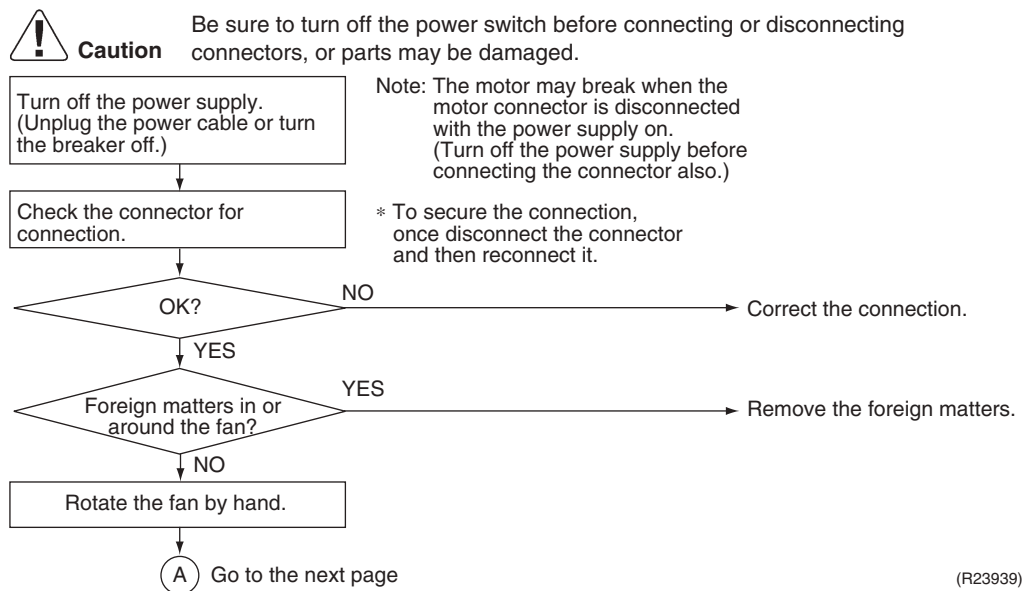

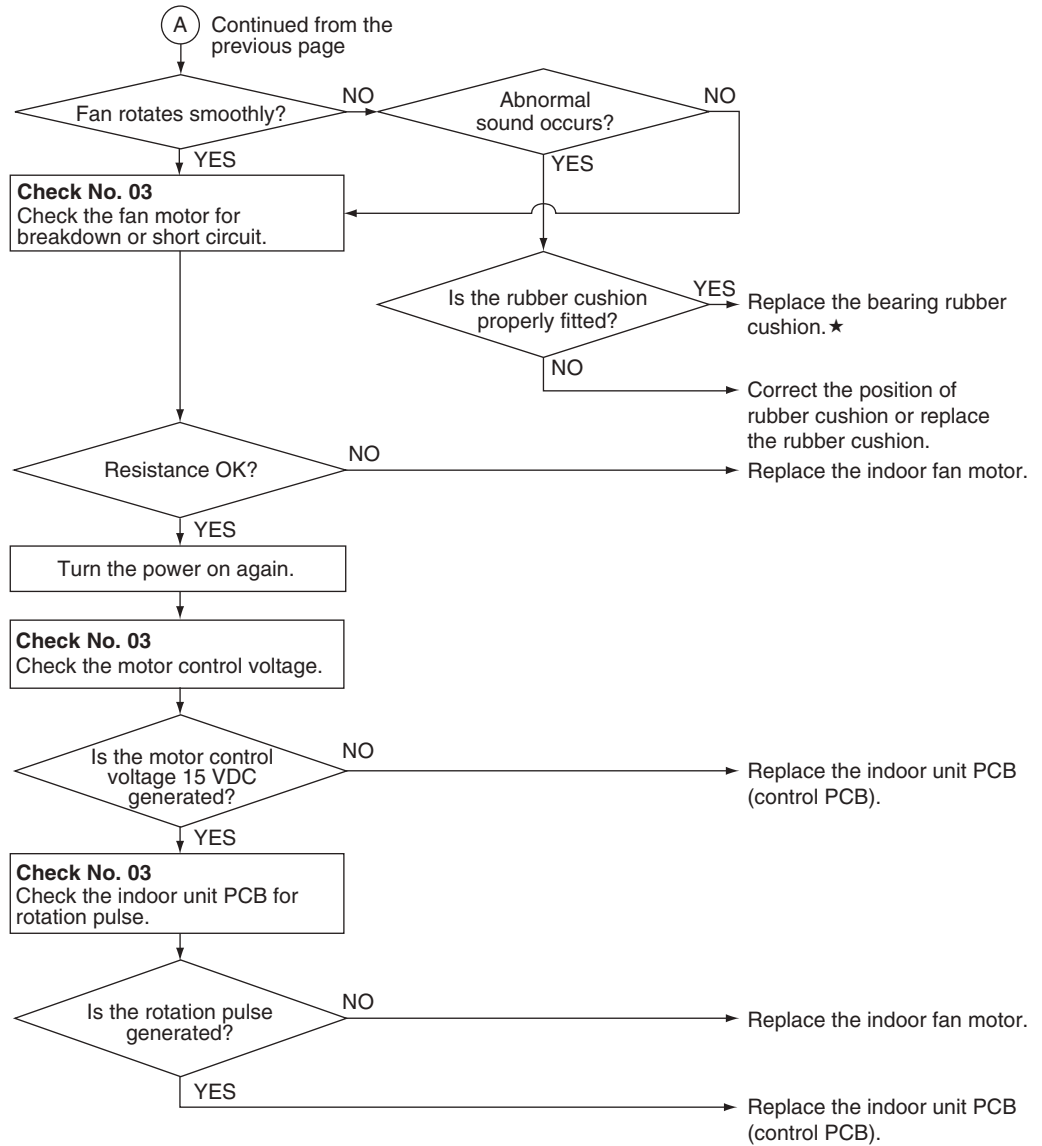

(R24945)

★Rubber cushion
07/09/12 class

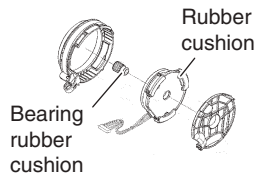

15/18/24 class

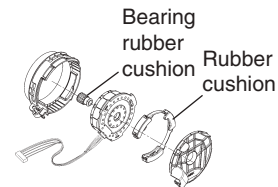

R6000581

R6000306



Reference

Check No.03 Refer to P.279

5.4 Indoor Heat Exchanger Thermistor or Related Abnormality

Error Code	C4
Method of Error Detection	The temperatures detected by the thermistors determine thermistor errors.
Error Decision Conditions	The voltage between the both ends of the thermistor is either 4.96 V or more, or 0.04 V or less with the power on.
Supposed Causes	<ul style="list-style-type: none"> ■ Disconnection of connector ■ Defective thermistor(s) ■ Defective indoor unit PCB

Troubleshooting

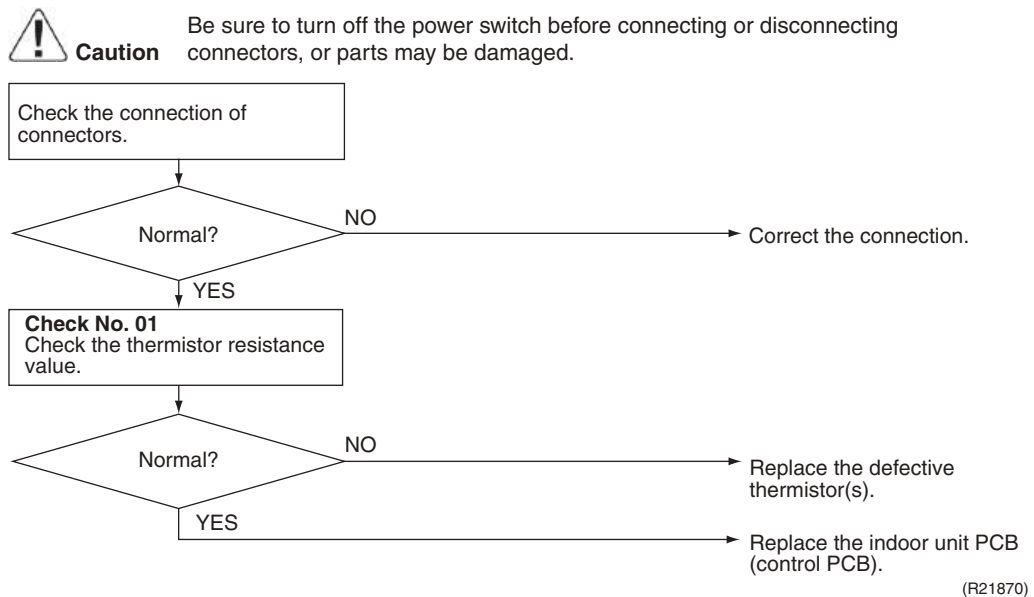

C4 : Indoor heat exchanger thermistor



Reference

Check No.01 Refer to P.278

5.5 Room Temperature Sensor Abnormality/Humidity Sensor Abnormality

Error Code

C9, CC

Method of Error Detection

Sensor abnormality is detected by input value.

Error Decision Conditions

The input from the humidity sensor is 4.96 V and more or 0.04 V and less.

Supposed Causes

- Disconnection of connector
- Defective humidity sensor
- Defective indoor unit PCB

Troubleshooting

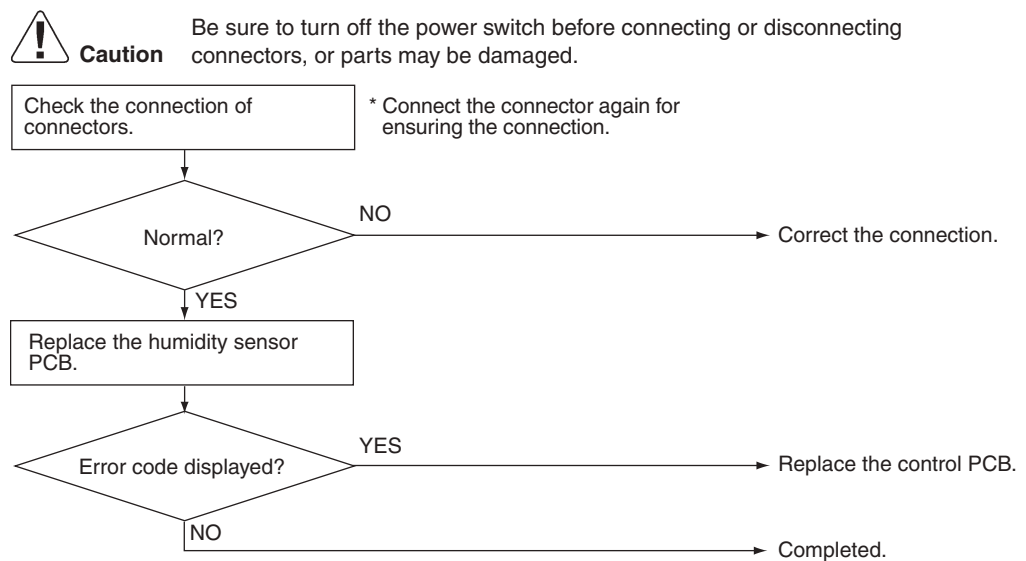

C9 : Room temperature sensor
CC : Humidity sensor

R6000515

5.6 Signal Transmission Error (Between Indoor Unit and Outdoor Unit)

Error Code	U4
Method of Error Detection	The signal transmission data received from the outdoor unit is checked whether it is normal.
Error Decision Conditions	The data sent from the outdoor unit cannot be received normally, or the content of the data is abnormal.
Supposed Causes	<ul style="list-style-type: none">■ Reduction of power supply voltage■ Wiring error■ Breaking of the connection wires between the indoor and outdoor units (wire No. 3)■ Defective outdoor unit PCB■ Short circuit inside the fan motor winding■ Defective indoor unit PCB■ Disturbed power supply waveform

Troubleshooting



Caution Be sure to turn off the power switch before connecting or disconnecting connectors, or parts may be damaged.

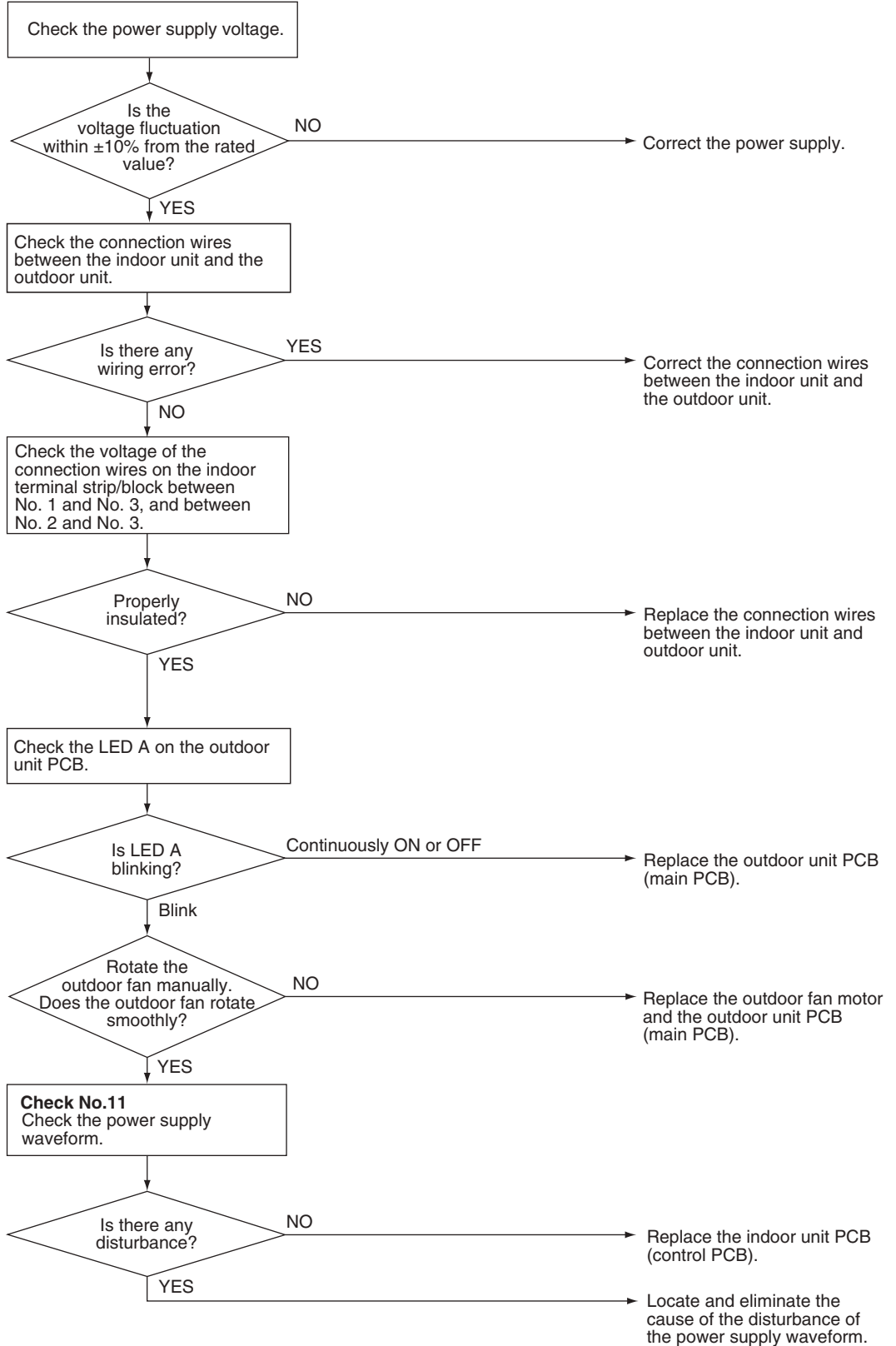

(R24621)



Reference

Check No.11 Refer to P.281

5.7 Unspecified Voltage (Between Indoor Unit and Outdoor Unit)

Error Code	UA
Method of Error Detection	The supply power is detected for its requirements (pair type is different from multi type) by the indoor/outdoor transmission signal.
Error Decision Conditions	The pair type and multi type are interconnected.
Supposed Causes	<ul style="list-style-type: none"> ■ Wrong models interconnected ■ Wrong wiring of connecting wires ■ Wrong indoor unit PCB or outdoor unit PCB mounted ■ Defective indoor unit PCB ■ Defective outdoor unit PCB

Troubleshooting

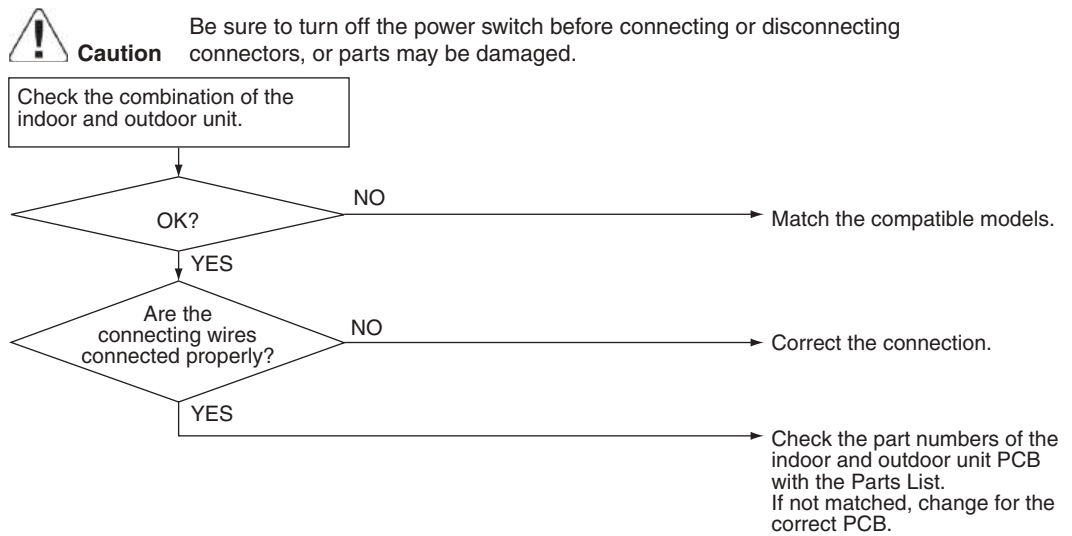

(R23001)

6. Troubleshooting for Duct Concealed Type

6.1 External Protection Device Abnormality

Error Code	A0-01
Method of Error Detection	Detect open or short circuit between external input terminals in indoor unit.
Error Decision Conditions	When an open circuit occurs between external input terminals.
Supposed Causes	<ul style="list-style-type: none"> ■ Open external input terminals (TB4-TB5) ■ Activation of external protection device ■ Defective indoor unit PCB ■ Indoor unit fuse blown ■ 24 VAC power is not supplied to TH2 and TR2 terminals on the indoor unit PCB.

Troubleshooting

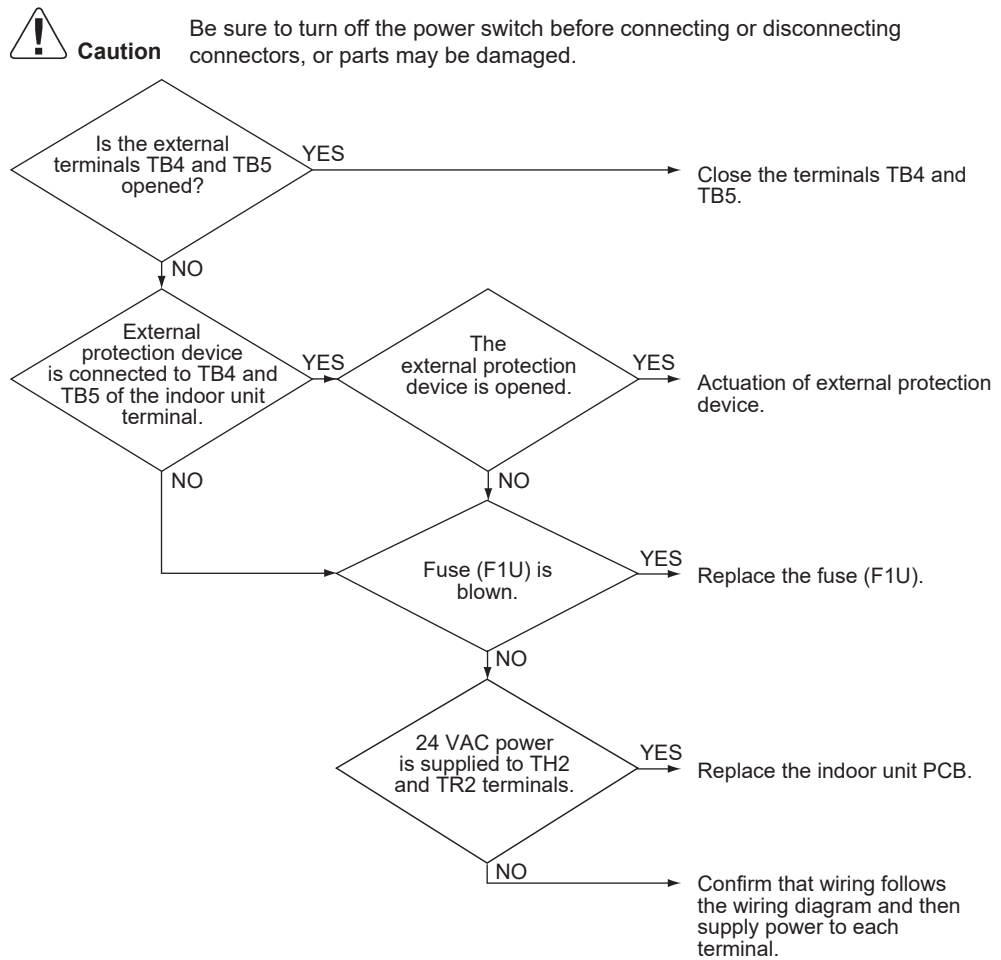

R6001347

6.2 Refrigerant Leak Detection (Confirmed)

Error Code	A0-17
Method of Error Detection	Refrigerant leak detection sensor detects a refrigerant leak for a long period of time.
Error Decision Conditions	When the A0-19 error detection status has occurred multiple times within a short period or continuously for a certain duration
Supposed Causes	<ul style="list-style-type: none"> ■ Refrigerant leak from system piping ■ Refrigerant leak detection sensor deterioration/failure ■ Defective A1P control PCB

Troubleshooting

-  **Caution**
- Be sure to turn off the power switch before connecting or disconnecting connectors, or parts may be damaged.
 - Refrigerant may be leaking.
 - Please check the refrigerant leaking in a well-ventilated environment to prevent accumulation.
 - Be careful to avoid generating fire or sparks.
 - While this error is being detected, the unit will operate the fan to disperse the refrigerant. Be sufficiently careful not to injure yourself.

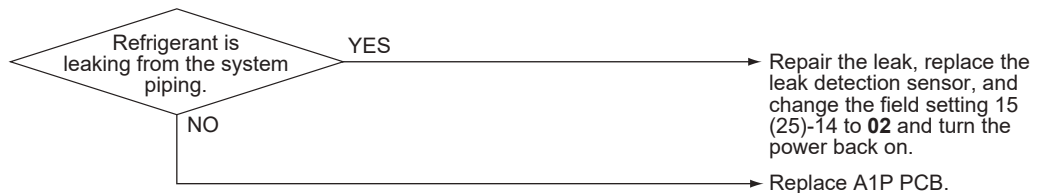

R6001341

Replacing the refrigerant sensor

1. Remove the 5 screws and then the service cover.

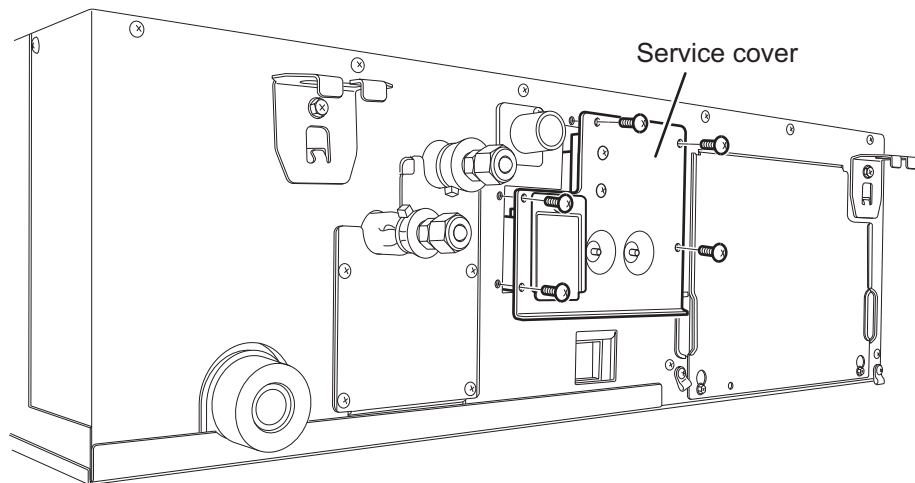

R6001348

2. Remove the screw and then the cover.

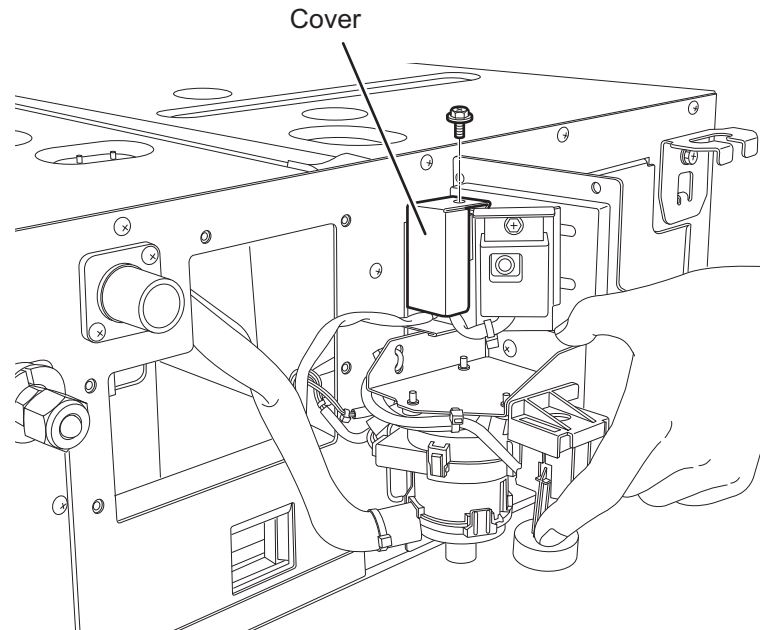

R6001349

3. Cut the 2 clamps.
Disconnect the relay connector.
Remove the screw and then the refrigerant sensor.

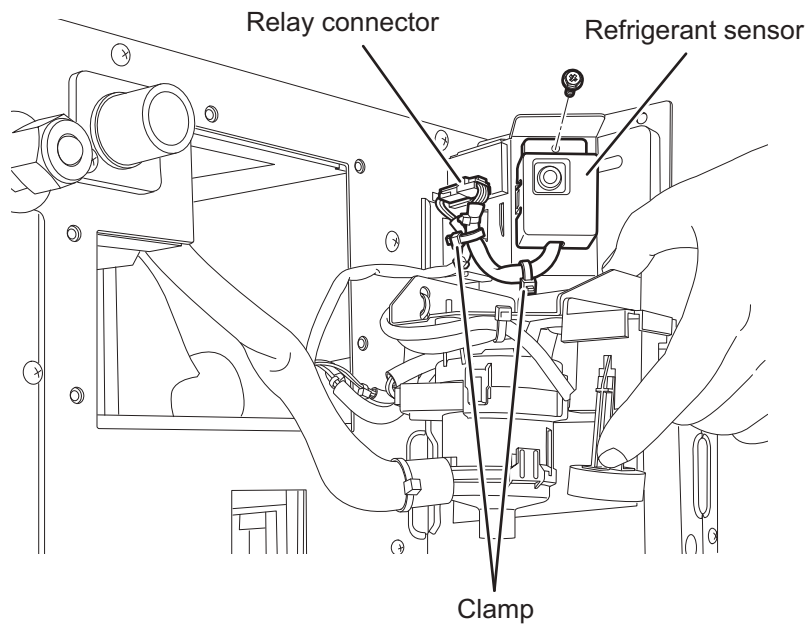

R6001350

6.3 Refrigerant Leak Detection (Monitoring)

Error Code	A0-19
Method of Error Detection	Refrigerant leak detection sensor detects a refrigerant leak.
Error Decision Conditions	When refrigerant concentrations exceeding the specified level are detected continuously during short-term sampling checks
Supposed Causes	<ul style="list-style-type: none"> ■ Refrigerant leak from system piping

Troubleshooting



Caution

- Be sure to turn off the power switch before connecting or disconnecting connectors, or parts may be damaged.
- Refrigerant may be leaking.
- Please check the refrigerant leaking in a well-ventilated environment to prevent accumulation.
- Be careful to avoid generating fire or sparks.
- While this error is being detected, the unit will operate the fan to disperse the refrigerant. Be sufficiently careful not to injure yourself.
- Even if no refrigerant is confirmed after detection, the leak detection function will continue for 5 minutes.

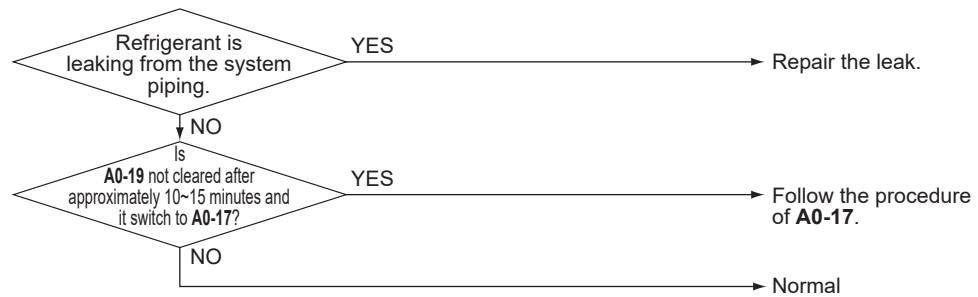

R6001342

6.4 Indoor Unit PCB Abnormality

Error Code

A1

Method of Error Detection

The system checks the data from EEPROM.

Error Decision Conditions

When the data from the EEPROM is not received correctly

EEPROM (Electrically Erasable Programmable Read Only Memory): A memory chip that holds its content without power. It can be erased, either within the computer or externally and usually requires more voltage for erasure than the common +5 volts used in logic circuits. It functions like non-volatile RAM, but writing to EEPROM is slower than writing to RAM.

Supposed Causes

- Defective indoor unit PCB
- External factor (noise etc.)

Troubleshooting



Caution

Be sure to turn off the power switch before connecting or disconnecting connectors, or parts may be damaged.

Turn off the power. Then, turn on the power to restart the system.

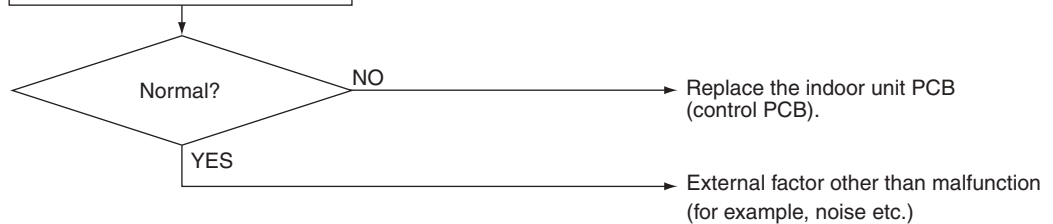

(R22247)

6.5 Drain Level Control System Abnormality

Error Code	A3
Method of Error Detection	The float switch detects error.
Error Decision Conditions	When the water level reaches its upper limit and when the float switch turns OFF
Supposed Causes	<ul style="list-style-type: none"> ■ Defective drain pump ■ Improper drain piping work ■ Clogged drain piping ■ Defective float switch ■ Defective indoor unit PCB ■ Defective short circuit connector X15A, X25A on indoor unit PCB

Troubleshooting

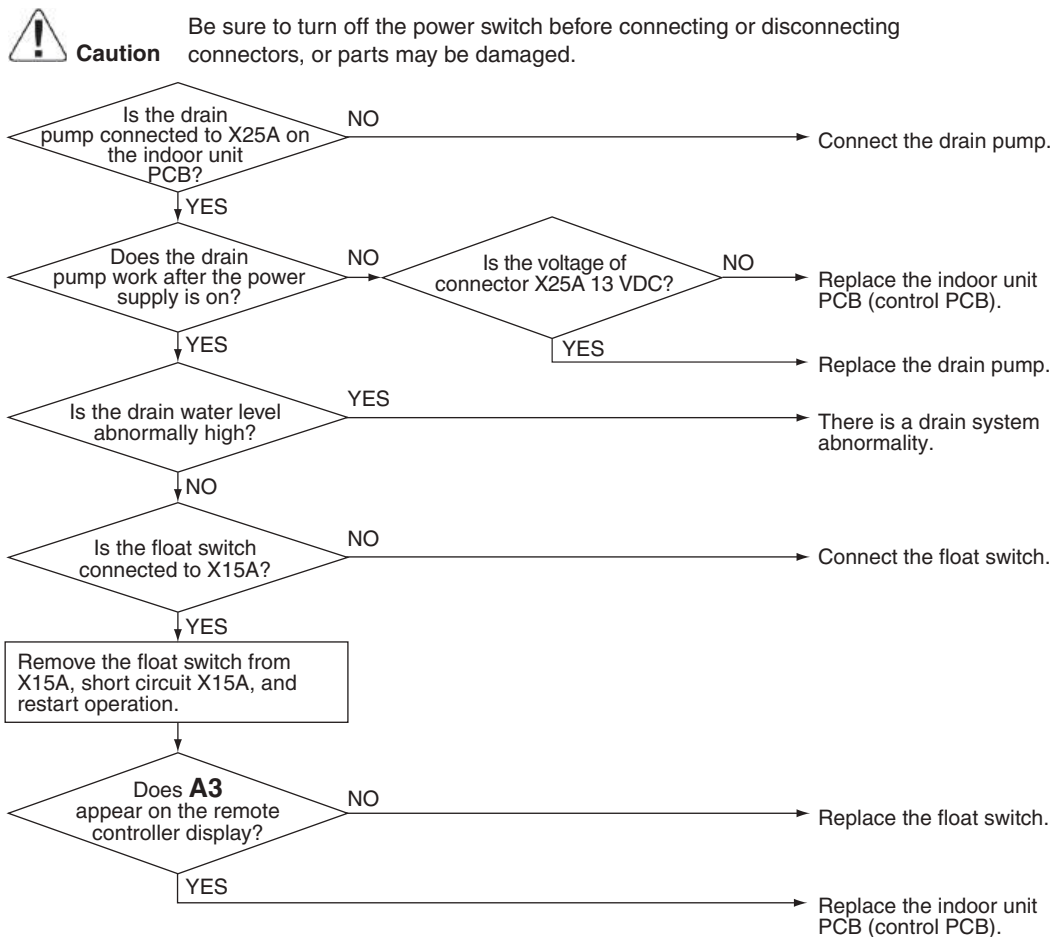

(R25079)

6.6 Indoor Fan Motor (DC Motor) or Related Abnormality

Error Code	A6
Method of Error Detection	<ul style="list-style-type: none"> ■ Detection from the current flow on the fan PCB ■ Detection from the rotation speed of the fan motor in operation
Error Decision Conditions	The rotation speed is less than a certain level for 6 seconds.
Supposed Causes	<ul style="list-style-type: none"> ■ Clogged foreign matter ■ Disconnection of fan motor connectors ■ Disconnection of the connector between the indoor unit PCB and the fan PCB ■ Defective fan PCB ■ Defective fan motor ■ No fuse continuity

Trouble Shooting

 **Caution** Be sure to turn off the power switch before connecting or disconnecting connectors, or parts may be damaged.

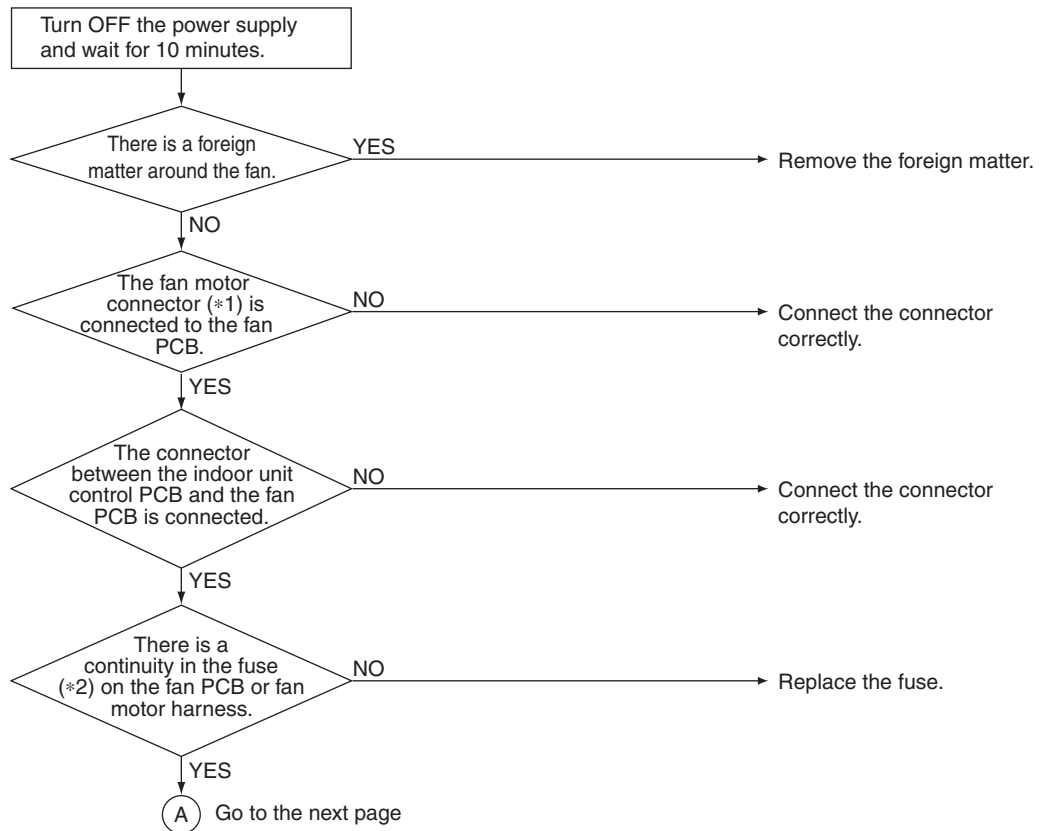

R6000547

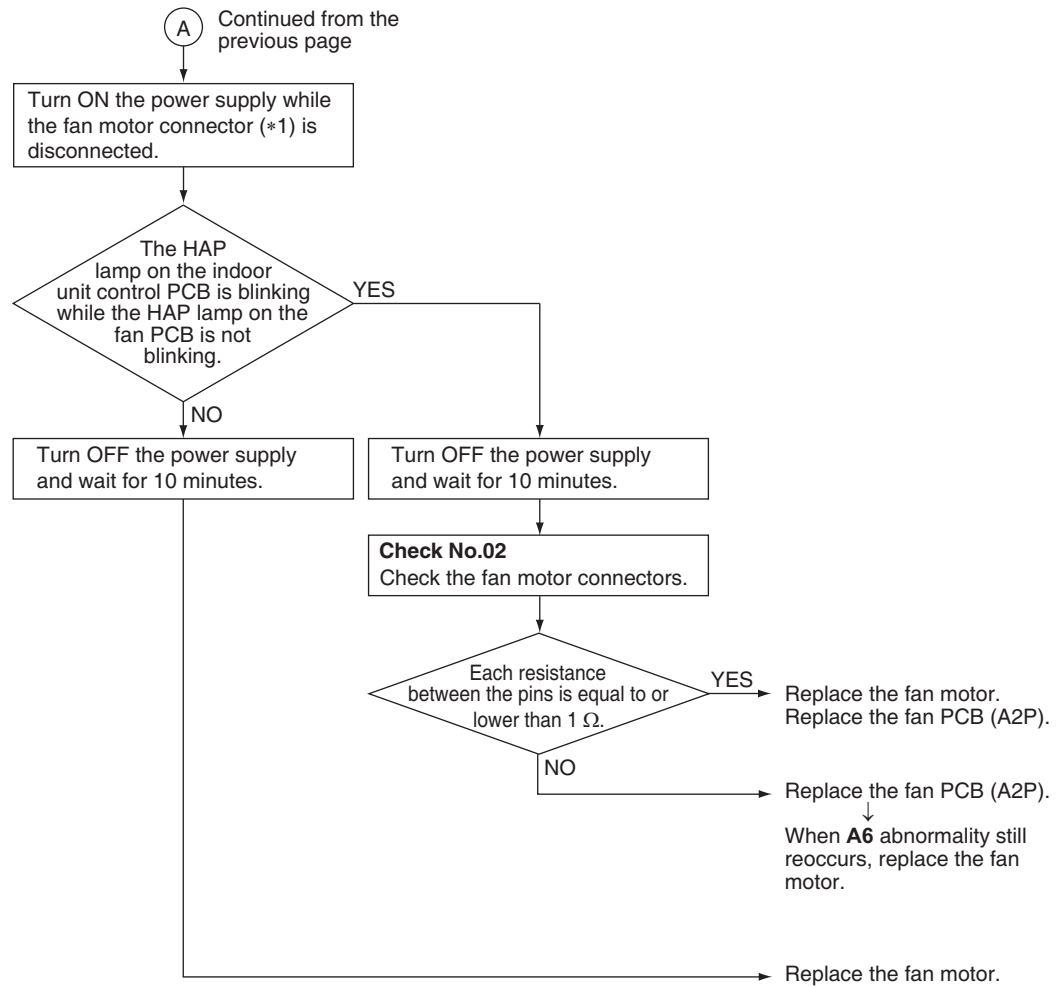

R6000961

i Note

Connector and indoor unit PCB

*1	*2
Fan motor connector	Fuse
X8A	F2U

📄 Reference

Check No.02 Refer to P.279

6.7 Indoor Fan PCB Abnormality

Error Code	A8
Method of Error Detection	Microcomputer checks the voltage state of the fan PCB.
Error Decision Conditions	Overvoltage or voltage drop is detected on the fan PCB.
Supposed Causes	<ul style="list-style-type: none"> ■ Defective fan PCB ■ External factor such as noise

Troubleshooting



Caution Be sure to turn off the power switch before connecting or disconnecting connectors, or parts may be damaged.

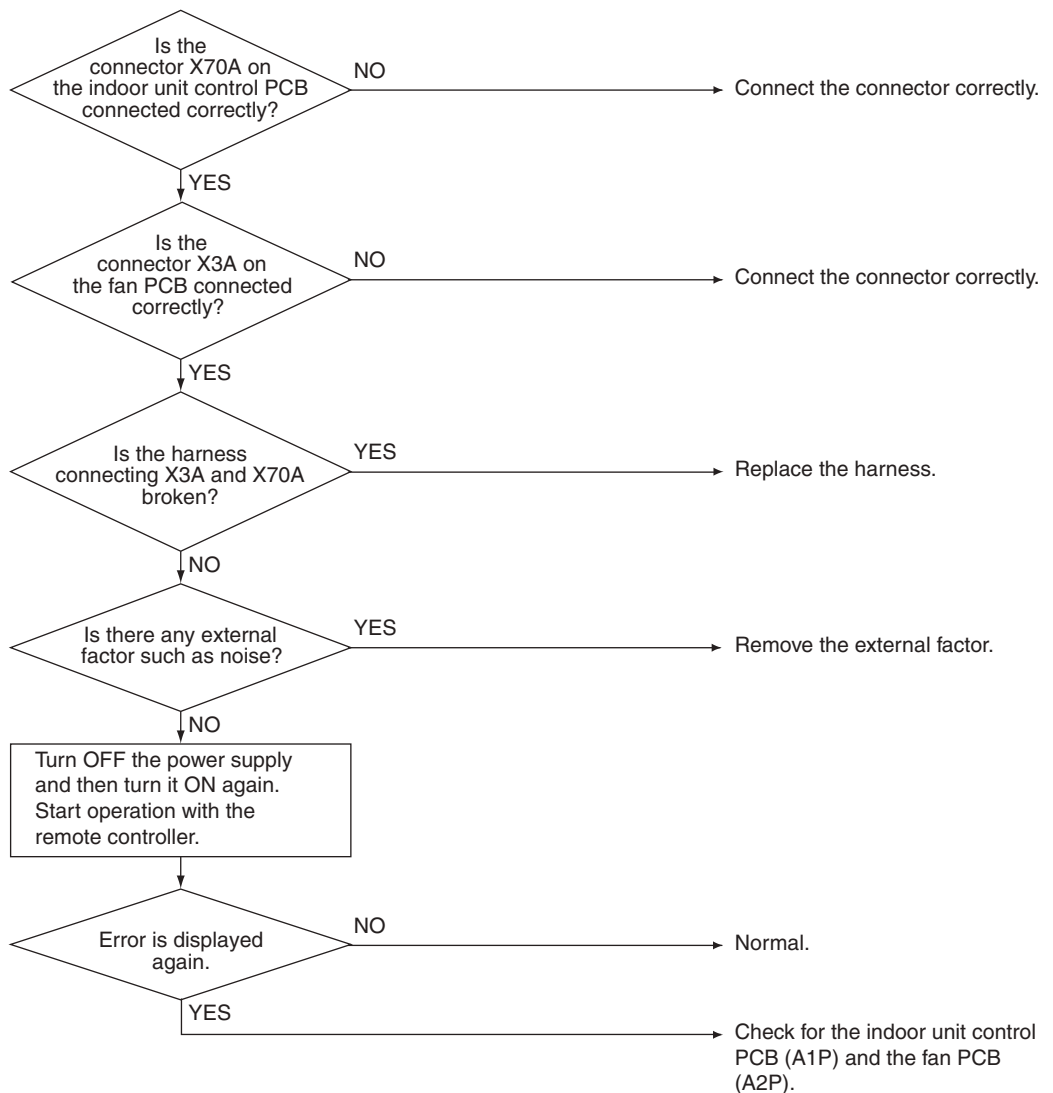

R6000549

6.8 Humidifier or Related Abnormality

Error Code	AF
Method of Error Detection	Water leakage from humidifier(s) is detected based on the float switch ON/OFF changeover while the system is not operating.
Error Decision Conditions	The float switch changes from ON to OFF while the system is OFF
Supposed Causes	<ul style="list-style-type: none"> ■ Defective float switch ■ Error in water drain system of humidifier(s) ■ Clogged electric expansion valve in humidifier(s) ■ Defective indoor unit PCB

Troubleshooting

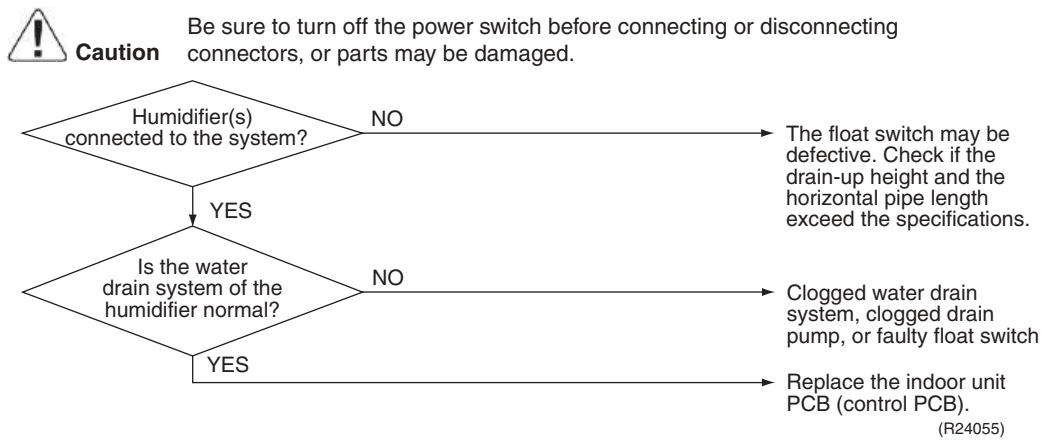

 **Note**

The system continues to operate with the thermostat OFF even while the error code is displayed.

6.9 Defective Capacity Setting

Error Code

AJ

Method of Error
Detection

Capacity is determined according to resistance of the capacity setting adaptor and the memory inside the IC memory on the indoor unit control PCB, and whether the value is normal or abnormal is determined.

Error Decision
Conditions

When the capacity code is not saved to the PCB, and the capacity setting adaptor is not connected. When a capacity that does not exist for that unit is set.

Supposed
Causes

- The capacity setting adaptor was not installed.
- Defective indoor unit control PCB

Troubleshooting



Caution

Be sure to turn off the power switch before connecting or disconnecting connectors, or parts may be damaged.

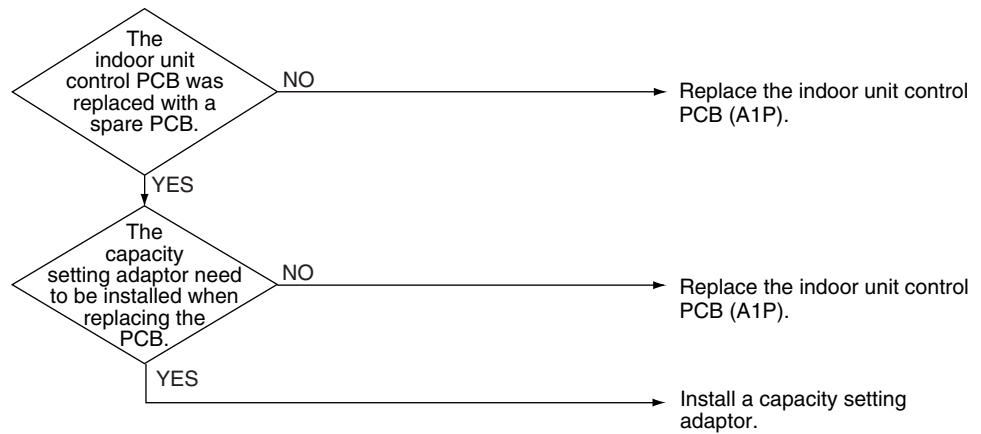

R6001344

6.10 Transmission Abnormality between Indoor Unit Control PCB and Fan PCB

Error Code	C1
Method of Error Detection	Transmission conditions between the indoor unit control PCB (A1P) and fan PCB (A3P) are checked via microcomputer.
Error Decision Conditions	When normal transmission is not carried out for a certain duration.
Supposed Causes	<ul style="list-style-type: none"> ■ Defective connection of the connector between indoor unit control PCB (A1P) and fan PCB (A2P) ■ Defective indoor unit control PCB (A1P) ■ Defective fan PCB (A2P) ■ External factor, such as instantaneous power failure

Troubleshooting

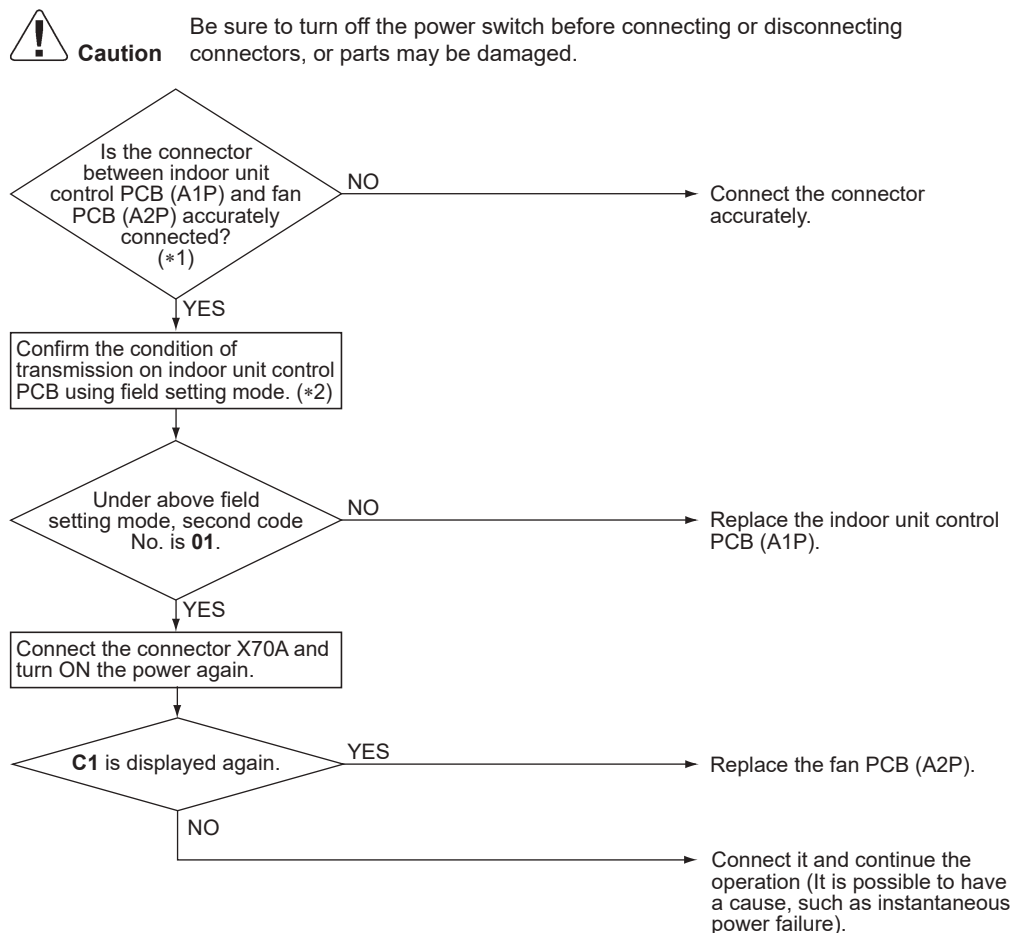

R6001345



Note(s)

- *1. Pull out and insert the connector once and check if it is absolutely connected.
- *2. Method to check transmission part of indoor unit control PCB.
 - (1) Turn OFF the power and remove the connector X70A of indoor unit control PCB (A1P).
 - (2) Short circuit X70A.
 - (3) After turning ON the power, check below numbers under field setting from remote controller. (Confirmation: Second code No. at the condition of first code No. 21 on mode No. 41)

Determination 01: Normal
 Other than 01: Transmission error on indoor unit control PCB

* After confirmation, turn OFF the power, take off the short circuit and connect X70A back to original condition.

6.11 Thermistor or Related Abnormality

Error Code	C4, C5, C9
Method of Error Detection	The temperatures detected by the thermistors determine thermistor errors.
Error Decision Conditions	The thermistor is disconnected or shorted while the unit is running.
Supposed Causes	<ul style="list-style-type: none"> ■ Disconnection of connector ■ Defective thermistor(s) ■ Breaking of wires ■ Defective indoor unit PCB
Troubleshooting	<p>If the cause of the problem is related to the thermistors, the thermistors should be checked prior to changing the indoor unit PCB.</p> <p>To check the thermistors, proceed as follows:</p> <ol style="list-style-type: none"> 1. Disconnect the thermistor from the indoor unit PCB. 2. Read the temperature and the resistance value. 3. Check if the measured values correspond with the values in the table of thermistor resistance check.

 **Caution** Be sure to turn off the power switch before connecting or disconnecting connectors, or parts may be damaged.

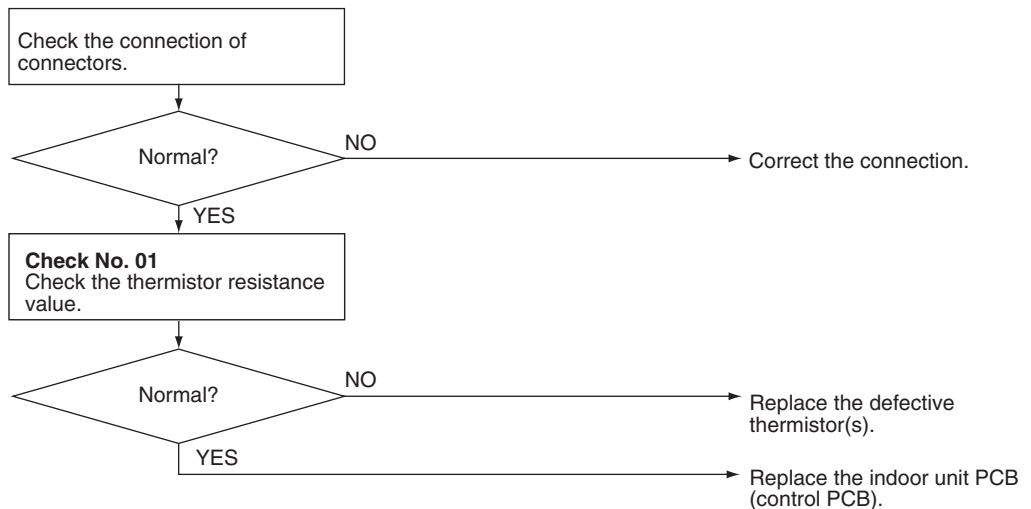

(R24056)

- C4:** Indoor heat exchanger thermistor 1 (liquid pipe) (R2T)
- C5:** Indoor heat exchanger thermistor 2 (R3T)
- C9:** Room temperature thermistor (R1T)



Reference

Check No.01 Refer to P.278

6.12 Refrigerant Leak Detection Sensor Failure

Error Code**CH-11**

Method of Error Detection

Error is issued when control PCB (A1P) receives fault status from leak detection sensor during operation.

Error Decision Conditions

When leak detection sensor sends fault status information to control PCB (A1P) for a certain set timeframe.

Supposed Causes

- Broken leak detection sensor
 - Degraded leak detection sensor
-

Troubleshooting

- Replace the leak detection sensor.
- Change the field setting 15 (25)-14 to **02** and turn the power back on.

6.13 Refrigerant Leak Detection Sensor Disconnection

Error Code	CH-14
Method of Error Detection	Error is issued when leak detection sensor is not connected to A1P control PCB when powered up.
Error Decision Conditions	When A1P control PCB does not have a connection with leak detection sensor at startup.
Supposed Causes	<ul style="list-style-type: none"> ■ Disconnected leak detection sensor ■ Broken wires in, short circuit of, or disconnection of connector of leak detection sensor ■ Incorrect wiring ■ Defective A1P control PCB

Troubleshooting

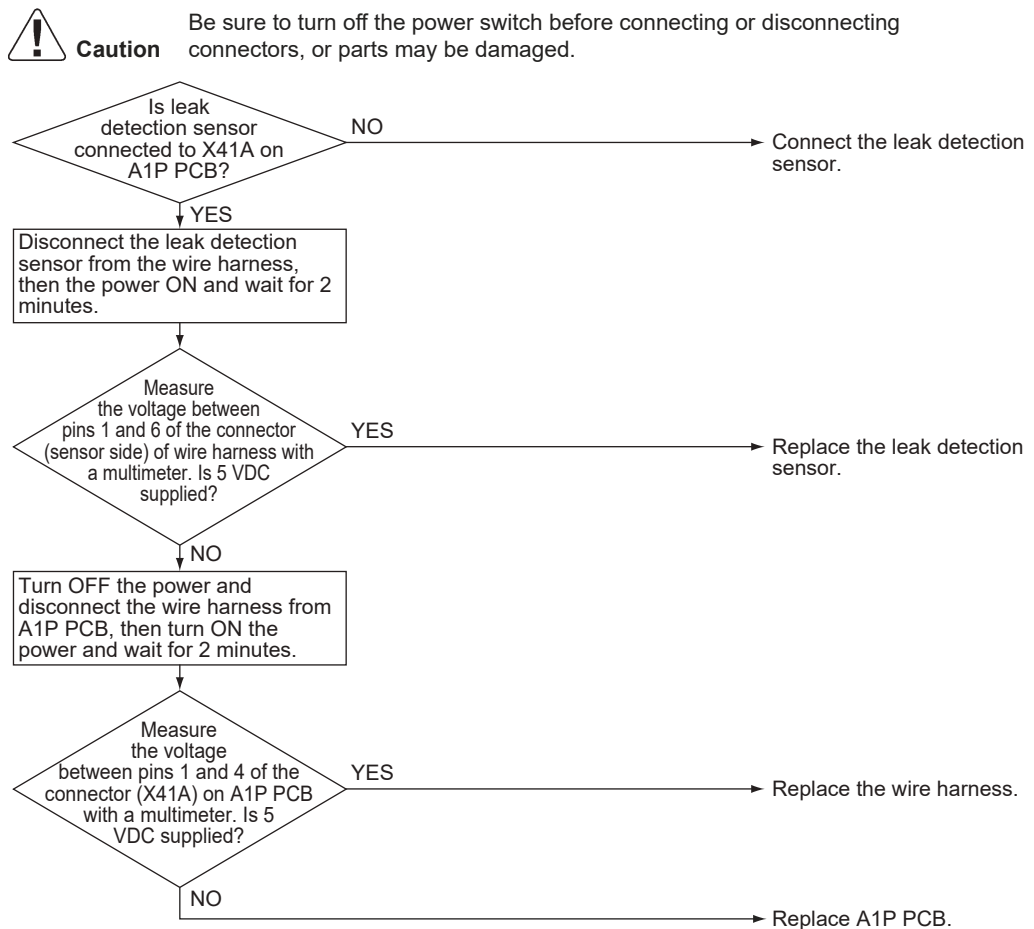

R6001346

6.14 Remote Controller Thermistor Abnormality

Error Code	CJ
Method of Error Detection	Even if remote controller thermistor is faulty, system is possible to operate by system thermistor. Malfunction detection is carried out by the temperature detected by the remote controller thermistor.
Error Decision Conditions	The remote controller thermistor is disconnected or shorted while the unit is running.
Supposed Causes	<ul style="list-style-type: none"> ■ Defective room temperature thermistor in the wired remote controller ■ Defective wired remote controller PCB ■ External factor such as noise

Troubleshooting

Caution

Be sure to turn off the power switch before connecting or disconnecting connectors, or parts may be damaged.

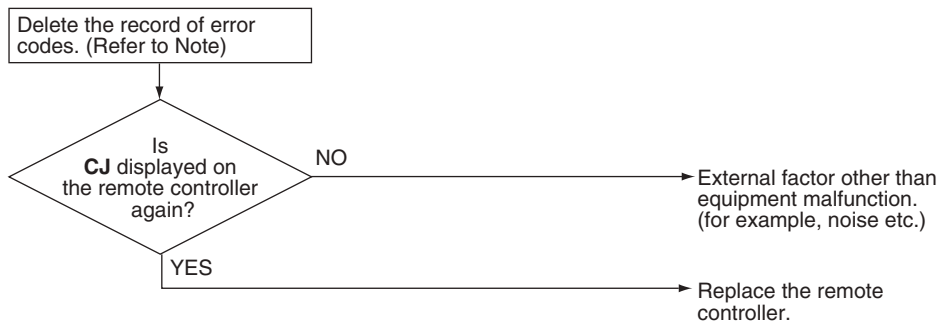

(R23951)

Note

To delete the record of error codes, press **ON/OFF** button on the remote controller for 4 seconds or more while the error code is displayed in the inspection mode.

6.15 Signal Transmission Error (Between Indoor Unit and Outdoor Unit)

Error Code	U4
Method of Error Detection	The signal transmission data received from the outdoor unit is checked whether it is normal.
Error Decision Conditions	The data sent from the outdoor unit cannot be received normally, or the content of the data is abnormal.
Supposed Causes	<ul style="list-style-type: none">■ Power supply voltage not as specified■ Reduction of power supply voltage■ Wiring error■ Breaking of the connection wires between the indoor and outdoor units (wire No. 3)■ Defective outdoor unit PCB■ Short circuit inside the fan motor winding■ Defective indoor unit PCB■ Disturbed power supply waveform

Troubleshooting



Caution Be sure to turn off the power switch before connecting or disconnecting connectors, or parts may be damaged.

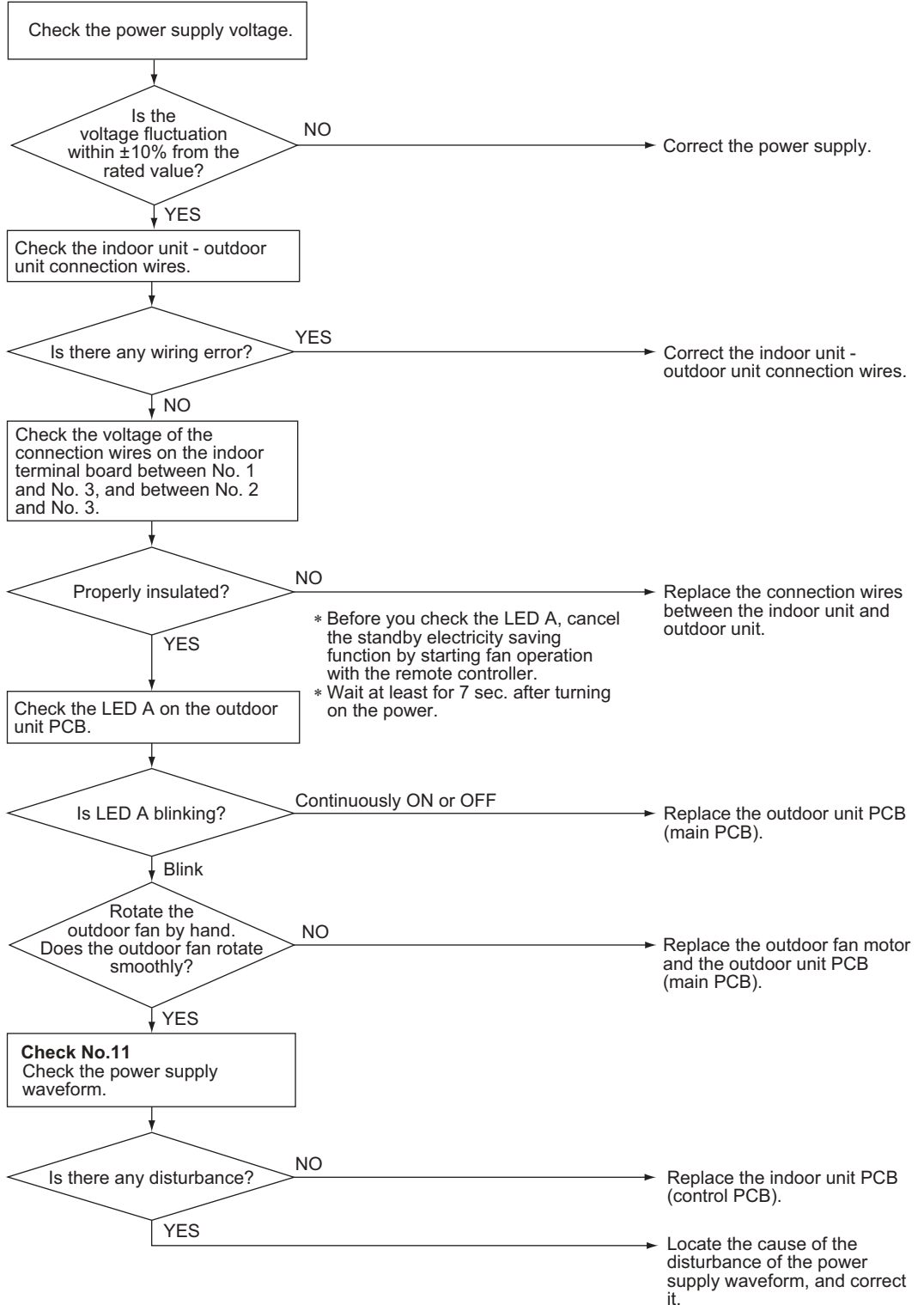

(R21189)



Reference

Check No.11 Refer to P.281

6.16 Signal Transmission Error (Between Indoor Unit and Remote Controller)

Error Code

U5

Method of Error Detection

In case of controlling 1 indoor unit with 2 remote controllers, check the system using microcomputer if signal transmission between indoor unit and remote controller (main and sub) is normal.

Error Decision Conditions

Normal transmission does not continue for specified period.

Supposed Causes

- Connection of 2 main remote controllers (when using 2 remote controllers)
- Defective indoor unit PCB
- Defective remote controller
- Transmission error caused by noise

Troubleshooting

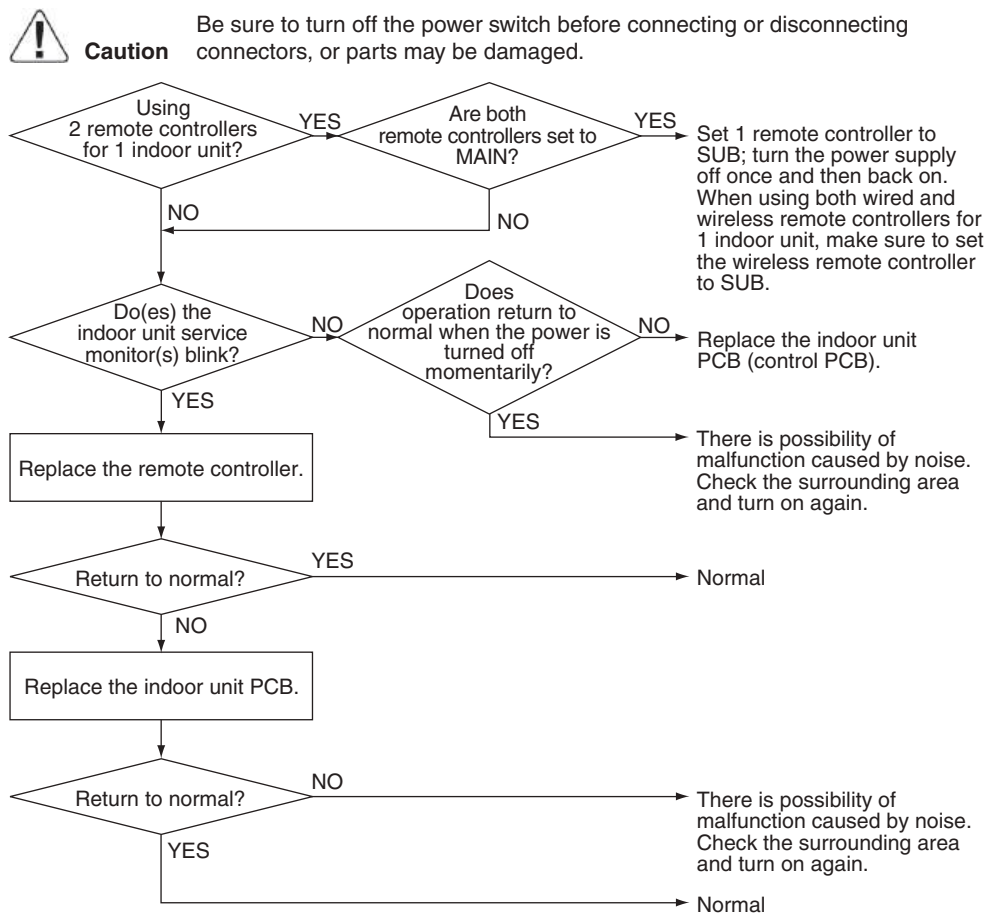

(R24590)



Note

For the way to change MAIN/SUB setting of remote controllers, refer to pages 326.

6.17 Signal Transmission Error (Between MAIN/SUB Remote Controllers)

Error Code	U8
Method of Error Detection	In case of controlling 1 indoor unit with 2 remote controllers, check the system using microcomputer if signal transmission between MAIN remote controller and SUB remote controller is normal.
Error Decision Conditions	Normal transmission does not continue for specified period.
Supposed Causes	<ul style="list-style-type: none"> ■ Remote controller is set to SUB when using 1 remote controller ■ Connection of 2 SUB remote controllers (when using 2 remote controllers) ■ Defective remote controller PCB

Troubleshooting

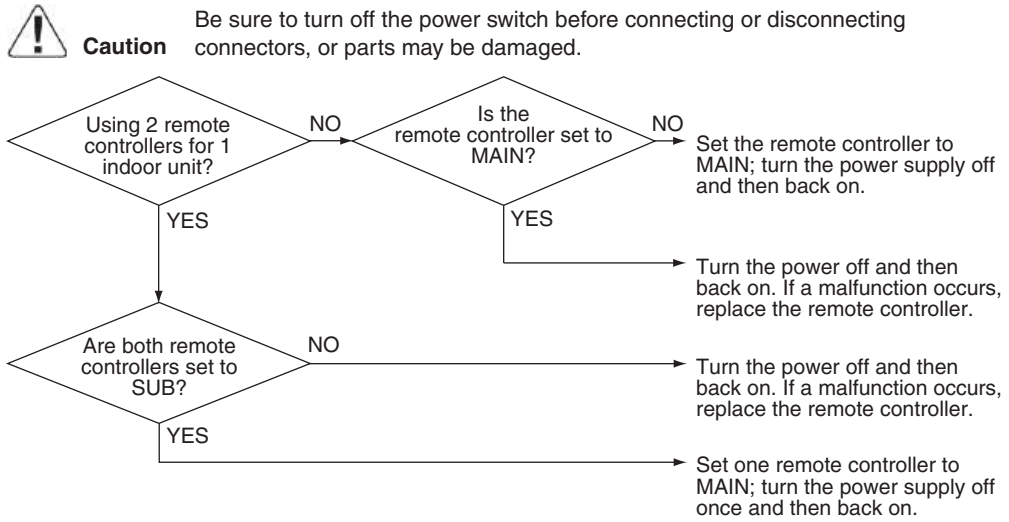

(R24058)

 **Note**

For the way to change MAIN/SUB setting of remote controllers, refer to pages 326.

6.18 Unspecified Voltage (Between Indoor Unit and Outdoor Unit)

Error Code

UA

Error Decision Conditions

Improper combination of indoor and outdoor units

Supposed Causes

- Defective indoor unit PCB
- Indoor-outdoor unit transmission wiring error
- Defective optional unit(s) wirings
- Improper power supply wiring of indoor unit
- Improper wiring of connecting wires between indoor/outdoor units

Troubleshooting



Caution Be sure to turn off the power switch before connecting or disconnecting connectors, or parts may be damaged.

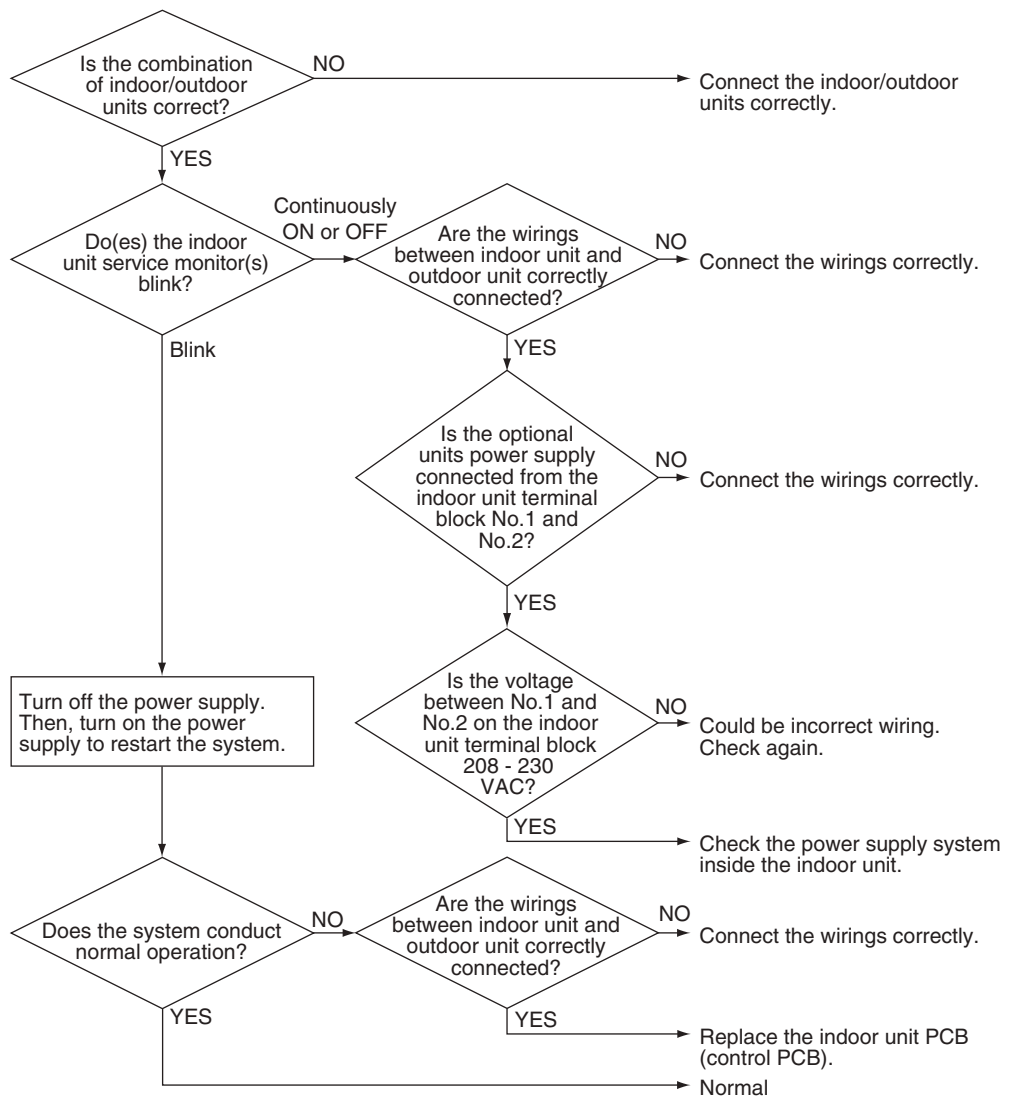

(R24591)

6.19 Address Duplication of Centralized Controller

Error Code	UC
Method of Error Detection	The principal indoor unit detects the same address as that of its own on any other indoor unit.
Error Decision Conditions	The error decision is made as soon as the abnormality aforementioned is detected.
Supposed Causes	<ul style="list-style-type: none"> ■ Address duplication of centralized controller ■ Defective indoor unit PCB
Troubleshooting	

**Caution**

Be sure to turn off the power switch before connecting or disconnecting connectors, or parts may be damaged.

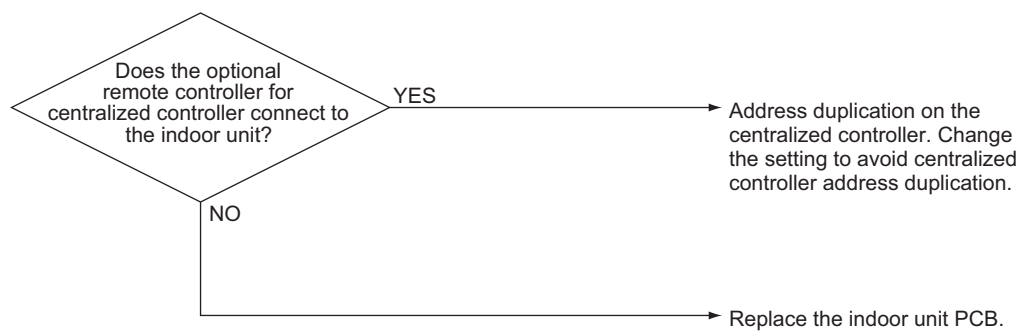

R6001343

7. Troubleshooting for Floor Standing Type

7.1 Refrigerant Leak Detection

Error Code	A0
Method of Error Detection	Refrigerant leak detection sensor detects a refrigerant leak.
Error Decision Conditions	According to the refrigerant leakage sensor, gas such as refrigerant at or above a given concentration will be detected for 4 continuous seconds. However, detection will not operate for 180 seconds required for the sensor to stabilize after turning the power on.
Supposed Causes	<ul style="list-style-type: none"> ■ Gas detection due to refrigerant leakage ■ Non-refrigerant gas detection ■ Detection of outdoor gas leakage ingress indoors ■ Gas detection due to refrigerant leakage from different indoor units in same room

Troubleshooting

Caution Be sure to turn off the power switch before connecting or disconnecting connectors, or parts may be damaged.

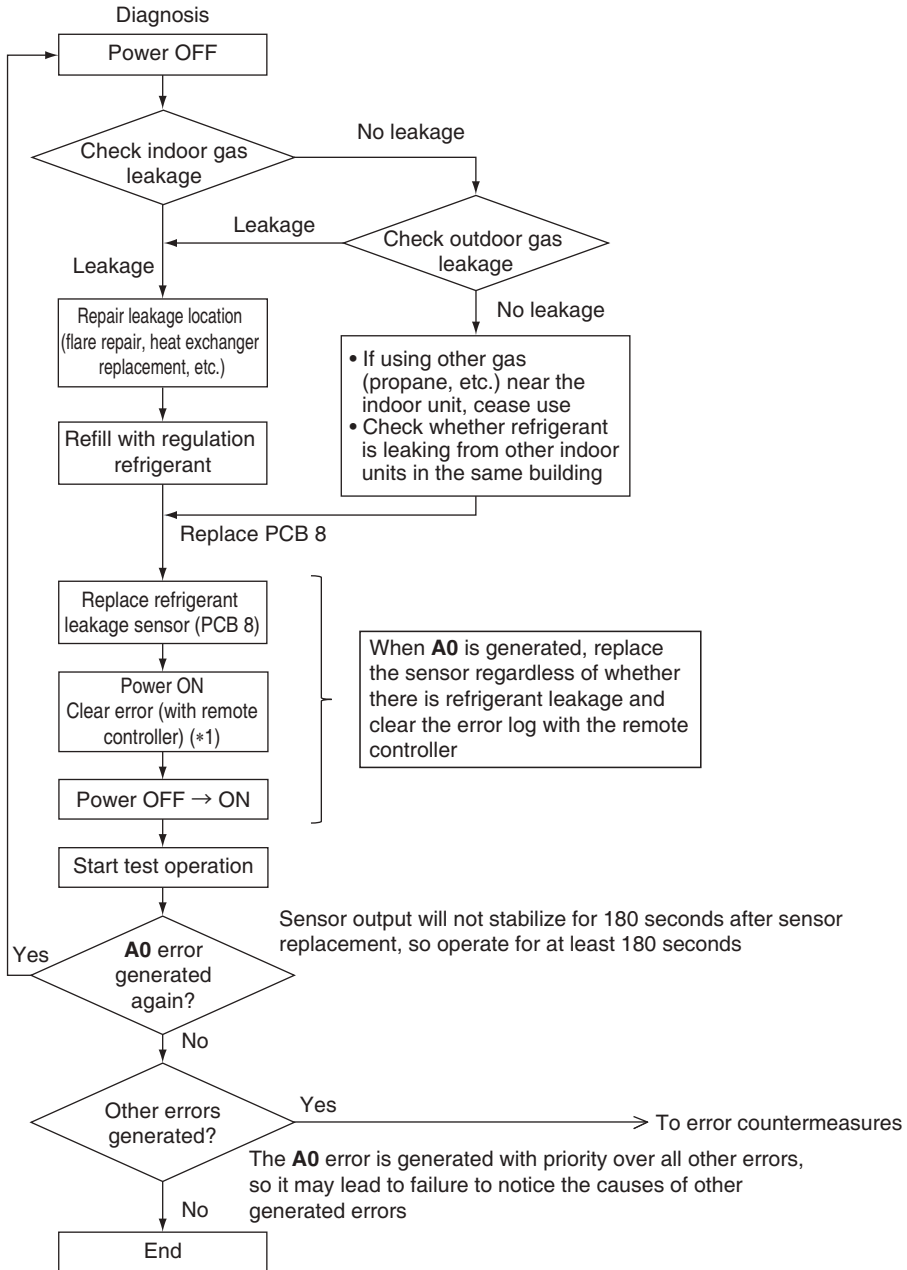

- When an **A0** error is generated, provide sufficient ventilation.
- Regardless of whether there is refrigerant leakage, when **A0** is generated, replace the refrigerant leakage sensor.
- After replacing the sensor, clear the remote control error log and reset the power again; then conduct test operation.

R6001414

Note

*1. Clearing the error log
In service mode, go to the error code display screen and hold down the remote controller On/Off button for 5 seconds.

Replacing the refrigerant sensor

1. Remove the front grille.

1-1 Remove the front panel.

- Push in the protrusions on the unit (the left and right sides).

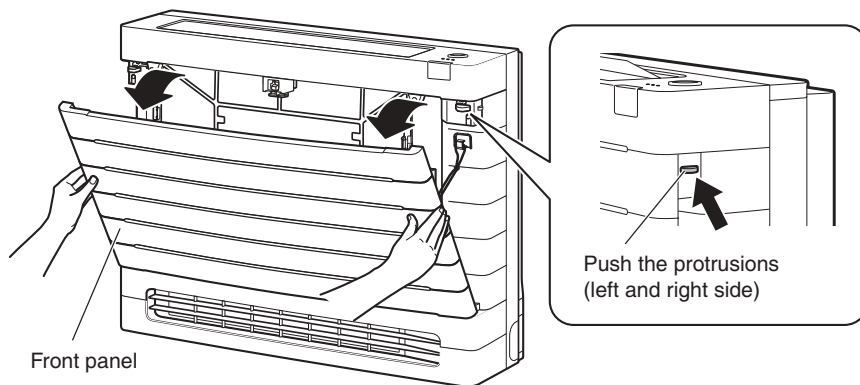

R6001419

- Unhook the string and tilt the front panel toward you to remove it.

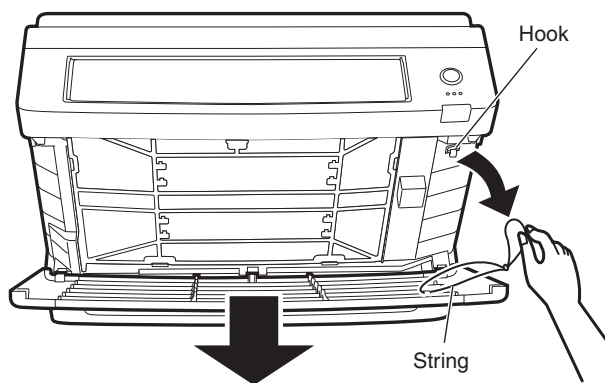

R6001420

1-2 Remove the 4 screws and open the flap.

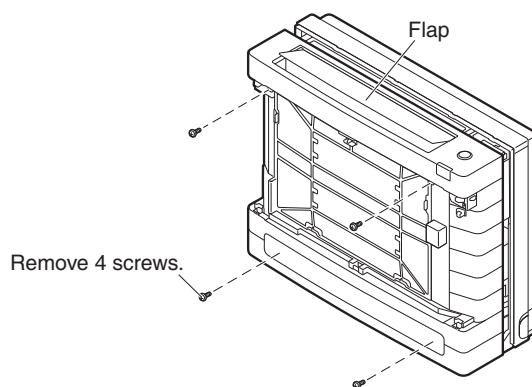

R6001421

1-3 Hold the upper part of the front grille, pull it slightly toward you to release the front grille catches, and pull it out diagonally upward so as to avoid the flap.

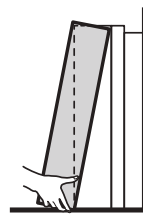
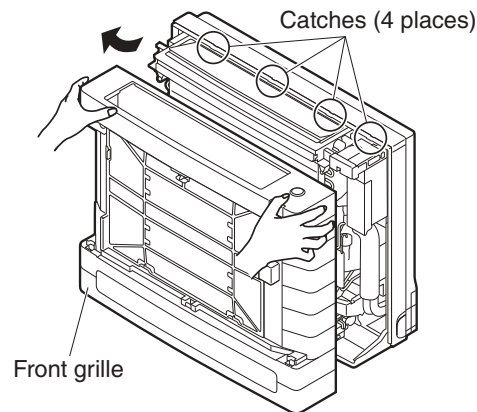

Wrong

Do not attempt to remove the front grille from the bottom. The grille may be damaged.

R6001422

2. Remove the refrigerant sensor PCB.
2-1 Remove 1 screw and then remove the cover assembly (gas sensor).

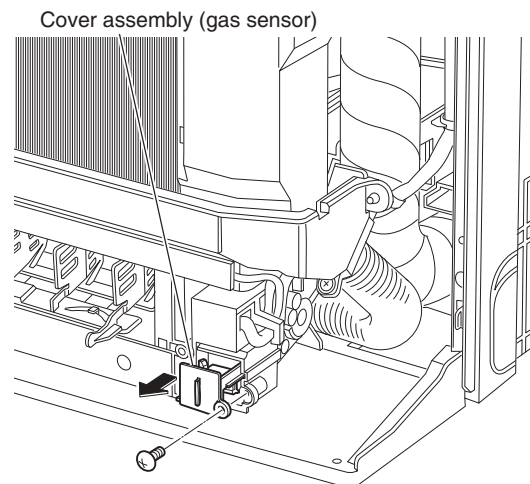

R6001415

2-2 Flip over the cover assembly (gas sensor) and remove 1 snap band and the connector.
 ★ When pulling out the cover assembly or replacing the sensor, be careful not to pull the harness too hard. Also, be careful not to entangle the harness when mounting. (cause of disconnection)

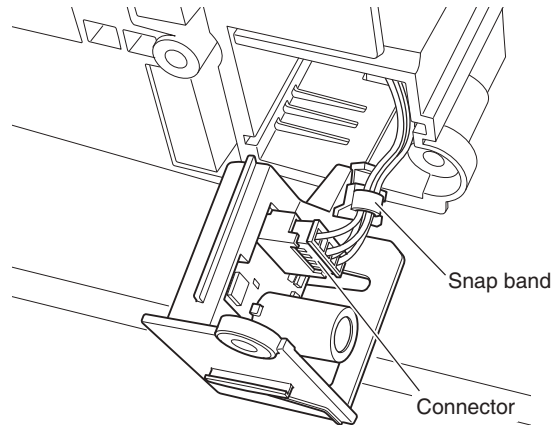

R6001416

2-3 Remove 1 hook and then remove PCB 8 (gas sensor).
 ★ After replacing PCB 8 (gas sensor), be sure to clear the error code.

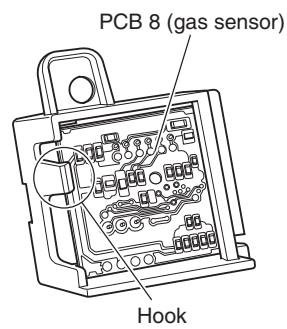

R6001417

7.2 Indoor Unit PCB Abnormality

Error Code	A1
Method of Error Detection	The system checks if the circuit works properly within the microcomputer of the indoor unit.
Error Decision Conditions	The system cannot set the internal settings.
Supposed Causes	<ul style="list-style-type: none"> ■ Wrong models interconnected ■ Defective indoor unit PCB ■ Disconnection of connector ■ Reduction of power supply voltage

Troubleshooting

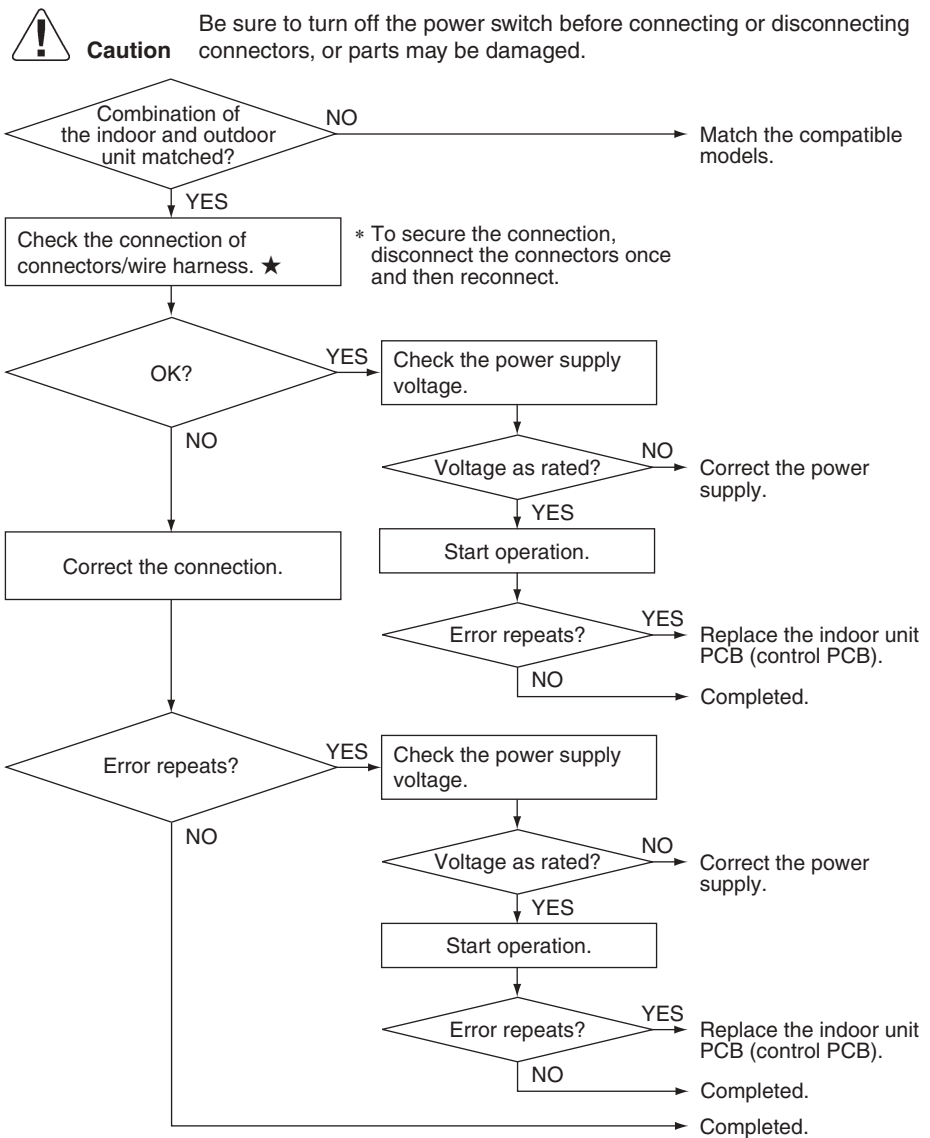

R6000615

**Note****★ Wire Harness (Connector)**

Terminal strip ~ Power supply PCB (X101A (S101))
Power supply PCB (X102A (S102), X103A (S103)) ~ Control PCB (X300A (S300A), X301A (S301B))

7.3 Freeze-up Protection Control/Heating Peak-cut Control

Error Code	A5
Method of Error Detection	<ul style="list-style-type: none"> ■ Freeze-up protection control During cooling operation, the freeze-up protection control (operation halt) is activated according to the temperature detected by the indoor heat exchanger thermistor. ■ Heating peak-cut control During heating operation, the temperature detected by the indoor heat exchanger thermistor is used for the heating peak-cut control (operation halt, outdoor fan stop, etc.)
Error Decision Conditions	<ul style="list-style-type: none"> ■ Freeze-up protection control During cooling operation, the indoor heat exchanger temperature is below 0°C (32°F). ■ Heating peak-cut control During heating operation, the indoor heat exchanger temperature is above 59 ~ 60°C (138.2 ~ 140°F).
Supposed Causes	<ul style="list-style-type: none"> ■ Short-circuited air ■ Clogged air filter of the indoor unit ■ Dust accumulation on the indoor heat exchanger ■ Defective indoor heat exchanger thermistor ■ Defective indoor unit PCB

Troubleshooting

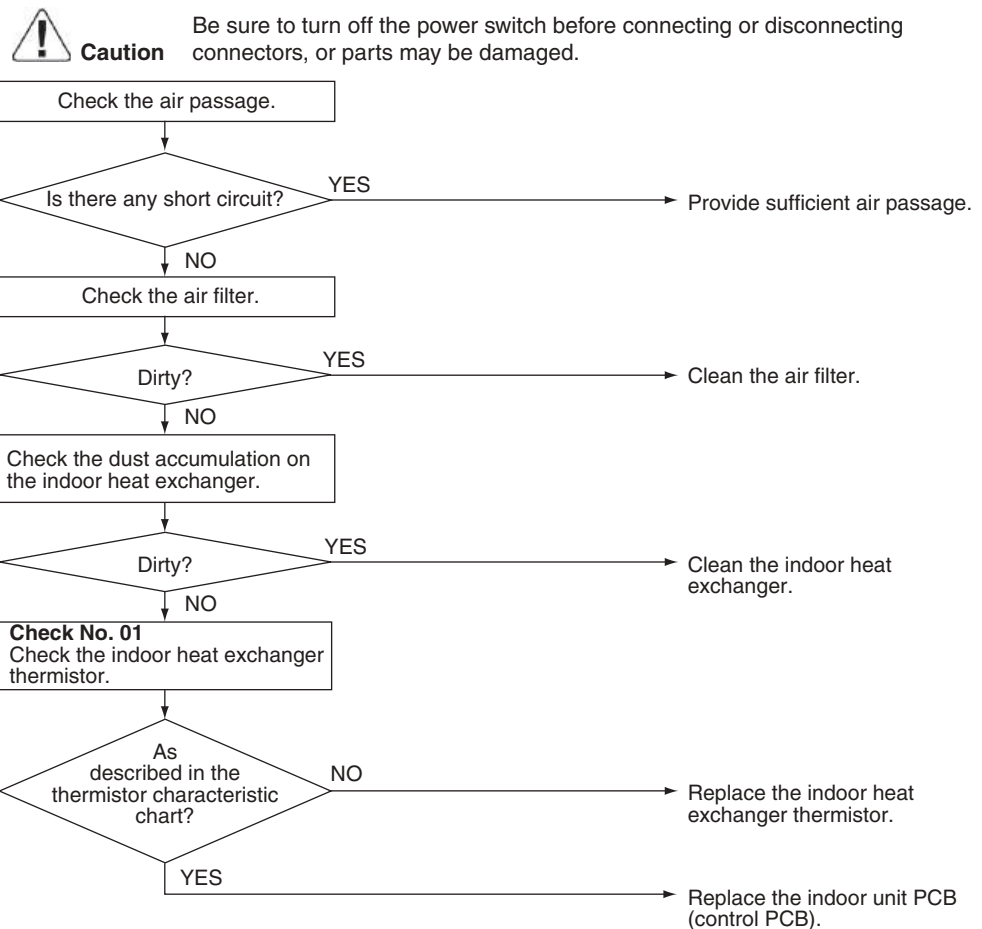

(R21064)



Reference

Check No.01 Refer to P.278

7.4 Indoor Fan Motor (DC Motor) or Related Abnormality

Error Code	A6
Method of Error Detection	The rotation speed detected by the Hall IC during fan motor operation is used to determine abnormal fan motor operation.
Error Decision Conditions	The detected rotation speed does not reach the demanded rotation speed of the target tap, and is less than 50% of the maximum fan motor rotation speed.
Supposed Causes	<ul style="list-style-type: none"> ■ Remarkable decrease in power supply voltage ■ Layer short inside the fan motor winding ■ Breaking of wire inside the fan motor ■ Breaking of the fan motor lead wires ■ Defective capacitor of the fan motor ■ Defective indoor unit PCB

Troubleshooting

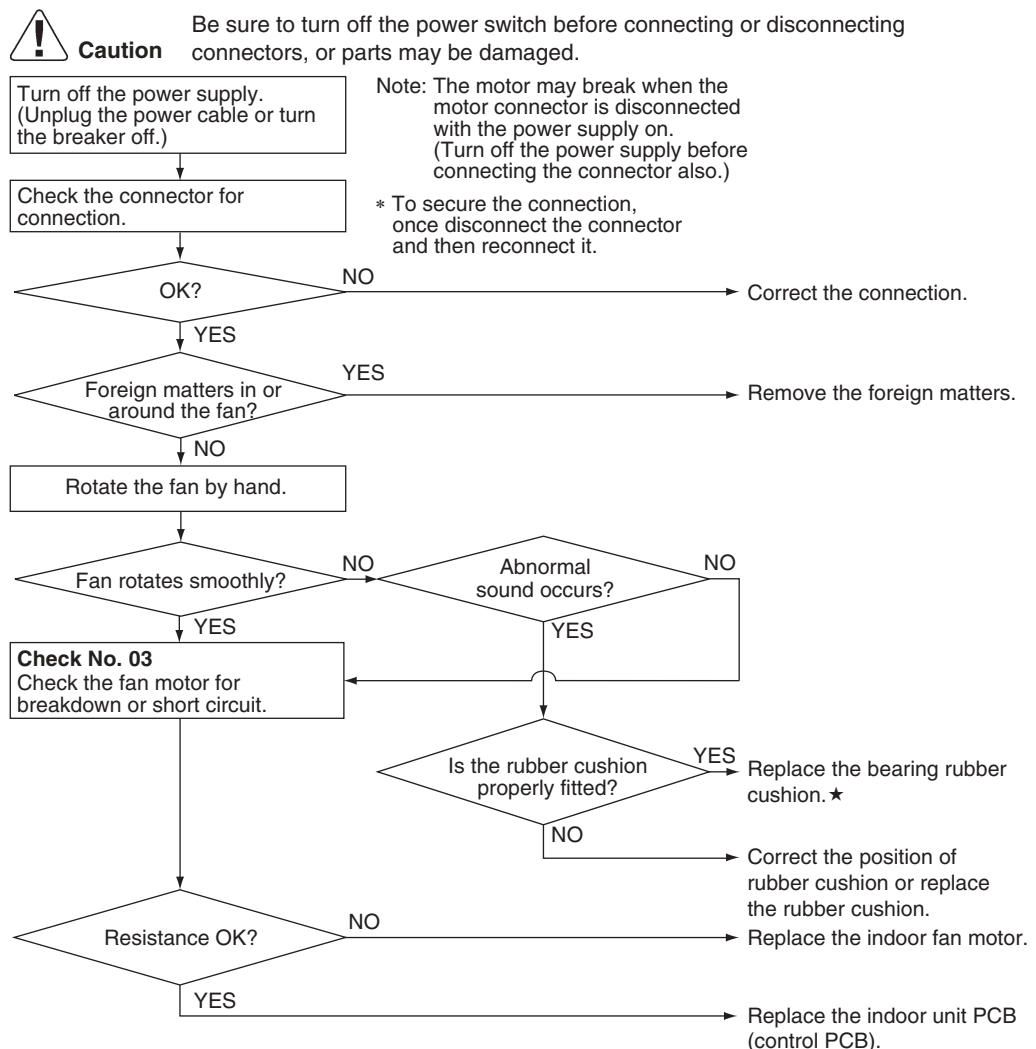

R6000794



Reference

Check No.03 Refer to P.279

7.5 Thermistor or Related Abnormality (Indoor Unit)

Error Code	C4, C9 (C922)
Method of Error Detection	The temperatures detected by the thermistors determine thermistor errors.
Error Decision Conditions	The voltage between the both ends of the thermistor is either 4.96 V or more, or 0.04 V or less with the power on.
Supposed Causes	<ul style="list-style-type: none"> ■ Disconnection of connector ■ Defective thermistor(s) ■ Defective indoor unit PCB

Troubleshooting

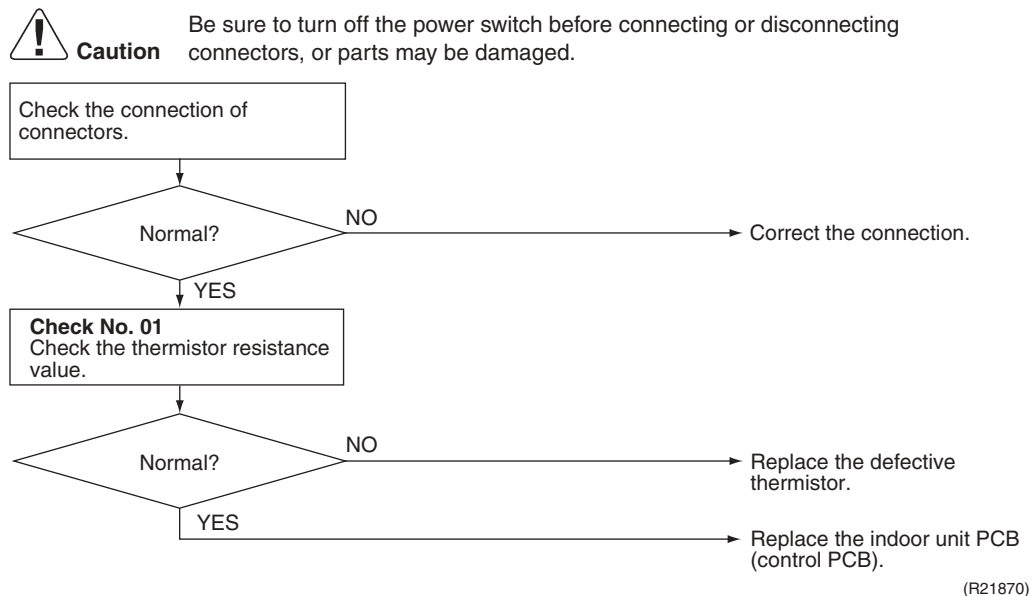

C4: Indoor heat exchanger thermistor

C9 (C922): Room temperature thermistor (Left side of body)

Remote controller (Error code display):

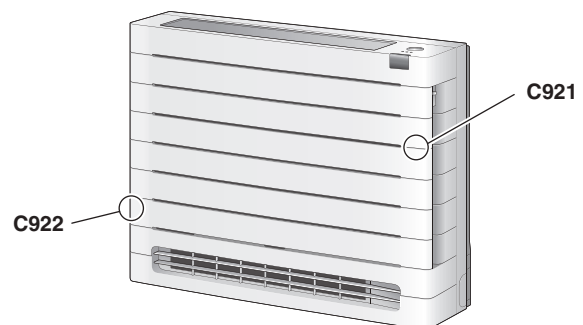
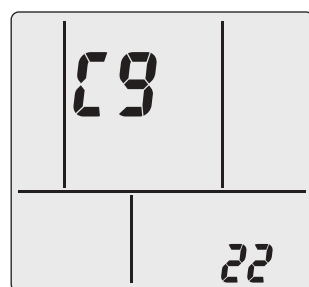

R6001140

Note

In case of simultaneous abnormality of **C921** and **C922**.

Diagnose by the sound, long beep will occur only **C9** and **C921**.

Therefore, must change the defective thermistor of **C921** (right side) first and then please check error code again.

Reference

Check No.01 Refer to P.278

7.6 Room Temperature Sensor Abnormality/Humidity Sensor Abnormality

Error Code

CC, C9 (C921)

Method of Error Detection

Sensor abnormality is detected by input value.

Error Decision Conditions

The input from the humidity sensor is 4.96 V and more or 0.04 V and less.

Supposed Causes

- Disconnection of connector
- Defective humidity sensor
- Defective indoor unit PCB

Troubleshooting

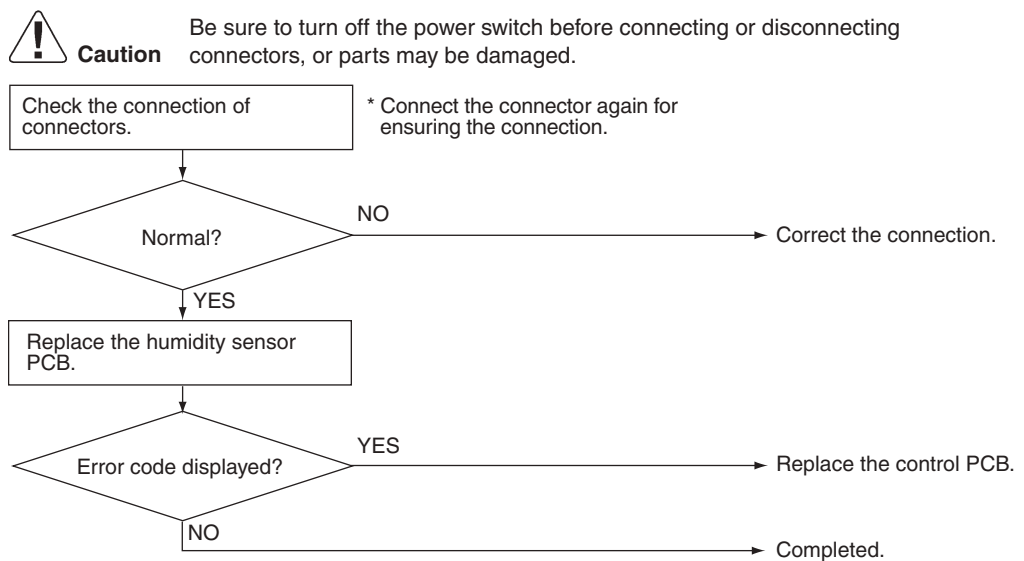

R6000515

CC: Humidity sensor

C9 (C921): Room temperature thermistor (Right side of body)

Remote controller (Error code display):

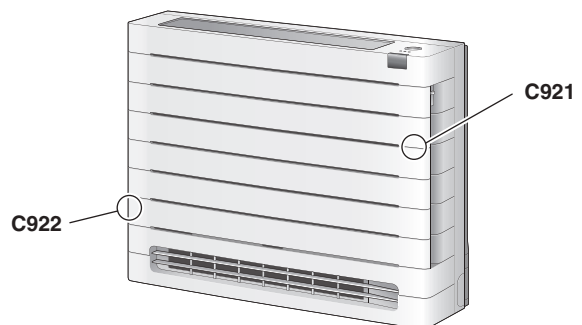
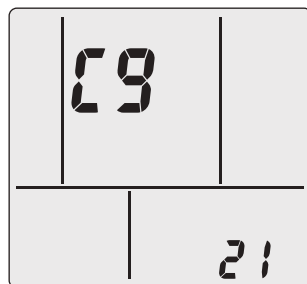

R6001141



Note

In case of abnormality of **C921** and **C922**.

Diagnose by the sound, long beep will occur only **C9** and **C921**.

Therefore, must change the defective thermistor of **C921** (right side) first and then please check error code again.

7.7 Refrigerant Leak Detection Sensor Failure or Disconnection

Error Code	CH
Method of Error Detection	Refrigerant leak detection sensor detects a refrigerant leak.
Error Decision Conditions	Refrigerant leakage sensor fault judgment status continues for 30 continuous seconds.
Supposed Causes	<ul style="list-style-type: none"> ■ Refrigerant leakage sensor fault ■ Refrigerant leakage sensor disconnection ■ Refrigerant leakage sensor connection defect ■ Refrigerant leakage sensor aging deterioration ■ Indoor unit PCB fault

Troubleshooting

 **Caution** Be sure to turn off the power switch before connecting or disconnecting connectors, or parts may be damaged.

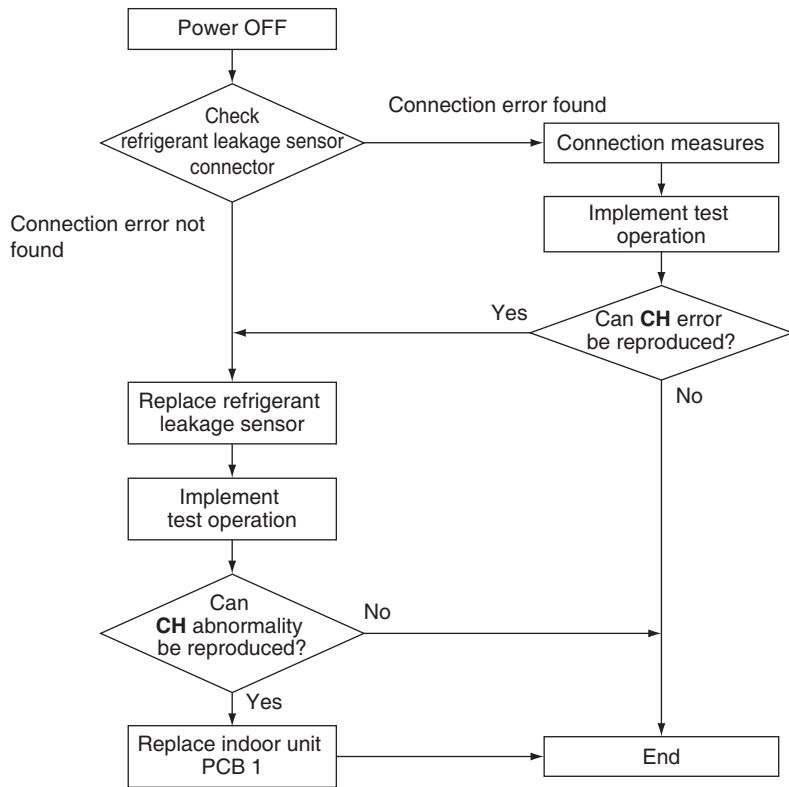

R6001418

7.8 Low-voltage Detection or Over-voltage Detection

Error Code	U2
Method of Error Detection	<ul style="list-style-type: none"> ■ Indoor Unit The zero-cross detection of the power supply is evaluated by the indoor unit PCB. ■ Outdoor Unit Low-voltage detection: An abnormal voltage drop is detected by the DC voltage detection circuit. Over-voltage detection: An abnormal voltage rise is detected by the over-voltage detection circuit.
Error Decision Conditions	<ul style="list-style-type: none"> ■ Indoor Unit There is no zero-cross detection in approximately 10 seconds. ■ Outdoor Unit Low-voltage detection: <ul style="list-style-type: none"> ● The voltage detected by the DC voltage detection circuit is below 150 ~ 200 V (depending on the model). ● The compressor stops if the error occurs, and restarts automatically after 3-minute standby. Over-voltage detection: <ul style="list-style-type: none"> ● An over-voltage signal is fed from the over-voltage detection circuit to the microcomputer. ● The compressor stops if the error occurs, and restarts automatically after 3-minute standby.
Supposed Causes	<ul style="list-style-type: none"> ■ Power supply voltage out of specification ■ Defective DC voltage detection circuit ■ Defective over-voltage detection circuit ■ Defective PAM control part ■ Disconnection of compressor harness ■ Short circuit inside the fan motor winding ■ Noise ■ Momentary drop of voltage ■ Momentary power failure ■ Defective outdoor unit PCB ■ Defective indoor unit PCB

Troubleshooting

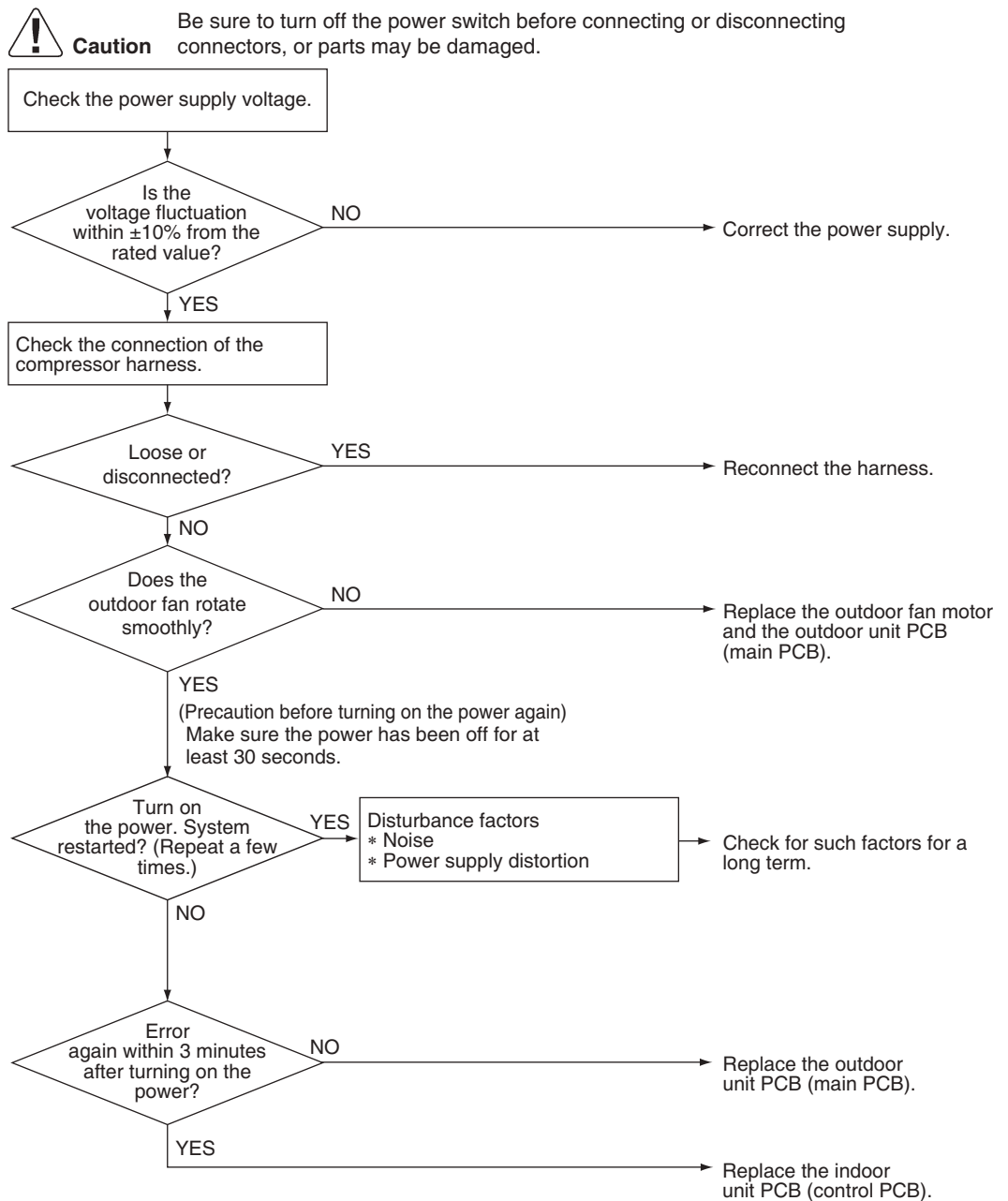

(R22370)

7.9 Signal Transmission Error (Between Indoor Unit and Outdoor Unit)

Error Code	U4
Method of Error Detection	The signal transmission data received from the outdoor unit is checked whether it is normal.
Error Decision Conditions	The data sent from the outdoor unit cannot be received normally, or the content of the data is abnormal.
Supposed Causes	<ul style="list-style-type: none">■ Power supply voltage out of specification■ Reduction of power supply voltage■ Wiring error■ Breaking of the connection wires between the indoor and outdoor units (wire No. 3)■ Defective outdoor unit PCB■ Short circuit inside the fan motor winding■ Defective indoor unit PCB■ Disturbed power supply waveform

Troubleshooting



Caution Be sure to turn off the power switch before connecting or disconnecting connectors, or parts may be damaged.

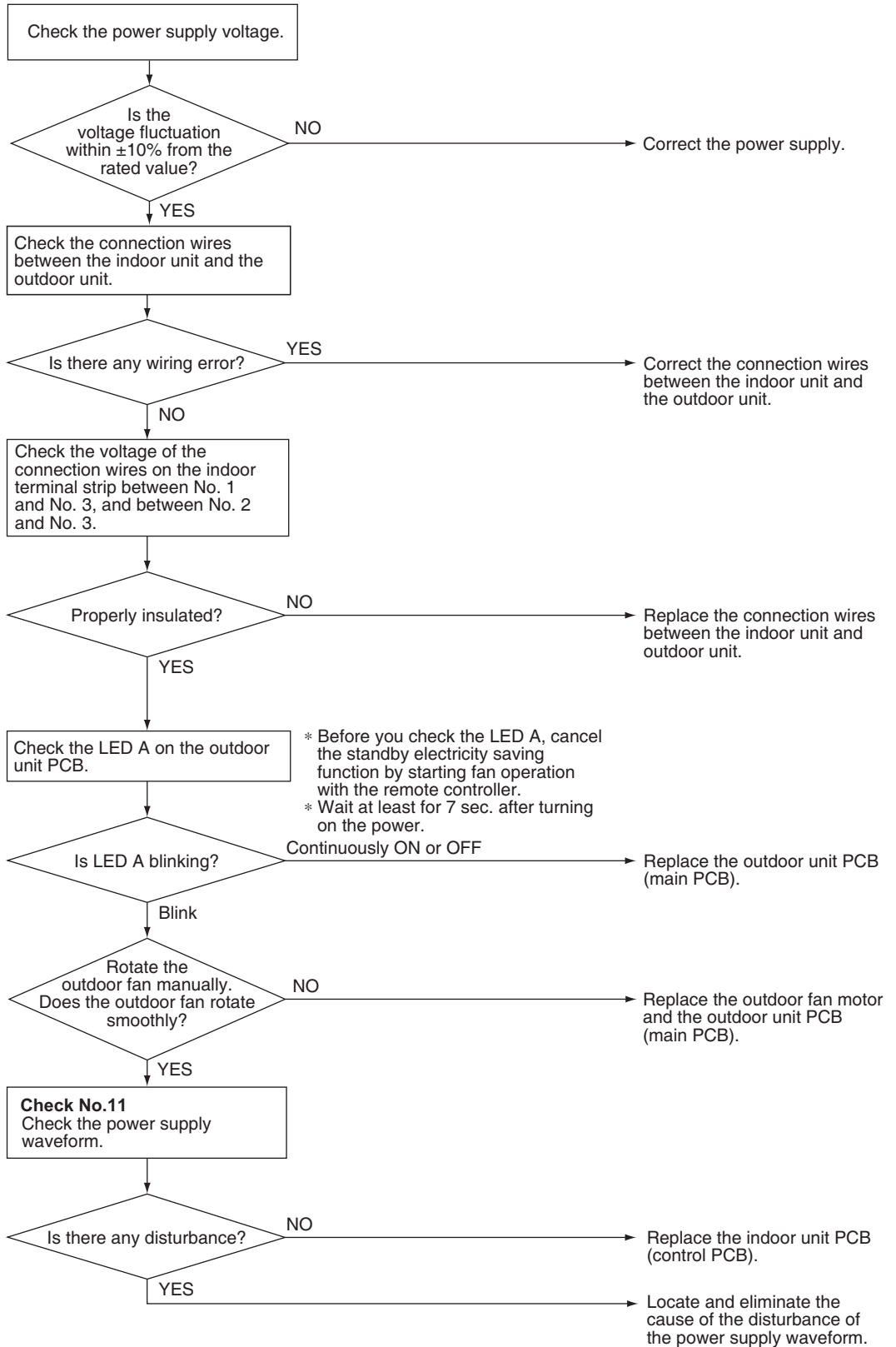

R6001029



Reference

Check No.11 Refer to P.281

7.10 Unspecified Voltage (Between Indoor Unit and Outdoor Unit)

Error Code	UA
Method of Error Detection	The supply power is detected for its requirements (pair type is different from multi type) by the indoor/outdoor transmission signal.
Error Decision Conditions	The pair type and multi type are interconnected.
Supposed Causes	<ul style="list-style-type: none"> ■ Wrong models interconnected ■ Wrong wiring of connecting wires ■ Wrong indoor unit PCB or outdoor unit PCB mounted ■ Defective indoor unit PCB ■ Defective outdoor unit PCB

Troubleshooting

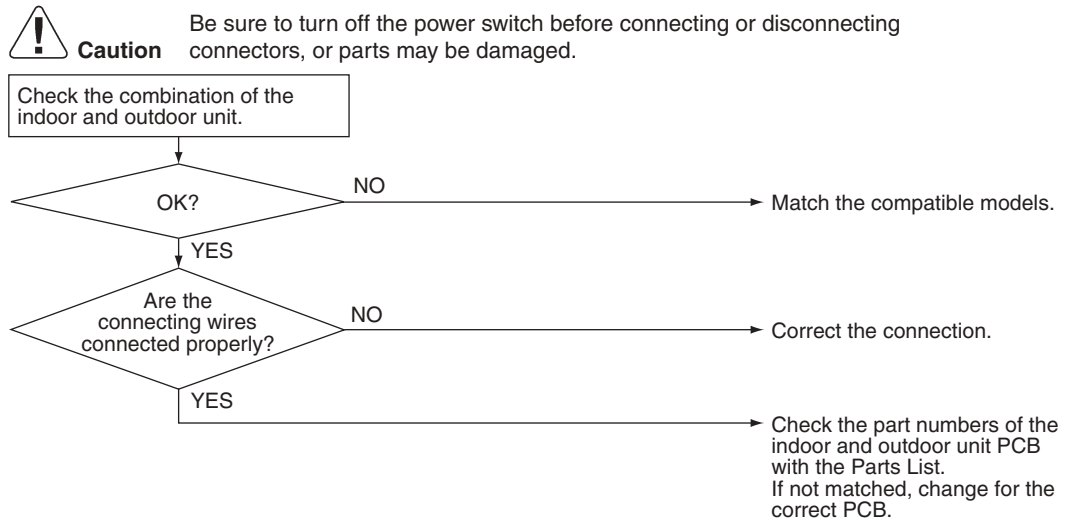

(R23289)

8. Troubleshooting for Air Handling Units

8.1 External Protection Device Abnormality

Error Code	A0-01
Method of Error Detection	Detect open or short circuit between external input terminals in indoor unit.
Error Decision Conditions	When an open circuit occurs between external input terminals.
Supposed Causes	<ul style="list-style-type: none"> ■ Open external input terminals (TB4-TB5) ■ Activation of external protection device ■ Defective indoor unit PCB ■ Indoor unit fuse blown ■ 24 VAC power is not supplied to TH2 and TR2 terminals on the indoor unit PCB.

Troubleshooting

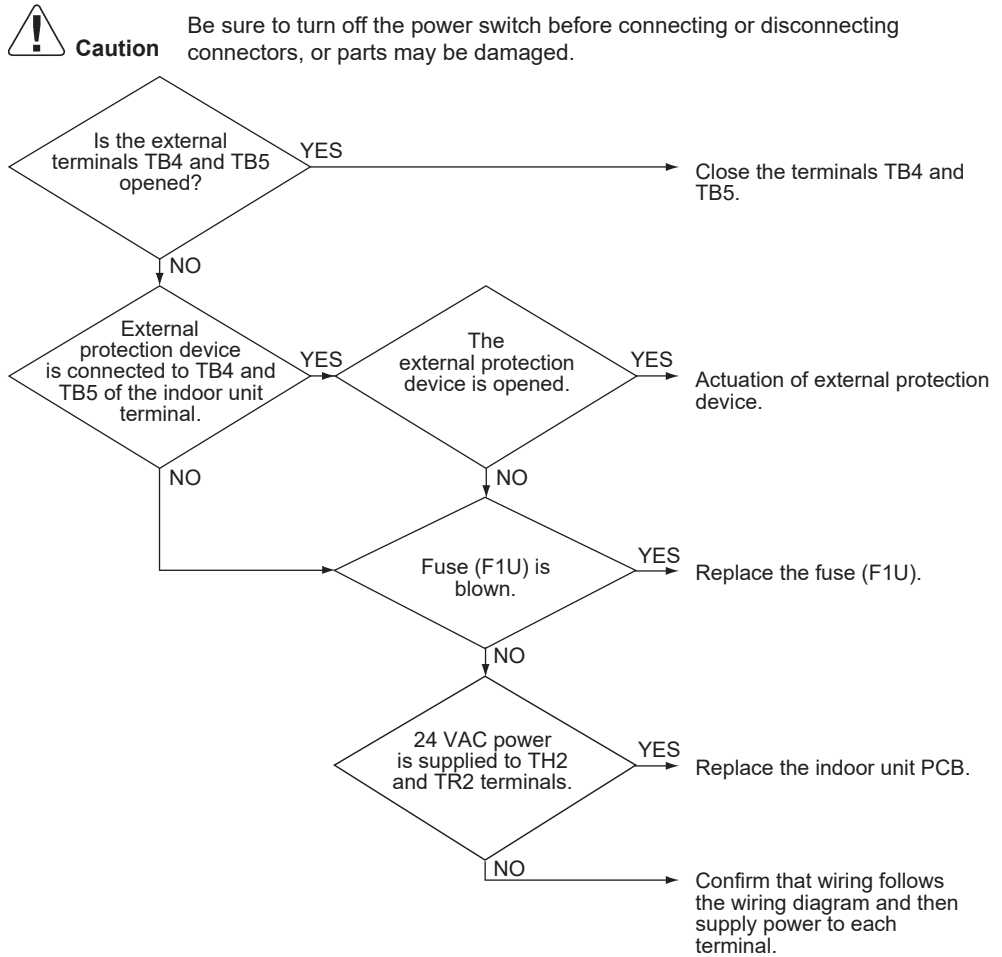

R6001347

8.2 Refrigerant Leak Detection (Confirmed) (CMXV Only)

Error Code	A0-17
Method of Error Detection	Refrigerant leak detection sensor detects a refrigerant leak for a long period of time.
Error Decision Conditions	When the A0-19 error detection status has occurred multiple times within a short period or continuously for a certain duration
Supposed Causes	<ul style="list-style-type: none"> ■ Refrigerant leak from system piping ■ Refrigerant leak detection sensor deterioration/failure ■ Defective control PCB

Troubleshooting



Caution

- Be sure to turn off the power switch before connecting or disconnecting connectors, or parts may be damaged.
- Refrigerant may be leaking.
- Please check the refrigerant leaking in a well-ventilated environment to prevent accumulation.
- Be careful to avoid generating fire or sparks.
- While this error is being detected, the unit will operate the fan to disperse the refrigerant. Be sufficiently careful not to injure yourself.
- Even if no refrigerant is confirmed after detection, the leak detection function will continue for 5 minutes.

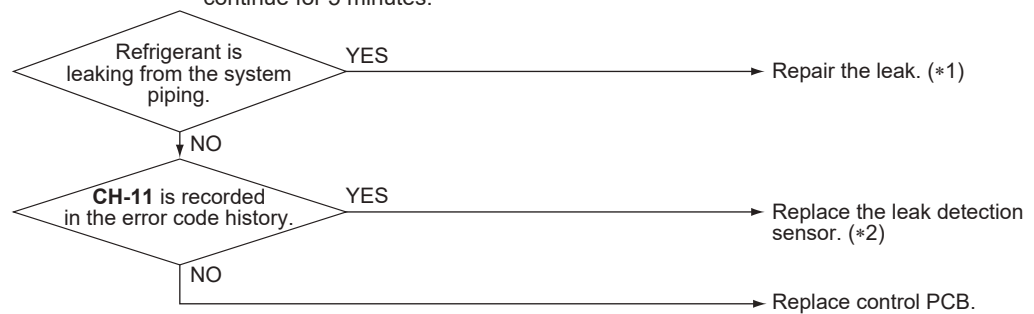

Note(s)

- *1. Sensor replacement is generally not necessary until **CH-11** or **CH-14** errors are detected.
- *2. For sensor replacement, refer to Refrigerant Leak Detection Sensor Replacement (CMXV only) on page 361.

8.3 Refrigerant Leak Detection (Monitoring)

Error Code	A0-19
Method of Error Detection	Refrigerant leak detection sensor detects a refrigerant leak.
Error Decision Conditions	When refrigerant concentrations exceeding the specified level are detected continuously during short-term sampling checks
Supposed Causes	<ul style="list-style-type: none"> ■ Refrigerant leak from system piping

Troubleshooting



Caution

- Be sure to turn off the power switch before connecting or disconnecting connectors, or parts may be damaged.
- Refrigerant may be leaking.
- Please check the refrigerant leaking in a well-ventilated environment to prevent accumulation.
- Be careful to avoid generating fire or sparks.
- While this error is being detected, the unit will operate the fan to disperse the refrigerant. Be sufficiently careful not to injure yourself.
- Even if no refrigerant is confirmed after detection, the leak detection function will continue for 5 minutes.

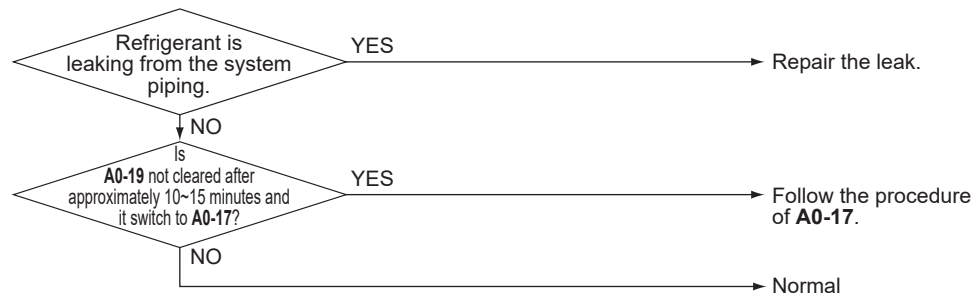

R6001342

8.4 Indoor Unit PCB Abnormality

Error Code	A1
Method of Error Detection	The system checks the data from EEPROM.
Error Decision Conditions	When the data from the EEPROM is not received correctly EEPROM (Electrically Erasable Programmable Read Only Memory): A memory chip that holds its content without power. It can be erased, either within the computer or externally and usually requires more voltage for erasure than the common +5 volts used in logic circuits. It functions like non-volatile RAM, but writing to EEPROM is slower than writing to RAM.
Supposed Causes	<ul style="list-style-type: none"> ■ Defective indoor unit PCB ■ External factor (noise etc.)

Troubleshooting

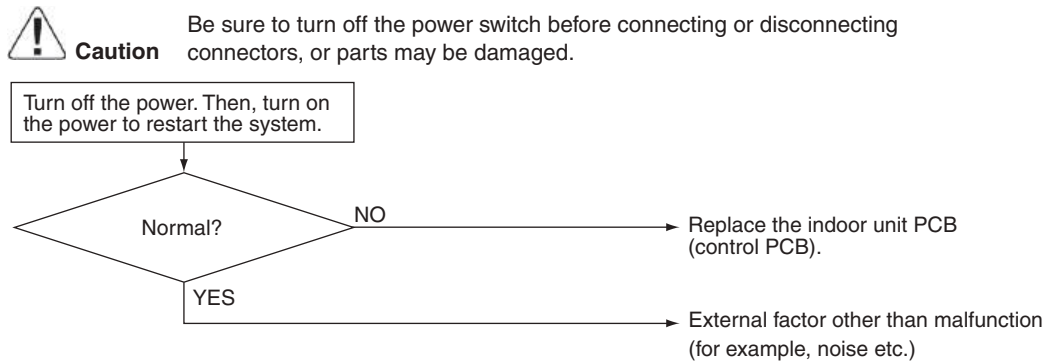

(R22247)

8.5 Blower Motor Not Running



Error Code	A6
Method of Error Detection	Error is issued if the indoor unit determines that the indoor fan motor cannot rotate.
Error Decision Conditions	<ul style="list-style-type: none"> ■ Determining successive abnormalities Checks the rotation speed at 5-second intervals using the feedback of the fan motor. If that figure falls below 50 rpm for the specified number of consecutive times successively, it is deemed abnormal operation. If, during operation, the rotation command is stopped, the 5-second interval check is halted and the counted number will be cleared. ■ Determining long-term abnormalities Checks the rotation speed at 5-second intervals using the feedback of the fan motor. Performs rotation sampling 720 times (takes approx. one hour), and if the rotation speed falls below 50 rpm over 100 times, it is deemed abnormal operation. When the sampling reaches 720 times, the counted number will be cleared and the 720 times sampling restarts. If, during this, the rotation command is stopped, the 5-second interval check is halted, but the counted number will be kept. When the rotation command is restarted, the checks will resume.
Error Reset Conditions	Reset by remote controller
Supposed Causes	<ul style="list-style-type: none"> ■ Fan or motor obstruction ■ Power interruption (low voltage) ■ Incorrect or loose wiring
Corrective Actions	<ul style="list-style-type: none"> ■ Check for obstruction on the fan or motor. ■ Verify the input voltage at the motor. ■ Check wiring or tighten wiring connections if needed. ■ Replace the indoor unit PCB or motor.



Reference

Check No.24 Refer to P.292

8.6 Indoor Fan Motor Status Abnormality

Error Code	A6-20
Method of Error Detection	The indoor unit periodically receives control status information from the fan motor. Error is issued when the information shows abnormality for 2 minutes successively.
Error Decision Conditions	If the information shows Power Limit or Temp Limit status, it will be deemed a MOTOR LIMIT abnormal operation. (The system can keep operating.)
Error Reset Conditions	If the indoor unit stops receiving abnormal information, the error will be cleared.
Supposed Causes	<ul style="list-style-type: none"> ■ Fan or motor obstruction ■ Blocked filters ■ Power interruption (low voltage) ■ Incorrect wiring ■ Blockage in the airflow (ductwork) or ductwork undersized ■ High loading conditions
Corrective Actions	<ul style="list-style-type: none"> ■ Check for obstruction on the fan, motor, or ductwork. ■ Clean filters. ■ Check filters, grille, duct system, heat exchanger air inlet/outlet for blockages. ■ Verify the input voltage at the motor. ■ Check wiring. ■ Replace motor.
 Reference	Check No.24 Refer to P.292
 Reference	Check No.29 Refer to P.298

8.7 Low Indoor Airflow

Error Code	A6-21
Method of Error Detection	Error is issued if the indoor unit determines that the indoor fan motor rotation is insufficient, regardless of the rotation command from indoor unit.
Error Decision Conditions	<ul style="list-style-type: none"> ■ Determining successive abnormalities Checks the rotation speed at 5-second intervals using the feedback of the fan motor. If that figure exceeds 50 rpm and falls below 150 rpm 10 times successively, it is deemed abnormal operation. If, during operation, the rotation command is stopped, the 5-second interval check is halted and the counted number will be cleared. ■ Determining long-term abnormalities Checks the rotation speed at 5-second intervals using the feedback of the fan motor. Performs rotation sampling 720 times (takes approximately one hour), and if the rotation speed exceeds 50 rpm and falls below 150 rpm over 360 times, it is deemed abnormal operation. When the counter reaches 720 times, the counted number will be cleared and the 720 times sampling restarts. If, during this, the rotation command is stopped, the 5-second interval check is halted, but the counted number will be kept. When the rotation command is restarted, the checks will resume.
Error Reset Conditions	<ul style="list-style-type: none"> ■ Determining successive abnormalities Checks the rotation speed at 5-second intervals using the feedback of the fan motor. If that figure exceeds 150 rpm even once, the error will be cleared. ■ Determining long-term abnormalities Checks the rotation speed at 5-second intervals using the feedback of the fan motor. If that figure exceeds 150 rpm 36 times successively, the error will be cleared. At that point, the counted number and sampling number will be cleared, and the 720 times sampling starts again from the beginning.
Supposed Causes	<ul style="list-style-type: none"> ■ Fan or motor obstruction ■ Blocked filters ■ Restrictive ductwork or ductwork undersized ■ Wiring disconnected ■ Wrong outdoor and indoor combination ■ Indoor fan motor failure
Corrective Actions	<ul style="list-style-type: none"> ■ Check for obstruction on the fan or motor. ■ Check ductwork and filter for blockage. ■ Clean filters. ■ Remove obstruction. Verify all registers are fully open. ■ Check the connections and the rotation of the motor. ■ Verify the input voltage at the motor. ■ Verify ductwork is appropriately sized for system. Resize or replace ductwork if needed. ■ Replace motor.
 Reference	Check No.24 Refer to P.292

8.8 Defective Capacity Setting

Error Code	AJ
Method of Error Detection	Error is issued when the saved data inside the microcomputer and/or the DIP switch settings on the control PCB are abnormal.
Error Decision Conditions	<ul style="list-style-type: none"> ■ When capacity data does not exist in the microcomputer. ■ When the DIP switch settings on the control PCB are incorrect.
Supposed Causes	<ul style="list-style-type: none"> ■ Defective indoor unit control PCB ■ The DIP switches are incorrect.

Troubleshooting

 **Caution** Be sure to turn off the power switch before connecting or disconnecting connectors, or parts may be damaged.

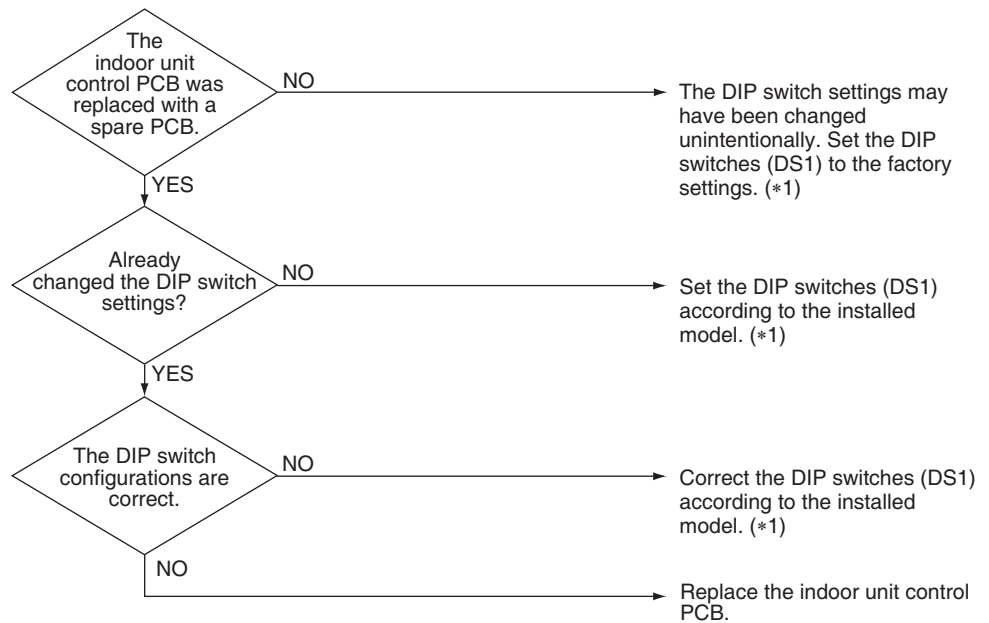

R6001424

 **Note(s)** *1. Refer to Setting of DIP Switches (CMXV Only) on page 331.

8.9 Blower Motor Communication Error

Error Code	C1-07
Method of Error Detection	Error is issued if transmission abnormalities occur between indoor unit and fan motor.
Error Decision Conditions	If the response message from the fan motor is an abnormal message, and determined as such by the indoor unit, the indoor unit will execute a retry. If everything fails for 5 seconds, it is deemed to be a transmission abnormality.
Error Reset Conditions	If the indoor unit receives even a single normal response message from the fan motor, the error will be cleared.
Supposed Causes	<ul style="list-style-type: none">■ Incorrect or loose wiring■ Power interruption (low voltage)
Corrective Actions	<ul style="list-style-type: none">■ Check wiring or tighten wiring connections if needed.■ Verify the input voltage at the motor.■ Replace the indoor unit PCB or motor.

8.10 Thermistor/Pressure Sensor or Related Abnormality

Error Code	C4, C5, C9
Method of Error Detection	The temperatures detected by the thermistors determine thermistor errors. The pressure detected by the pressure sensor determines pressure sensor errors.
Error Decision Conditions	The thermistor and/or pressure sensor is disconnected or shorted while the unit is running.
Supposed Causes	<ul style="list-style-type: none"> ■ Disconnection of connector ■ Defective thermistor(s) ■ Defective pressure sensor ■ Breaking of wires ■ Defective indoor unit PCB

Troubleshooting If the cause of the problem is related to the thermistors, the thermistors and/or pressure sensors should be checked prior to changing the indoor unit PCB.

To check the thermistors/pressure sensors, proceed as follows:

1. Disconnect the thermistor/pressure sensor from the indoor unit PCB.
2. Read the temperature/pressure and the resistance value.
3. Check if the measured values correspond with the values in the table of thermistor /pressure sensor resistance check.

 **Caution** Be sure to turn off the power switch before connecting or disconnecting connectors, or parts may be damaged.

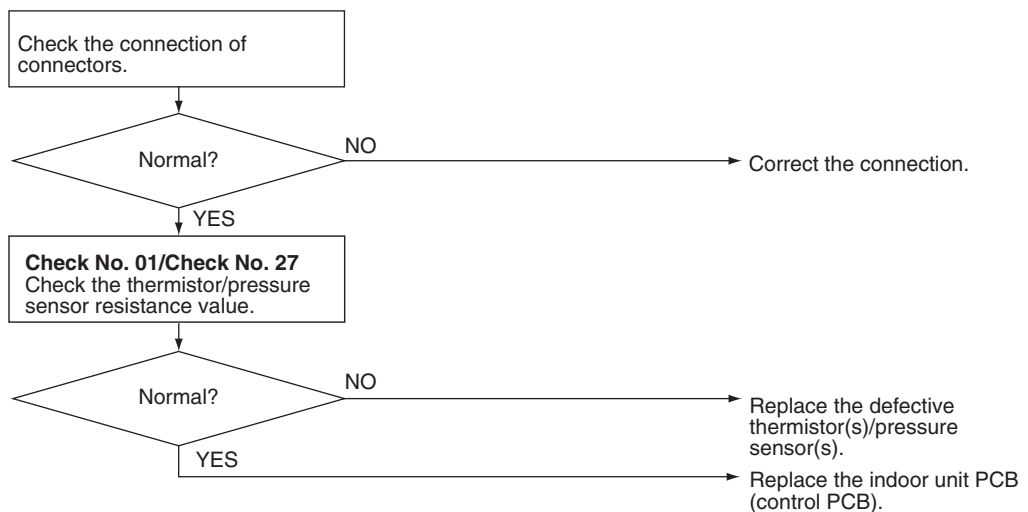

R6001425

C4: Indoor heat exchanger thermistor 1 (liquid pipe) (R2T)

C5: Indoor heat exchanger thermistor 2 (R3T) or indoor pressure sensor (CMXV only)

C9: Room temperature thermistor (R1T)

 **Reference**

Check No.01 Refer to P.278

 **Reference**

Check No.27 Refer to P.297

 **Note**

(CMXV Only) If the **C9** error code cannot be cleared after performing the above troubleshooting for the CMXV model, reset field setting (Refer to Overview of Field Settings for CMXV on page 327)

8.11 Blower Motor HP Mismatch

Error Code	C6-01
Method of Error Detection	Error is issued if the manufacturer ID and output of the connected fan motor do not match those recognized by the indoor unit.
Error Decision Conditions	Gathers information on the manufacturer ID and output of the fan motor when initializing the fan motor. If those figures are not the values recognized by the indoor unit, it will be deemed abnormal operation. If deemed abnormal operation, it will keep retrying until the figures match.
Error Reset Conditions	If the manufacturer ID and output match, the error will be cleared.
Supposed Causes	<ul style="list-style-type: none">■ Incorrect size motor■ Indoor unit capacity setting error
Corrective Actions	<ul style="list-style-type: none">■ Correct motor installation.■ Correct the indoor unit capacity setting.

8.12 Refrigerant Leak Detection Sensor Failure (CMXV Only)

Error Code	CH-11
Method of Error Detection	Error is issued when control PCB receives fault status from leak detection sensor.
Error Decision Conditions	<ul style="list-style-type: none"> ■ When leak detection sensor sends fault status information to control PCB for a certain set timeframe.
Supposed Causes	<ul style="list-style-type: none"> ■ Broken leak detection sensor ■ Defective control PCB

Troubleshooting



Caution Be sure to turn off the power switch before connecting or disconnecting connectors, or parts may be damaged.

While **CH-11** is being detected, the fan motor is forced to operate in compliance with safety standards.

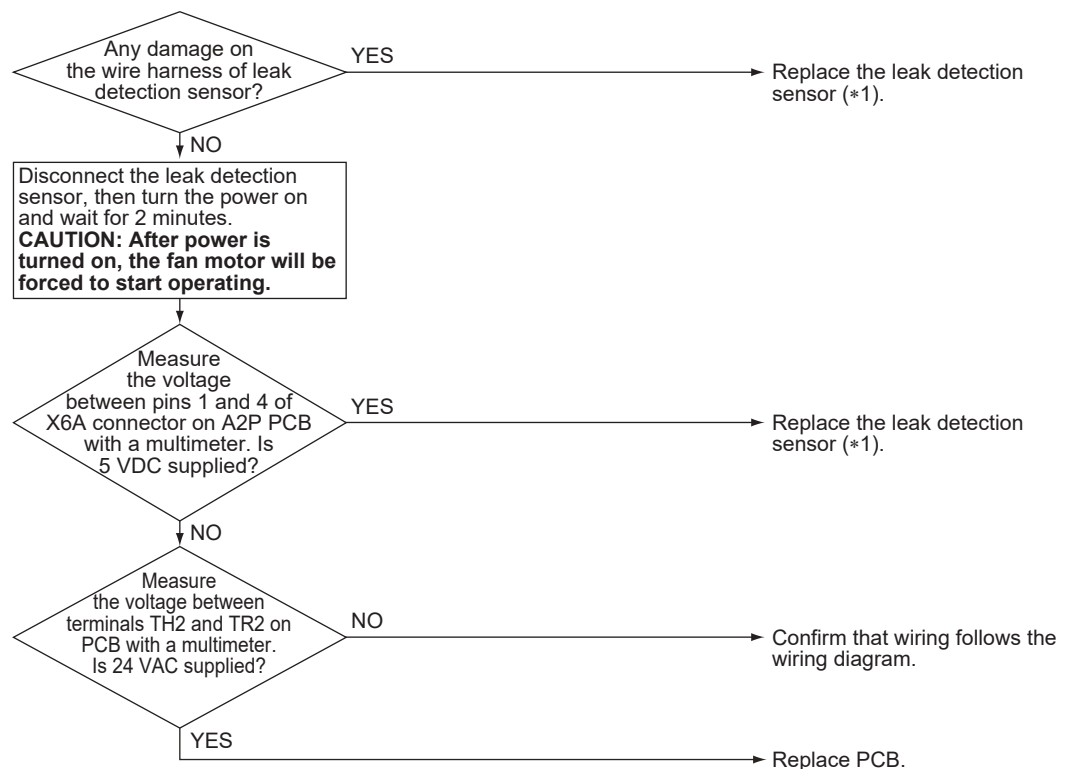

Note(s)

*1. For sensor replacement, refer to Refrigerant Leak Detection Sensor Replacement (CMXV models only) on page 361.

8.13 Refrigerant Leak Detection Sensor Disconnection (CMXV Only)

Error Code

CH-14

Method of Error Detection

Error is issued when leak detection sensor is not connected to control PCB or communication with the control PCB is lost.

Error Decision Conditions

When control PCB does not have a connection with leak detection sensor at startup.

Supposed Causes

- Disconnected leak detection sensor
- Broken wires in, short circuit of, or disconnection of connector of leak detection sensor
- Incorrect wiring
- Defective control PCB

Troubleshooting



Caution

Be sure to turn off the power switch before connecting or disconnecting connectors, or parts may be damaged.

While **CH-14** is being detected, the fan motor is forced to operate in compliance with safety standards.

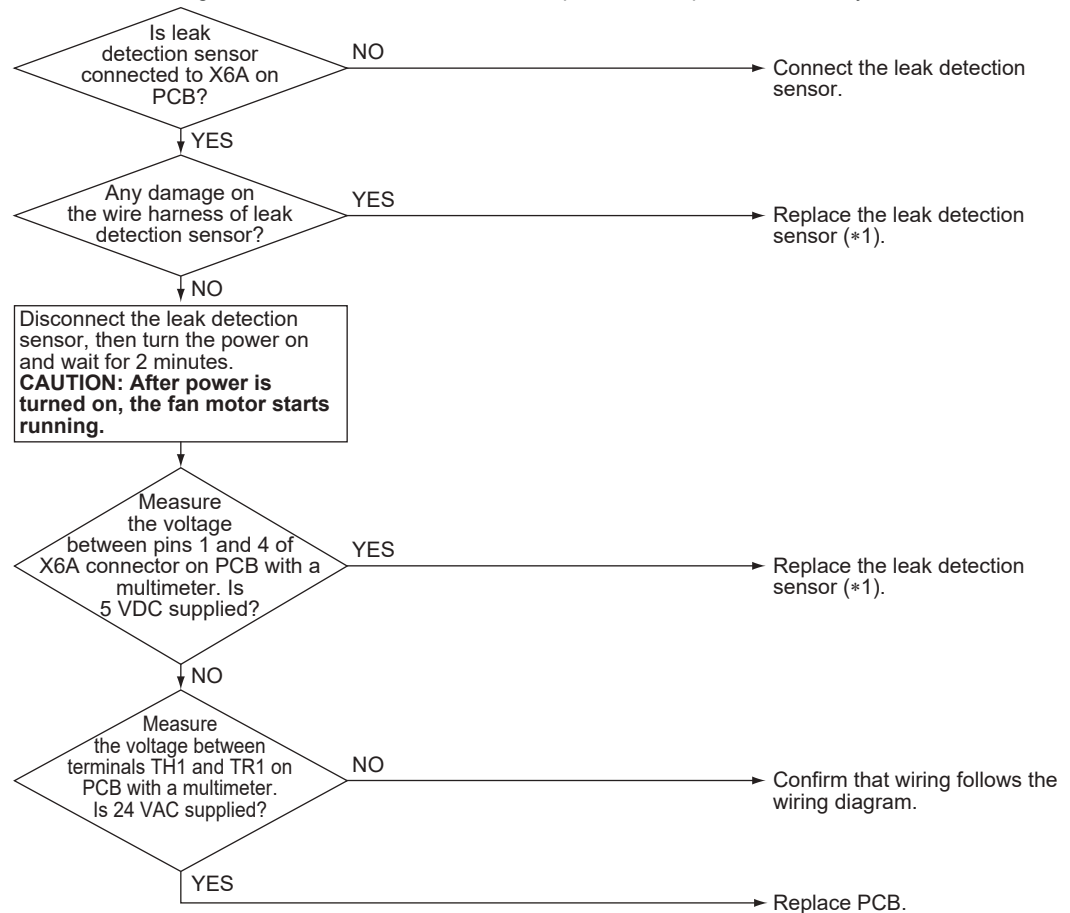

Note(s)

*1. For sensor replacement, refer to Refrigerant Leak Detection Sensor Replacement (CMXV models only) on page 361.

8.14 Signal Transmission Error (Between Indoor Unit and Outdoor Unit)

Error Code	U4
Method of Error Detection	The signal transmission data received from the outdoor unit is checked whether it is normal.
Error Decision Conditions	The data sent from the outdoor unit cannot be received normally, or the content of the data is abnormal.
Supposed Causes	<ul style="list-style-type: none"> ■ Power supply voltage out of specification ■ Reduction of power supply voltage ■ Wiring error ■ Breaking of the connection wires between the indoor and outdoor units (wire No. 3) ■ Defective outdoor unit PCB ■ Short circuit inside the fan motor winding ■ Defective indoor unit PCB ■ Disturbed power supply waveform

Troubleshooting



Caution Be sure to turn off the power switch before connecting or disconnecting connectors, or parts may be damaged.

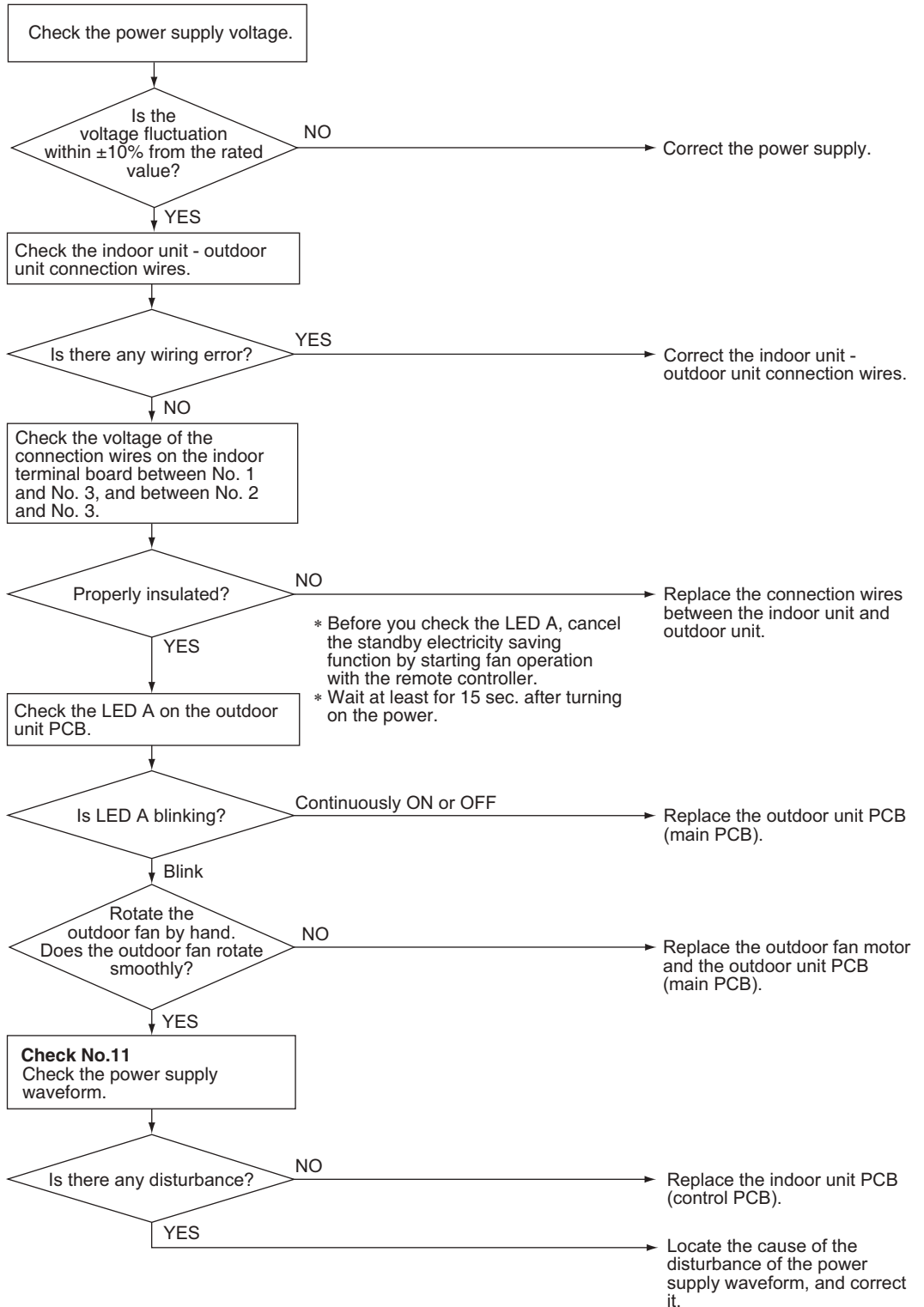

R6000963



Reference Check No.11 Refer to P.281



Reference Check No.25 Refer to P.296

8.15 Signal Transmission Error (Between Indoor Unit and Remote Controller)

Error Code	U5
Method of Error Detection	Daikin One Thermostat determines whether the signal transmission with indoor unit is normal.
Error Decision Conditions	Normal transmission does not continue for specified period.
Supposed Causes	<ul style="list-style-type: none"> ■ Defective indoor unit PCB ■ Defective remote controller ■ Transmission error caused by noise

Troubleshooting

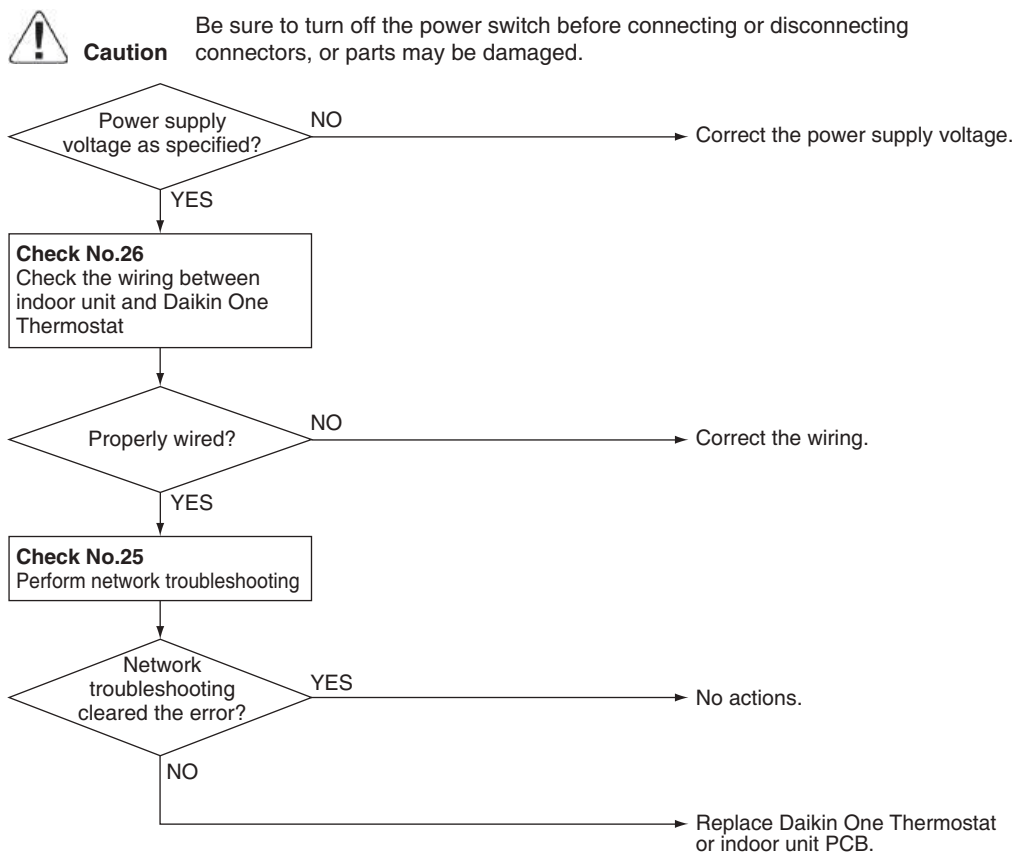

R6001432

 **Reference** **Check No.25** Refer to P.296

 **Reference** **Check No.26** Refer to P.296

8.16 Unspecified Voltage (Between Indoor Unit and Outdoor Unit)

Error Code	UA
Error Decision Conditions	Improper combination of indoor and outdoor units
Supposed Causes	<ul style="list-style-type: none"> ■ Defective indoor unit PCB ■ Indoor-outdoor unit transmission wiring error ■ Defective optional unit(s) wirings ■ Improper power supply wiring of indoor unit ■ Improper wiring of connecting wires between indoor/outdoor units

Troubleshooting



Caution Be sure to turn off the power switch before connecting or disconnecting connectors, or parts may be damaged.

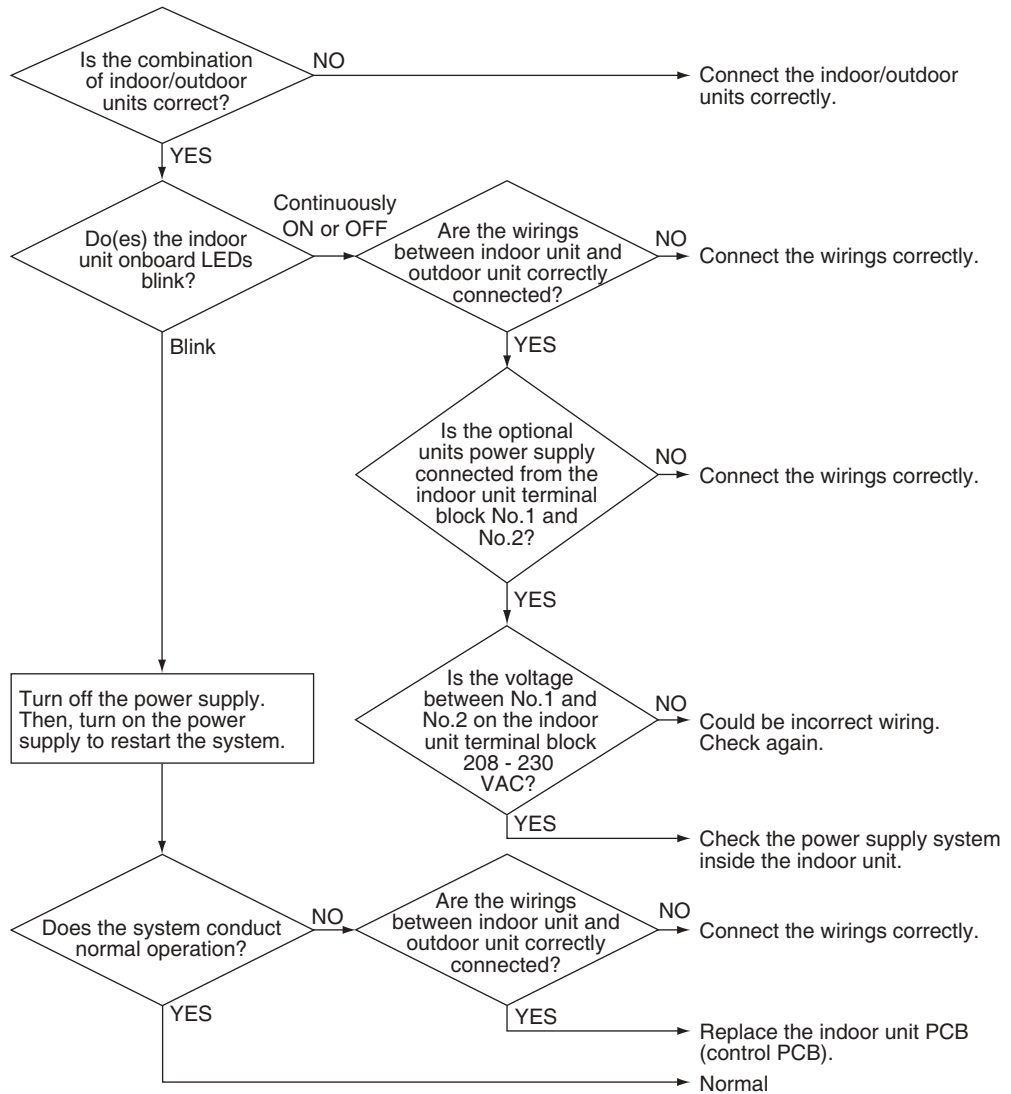







R6001433

8.17 Incorrect Electric Heater Capacity Setting

Error Code	UA-17
Method of Error Detection	After attaching optional electric heater, if the electric heater capacity setting [Field setting 5] is made mistakenly for heaters not featured in the lineup, heating via unintended levels of airflow will be prevented. However, the electric heater will be operable for convenience.
Error Decision Conditions	Checks when the capacity setting [Field setting 5] of the electric heater has been set to a non-applicable value.
Operation After Error Codes Decided	<ul style="list-style-type: none"> ■ The error code UA-17 is displayed on the remote controller. ■ Indoor units can operate continuously. ■ Incorrect setting is kept. ■ Even if the ON condition for electric heater 2 is established, only electric heater 1 will be set to ON. (Electric heater 1 set to ON, electric heater 2 set to OFF) (In order to deliver in terms of user-friendliness and safety, the electric heater can operate at the lowest possible power levels.) ■ The airflow of the fan during operation of the electric heater will be set to the largest value within the CFM dictated by the capacity of each of the electric heaters (electric heater 1, electric heater 2 both set to ON). ■ All other operations are the same as during normal operation.

9. Troubleshooting for Outdoor Unit

9.1 Refrigerant Shortage

Error Code	U0																						
Outdoor Unit LED Display	A  1  2  3  4  5 																						
Method of Error Detection	Refrigerant shortage is detected by checking the input current value and the compressor running speed. If there is insufficient refrigerant, the input current tends to be lower than the normal value.																						
Error Decision Conditions	<p>The following conditions continue for 7 minutes.</p> <ul style="list-style-type: none"> ■ Input current $\leq A \times$ output compressor speed + B ■ Output compressor speed $> C$ <table border="1"> <thead> <tr> <th></th> <th>2MXM</th> <th>3/4MXM</th> <th>2/3MXT(H)</th> </tr> </thead> <tbody> <tr> <td>A (coefficient)</td> <td>10/1000</td> <td>27/1000</td> <td>27/1000</td> </tr> <tr> <td>B (A)</td> <td>0.3</td> <td>2</td> <td>2</td> </tr> <tr> <td>C (rps)</td> <td>40</td> <td>40</td> <td>40</td> </tr> </tbody> </table> <ul style="list-style-type: none"> ■ Power consumption $\leq A \times$ output compressor speed + B ■ Output compressor speed $> C$ <table border="1"> <tbody> <tr> <td>A (coefficient)</td> <td>2500/256</td> </tr> <tr> <td>B (W)</td> <td>50</td> </tr> <tr> <td>C (rps)</td> <td>40</td> </tr> </tbody> </table> <ul style="list-style-type: none"> ■ If the error repeats, the system is shut down. ■ Reset condition: Continuous run for about 60 minutes without any other error 		2MXM	3/4MXM	2/3MXT(H)	A (coefficient)	10/1000	27/1000	27/1000	B (A)	0.3	2	2	C (rps)	40	40	40	A (coefficient)	2500/256	B (W)	50	C (rps)	40
	2MXM	3/4MXM	2/3MXT(H)																				
A (coefficient)	10/1000	27/1000	27/1000																				
B (A)	0.3	2	2																				
C (rps)	40	40	40																				
A (coefficient)	2500/256																						
B (W)	50																						
C (rps)	40																						
Supposed Causes	<ul style="list-style-type: none"> ■ The installation space not large enough ■ Dirty outdoor heat exchanger ■ Defective outdoor fan motor ■ Disconnection of the discharge pipe thermistor, indoor or outdoor heat exchanger thermistor, room or outdoor temperature thermistor ■ Closed stop valve ■ Refrigerant shortage (refrigerant leakage) ■ Poor compression performance of compressor ■ Defective electronic expansion valve 																						

Troubleshooting





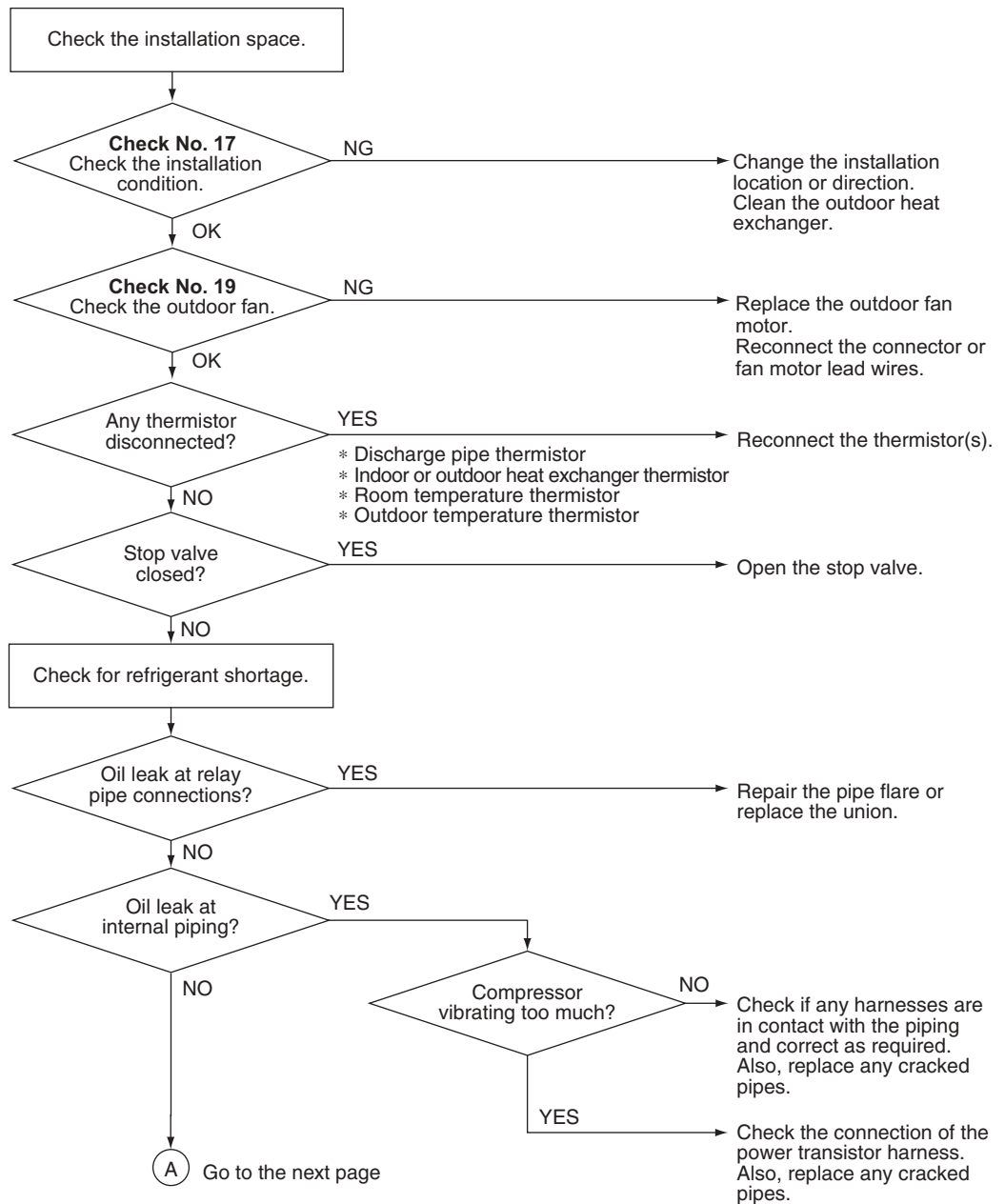

Caution Be sure to turn off the power switch before connecting or disconnecting connectors, or parts may be damaged.

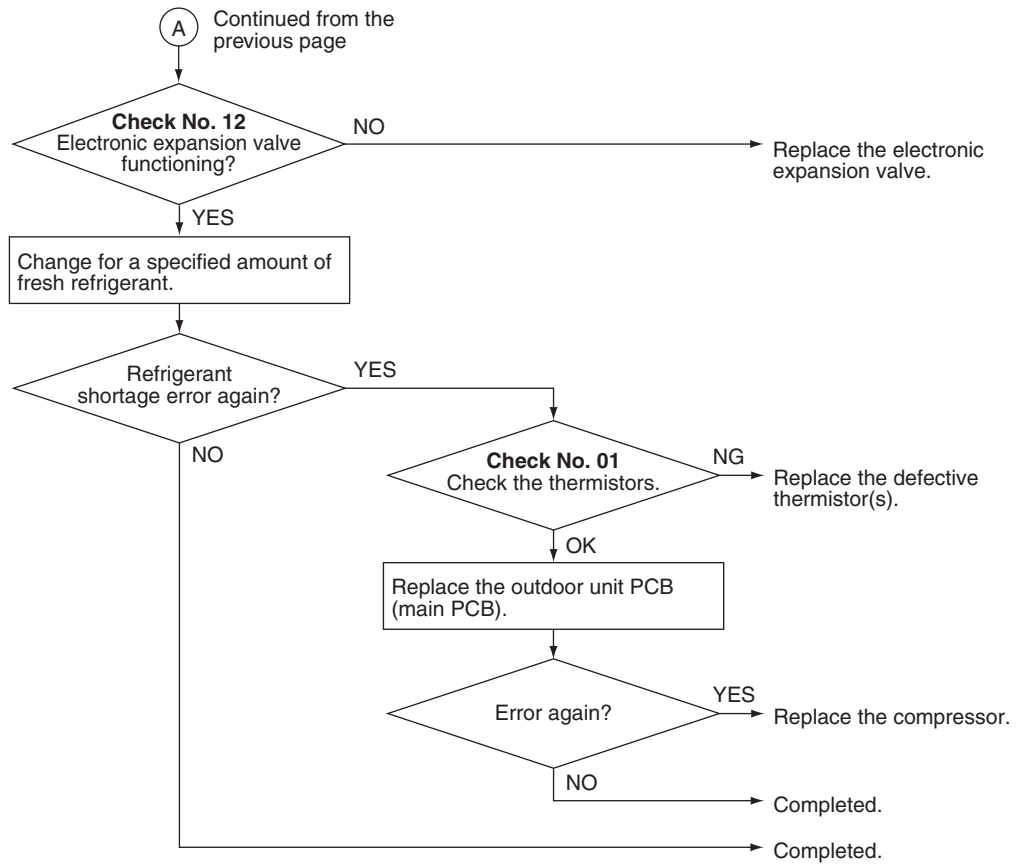



R6000442



R6000552

-  **Reference** **Check No.01** Refer to P.278
-  **Reference** **Check No.12** Refer to P.281
-  **Reference** **Check No.17** Refer to P.286
-  **Reference** **Check No.19** Refer to P.287

9.2 Low-voltage Detection or Over-voltage Detection

Error Code	U2		
Outdoor Unit LED Display	A  1  2 ● 3 ● 4  5 ●		
Method of Error Detection	<p>■ Indoor Unit</p> <p>The zero-cross detection of the power supply is evaluated by the indoor unit PCB.</p> <p>■ Outdoor Unit</p> <p>Low-voltage detection: An abnormal voltage drop is detected by the DC voltage detection circuit.</p> <p>Over-voltage detection: An abnormal voltage rise is detected by the over-voltage detection circuit.</p>		
Error Decision Conditions	<p>■ Indoor Unit</p> <p>There is no zero-cross detection in approximately 10 seconds.</p> <p>■ Outdoor Unit</p> <p>Low-voltage detection:</p> <ul style="list-style-type: none"> ■ The voltage detected by the DC voltage detection circuit is below A V for 0.1 second. ■ If the error repeats, the system is shut down. ■ Reset condition: Continuous run for about 60 minutes without any other error <table border="1" style="width: 100%; border-collapse: collapse;"> <tr> <td style="padding: 2px;">A (V)</td> <td style="padding: 2px; text-align: center;">170</td> </tr> </table> <p>Over-voltage detection:</p> <ul style="list-style-type: none"> ■ An over-voltage signal is fed from the over-voltage detection circuit to the microcomputer. ■ The compressor stops if the error occurs, and restarts automatically after 3-minute standby. 	A (V)	170
A (V)	170		
Supposed Causes	<ul style="list-style-type: none"> ■ Power supply voltage out of specification ■ Defective DC voltage detection circuit ■ Defective over-voltage detection circuit ■ Defective PAM control part ■ Disconnection of compressor harness ■ Short circuit inside the fan motor winding ■ Noise ■ Momentary drop of voltage ■ Momentary power failure ■ Defective outdoor unit PCB ■ Defective indoor unit PCB 		

Troubleshooting



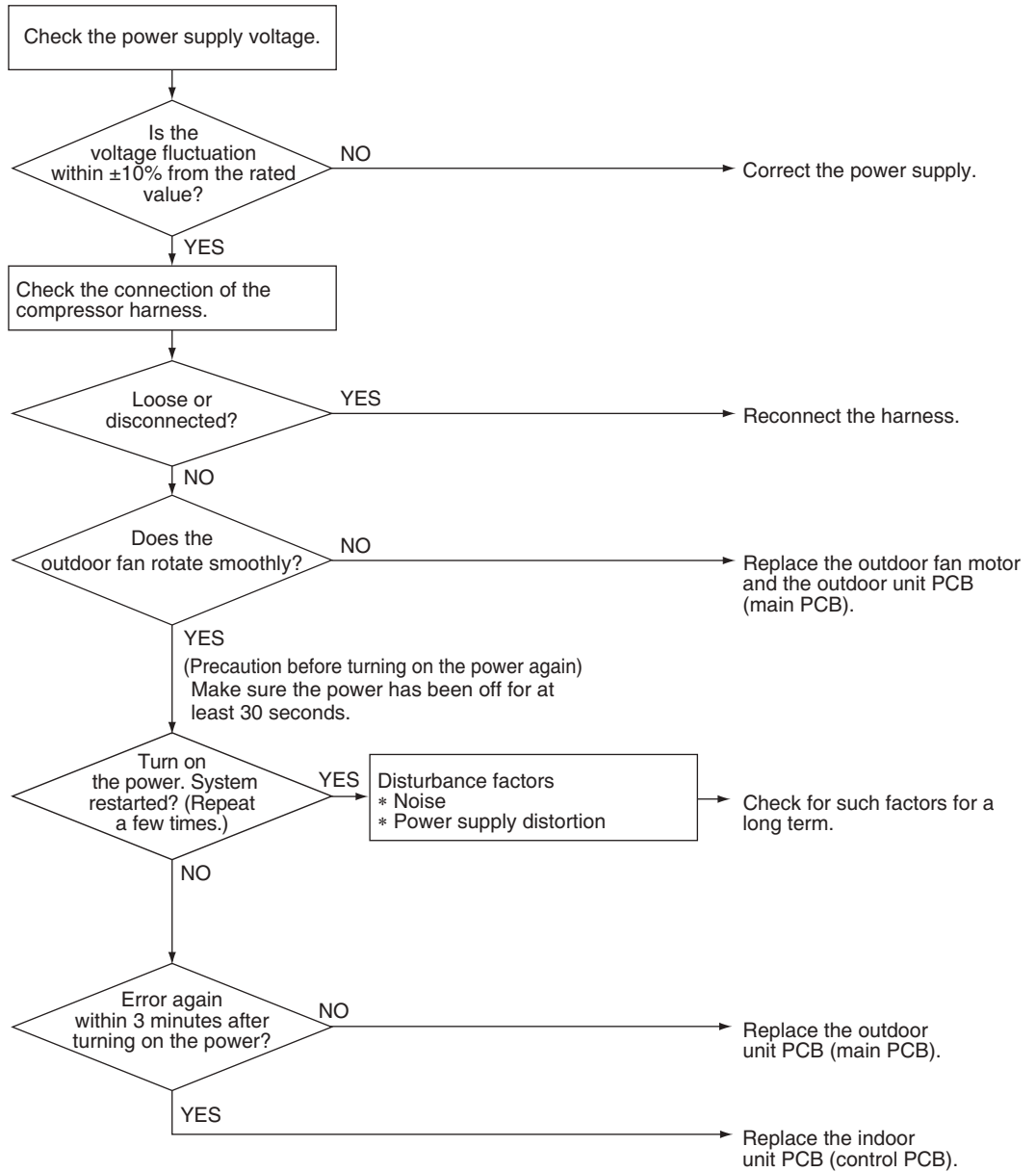

**Caution**

Be sure to turn off the power switch before connecting or disconnecting connectors, or parts may be damaged.



(R22370)

9.3 Wiring Error Check Unexecuted

Error Code	U3
Outdoor Unit LED Display	A  1 ●  2  3 ●  4 ●  5 ●
Method of Error Detection	The system checks if wiring error check is executed after clearing the memory.
Error Decision Conditions	An error is determined when the unit is operated by the remote controller without executing wiring error check after the memory was cleared.
Supposed Causes	The wiring error switch (SW3) may have been pressed for 10 seconds or more and the memory may have been deleted. The unit cannot be operated unless wiring error check is executed.

Troubleshooting

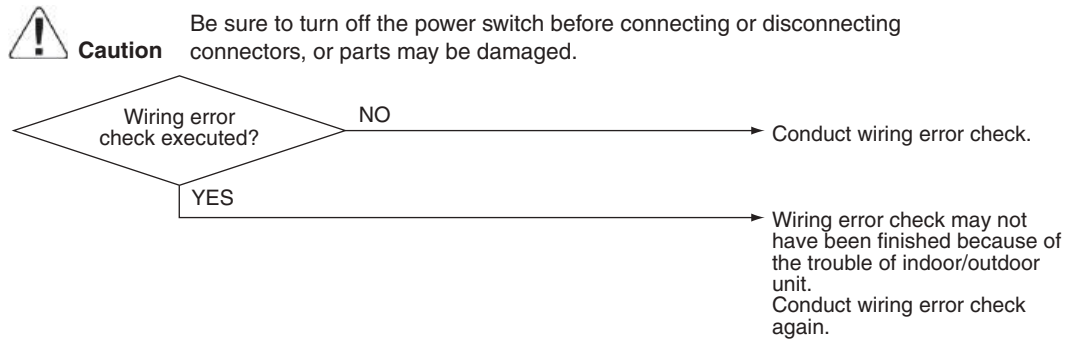

(R23952)



Reference

Refer to Wiring Error Check Function on page 302 for details.

9.4 Unspecified Voltage (Between Indoor Unit and Outdoor Unit), Anti-icing Control in Other Rooms

Error Code	UA, UH
Outdoor Unit LED Display	A ● 1 ● 2 ● 3 ● 4 ● 5 ●
Method of Error Detection	A wrong connection is detected by checking the combination of indoor and outdoor units on the microcomputer.
Error Decision Conditions	<ul style="list-style-type: none"> ■ Anti-icing control in other rooms ■ Unspecified internal and/or external voltages ■ Mismatching of indoor and outdoor units
Supposed Causes	<ul style="list-style-type: none"> ■ Anti-icing function in other rooms ■ Power supply voltage out of specification ■ Wrong models interconnected ■ Wrong indoor unit PCB or outdoor unit PCB mounted

Troubleshooting

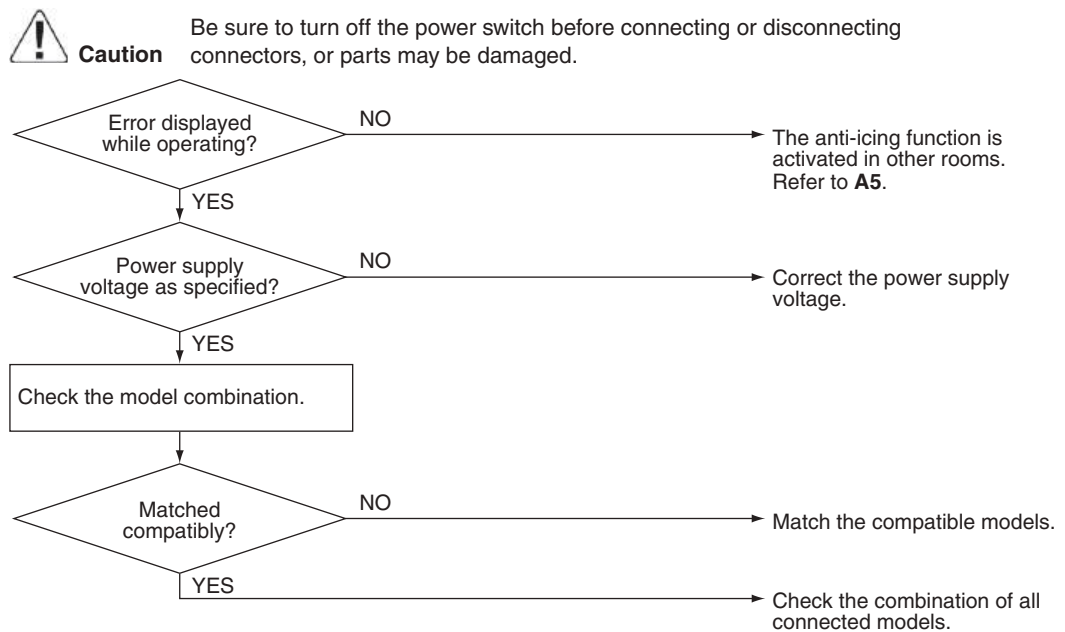





(R21922)

Note

Refer to Anti-icing control for indoor unit on page 245 for details.

9.5 Anti-icing Control for Indoor Unit

Error Code	A5
Outdoor Unit LED Display	A  1  2  3  4  5
Method of Error Detection	During cooling operation, indoor unit icing is detected by checking the temperatures sensed by the indoor heat exchanger thermistor and room temperature thermistor that are located in a shut-down room.
Error Decision Conditions	<ul style="list-style-type: none"> ■ In cooling operation, the both conditions (A) and (B) are met for 5 minutes. <ul style="list-style-type: none"> (A) Room temperature – Indoor heat exchanger temperature $\geq 10^{\circ}\text{C}$ (18°F) (B) Indoor heat exchanger temperature $\leq -1^{\circ}\text{C}$ (30.2°F) ■ If the error repeats, the system is shut down. ■ Reset condition: 3-minute standby is over and the indoor heat exchanger temperature is above 0°C (32°F)
Supposed Causes	<ul style="list-style-type: none"> ■ Wrong wiring or piping ■ Defective electronic expansion valve ■ Short-circuited air ■ Defective indoor heat exchanger thermistor ■ Defective room temperature thermistor

Troubleshooting



Caution Be sure to turn off the power switch before connecting or disconnecting connectors, or parts may be damaged.

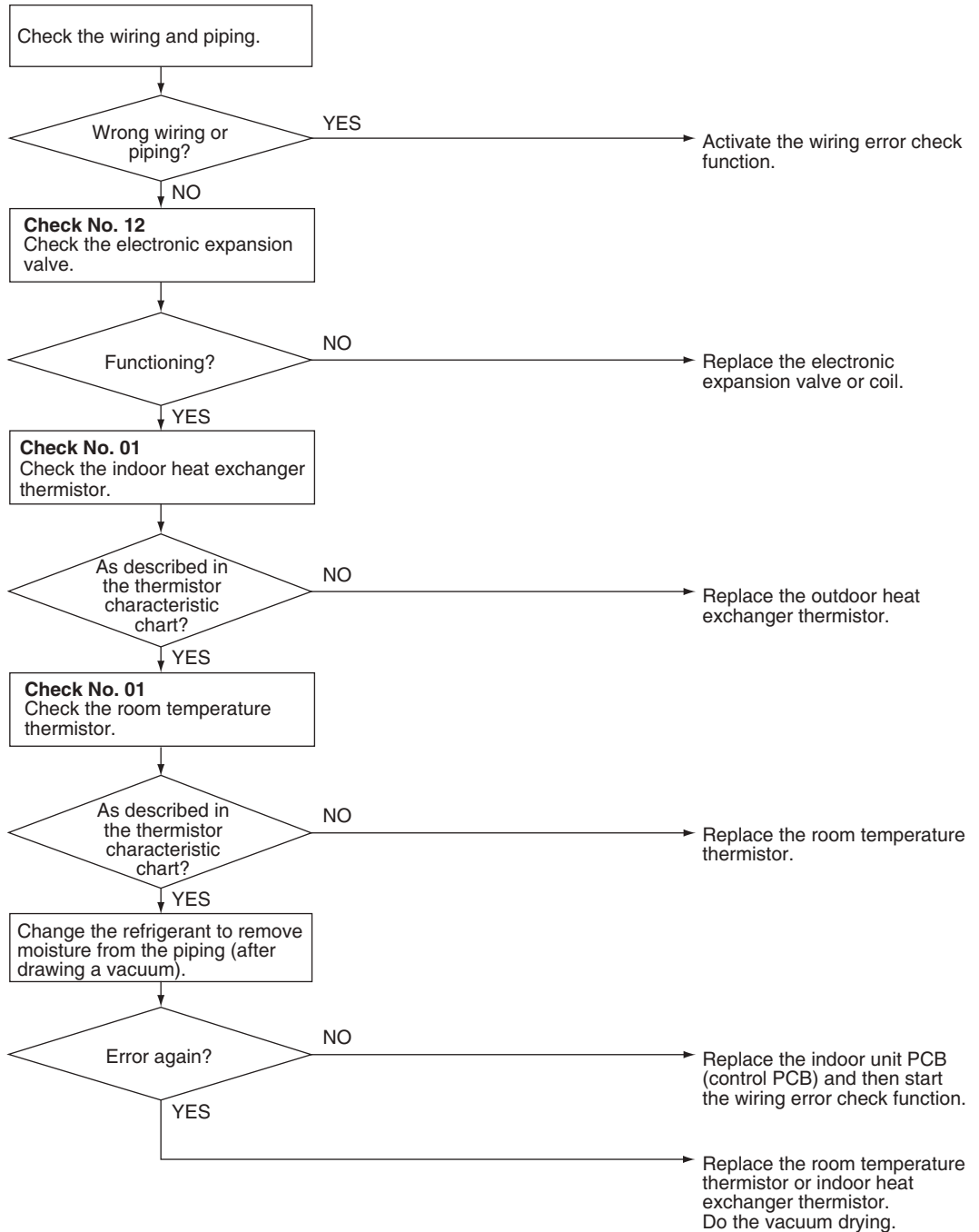

R6001320









Reference Check No.01 Refer to P.278



Reference Check No.12 Refer to P.281

9.6 Outdoor Unit PCB Abnormality



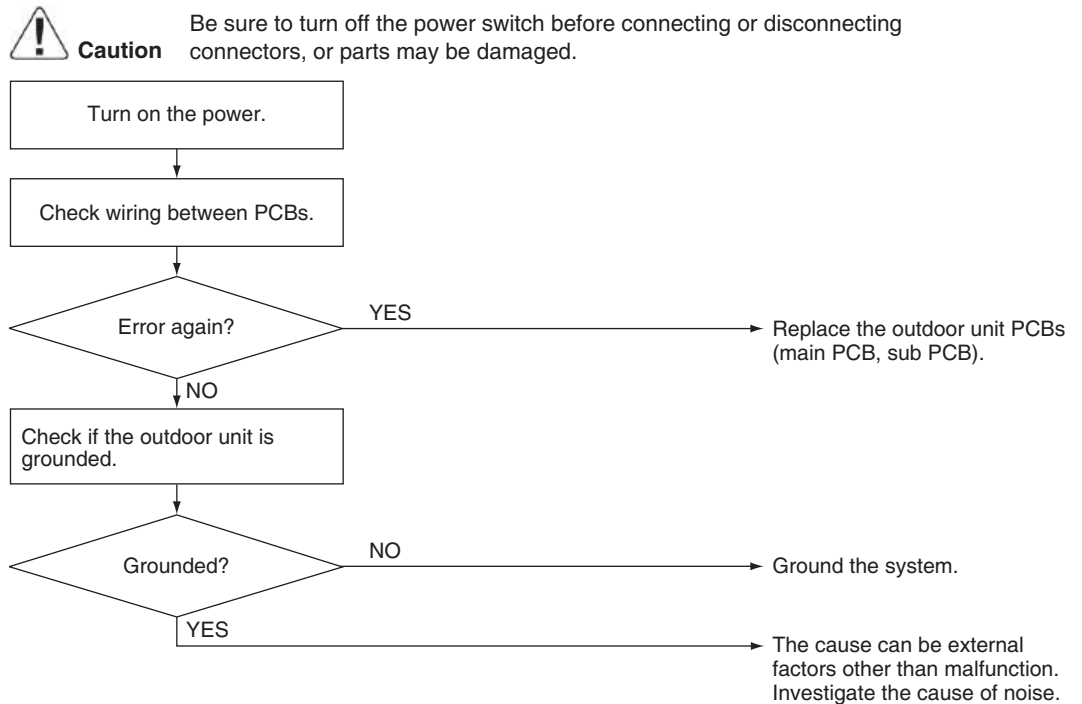

Error Code	E1
Outdoor Unit LED Display	A  1  2  3  4  5  6
Method of Error Detection	Detect within the program of the microcomputer.
Error Decision Conditions	The program of the microcomputer is in abnormal running order.
Supposed Causes	<ul style="list-style-type: none"> ■ Defective outdoor unit PCB ■ Defective electronic expansion valve driver ■ Defective IGBT temperature detection thermistor circuit ■ Defective Fan IPM temperature detection thermistor circuit ■ Fan IPM temperature error ■ IGBT temperature error ■ ACS transmission error ■ Communication error between PCBs ■ Noise ■ Momentary drop of voltage ■ Momentary power failure

Troubleshooting



R6001191

9.7 Actuation of High Pressure Switch

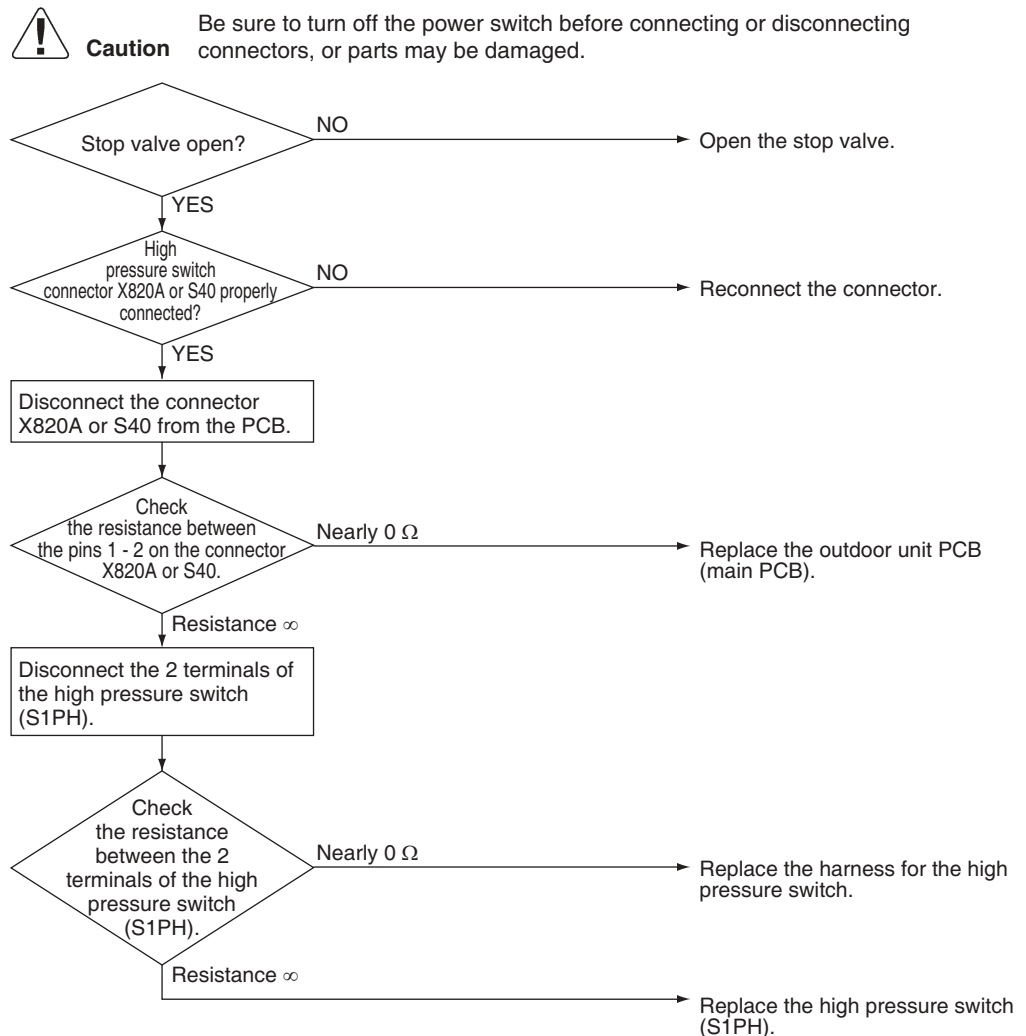

Error Code	E3
Outdoor Unit LED Display	A  1  2  3  4  5
Method of Error Detection	Abnormality is detected when the contact of the high pressure switch opens.
Error Decision Conditions	<ul style="list-style-type: none"> ■ High pressure switch (S1PH) activating pressure: 4.15 MPa ■ High pressure switch (S1PH) recovery pressure: 3.2 MPa
Supposed Causes	<ul style="list-style-type: none"> ■ Actuation of high pressure switch (S1PH) ■ Closed stop valve ■ Disconnection of connector X820A or S40 ■ Disconnection of 2 terminals of high pressure switch (S1PH) ■ Defective outdoor unit PCB ■ Broken S1PH harness ■ Defective high pressure switch (S1PH)

Troubleshooting



R6001170

9.8 OL Activation (Compressor Overload)

Error Code	E5
Outdoor Unit LED Display	A  1  2 ● 3  4 ● 5 ●
Method of Error Detection	A compressor overload is detected through compressor OL.
Error Decision Conditions	<ul style="list-style-type: none"> ■ If the error repeats, the system is shut down. ■ Reset condition: Continuous run for about 60 minutes without any other error
Supposed Causes	<ul style="list-style-type: none"> ■ Disconnection of discharge pipe thermistor ■ Defective discharge pipe thermistor ■ Disconnection of connector X820A or S40 ■ Disconnection of 2 terminals of OL (Q1M) ■ Defective OL (Q1M) ■ Broken OL harness ■ Defective electronic expansion valve or coil ■ Defective four way valve or coil ■ Defective outdoor unit PCB ■ Refrigerant shortage ■ Water mixed in refrigerant ■ Defective stop valve

Troubleshooting



Caution Be sure to turn off the power switch before connecting or disconnecting connectors, or parts may be damaged.

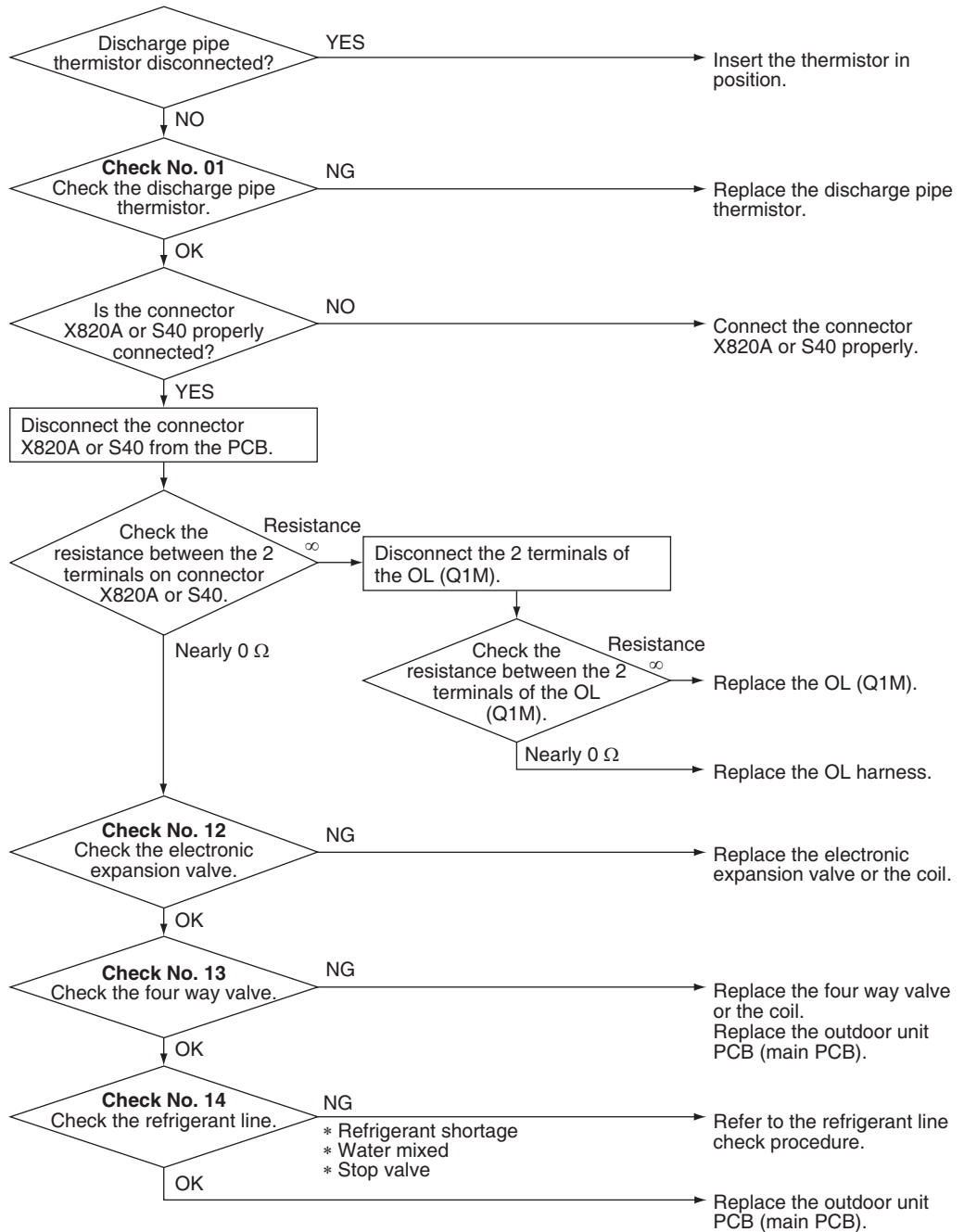

R6001171



Notes

OL (Q1M) activating temperature: 125°C (257°F)
 OL (Q1M) activating temperature: 110°C (230°F)



Reference

Check No.01 Refer to P.278



Reference

Check No.12 Refer to P.281



Reference







Check No.13 Refer to P.282



Reference

Check No.14 Refer to P.283

9.9 Compressor Lock

Error Code	E6
Outdoor Unit LED Display	A  1  2  3  4  5 
Method of Error Detection	A compressor lock is detected by checking the compressor running condition through the position detection circuit.
Error Decision Conditions	<ul style="list-style-type: none"> ■ Judging from the current waveform generated when high-frequency voltage is applied to the compressor. ■ If the error repeats, the system is shut down. ■ Reset condition: Continuous run for about 5 minutes without any other error
Supposed Causes	<ul style="list-style-type: none"> ■ Closed stop valve ■ Defective outdoor unit PCB ■ Defective compressor ■ Defective electronic expansion valve

Troubleshooting



Caution

Be sure to turn off the power switch before connecting or disconnecting connectors, or parts may be damaged.
 (Precaution before turning on the power again)
 Make sure the power has been off for at least 30 seconds.

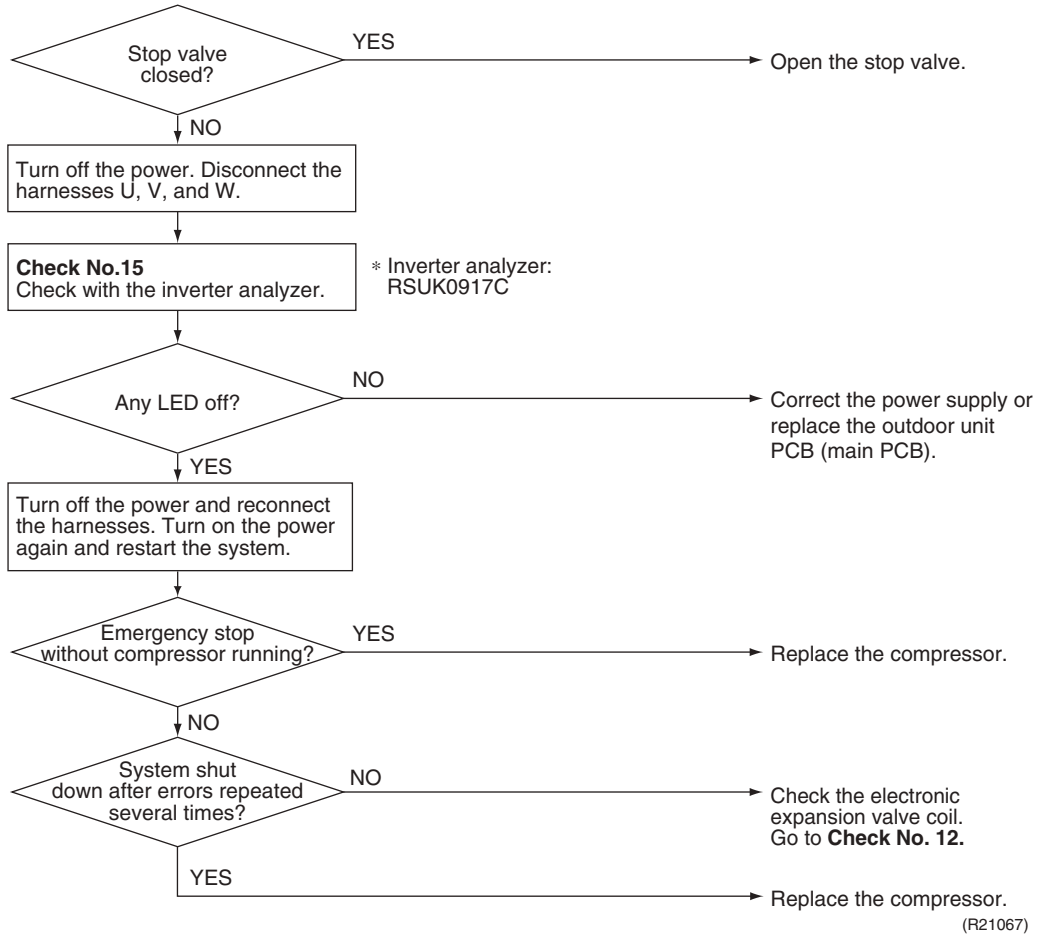

Reference





Check No.12 Refer to P.281



Reference

Check No.15 Refer to P.283

9.10 DC Fan Lock

Error Code	E7
Outdoor Unit LED Display	A  1  2  3  4  5 ●
Method of Error Detection	An error is determined when actual rotation speed per second (rps) is significantly apart from instructed rotation speed.
Error Decision Conditions	<ul style="list-style-type: none"> ■ The fan does not start in 30 seconds even when the fan motor is running. ■ If the error repeats, the system is shut down. ■ Reset condition: Continuous run for about 5 minutes without any other error
Supposed Causes	<ul style="list-style-type: none"> ■ Disconnection of the fan motor ■ Foreign matter stuck in the fan ■ Defective fan motor ■ Defective outdoor unit PCB

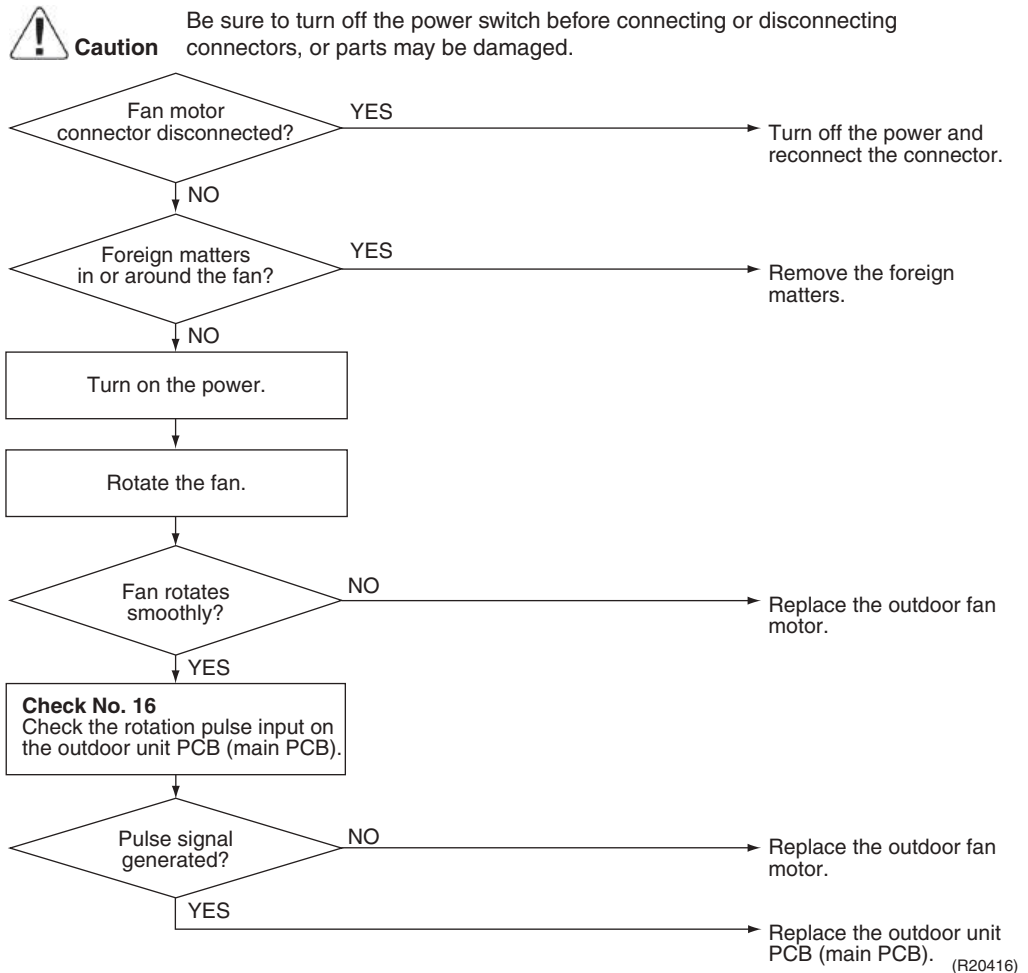

Troubleshooting



Reference

Check No.16 Refer to P.285

9.11 Input Overcurrent Detection

Error Code	E8
Outdoor Unit LED Display	A  1 ● 2  3 ● 4  5 ●
Method of Error Detection	Detected by checking the input current value
Error Decision Conditions	<ul style="list-style-type: none">■ The input current is at a certain value (depending on the condition) for 2.5 seconds.■ The compressor halts if the error occurs, and restarts automatically after 3-minute standby.
Supposed Causes	<ul style="list-style-type: none">■ Outdoor temperature is out of operation range.■ Defective compressor■ Defective power module■ Defective outdoor unit PCB■ Short circuit

Troubleshooting



Caution Be sure to turn off the power switch before connecting or disconnecting connectors, or parts may be damaged.

* An input overcurrent may result from wrong internal wiring. If the system is interrupted by an input overcurrent after the wires have been disconnected and reconnected for part replacement, check the wiring again.

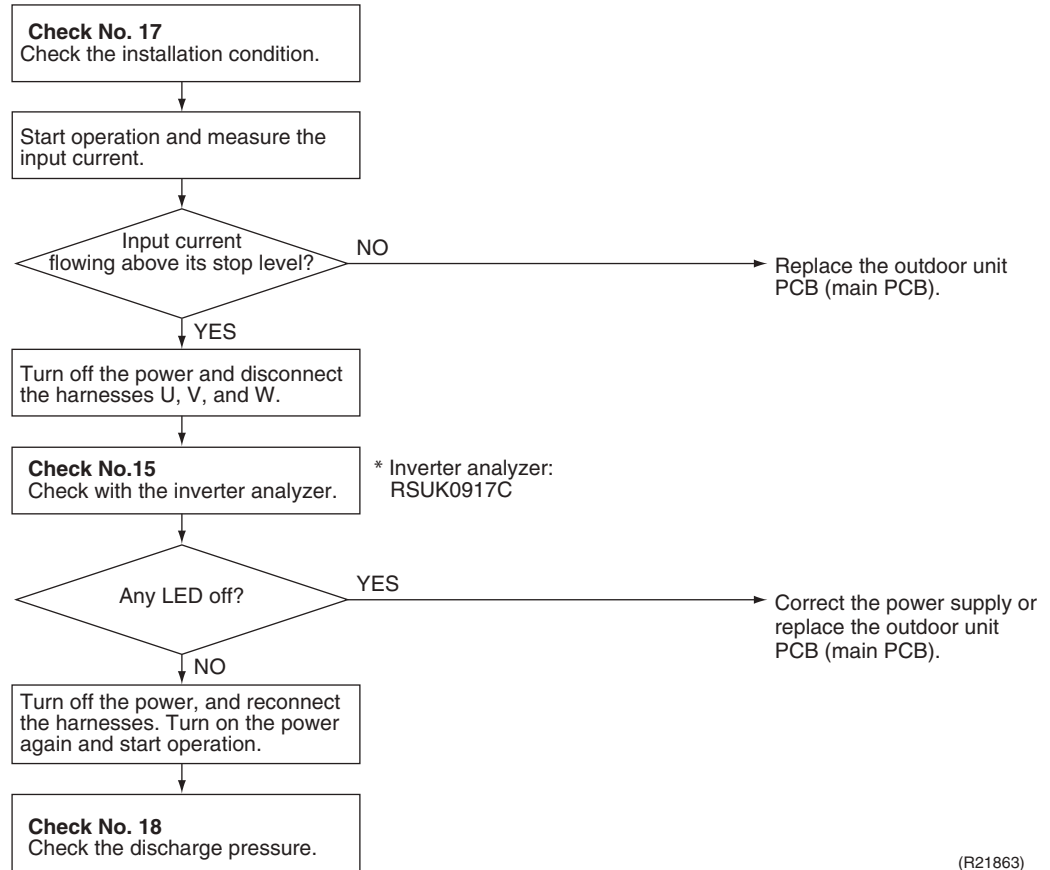

(R21863)



Reference Check No.15 Refer to P.283



Reference Check No.17 Refer to P.286



Reference Check No.18 Refer to P.286

9.12 Electronic Expansion Valve Coil Abnormality

Error Code	E9
Outdoor Unit LED Display	A 1 2 3 4 5
Method of Error Detection	Detect errors based on check of continuity of the electronic expansion valve.
Error Decision Conditions	<ul style="list-style-type: none"> ■ High input voltage from electronic expansion valve to the microcomputer due to overcurrent. ■ Low input voltage from electronic expansion valve to the microcomputer due to disconnected connectors.
Supposed Causes	<ul style="list-style-type: none"> ■ Defective electronic expansion coil ■ Broken harness of electronic expansion coil ■ Defective connection of electronic expansion coil connector ■ Defective outdoor unit main PCB

Troubleshooting

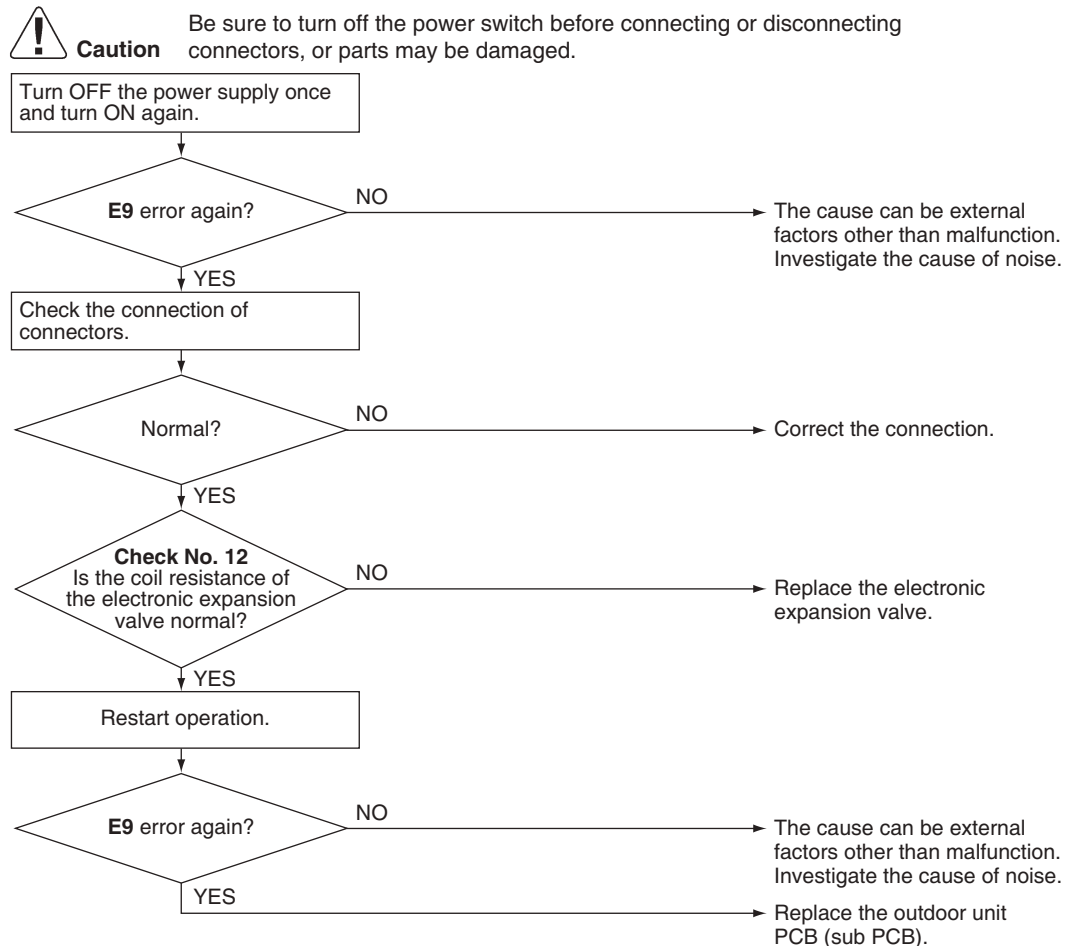



R6001181



Reference

Check No.12 Refer to P.281

9.13 Four Way Valve Abnormality

Error Code	EA		
Outdoor Unit LED Display	A  1  2 ● 3 ● 4 ● 5 ●		
Method of Error Detection	Detects whether the four-way valve is switching normally by the indoor heat exchanger temperature.		
Error Decision Conditions	<p>The following condition continues for A seconds after the compressor has started.</p> <ul style="list-style-type: none"> ■ Cooling operation The lowest indoor heat exchanger temperature > 45°C (113°F) ■ Heating operation The highest indoor heat exchanger temperature < 0°C (32°F) 		
			Tde: outdoor heat exchanger temperature
Supposed Causes	<ul style="list-style-type: none"> ■ Disconnection of four way valve coil ■ Defective four way valve, coil, or harness ■ Defective outdoor unit PCB ■ Defective thermistor ■ Refrigerant shortage ■ Water mixed in refrigerant ■ Defective stop valve 		

		2/3/4MXM 2MXT(H)	5MXM 3/4/5MXT(H)	
A (seconds)	Cooling	240	680	
	Heating	outdoor temperature ≥ -15°C (5°F)	240	680
		outdoor temperature < -15°C (5°F)	460	680

Troubleshooting



Caution Be sure to turn off the power switch before connecting or disconnecting connectors, or parts may be damaged.

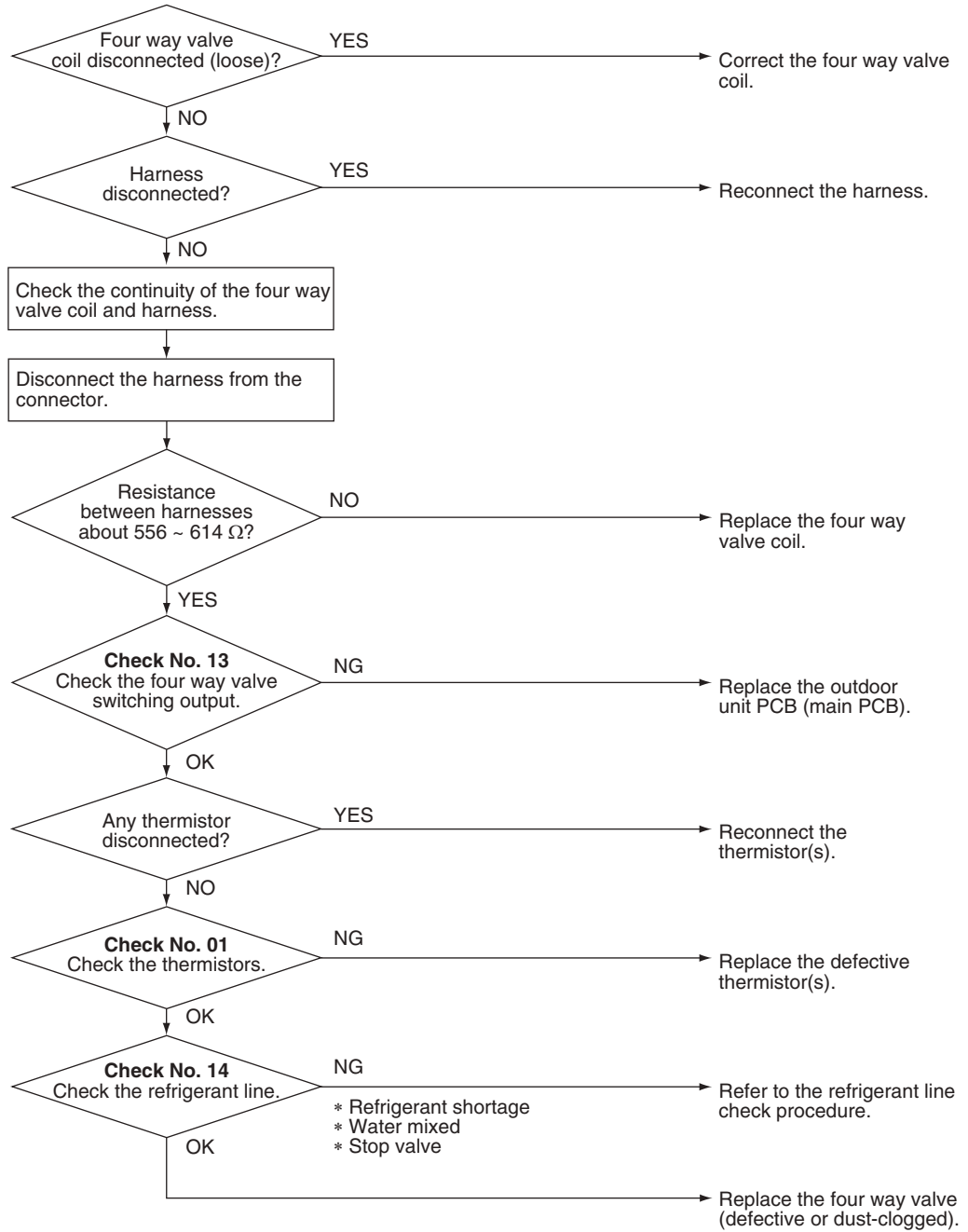

R6001164



Reference Check No.01 Refer to P.278



Reference Check No.13 Refer to P.282



Reference Check No.14 Refer to P.283

9.14 Discharge Pipe Temperature Control

Error Code	F3									
Outdoor Unit LED Display	A 1 2 3 4 5									
Method of Error Detection	An error is determined with the temperature detected by the discharge pipe thermistor.									
Error Decision Conditions	<ul style="list-style-type: none"> ■ If the temperature detected by the discharge pipe thermistor rises above A, the compressor stops. ■ The error is cleared when the discharge pipe temperature is dropped below B. ■ If the error repeats, the system is shut down. ■ Reset condition: Continuous run for about 60 minutes without any other error <table border="1"> <thead> <tr> <th></th> <th>°C</th> <th>°F</th> </tr> </thead> <tbody> <tr> <td>A</td> <td>120</td> <td>248</td> </tr> <tr> <td>B</td> <td>107</td> <td>224.6</td> </tr> </tbody> </table>		°C	°F	A	120	248	B	107	224.6
	°C	°F								
A	120	248								
B	107	224.6								
Supposed Causes	<ul style="list-style-type: none"> ■ Defective discharge pipe thermistor (Defective outdoor heat exchanger thermistor or outdoor temperature thermistor) ■ Defective electronic expansion valve or coil ■ Refrigerant shortage ■ Defective four way valve ■ Water mixed in refrigerant ■ Defective stop valve ■ Defective outdoor unit PCB 									

Troubleshooting

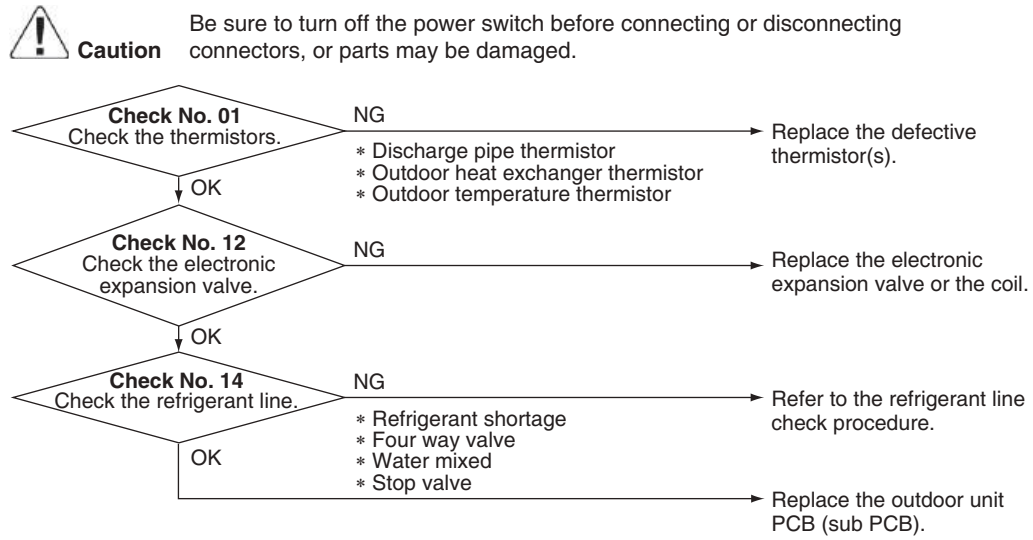

R6001193





- Reference** **Check No.01** Refer to P.278
- Reference** **Check No.12** Refer to P.281
- Reference** **Check No.14** Refer to P.283

9.15 High Pressure Control in Cooling

Error Code

F6

Outdoor Unit LED Display

A  1  2  3  4  5

Method of Error Detection

High pressure control (operation halt, compressor speed drop, etc.) is activated in cooling operation if the temperature sensed by the outdoor heat exchanger thermistor exceeds the limit.

Error Decision Conditions

- The temperature sensed by the outdoor heat exchanger thermistor rises above about **A**.
- The error is cleared when the temperature drops below about **B**.

	°C	°F
A	59	138.2
B	50	122



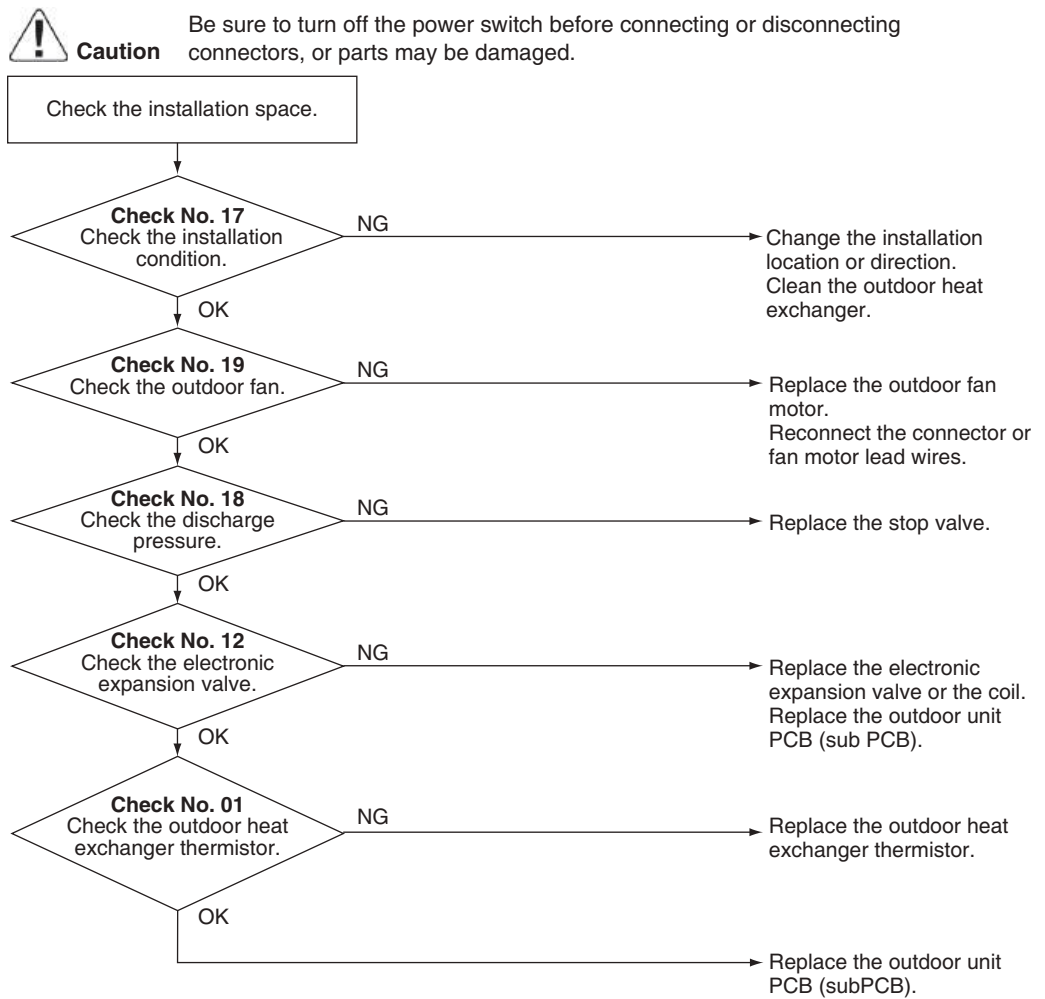

Supposed Causes

- The installation space not large enough
- Dirty outdoor heat exchanger
- Defective outdoor fan motor
- Defective stop valve
- Defective electronic expansion valve or coil
- Defective outdoor heat exchanger thermistor
- Defective outdoor unit PCB

Troubleshooting



R6001194

-  **Reference** **Check No.01** Refer to P.278
-  **Reference** **Check No.12** Refer to P.281
-  **Reference** **Check No.17** Refer to P.286
-  **Reference** **Check No.18** Refer to P.286
-  **Reference** **Check No.19** Refer to P.287

9.16 System Shutdown due to Temperature Abnormality in the Compressor

Error Code	F8
Outdoor Unit LED Display	A ● 1 ● 2 ● 3 ● 4 ● 5 ●
Method of Error Detection	Operation is halted when the temperature detected by the discharge pipe thermistor exceeds the determined limit.
Error Decision Conditions	Temperature exceeds the detection threshold of 127.5°C (261.5°F) during forced cooling operation.
Supposed Causes	<ul style="list-style-type: none"> ■ Abnormal operation due to air intrusion ■ Defective discharge pipe thermistor

Troubleshooting



Caution

Be sure to turn off the power switch before connecting or disconnecting connectors, or parts may be damaged.

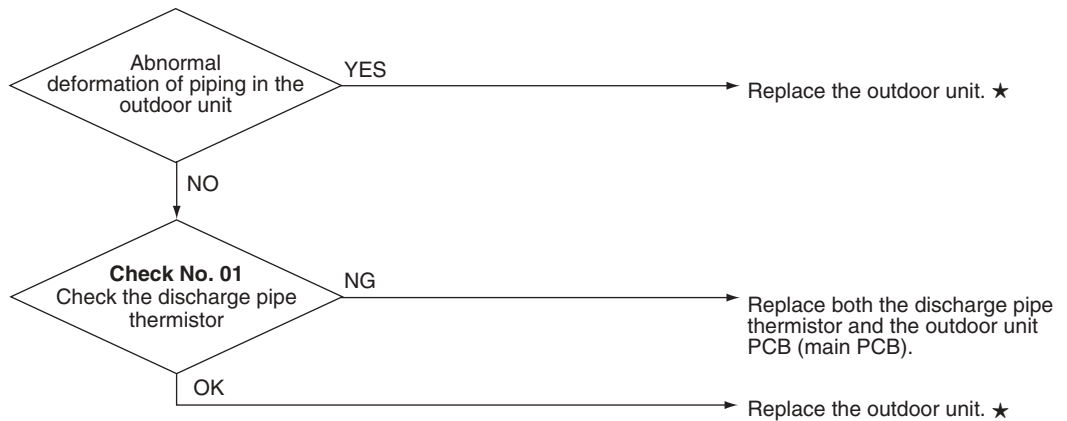

★ Replace the unit as directed in the installation manual, making sure that air does not intrude into the refrigerant piping.





(R23655)



Reference

Check No.01 Refer to P.278



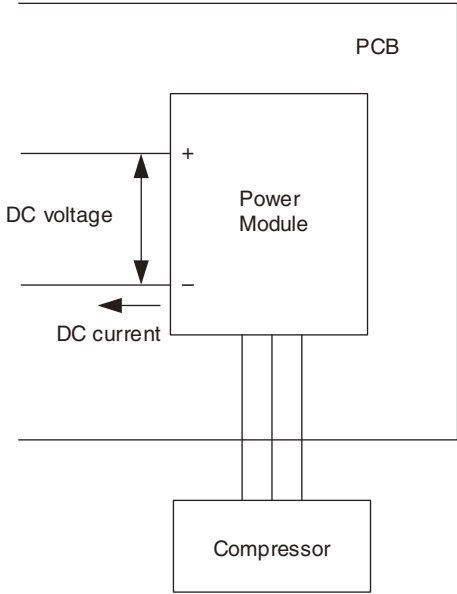

9.17 Compressor Sensor System Abnormality

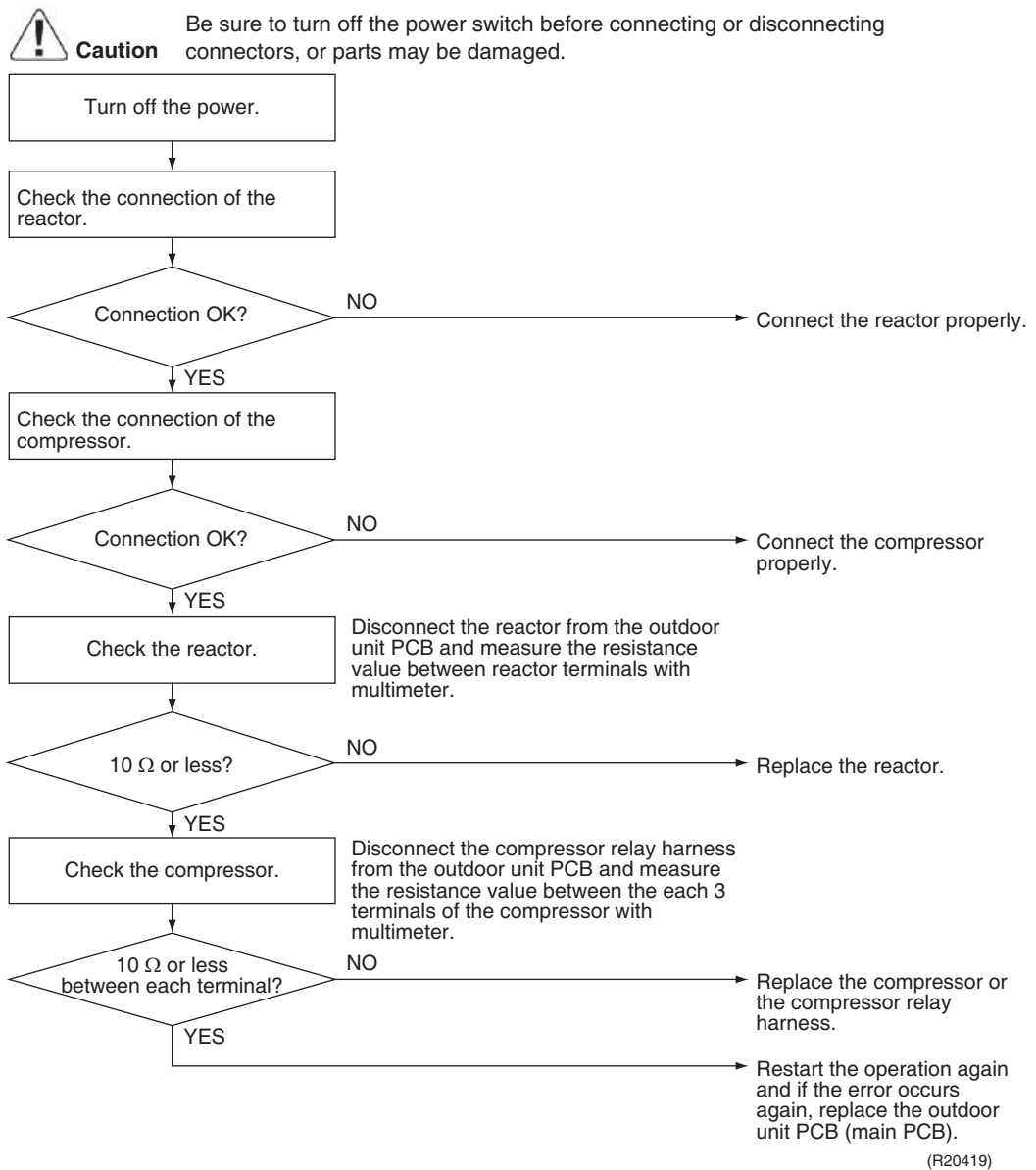
Error Code	H0
Outdoor Unit LED Display	A  1  2  3  4  5
Method of Error Detection	<ul style="list-style-type: none"> ■ The system checks the power supply voltage and the DC voltage before the compressor starts. ■ The system checks the DC current of the compressor right after the compressor starts.
	 <p style="text-align: right; margin-right: 50px;">(R22001)</p>
Error Decision Conditions	<ul style="list-style-type: none"> ■ The power supply voltage and the DC voltage is obviously low or high. ■ The DC current of the compressor does not flow when the compressor starts.
Supposed Causes	<ul style="list-style-type: none"> ■ Disconnection of reactor ■ Disconnection of compressor harness ■ Defective outdoor unit PCB ■ Defective compressor

Troubleshooting



9.18 High Pressure Switch System Abnormality

Error Code	H3
Outdoor Unit LED Display	A  1  2  3  4  5
Method of Error Detection	The protection device circuit checks continuity in the high pressure switch.
Error Decision Conditions	There is no continuity in the high pressure switch when the compressor stops operating.
Supposed Causes	<ul style="list-style-type: none"> ■ Defective high pressure switch ■ Defective connection of high pressure switch connector ■ Defective outdoor unit main PCB ■ Disconnected lead wire

Troubleshooting

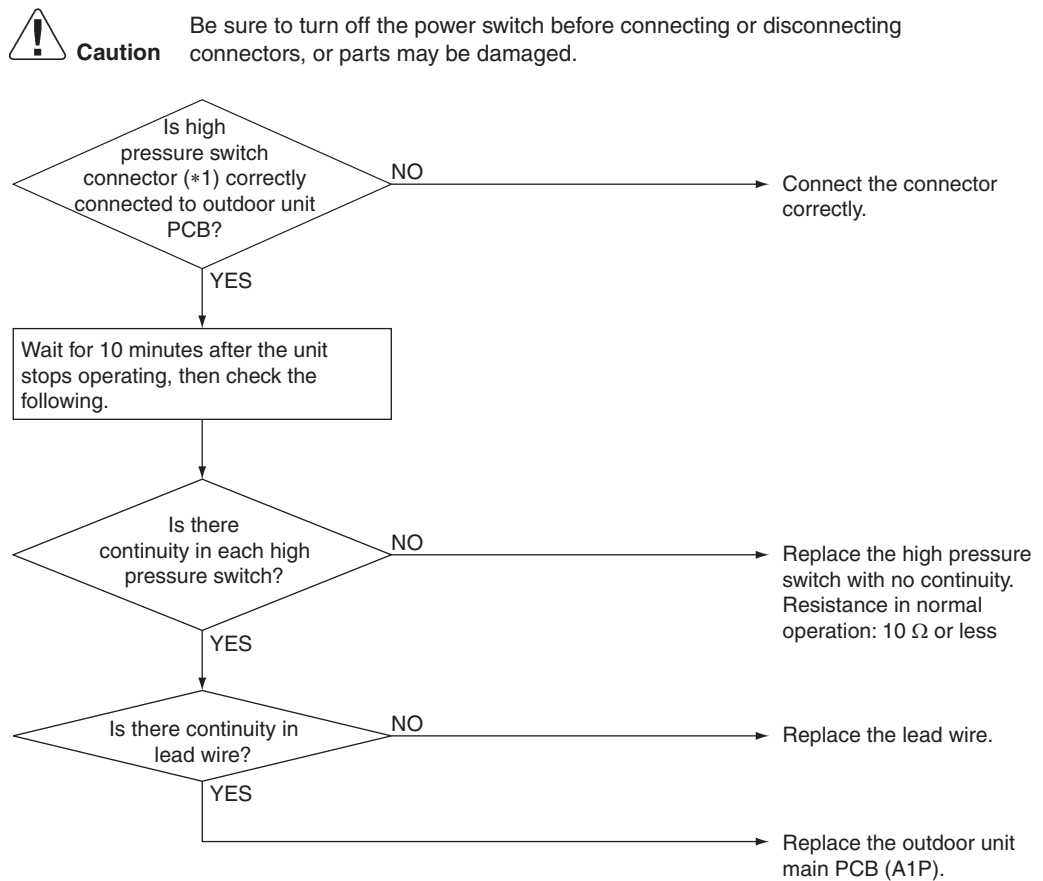

R6001112





Note(s)

*1. Connector and high pressure switch

High pressure switch	Connector for high pressure switch	Activation pressure
S1PH	X820A or S40	4.15 MPa

9.19 Position Sensor Abnormality

Error Code	H6
Outdoor Unit LED Display	A  1  2  3 ● 4 ● 5 ●
Method of Error Detection	A compressor start-up failure is detected by checking the compressor running condition through the position detection circuit.
Error Decision Conditions	<ul style="list-style-type: none"> ■ If the error repeats, the system is shut down. ■ Reset condition: Continuous run for about 5 minutes without any other error
Supposed Causes	<ul style="list-style-type: none"> ■ Power supply voltage out of specification ■ Disconnection of the compressor harness ■ Defective compressor ■ Defective outdoor unit PCB ■ Start-up failure caused by the closed stop valve ■ Input voltage outside the specified range



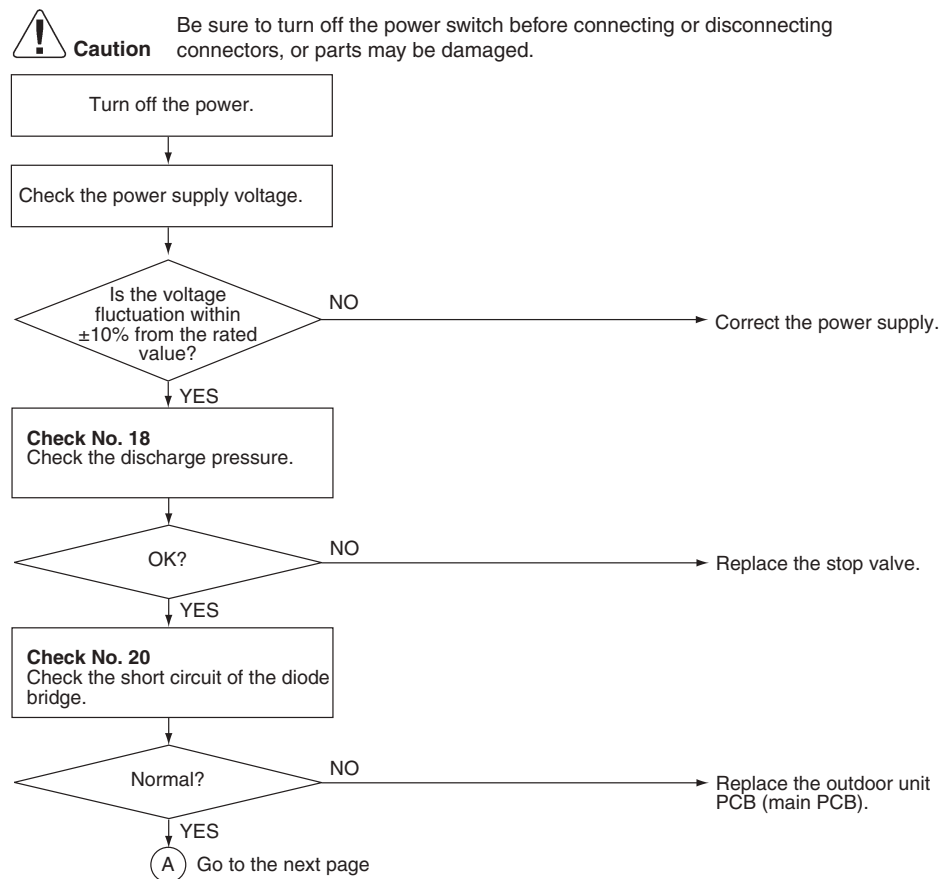

Troubleshooting

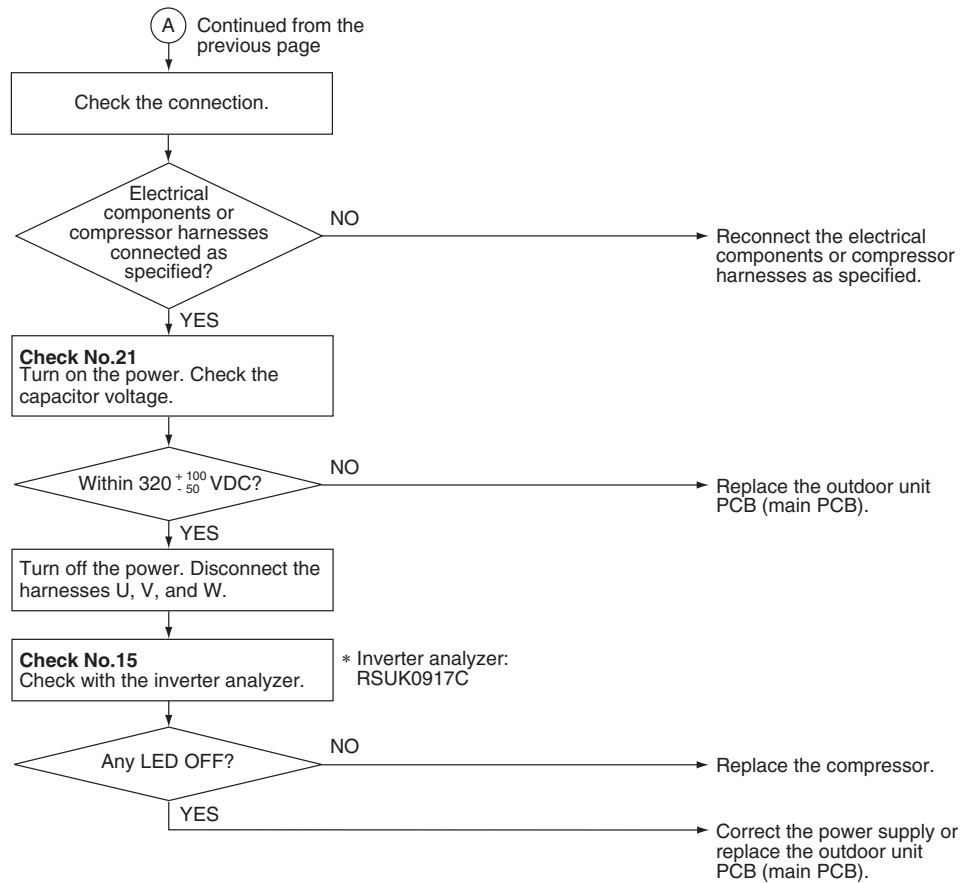





R6001174



R6001175

-  **Reference** **Check No.15** Refer to P.283
-  **Reference** **Check No.18** Refer to P.286
-  **Reference** **Check No.20** Refer to P.287
-  **Reference** **Check No.21** Refer to P.289

9.20 Thermistor or Related Abnormality (Outdoor Unit)

Error Code	H9, J3, J6, J8, J9, P4
Outdoor Unit LED Display	A  1  2  3 ● 4 ● 5 ●
Method of Error Detection	This fault is identified based on the thermistor input voltage to the microcomputer. A thermistor fault is identified based on the temperature sensed by each thermistor.
Error Decision Conditions	<ul style="list-style-type: none"> ■ The voltage between the both ends of the thermistor is above 4.96 V or below 0.04 V with the power on. ■ J3 error is judged if the discharge pipe temperature is lower than the heat exchanger temperature. ■ The system is shut down if all the units are judged as the J8 error.
Supposed Causes	<ul style="list-style-type: none"> ■ Disconnection of the connector for the thermistor ■ Defective thermistor(s) ■ Defective heat exchanger thermistor in the case of J3 error (outdoor heat exchanger thermistor in cooling operation, or indoor heat exchanger thermistor in heating operation) ■ Defective outdoor unit PCB
Troubleshooting	<p>In case of P4</p> <div style="display: flex; align-items: center;">  <div> <p>Caution Be sure to turn off the power switch before connecting or disconnecting connectors, or parts may be damaged.</p> </div> </div> <p>Replace the outdoor unit PCB (main PCB).</p> <p>P4 : Radiation fin thermistor</p>

Troubleshooting In case of H9, J3, J6, J8, J9

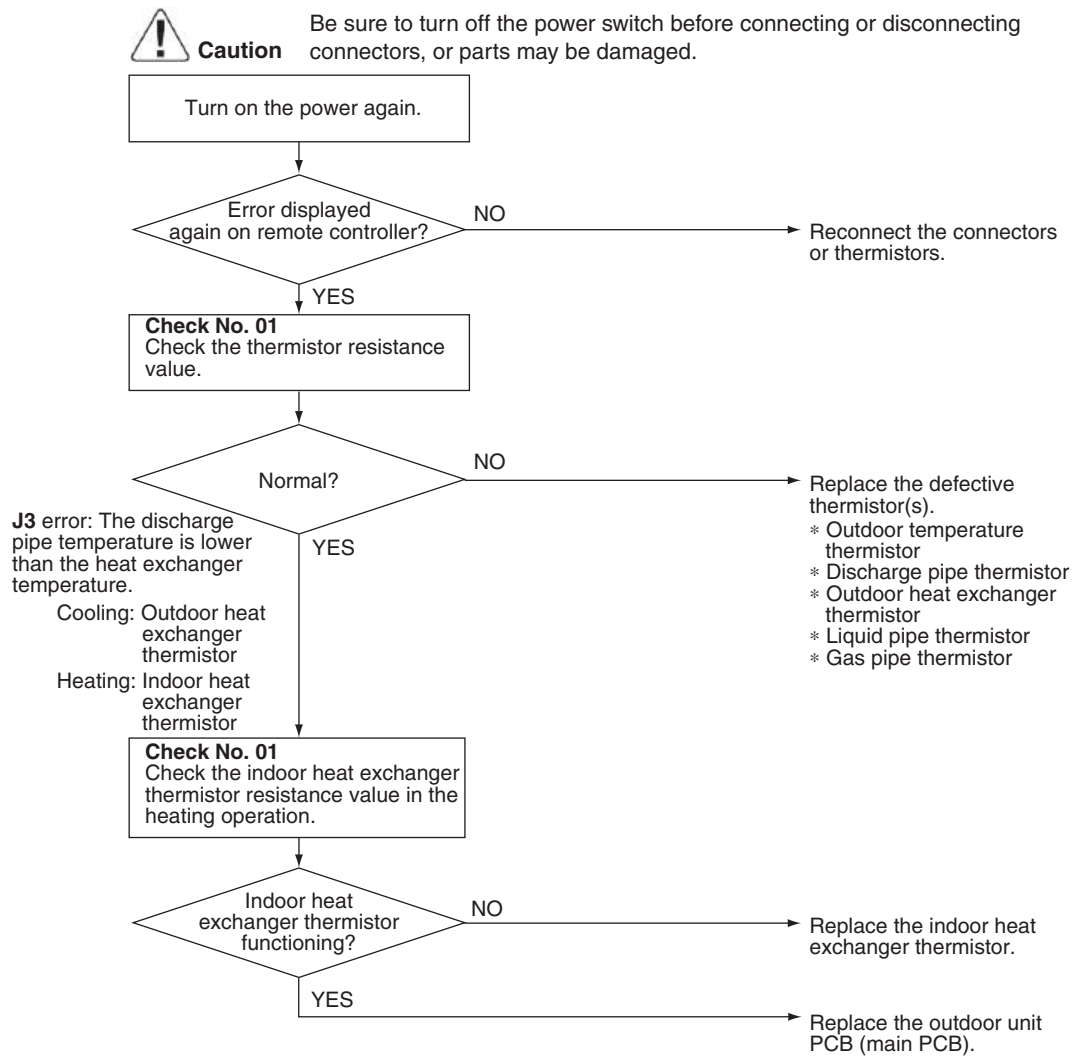

(R21118)

- H9** : Outdoor temperature thermistor
- J3** : Discharge pipe thermistor
- J6** : Outdoor heat exchanger thermistor
- J8** : Liquid pipe thermistor
- J9** : Gas pipe thermistor



Reference

Check No.01 Refer to P.278

9.21 High Pressure Sensor Abnormality

Applicable Models	5MXM48AVJU9(8) 3MXT(H)24AVJU9(8), 4MXT(H)36AVJU9(8), 5MXT(H)40AVJU9(8)
Error Code	JA
Outdoor Unit LED Display	A 1 2 3 4 5 ●
Method of Error Detection	Error is detected from the pressure detected by the high pressure sensor.
Error Decision Conditions	The high pressure sensor is short circuited or open circuited. Pressure range: 0 - 4.17 MPa
Supposed Causes	<ul style="list-style-type: none"> ■ Defective high pressure sensor ■ Connection of low pressure sensor with wrong connection ■ Defective outdoor unit PCB ■ Disconnection of high pressure sensor

Troubleshooting

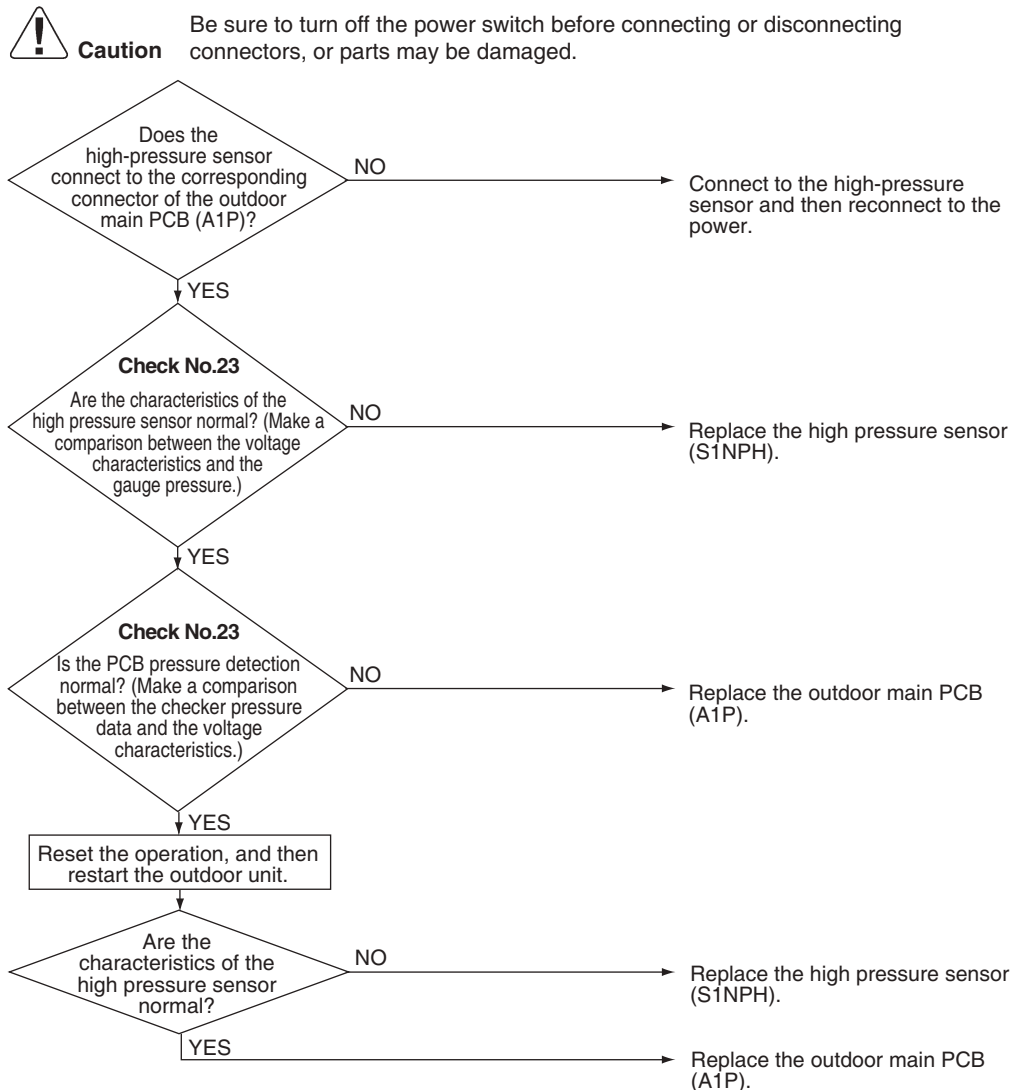





R6001351



Reference **Check No.23** Refer to P.292

9.22 Electrical Box Temperature Rise

Error Code	L3																														
Outdoor Unit LED Display	A  1  2  3 ● 4  5 ●																														
Method of Error Detection	An electrical box temperature rise is detected by checking the radiation fin thermistor with the compressor off.																														
Error Decision Conditions	<ul style="list-style-type: none"> ■ With the compressor off, the radiation fin temperature is above A. ■ The error is cleared when the temperature drops below B. ■ To cool the electrical components, the outdoor fan starts when the radiation fin temperature rises above C and stops when the radiation fin temperature drops below B. <p>2/3/4MXM, 2MXT(H)</p> <table border="1" style="width: 100%; border-collapse: collapse;"> <thead> <tr> <th></th> <th>°C</th> <th>°F</th> </tr> </thead> <tbody> <tr> <td>A</td> <td>100</td> <td>212</td> </tr> <tr> <td>B</td> <td>70</td> <td>158</td> </tr> <tr> <td>C</td> <td>85</td> <td>185</td> </tr> </tbody> </table> <p>5MXM, 3/4/5MXT(H) Normal operation</p> <table border="1" style="width: 100%; border-collapse: collapse;"> <thead> <tr> <th></th> <th>°C</th> <th>°F</th> </tr> </thead> <tbody> <tr> <td>A</td> <td>70</td> <td>158</td> </tr> <tr> <td>B</td> <td>60</td> <td>140</td> </tr> </tbody> </table> <p>After completion of forced cooling operation until next compressor startup</p> <table border="1" style="width: 100%; border-collapse: collapse;"> <thead> <tr> <th></th> <th>°C</th> <th>°F</th> </tr> </thead> <tbody> <tr> <td>A</td> <td>74</td> <td>165.2</td> </tr> <tr> <td>B</td> <td>60</td> <td>140</td> </tr> </tbody> </table>		°C	°F	A	100	212	B	70	158	C	85	185		°C	°F	A	70	158	B	60	140		°C	°F	A	74	165.2	B	60	140
	°C	°F																													
A	100	212																													
B	70	158																													
C	85	185																													
	°C	°F																													
A	70	158																													
B	60	140																													
	°C	°F																													
A	74	165.2																													
B	60	140																													
Supposed Causes	<ul style="list-style-type: none"> ■ Defective outdoor fan motor ■ Short circuit ■ Defective radiation fin thermistor ■ Disconnection of connector ■ Defective outdoor unit PCB 																														

Troubleshooting



Caution

Be sure to turn off the power switch before connecting or disconnecting connectors, or parts may be damaged.

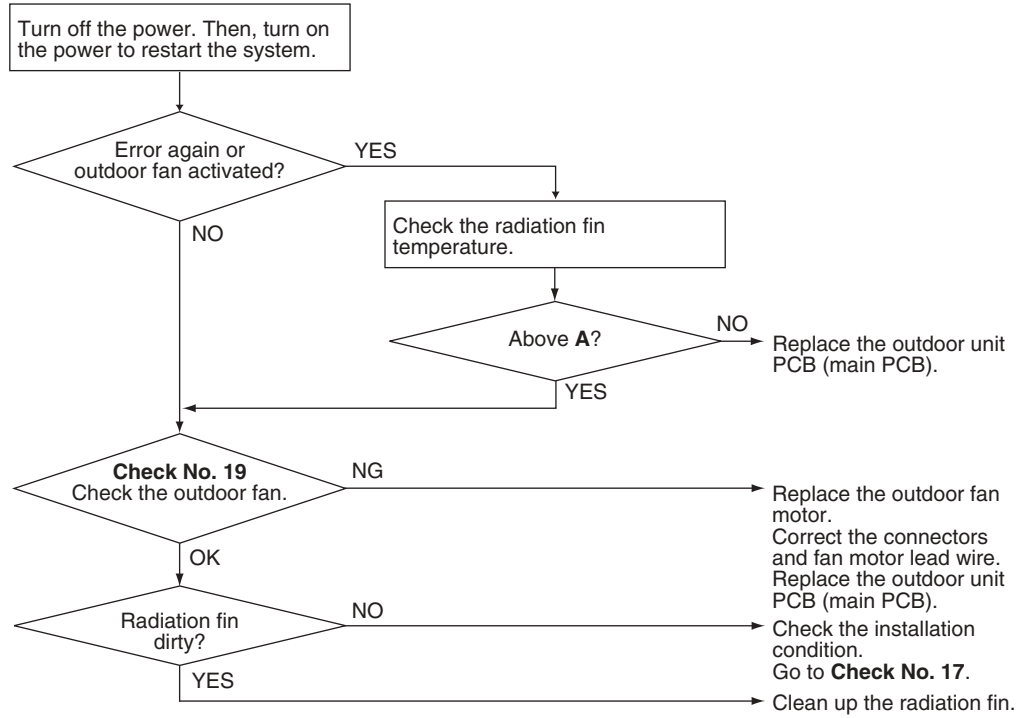

R6000426





Reference Check No.17 Refer to P.286



Reference Check No.19 Refer to P.287

9.23 Radiation Fin Temperature Rise

Error Code	L4																											
Outdoor Unit LED Display	A  1 ● 2 ● 3 ● 4  5 ●																											
Method of Error Detection	A radiation fin temperature rise is detected by checking the radiation fin temperature with the compressor on.																											
Error Decision Conditions	<ul style="list-style-type: none"> ■ The radiation fin temperature with the compressor on is above A. ■ The error is cleared when the temperature drops below B. ■ If the error repeats, the system is shut down. ■ Reset condition: Continuous run for about 60 minutes without any other error <p>2/3/4MXM, 2MXT(H)</p> <table border="1" style="width: 100%; border-collapse: collapse;"> <thead> <tr> <th></th> <th>°C</th> <th>°F</th> </tr> </thead> <tbody> <tr> <td>A</td> <td>95</td> <td>203</td> </tr> <tr> <td>B</td> <td>85</td> <td>185</td> </tr> </tbody> </table> <p>5MXM, 3/4/5MXT(H)</p> <p>Normal operation</p> <table border="1" style="width: 100%; border-collapse: collapse;"> <thead> <tr> <th></th> <th>°C</th> <th>°F</th> </tr> </thead> <tbody> <tr> <td>A</td> <td>70</td> <td>158</td> </tr> <tr> <td>B</td> <td>64</td> <td>147.2</td> </tr> </tbody> </table> <p>In forced cooling operation</p> <table border="1" style="width: 100%; border-collapse: collapse;"> <thead> <tr> <th></th> <th>°C</th> <th>°F</th> </tr> </thead> <tbody> <tr> <td>A</td> <td>74</td> <td>165.2</td> </tr> <tr> <td>B</td> <td>64</td> <td>147.2</td> </tr> </tbody> </table>		°C	°F	A	95	203	B	85	185		°C	°F	A	70	158	B	64	147.2		°C	°F	A	74	165.2	B	64	147.2
	°C	°F																										
A	95	203																										
B	85	185																										
	°C	°F																										
A	70	158																										
B	64	147.2																										
	°C	°F																										
A	74	165.2																										
B	64	147.2																										
Supposed Causes	<ul style="list-style-type: none"> ■ Defective outdoor fan motor ■ Short circuit ■ Disconnection of connector ■ Defective outdoor unit PCB ■ Silicone grease not applied properly on the radiation fin after replacing the outdoor unit PCB 																											

Troubleshooting



Caution

Be sure to turn off the power switch before connecting or disconnecting connectors, or parts may be damaged.

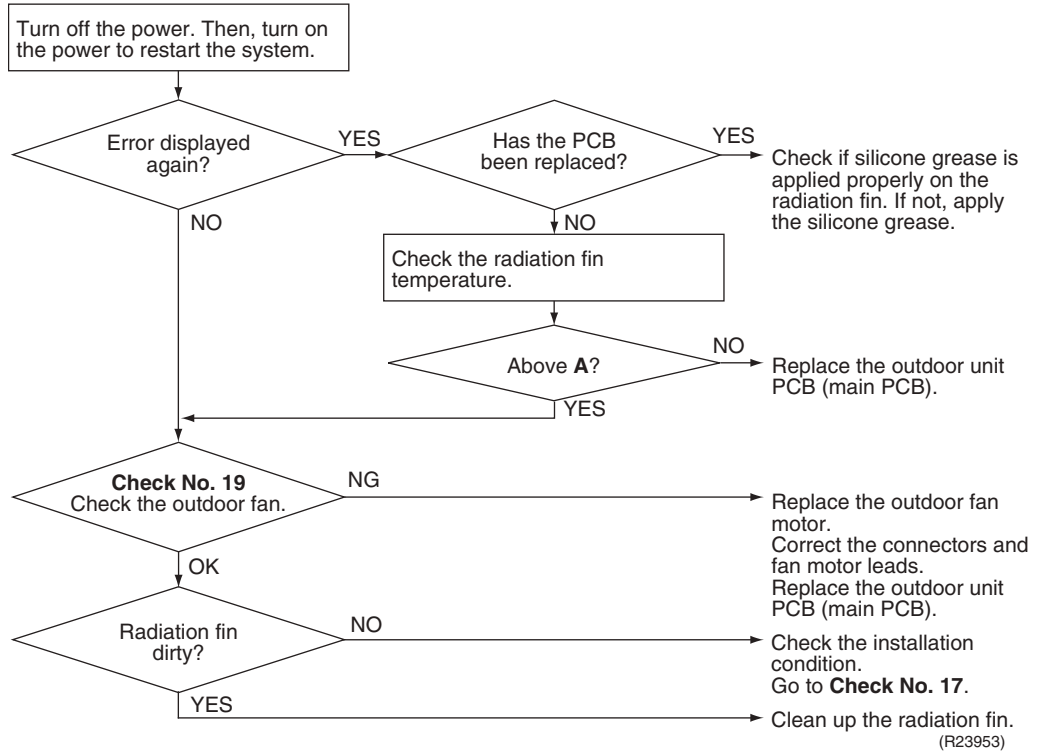

Note

Refer to Silicone Grease on Power Transistor/Diode Bridge on page 335 for details.



Reference



Check No.17 Refer to P.286



Reference

Check No.19 Refer to P.287

9.24 Output Overcurrent Detection

Error Code	L5
Outdoor Unit LED Display	A  1 ● 2 ● 3  4 ● 5 ●
Method of Error Detection	An output overcurrent is detected by checking the current that flows in the inverter DC section.
Error Decision Conditions	<ul style="list-style-type: none"> ■ A position signal error occurs while the compressor is running. ■ A rotation speed error occurs while the compressor is running. ■ An output overcurrent signal is fed from the output overcurrent detection circuit to the microcomputer. ■ If the error repeats, the system is shut down. ■ Reset condition: Continuous run for about 5 minutes without any other error
Supposed Causes	<ul style="list-style-type: none"> ■ Poor installation condition ■ Closed stop valve ■ Defective power module ■ Wrong internal wiring ■ Abnormal power supply voltage ■ Defective outdoor unit PCB ■ Supply voltage out of specification ■ Defective compressor

Troubleshooting





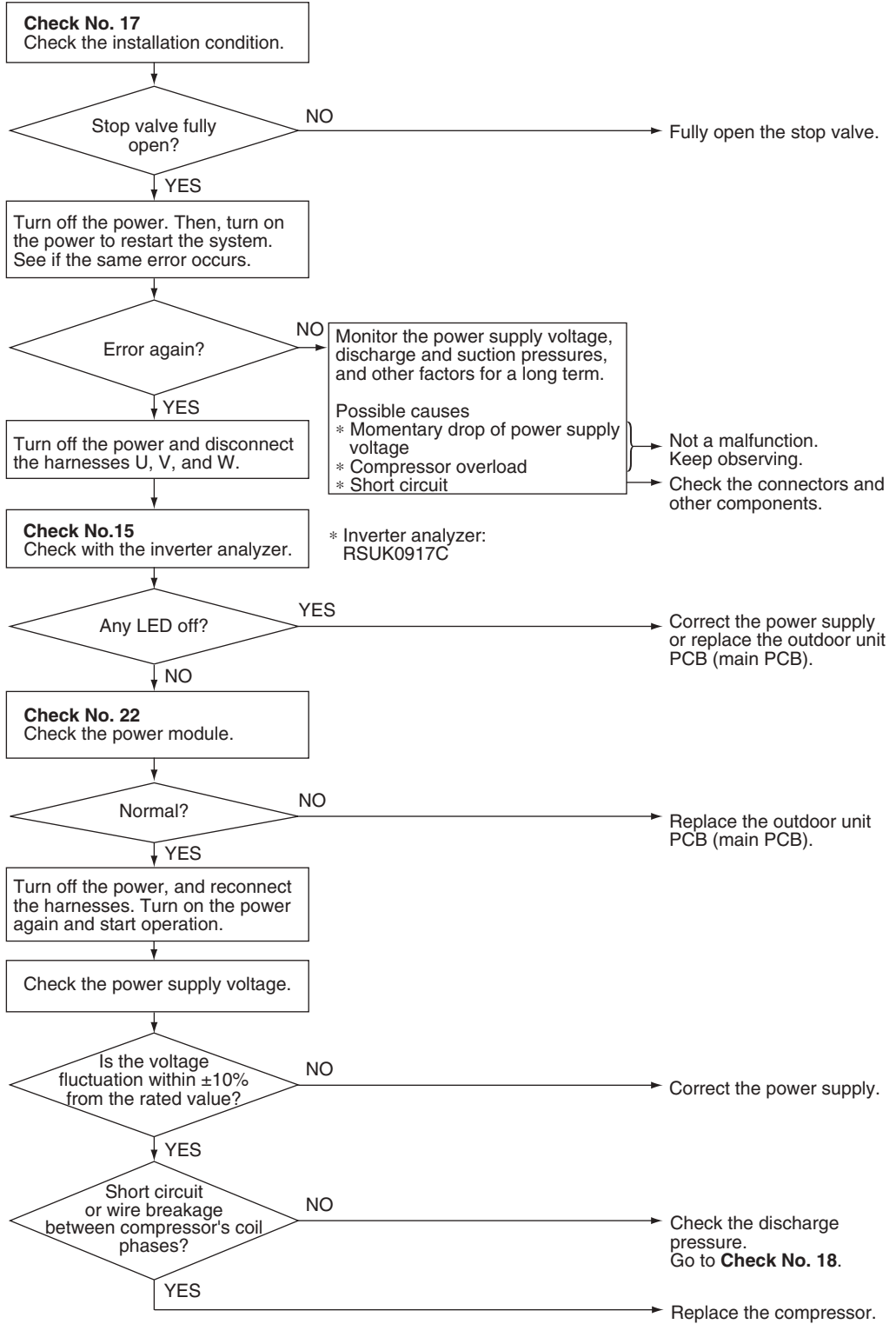

Caution Be sure to turn off the power switch before connecting or disconnecting connectors, or parts may be damaged.

* An output overcurrent may result from wrong internal wiring. If the system is interrupted by an output overcurrent after the wires have been disconnected and reconnected for part replacement, check the wiring again.



(R22566)

-  **Reference** **Check No.15** Refer to P.283
-  **Reference** **Check No.17** Refer to P.286
-  **Reference** **Check No.18** Refer to P.286
-  **Reference** **Check No.22** Refer to P.290

10.Check

10.1 Thermistor Resistance Check

Check No.01

Measure the resistance of each thermistor using multimeter.

The resistance values are defined by below table.

If the measured resistance value does not match the listed value, the thermistor must be replaced.

- Disconnect the connector of thermistor ASSY from the PCB to measure the resistance between the pins using multimeter.
- To check the thermistor soldered on a PCB, disconnect the PCB from other PCB/parts, and measure the resistance between the both ends of soldered thermistor.

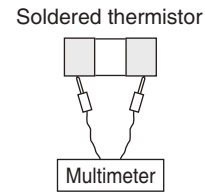
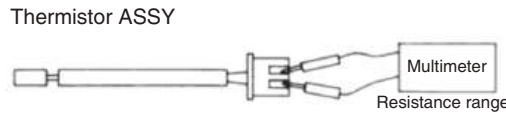

Thermistor temperature		Resistance (kΩ)
°C	°F	R(25°C / 77°F) = 20 kΩ B = 3950 K
-20	-4	197.8
-15	5	148.2
-10	14	112.1
-5	23	85.60
0	32	65.93
5	41	51.14
10	50	39.99
15	59	31.52
20	68	25.02
25	77	20.00
30	86	16.10
35	95	13.04
40	104	10.62
45	113	8.707
50	122	7.176

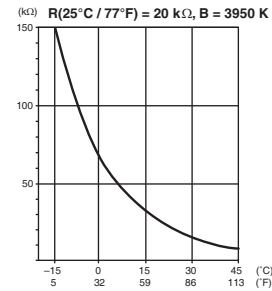

■ CMXV Thermistor

R6001195

Thermistor temperature		Resistance (kΩ)
°C	°F	R(25°C / 77°F) = 20 kΩ B = 3950 K
-20	-4	197.81
-15	5	148.10
-10	14	111.99
-5	23	85.49
0	32	65.84
5	41	51.09
10	50	39.96
15	59	31.50
20	68	25.01
25	77	20.00
30	86	16.10
35	95	13.04
40	104	10.63
45	113	8.71
50	122	7.18

i Notes

- When replacing the defective thermistor(s), replace the thermistor as ASSY.
- Thermistors of some models are fixed to piping with a thermal insulation tube and clamp as in the figure. After thermistors are removed, attach them in the original position with caution not to contact the surrounding objects.

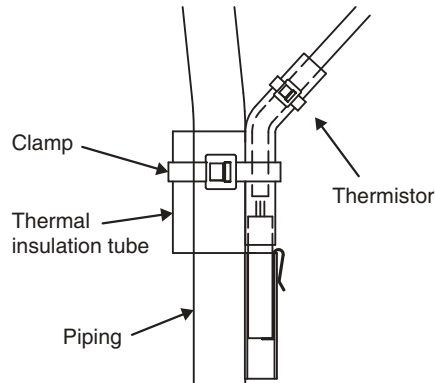

10.2 Indoor Fan Motor Connector Check

Check No.02

CDMA, FDMA Series

1. Turn the power supply OFF.
2. With the fan motor connector disconnected, measure the resistance between each pin, then make sure that the resistance is more than the value mentioned in the following table.

Measuring points	Judgement
White - Blue	1 MΩ or more
Orange - Blue	100 kΩ or more
Brown - Blue	100 Ω or more
Red - Blue	100 kΩ or more

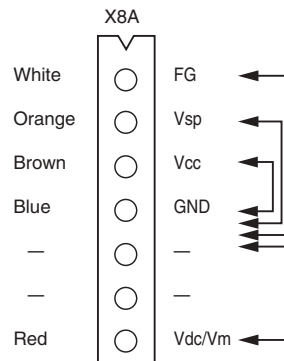

(R25080)

Check No.03

CTXV, FTXV Series

- Check the connection of connector.
- 1. Check connector the for connection.
- 2. Turn the power off.
- 3. Check if each resistance at the phases U - V and V - W is within specified rage in the table below.

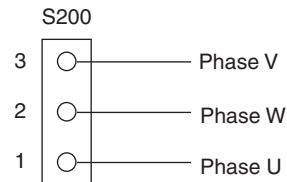

R6001148

	U - V/V - W Resistance (Ω)
07/09/12 class	70.9 ~ 78.3
15/18/24 class	42.9 ~ 47.5

FVXV Series

- Fan motor wire breakdown/short circuit check
- 1. Check the connector for connection.
- 2. Turn the power off.
- 3. Check if each resistance at the phases U - V, V - W, and W - U is within specified range in the table below.

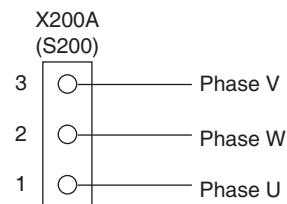

R6000972

	U - V/V - W Resistance (Ω)
09/12/15 class	85.0 ~ 98.0
18 class	27.0 ~ 33.0

10.3 Power Supply Waveform Check

Check No.11

Measure the power supply waveform between No. 1 and No. 2 on the terminal strip, and check the waveform disturbance.

- Check if the power supply waveform is a sine wave (Fig.1).
- Check if there is waveform disturbance near the zero-cross (sections circled in Fig.2).

[Fig.1]

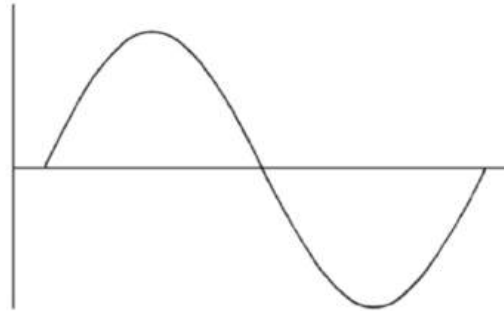

(R1736)

[Fig.2]

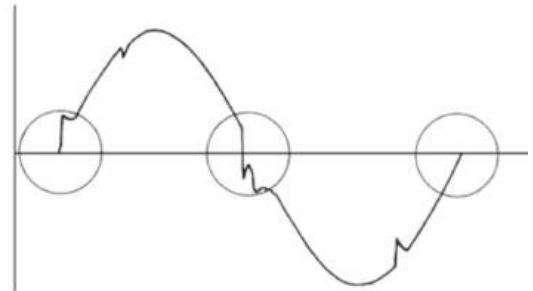

(R1444)

10.4 Electronic Expansion Valve Check

Check No.12

Conduct the followings to check the electronic expansion valve (EV).

1. Check if the EV connector is correctly inserted in the PCB. Match the EV unit number and the connector number.
2. Turn the power off and on again, and check if all the EVs generate latching sound.
3. If any of the EVs does not generate latching sound in the above step 2, disconnect that connector and check the continuity using a multimeter.
Check the continuity between the pins 5 - 1, 5 - 2, 5 - 3, 5 - 4. If there is no continuity between the pins, the EV coil is faulty.
4. If no EV generates a latching sound in the above step 2, the outdoor unit PCB is faulty.
5. If the continuity is confirmed in the above step 3, mount a good coil (which generated latching sound) in the EV unit that did not generate a latching sound, and check if that EV generates a latching sound.
* If a latching sound is generated, the outdoor unit PCB is faulty.
* If a latching sound is not generated, the EV unit is faulty.

If the system keeps operating with a defective electronic expansion valve, the following problem may occur.

Valve opening position	Possible problem	Check method
Open	Cooling: <ul style="list-style-type: none"> ■ Flowing noise of refrigerant in the unit which is not in operation ■ Water leakage at the unit which is not in operation ■ Operation half due to anti-icing function 	Reset power supply and conduct cooling operation unit by unit. Check the liquid pipe temperature of no-operation unit.
	Heating: <ul style="list-style-type: none"> ■ Flowing noise of refrigerant in the unit which is not in operation ■ The unit does not heat the room. 	

(R16019)

Valve opening position	Possible problem	Check method
Close	Cooling: ■ The problem unit does not cool the room. ■ Only the problem unit is in operation, the unit starts pump down. (The low pressure of the unit becomes vacuum.) ■ Abnormal discharge pipe temperature	Reset power supply and conduct cooling operation unit by unit. Check the low pressure. Does the pressure become into vacuum zone? NO → The EV is not defective. YES → Replace the EV of the room. (R16020)
	Heating: ■ Refrigerant shortage due to stagnation of liquid refrigerant inside the faulty indoor unit ■ The unit does not heat the room. ■ Abnormal discharge pipe temperature	

10.5 Four Way Valve Performance Check

Check No.13

< Caution on resetting the power supply >

* Be sure to wait for 30 sec. or more after turning off the power.

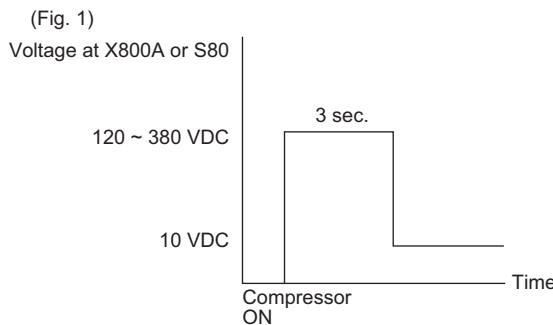
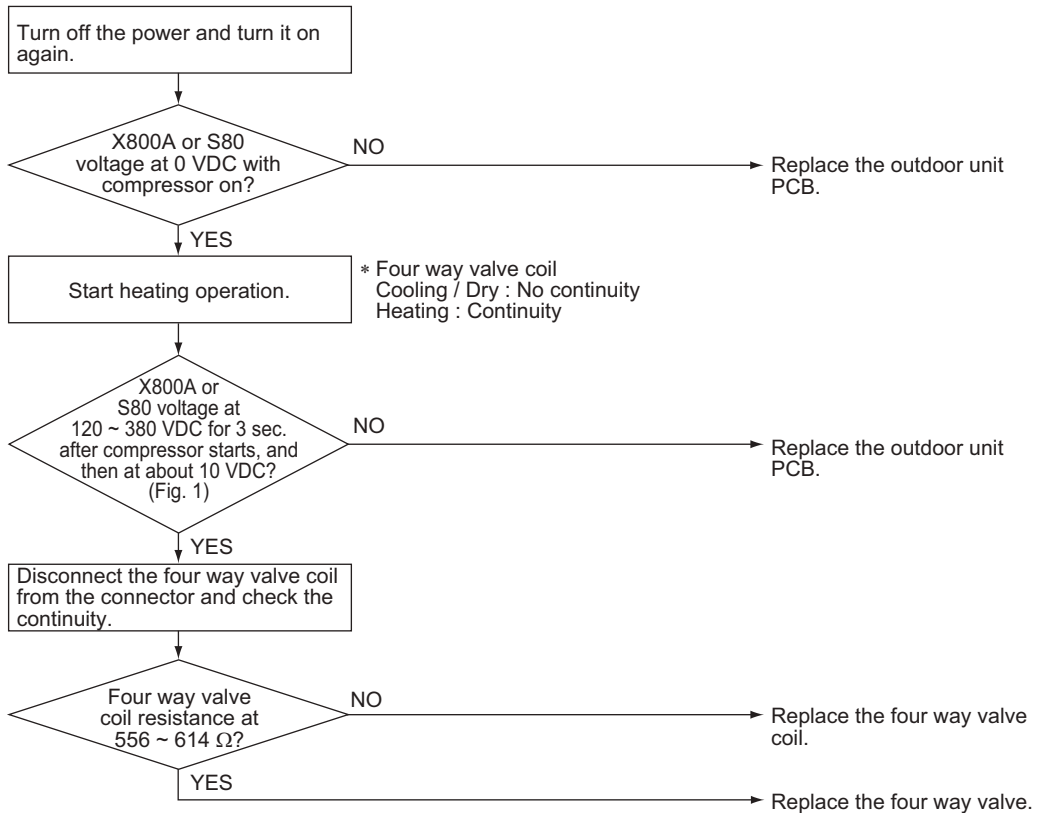

R6001165

10.6 Inverter Unit Refrigerant System Check

Check No.14

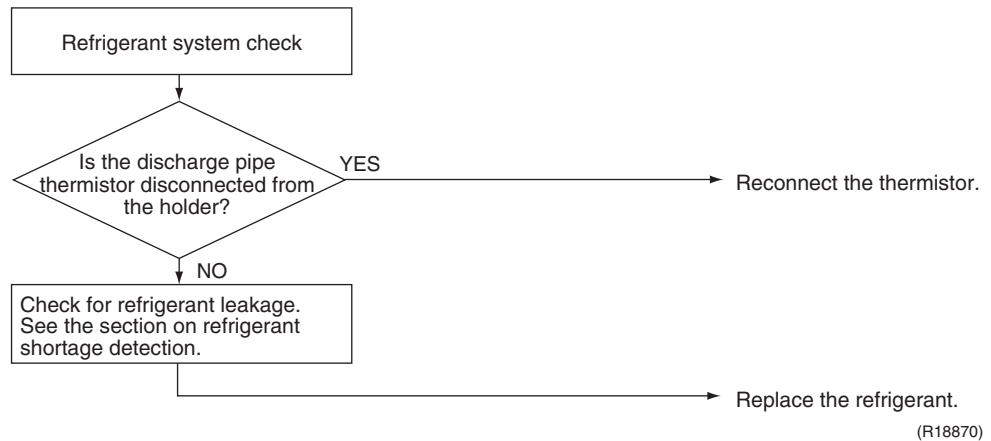

10.7 Inverter Analyzer Check

Check No.15

■ Characteristics

Inverter analyzer: RSUK0917C

If an abnormal stop occurs due to compressor startup failure or overcurrent output when using an inverter unit, it is difficult to judge whether the stop is caused by the compressor failure or some other failure (main PCB, power module, etc.). The inverter analyzer makes it possible to judge the cause of trouble easily and securely. Connect an inverter analyzer as a quasi-compressor instead of compressor and check the output of the inverter.

■ Operation Method

Step 1

Be sure to turn the power off.

Step 2

Install an inverter analyzer instead of a compressor.

Note:

Make sure the charged voltage of the built-in smoothing electrolytic capacitor drops to 10 VDC or below before carrying out the service work.

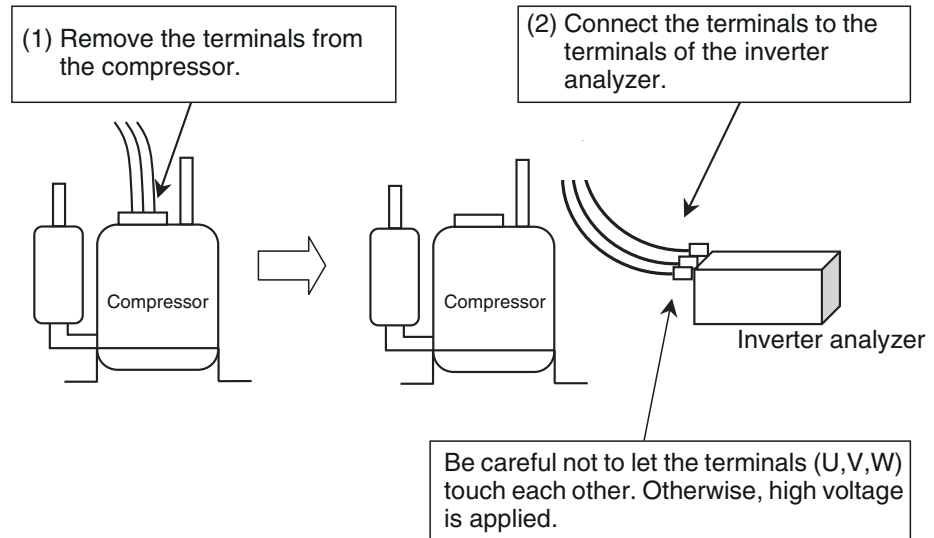

(R22731)

Reference:

If the terminals of the compressor are not FASTON terminals (difficult to remove the wire on the terminals), it is possible to connect wires available on site to the outdoor unit from output side of PCB. Do not connect them to the compressor at the same time, otherwise it may result in incorrect detection.

Step 3

Activate the power transistor test operation from the outdoor unit.
 Press the forced cooling operation **ON/OFF** switch for 5 seconds.
 (Refer to page 301 for the position.)
 → Power transistor test operation starts.

■ **Diagnose method (Diagnose according to 6 LEDs lighting status.)**

1. If all the LEDs are lit uniformly, the compressor is defective.
 → Replace the compressor.
2. If the LEDs are not lit uniformly, check the power module.
 → Refer to **Check No.22**.
3. If NG in **Check No.22**, replace the power module.
 (Replace the main PCB. The power module (IPM1) is united with the main PCB.)
 If OK in **Check No.22**, check if there is any solder cracking on the PCB.
4. If any solder cracking is found, replace the PCB or repair the soldered section.
 If there is no solder cracking, replace the PCB.



1. When the output compressor speed is low, the LEDs blink slowly. As the output compressor speed increases, the LEDs blink quicker. (The LEDs look like they are lit.)
2. On completion of the inverter analyzer diagnosis, be sure to re-crimp the FASTON terminals. Otherwise, the terminals may be burned due to loosening.

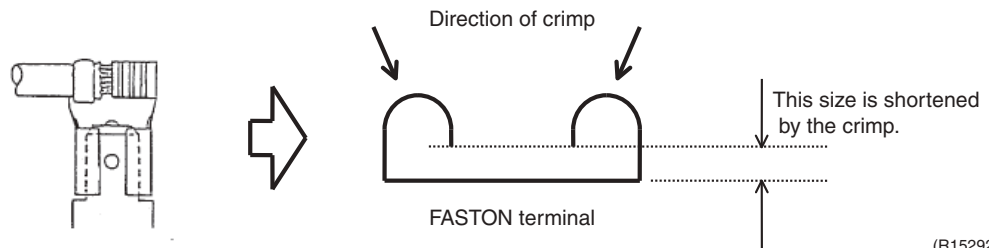

(R15292)

10.8 Outdoor Fan Motor Check

Check No.16

Outdoor fan motor

■ 2/3/4MXM, 2MXT(H)

Check if the sinusoidal voltage is generated between pins 1 - 3 and 3 - 5 when the fan motor is manually rotated once.

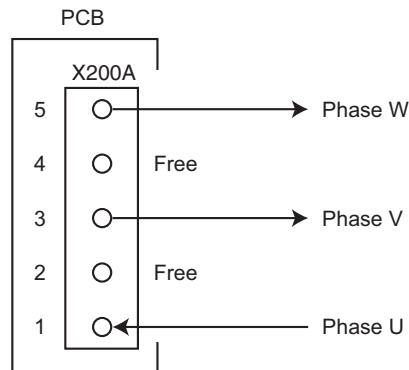

R6001166

■ 5MXM, 3/4/5MXT(H)

Check if the sinusoidal voltage is generated between pins 1 - 2 and 2 - 3 when the fan motor is manually rotated once.

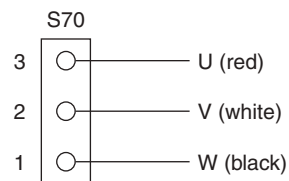

R6000524

10.9 Installation Condition Check

Check No.17

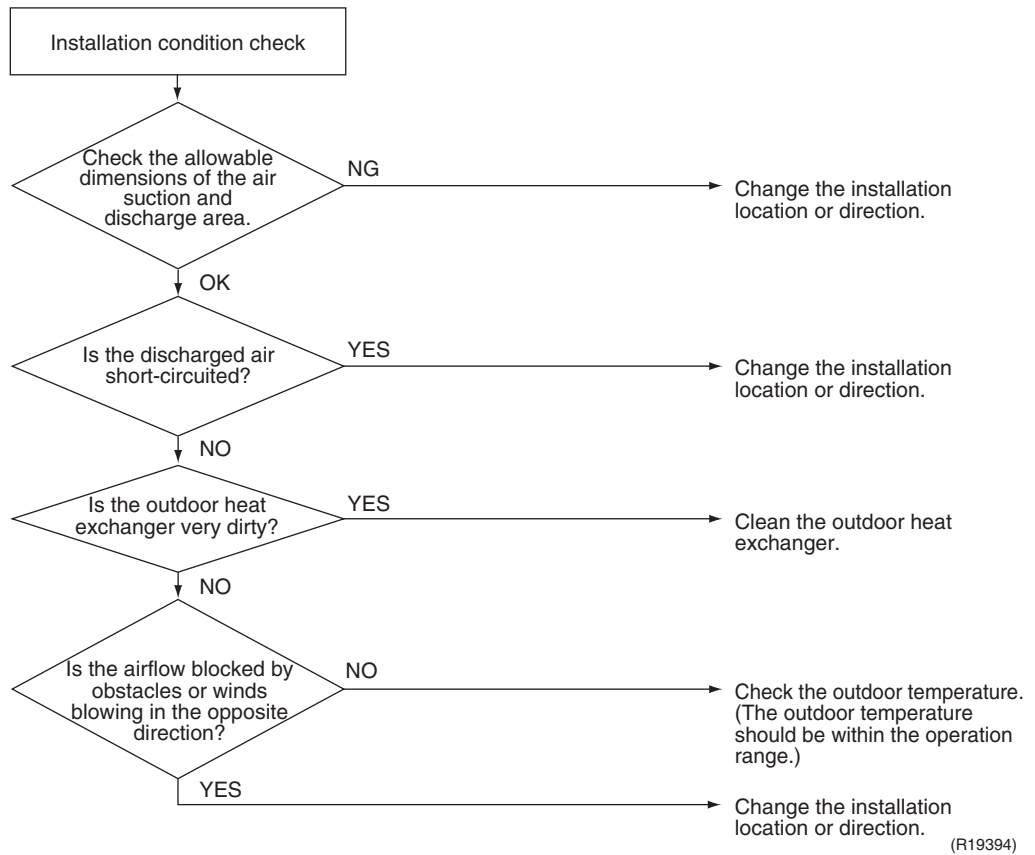

10.10 Discharge Pressure Check

Check No.18

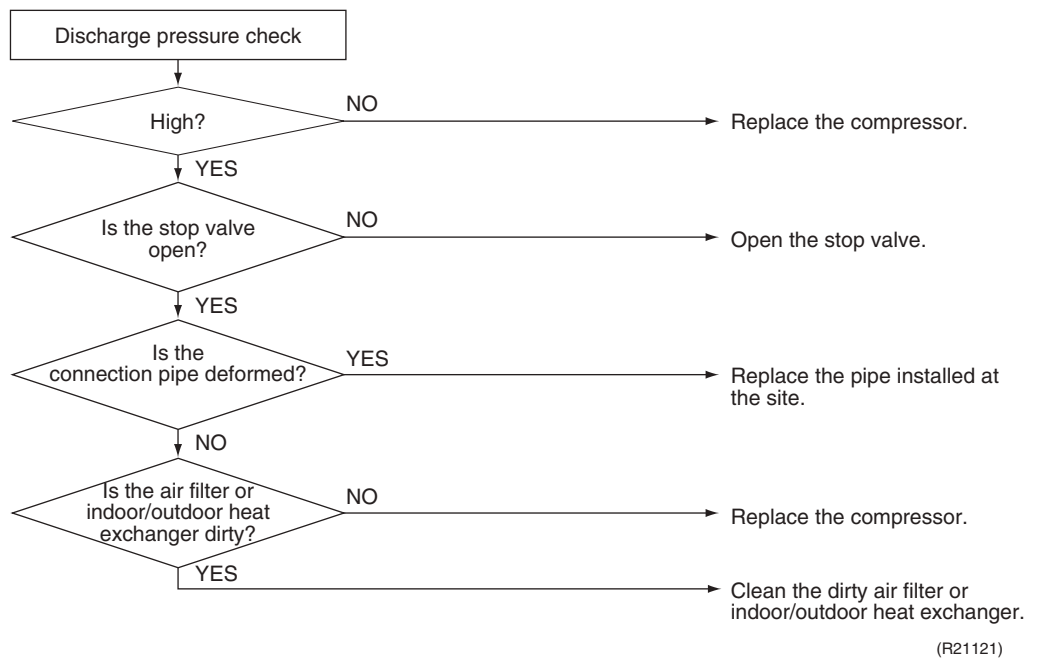

10.11 Outdoor Fan System Check

Check No.19

DC motor

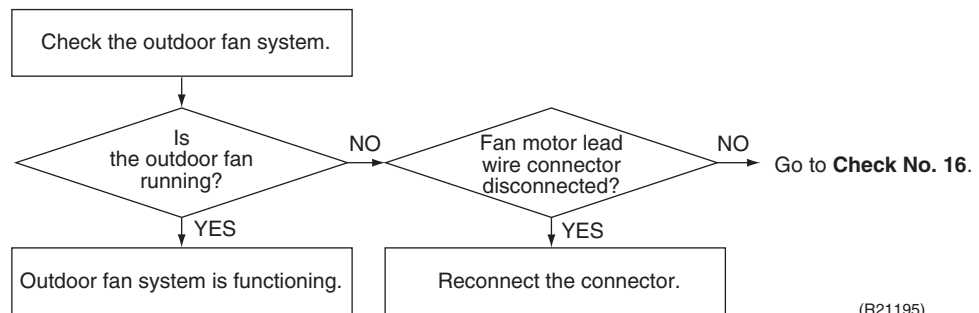

(R21195)

10.12 Main Circuit Short Check

Check No.20

Check to make sure that the voltage between (+) and (-) of the diode bridge (DB1) is about 0 V before checking

- Measure the resistance between the pins of the DB1 referring to the table below.
- If the resistance is ∞ or less than 1 k Ω , short circuit occurs on the main circuit.

Positive terminal (+) of digital multimeter	~ (2, 3)	+ (4)	~ (2, 3)	- (1)
Negative terminal (-) of digital multimeter	+ (4)	~ (2, 3)	- (1)	~ (2, 3)
Resistance is OK.	several k Ω ~ several M Ω			
Resistance is NG.	0 Ω or ∞			

■ 2/3/4MXM, 2MXT

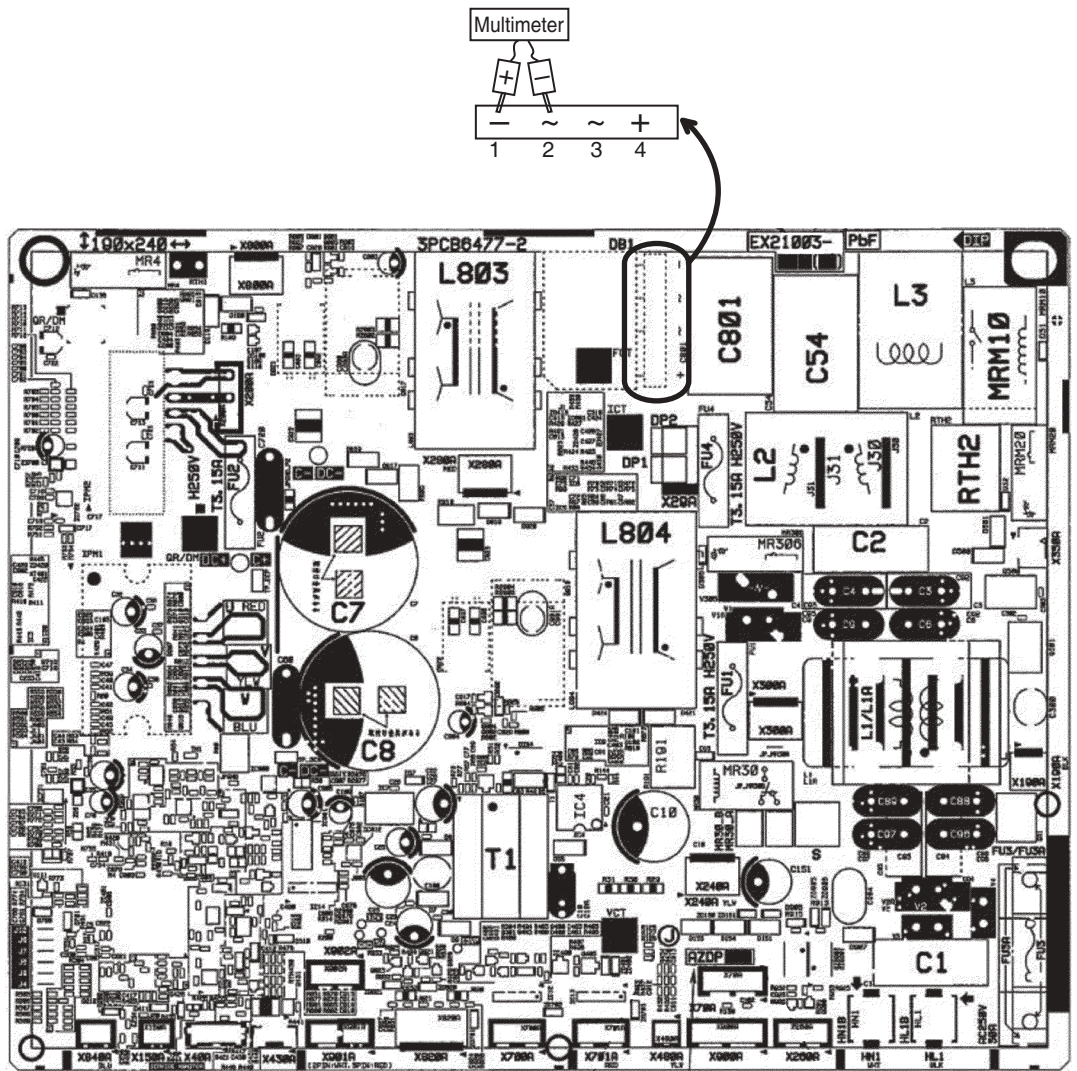

R6001176

■ 5MXM, 3/4/5MXT, 3/4/5MXTH

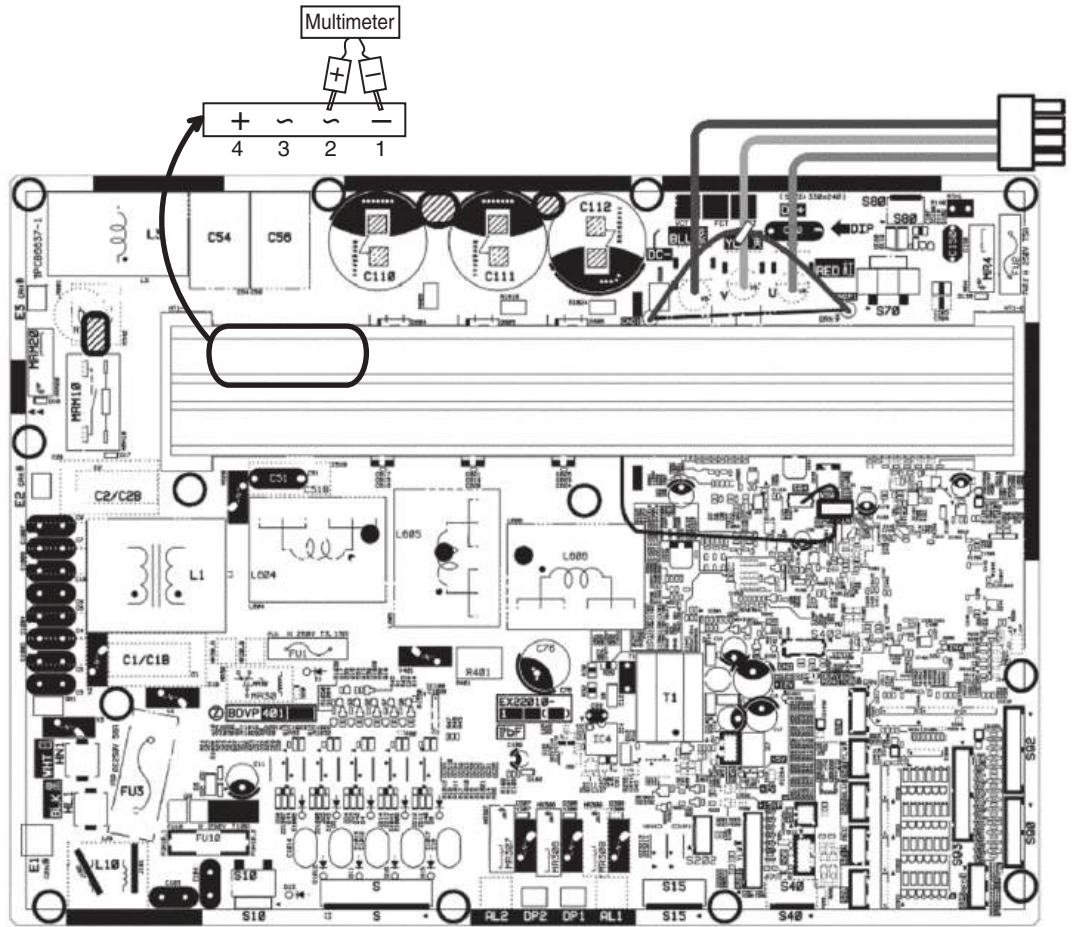

R6001314

10.13 Capacitor Voltage Check

Check No.21

Before this check, turn the circuit breaker off and wait for 10 minutes for prevention of electric shock.

■ 2/3/4MXM, 2MXT(H)

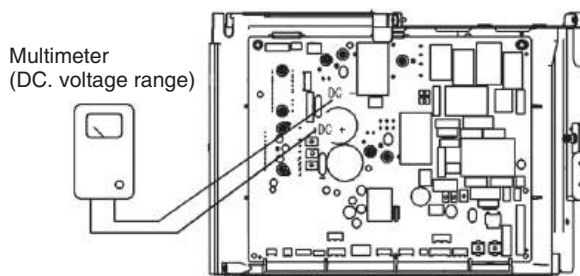

R6001172

- To prevent electrical shock, use a multimeter to check that the voltage between DC + and DC – is 50 V or less.
- The surface of the test points (DC +, DC –) may be covered with the coating. Be sure to make firm contact between the multimeter probes and the test points.

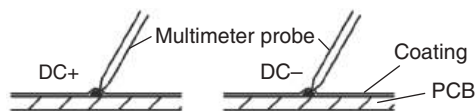

R6001173

■ 5MXM, 3/4/5MXT(H)

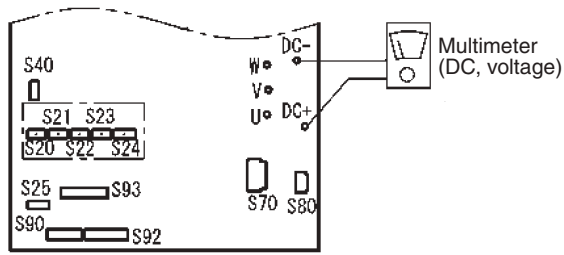

R6000525

- To prevent an electrical shock, use a multimeter to check that the voltage between DC + and DC – is 50 V or less.
- The surface of the test points (DC +, DC –) may be covered with the coating. Be sure to make firm contact between the multimeter probes and the test points.

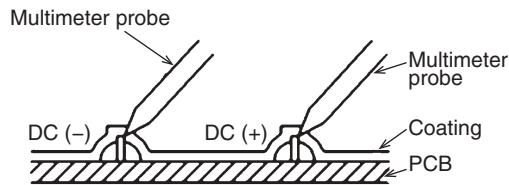

R6000551

10.14 Power Module Check

Check No.22

Check to make sure that the voltage between (+) and (-) of the power module is about 0 V before checking.

- Disconnect the compressor harness connector from the outdoor unit PCB. To disengage the connector, press the protrusion on the connector.
- Follow the procedure below to measure resistance between the (+) or (-) terminal of the power module and the U, V, or W terminal of the compressor with a multimeter. Evaluate the measurement results referring to the following table.

Positive terminal (+) of digital multimeter	Power module (+)	UVW	Power module (-)	UVW
Negative terminal (-) of digital multimeter	UVW	Power module (+)	UVW	Power module (-)
Resistance is OK.	several kΩ ~ several MΩ			
Resistance is NG.	0 Ω or ∞			

10.15 High Pressure Sensor Check

Check No.23

High pressure sensor

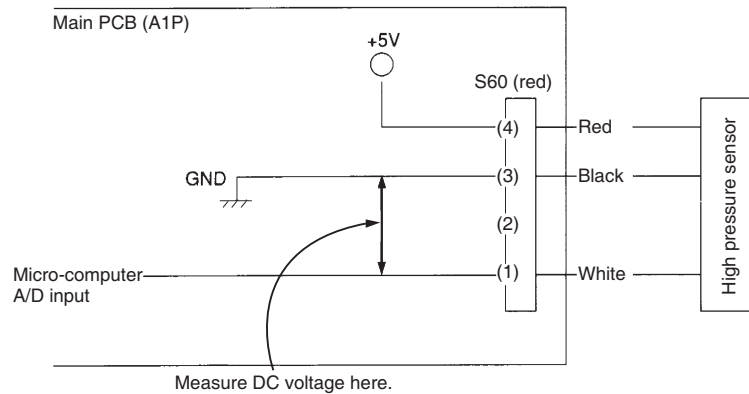

Pressure sensor and voltage characteristics

R6001352

- Detected pressure
0 ~ 4.15 MPaG
- Output voltage
0.5 V at 0 MPaG
3.5 V at 4.15 MPaG

10.16 Fan Motor Connector Check for CMXV Models

Check No.24

CHECKING ECM MOTORS

CMXV models utilize 4-wire variable speed ECM blower motor. The ECM blower motor provides constant CFM.

The motor is a serially communicating variable speed motor. Only four wires are required to control the motor: +Vdc, Common, Receive, and Transmit.

The +Vdc and Common wires provide power to the motor's low voltage control circuits.

General Checks / Considerations

1. Check power supply to the CMXV model. Ensure power supply is within the range specified on rating plate.
2. Check motor power harness. Ensure wires are continuous and make good contact when seated in the connectors. Repair or replace as needed.
3. Check motor control harness. Ensure wires are continuous and make good contact when seated in the connectors. Repair or replace as needed.
4. Check thermostat and thermostat wiring. Ensure thermostat is providing proper cooling/heating/continuous fan demands. Repair or replace as needed.
5. Check blower wheel. Confirm wheel is properly seated on motor shaft. Set screw must be on shaft flat and torqued to 165 in-lbs minimum. Confirm wheel has no broken or loose blades. Repair or replace as needed.
6. Ensure motor and wheel turn freely. Check for interference between wheel and housing or wheel and motor. Repair or replace as needed.
7. Check housing for cracks and/or corrosion. Repair or replace as needed.
8. Check motor mounting bracket. Ensure mounting bracket is tightly secured to the housing. Ensure bracket is not cracked or broken.

Nidec UltraCheck-EZ™ Diagnostic Tool

The Nidec UltraCheck-EZ™ diagnostic tool may be used to diagnose the ECM motor.



Warning

HIGH VOLTAGE!

Disconnect ALL power before servicing or installing. Multiple power sources may be present. Failure to do so may cause property damage, personal injury or death.

SERVICING

To use the diagnostic tool, perform the following steps:

1. Disconnect power to the CMXV model.
2. Disconnect the 4-circuit control harness from the motor.
3. Plug the 4-circuit connector from the diagnostic tool into the motor control connector.
4. Connect one alligator clip from the diagnostic tool to a ground source.
5. Connect the other alligator clip to a 24VAC source.

NOTE: The alligator clips are NOT polarized.

NOTE: The Ultra Check-EZ™ diagnostic tool is equipped with a non-replaceable fuse. Connecting the tool to a source other than 24VAC could damage the tool and cause the fuse to open. Doing so will render the diagnostic tool inoperable.

6. Turn on power to the CMXV model.



Warning

Line Voltage now present.

7. Depress the orange power button on the diagnostic tool to send a run signal to the motor. Allow up to 5 seconds for the motor to start.

NOTE: If the orange power button does not illuminate when depressed, the tool either has an open fuse or is not properly connected to a 24VAC source.

8. The green LED on the diagnostic tool will blink indicating communications between the tool and motor. See the following table for indications of tool indicators and motor actions. Replace or repair as needed.

Power Button	Green LED	Motor Action	Indication(s)
OFF	OFF	Not Rotating	Confirm 24VAC to UltraCheck-EZ™ tool. If 24VAC is confirmed, diagnostic tool is inoperable.
ON	Blinking	Rotating	Motor and control/end bell are functioning properly.
ON	OFF	Rotating	Replace motor control/end bell.
ON	Blinking	Not Rotating	Check motor (refer to Motor Checks on page 295).
ON	OFF	Not Rotating	Replace motor control/end bell; verify motor (refer to Motor Checks on page 295).

9. Depress the orange power button to turn off motor.
10. Disconnect power. Disconnect diagnostic tool.
11. Reconnect the 4-wire harness from control board to motor.

Electrical Checks - High Voltage Power Circuits



Warning

HIGH VOLTAGE!

Disconnect ALL power before servicing or installing. Multiple power sources may be present. Failure to do so may cause property damage, personal injury or death.

1. Disconnect power to the CMXV model.
2. Disconnect the 5-circuit power connector to the ECM motor.
3. Turn on power to the CMXV model.



Warning

Line Voltage now present.

4. Measure voltage between pins 4 and 5 on the 5-circuit connector. Measured voltage should be the same as the supply voltage to the CMXV model.

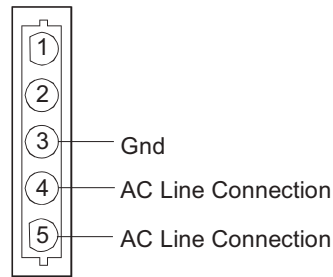

5. Measure voltage between pins 4 and 3. Voltage should be approximately half of the voltage measured in step 4.
6. Measure voltage between pins 5 and 3. Voltage should be approximately half of the voltage measured in step 4.
7. If no voltage is present, check supply voltage to the CMXV model.
8. Disconnect power to the CMXV model. Reconnect the 5-circuit power harness disconnected in step 2.

Electrical Checks - Low Voltage Control Circuits

1. Turn on power to the CMXV model.



Warning

Line Voltage now present.

2. Check voltage between pins on the 4-wire motor control harness between the motor and control board.
3. Voltage on pins should read:
 - Pins 1 to 4 = 3.3vdc
 - Pins 1 to 2 = 3.3vdc
 - Pins 3 to 4 = 15vdc

Motor Control/End Bell Checks



Warning

HIGH VOLTAGE!

Disconnect ALL power before servicing or installing. Multiple power sources may be present. Failure to do so may cause property damage, personal injury or death.

1. Disconnect power to the CMXV model.
 - NOTE:** Motor contains capacitors that can hold a charge for several minutes after disconnecting power. Wait 5 minutes after removing power to allow capacitors to discharge.
2. Disconnect the motor control harness and motor power harness.
3. Remove the blower assembly from the CMXV model.
4. Remove the (3) screws securing the control/end bell to the motor. Separate the control/end bell. Disconnect the 3-circuit harness from the control/end bell to remove the control/end bell from the motor.
5. Inspect the NTC thermistor inside the control/end bell. Replace control/end bell if thermistor is cracked or broken.

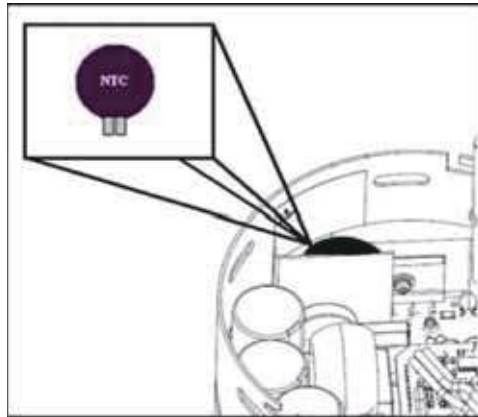

6. Inspect the large capacitors inside the control/end bell. Replace the control/end bell if any of the capacitors are bulging or swollen.

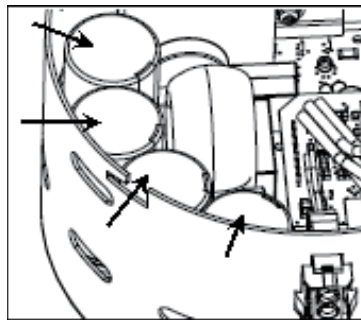

7. Locate the 3-circuit connector in the control/end bell. Using an ohmmeter, check the resistance between each terminal in the connector. If the resistance is $1\text{ M}\Omega$ or greater, the control/end bell is functioning properly. Replace the control/end bell if the resistance is lower than $1\text{ M}\Omega$.
8. Reassemble motor and control/end bell in reverse of disassembly. Replace blower assembly into the indoor unit.

Motor Checks



Warning

HIGH VOLTAGE!

Disconnect ALL power before servicing or installing. Multiple power sources may be present. Failure to do so may cause property damage, personal injury or death.

1. Disconnect power to the indoor unit.

NOTE: Motor contains capacitors that can hold a charge for several minutes after disconnecting power. Wait 5 minutes after removing power to allow capacitors to discharge.
2. Disassemble motor as described in steps 2 through 4 above.
3. Locate the 3-circuit harness from the motor. Using an ohmmeter, measure the resistance between each motor phase winding. The resistance levels should be equal. Replace the motor if the resistance levels are unequal, open circuited or short circuited.
4. Measure the resistance between each motor phase winding and the motor shell. Replace the motor if any phase winding is short circuited to the motor shell.
5. Reassemble motor and control/end bell in reverse of disassembly. Replace blower assembly into the CMXV model.

10.17 Network Troubleshooting (CMXV Only)

Check No.25

If a network communication error code has occurred, use the following steps to help troubleshoot the system.

After any wiring changes have been made or the dip switches of DS7 on the indoor unit control PCB have been changed, apply power to the system and see if the error codes have cleared.

1. Confirm low voltage wiring is correct per installation instructions. Check for miswiring. (i.e. Terminal 1 and 2 is reversed.)

NOTE: A removable plug connector is provided with the control to make thermostat wire connections. This plug may be removed, wire connections made to the plug and replaced. It is strongly recommended that you do not connect more than two wires into a single terminal in the field because there is a risk of the wires becoming loose, which may result in intermittent operation.

2. Check wires for damage. (i.e. Broken wire at terminal, broken inside wire nuts or damaged cable between units.)
3. Perform continuity check on wires to make sure cable is OK. Replace the cable if necessary.
4. Change both switch 1 and 2 of DS7 on the indoor unit control PCB to OFF. Power reset is not necessary. These dip switches change the termination resistance value of the communication circuit.

The PCB has some onboard LEDs that can be used to troubleshoot the network. Refer to the following table.

LED	Component Description	Approximate location	Color	State			Description
				Blinking	Solid ON	OFF	
LED 1	CPU MONITOR (HAP)	Near microcontroller, lower left quadrant of PCB.	Green	X			Only one blinking pattern available. This means the indoor unit PCB is operating properly.
						X	PCB is defective or not powered.
LED 2	COMN STATUS (H2P)	Near microcontroller, lower left quadrant of PCB.	Red		X		Only one blinking pattern available. This means that communication between indoor unit and outdoor unit has not been established properly.
						X	Communication has been established between indoor and outdoor units.
LED 3	H3P	Near button, lower right quadrant of PCB.	Green	X			Communication has been established between indoor unit and Thermostat.
						X	The thermostat is not connected or has failed to establish communication with the indoor unit.

10.18 Wiring for Daikin One Thermostat

Check No.26

Typical 18 AWG thermostat wire may be used to wire the system components. The allowable maximum wire length between indoor unit and thermostat is one hundred twenty-five (125) feet.

It is **STRONGLY** recommended that no more than two wires be connected in a single terminal. If two wires are used in a terminal, it is recommended the same type of wire be used (i.e. Both stranded or solid for secure connection). Failure to do so may result in intermittent operation. Refer to section Electrical Connections for 208/230 volts line connections to the CMXV air handler.

NOTE: For a detailed procedure of thermostat commissioning process, please visit the Daikin One+ website at <https://daikincomfort.com/pro>.

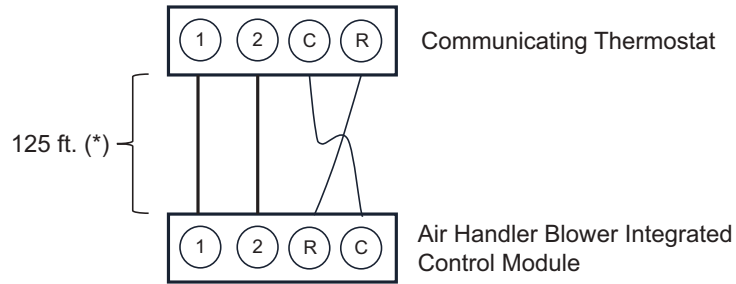

(*) Allowable Maximum Length

10.19 Pressure Sensor Voltage Check

Check No.27

The outdoor and indoor pressure sensor senses low pressure or high pressure. Follow the following sequence to check the pressure sensor.

1. Connect a voltmeter across the sensor terminals between pin 3 (black) and 1 (white) wiring. The voltmeter should show the voltage in the following table.
2. Replace the sensor if the sensor is open, shorted or outside the valid voltage range.

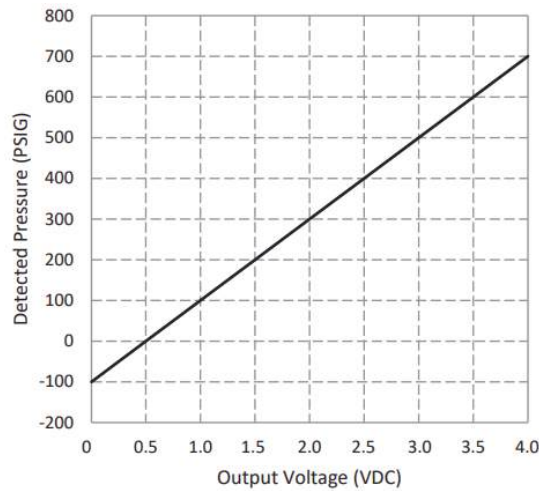

10.20 Transformer Check (CMXV Only)

Check No.28

A step-down transformer (208/230 or to 24 volt secondary) is provided with each indoor unit. This allow ample capacity for use with resistant heaters only for 208/230 V Air Handler models. Refer to the indoor unit WIRING DIAGRAM. Perform the following steps to verify the voltage on the transformer.



Warning

Disconnect all power before servicing.

1. Remove control panel cover, or etc., to gain access to transformer. With power ON:



Warning

Line voltage now present.

2. Using a voltmeter, check voltage across secondary voltage side of transformer (R to C).
3. No voltage indicates faulty transformer, bad wiring, or bad splices.
4. Check transformer primary voltage at incoming line voltage connections and/or splices.
5. If line voltage available at primary voltage side of transformer and wiring and splices are good, transformer is inoperative. Replace the transformer.

10.21 Duct Static Pressure Check (CMXV Only)

Check No.29

The minimum and maximum allowable duct static pressure for the indoor sections are found in the specifications section. Tables are also provided for each coil, listing quantity of air (CFM) versus static pressure drop across the coil. Too great an external static pressure will result in insufficient air that can cause icing of the coil. Too much air can cause poor humidity control and condensate to be pulled off the evaporator coil causing condensate leakage. Too much air can also cause motor overloading and in many cases this constitutes a poorly designed system.

To determine proper air movement, proceed as follows:

1. Using a draft gauge (inclined manometer), measure the static pressure of the return duct at the inlet of the unit, (Negative Pressure).

NOTE: If an air filter is installed, measure the static pressure between an air filter and air handler.

2. Measure the static pressure of the supply duct, (Positive Pressure).
3. Add the two (2) readings together for total absolute value of external static pressure (for example, $|-0.30 \text{ inH}_2\text{O}| + |0.20 \text{ inH}_2\text{O}| = 0.50 \text{ inH}_2\text{O}$ ($|-74.7 \text{ Pa}| + |49.8 \text{ Pa}| = 124.5 \text{ Pa}$) total static pressure).

NOTE: Both readings may be taken simultaneously and read directly on the manometer if so desired.

4. Consult proper table for quantity of air.

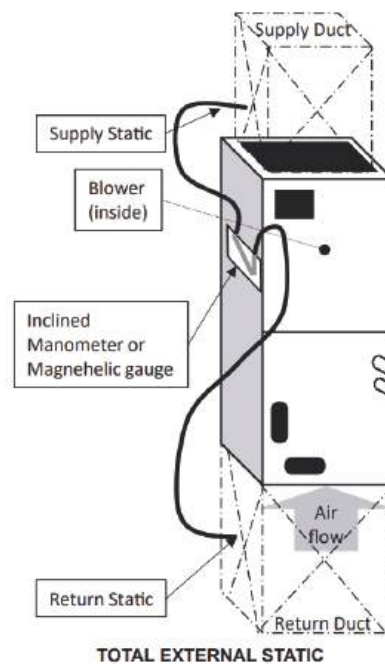

Part 7

Trial Operation and Field Settings

1. Pump Down Operation.....	300
2. Forced Cooling Operation.....	301
3. Wiring Error Check Function.....	302
4. Trial Operation.....	304
4.1 Wall Mounted Type.....	304
4.2 Duct Concealed Type.....	306
4.3 Floor Standing Type.....	308
4.4 Air Handling Units.....	310
5. Field Settings for Wall Mounted and Floor Standing Type.....	311
5.1 When 2 Units are Installed in 1 Room.....	311
5.2 Temperature Display Switch.....	315
5.3 Service Mode of Wireless Remote Controller.....	316
6. Field Settings for Duct Concealed Type.....	321
6.1 How to Change the Field Settings.....	321
6.2 Overview of Field Settings.....	323
6.3 MAIN/SUB Setting when Using 2 Wired Remote Controllers.....	326
7. Field Settings for Air Handling Units.....	327
7.1 How to Change the Field Settings.....	327
7.2 Overview of Field Settings for CMXV.....	327
7.3 Setting of DIP Switches (CMXV Only).....	331
8. Field Settings for Outdoor Unit.....	332
8.1 Priority Room Setting.....	332
8.2 COOL/HEAT Mode Lock.....	333
8.3 NIGHT QUIET Mode.....	334
8.4 Drain Pan Heater.....	334
9. Silicone Grease on Power Transistor/Diode Bridge.....	335

1. Pump Down Operation

Outline

In order to protect the environment, be sure to conduct pump down operation when relocating or disposing of the unit.

Details

■ 2/3/4MXM, 2MXT

1. Remove the valve cap from liquid stop valve and gas stop valve.
2. Carry out forced cooling operation.
3. After 3 to 5 minutes, close the liquid stop valve with a hexagonal wrench.
4. After 3 to 4 minutes, close the gas stop valve and stop forced cooling operation.
5. Attach the valve caps once procedures are complete.

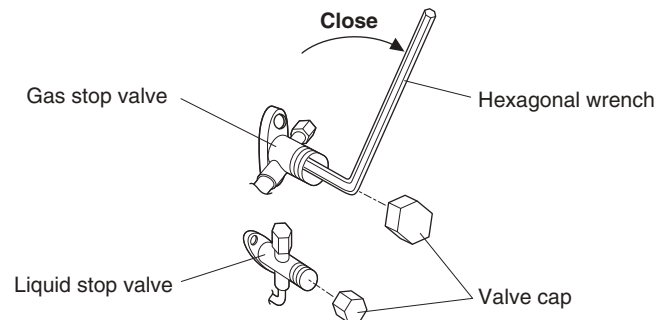

(R25062)

■ 5MXM, 3/4/5MXT, 3/4/5MXTH

1. Remove the valve caps from the liquid stop valve and the gas stop valve.
2. Carry out forced cooling operation.
3. After 1 - 2 minutes, close the liquid stop valve with a hexagonal wrench.
4. After 3 - 4 minutes, close the gas stop valve and stop the forced cooling operation.
5. Attach the valve caps once procedures are complete.

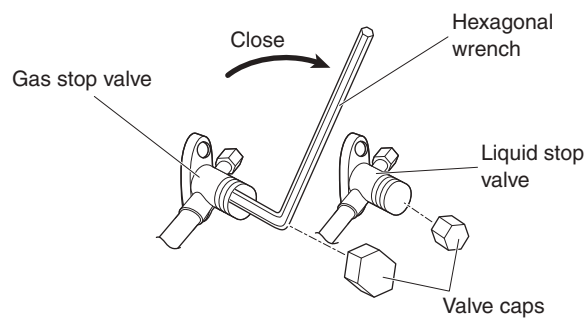

R7000216



Reference

Refer to page 301 for details of forced cooling operation.

2. Forced Cooling Operation

Outline

The forced cooling operation is allowed when both the following conditions are met.

1. The outdoor unit is not abnormal and not in the 3-minute standby mode.
2. The outdoor unit is not operating.

Protection functions have priority over all other functions during forced cooling operation.

Procedure

■ 2/3/4MXM, 2MXT

1. Turn off the power.
2. Remove the service lid (2 screws).
3. Remove the service monitor PCB switch cover (1 screw).
4. Switch SW5 and SW6 to off.
5. Turn the operation mode switch (SW2) to COOL.
6. Screw the service monitor PCB switch cover back on (1 screw).
7. Turn on the power.
8. Push the forced operation switch (SW1) above the service monitor PCB cover. (The operation will start.)
 - Forced cooling operation will stop automatically after about 11 ~ 15 minutes.
To stop the operation, press the forced operation switch (SW1) again.

■ 5MXM, 3/4/5MXT, 3/4/5MXTH

1. Turn off the power.
2. Remove the protection plate (right) (2 screws).
3. Remove the switch cover (1 screw).
4. Switch SW5 and SW6 to off.
5. Turn the operation mode switch (SW2) to COOL.
6. Screw the switch cover back on (1 screw).
7. Attach the protection plate (right) (2 screws).
8. Turn on the power.
9. Push the forced operation switch (SW1) above the service PCB cover. (The operation will start.)
 - Forced cooling operation will stop automatically after about 8 minutes.
To stop the operation, push the forced operation switch (SW1) again.

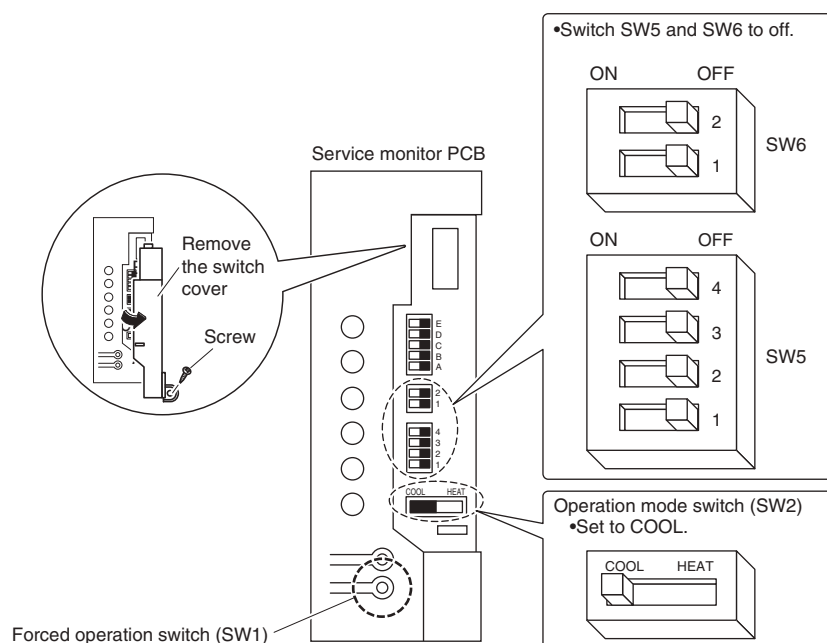

R7000217

3. Wiring Error Check Function

Outline

Wiring error check function is designed for the microcomputer to correct wiring errors itself. If local wiring is unclear in the case of buried piping, for example, just press the wiring error check switch on the outdoor unit. Even if the connections for Room A and Room B are confused, the system may run without a hassle.

Note that this check function does not work in the following cases.

- For 3-minute standby period after the power is turned on or after the compressor has stopped.
 - When the outdoor temperature is below 5°C (41°F).
 - If the indoor unit is in trouble (also in case of all-room transmission failure).
- When the piping and wiring are perfect, there is no need to use this function.

Procedure

1. Press the wiring error check switch (SW3) on the service monitor PCB of the outdoor unit, and the wiring error check function is activated.
2. In about 15 ~ 20 minutes, the check finishes automatically.
3. When the check is over, the service monitor LED indicators start blinking.

LED	1	2	3	4	5	Judgment
Status	Blinking one after another					Self-correction completed
	All blinking					Self-correction impossible
	Any of the LEDs stay on					Emergency stop

- Self-correction complete...The LED indicators blink one after another (only connected parts).
- Self-correction impossible...The LED indicators blink all at the same time.
 - Transmission failure occurs at any of the indoor units.
 - The indoor unit heat exchanger thermistor is disconnected.
 - An indoor unit is in trouble (if a trouble occurs during the wiring error checking).
- Emergency stop...If any of the LED indicators stays on, follow the diagnostic procedure.

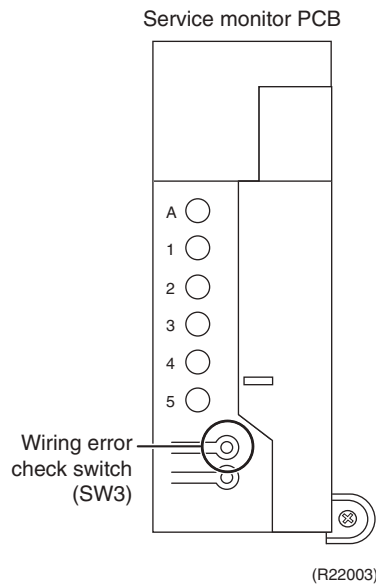

Details

- Wiring error check is realized by feeding refrigerant one by one through each piping port and detecting indoor heat exchanger temperature with the indoor heat exchanger thermistor in each room to see if the temperature changes in correct order.
- During wiring error check, freezing (cracking) noise may be heard from the indoor unit. This is not a malfunction. The noise is generated by the heat exchanger that is cooled below 0°C (32°F) to make temperature change more visible.
- Indoor fan motor turns on and off during wiring error check.

Wiring error check result is indicated using service monitor LEDs when all the checking procedures are completed. LEDs stop blinking when the system returns to the normal operation.

In a multi system with 2 ports (Port A and Port B), LED 1 and LED 2 indicate wiring to Room A and Room B respectively. The LED that blinks first and second indicate piping Port A and Port B respectively.

Ex: Suppose the LED indicators are blinking as follows.

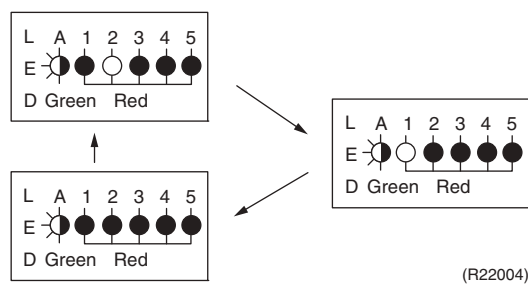

In this example, Port A and wiring to Room B are connected to the same room and Port B and wiring to Room A are connected to another room. Incorrect wiring is then corrected automatically.

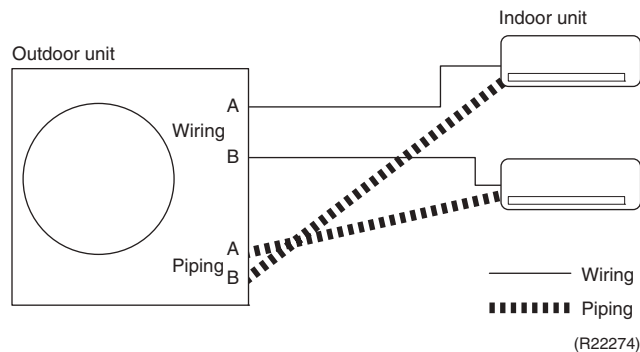

Notes

1. Wrongly connected liquid and gas pipes cannot be self-corrected. Be sure to make the liquid pipe and the gas pipe in pairs.
2. To cancel the wiring error check procedure halfway, press the wiring error check switch again.
In this case, the memory of the microcomputer returns to its initial status (Room A wiring → Port A piping, Room B wiring → Port B piping).
3. When replacing the outdoor unit PCB, be sure to use this function.
4. Make the priority room setting after wiring error check. If you set the priority room before wiring error check, the prioritized room may be changed after self-correction.

4. Trial Operation

4.1 Wall Mounted Type

Outline

- During the trial operation, first check the operation of each unit individually. After this, check the simultaneous operation of all indoor units. Check both COOL and HEAT operations.
 1. Measure the supply voltage and make sure that it is within the specified range.
 2. In COOL operation, select the lowest programmable temperature. In HEAT operation, select the highest programmable temperature.
 - When operating the air conditioner in COOL operation in winter, or HEAT operation in summer, activate trial operation mode by following the instructions in the installation manual for the indoor unit.
 3. Carry out the trial operation following the instructions in the operation manual to ensure that all functions and parts, such as the movement of the flap, are working properly.
 - To protect the air conditioner, restart operation is disabled for 3 minutes after the system has been turned off.
 - When trial operation is conducted in heating operation directly after the circuit breaker is turned on, in some cases no air will be output for about 3 to 20 minutes in order to protect the air conditioner.
 - During COOL operation, frost may form on the gas stop valve or other parts. This is normal.
 4. After running the unit for about 20 minutes, measure the temperatures at the indoor unit inlet and outlet.
 - If the measurements are above the values shown in the table below, then they are normal.

	COOL operation	HEAT operation
Temperature difference between inlet and outlet	About 14°F (8°C)	About 36°F (20°C)

(When running in one room)

5. After trial operation is complete, set the temperature to a normal level (78°F to 82°F (26°C to 28°C) in COOL operation, 68°F to 75°F (20°C to 24°C) in HEAT operation).

Procedure

When operating the air conditioner in cooling operation in winter, set it to the trial operation mode using the following method.

1. Press both of **TEMP** buttons and **OFF** button at the same time.
2. Press either of **TEMP ▲** or **TEMP ▼** button and select "T".
3. Press **FAN** button.
4. Press **COOL** or **HEAT** button. ("T" will be displayed and the unit will start forced cooling operation.)
5. Trial operation will stop automatically after about 30 minutes. To stop trial operation, press **OFF** button

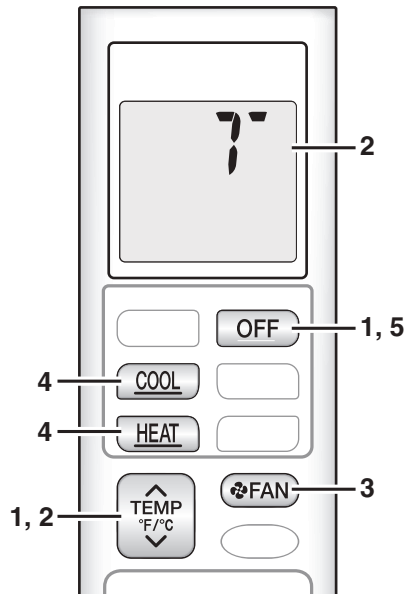

R7000445



Note(s)

- The air conditioner draws a small amount of power in its standby mode. If the system is not to be used for some time after installation, shut off the circuit breaker to eliminate unnecessary power consumption.
- If the circuit breaker trips to shut off the power to the air conditioner, the system will restore the original operation mode when the circuit breaker is opened again.

Test Items

Test items	Symptom
Indoor and outdoor units are installed securely.	Fall, vibration, noise
No refrigerant gas leaks.	Incomplete cooling/heating function
Refrigerant gas and liquid pipes and indoor drain hose extension are thermally insulated.	Water leakage
Draining line is properly installed.	Water leakage
System is properly earthed.	Electrical leakage
Only specified wires are used for all wiring and all wires connected correctly.	No operation or burn damage
Indoor or outdoor unit's air inlet or outlet are unobstructed.	Incomplete cooling/heating function
Stop valves are opened.	Incomplete cooling/heating function
Indoor unit properly receives remote controller commands.	No operation
Pipes and wires are connected to the corresponding terminal blocks/connection ports for the connected unit.	No cooling/heating
The priority room setting is set for only 1 room.	The priority room setting will not function.
Explain to the user that when using a smartphone for operation, it is necessary to prepare a repeater, or similar device, if the signal from the wireless LAN router is weak near the air conditioner.	Air conditioner not responding to smartphone

4.2 Duct Concealed Type

Outline

Trial operation should be carried out in either cooling or heating operation.

1. Measure the supply voltage and make sure that it is within the specified range.
2. In cooling operation, select the lowest programmable temperature; in heating operation, select the highest programmable temperature.
3. Carry out the trial operation following the instructions in the operation manual to ensure that all functions and parts, such as the movement of the flaps, are working properly.
 - To protect the air conditioner, restart operation is disabled for 3 minutes after the system has been turned off.
4. After trial operation is complete, set the temperature to a normal level (26°C to 28°C (78°F to 82°F) in cooling operation, 20°C to 24°C (68°F to 75°F) in heating operation).

Procedure

When operating the air conditioner in cooling operation in winter, or heating operation in summer, set it to the trial operation mode using the following method.

■ With Wired Remote Controller (BRC1NRV71)

1. Set to COOL or HEAT operation using the remote controller.
2. Press and hold **Cancel** button for 4 seconds or longer. Service settings menu is displayed.
3. In the case of a model having airflow direction function, select **Test Operation** in the service settings menu, and press **Menu/OK** button. Basic screen returns and "Test Operation" is displayed at the bottom.
4. Press **On/Off** button within 10 seconds, and the test operation starts. Monitor the operation of the indoor unit for a minimum of 10 minutes. During test operation, the indoor unit will continue to cool/heat regardless of the temperature setpoint and room temperature.
 - ◆ In the case of above-mentioned procedures 3 and 4 in reverse order, test operation can start as well.
5. Press and hold **Cancel** button for 4 seconds or longer in the basic screen. Service settings menu is displayed.
6. Select **Test Operation** in the service settings menu, and press **Menu/OK** button. Basic screen returns and normal operation is conducted.
 - ◆ Test operation will stop automatically after 15 ~ 30 minutes. To stop the operation, press **On/Off** button.

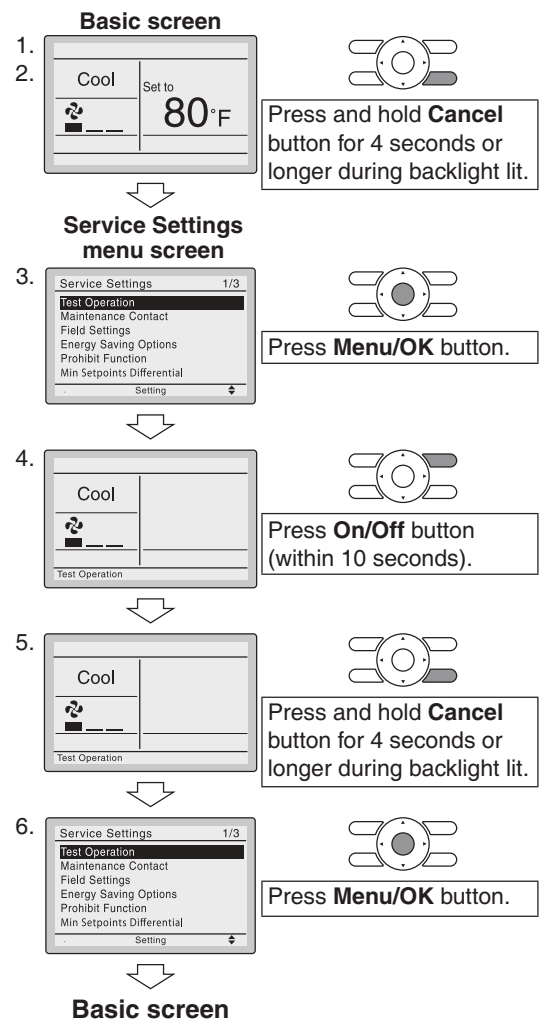

R7000501

Test Items

Test items	Symptoms
Indoor and outdoor units are installed securely.	Fall, vibration, noise
No refrigerant gas leaks.	Incomplete cooling/heating function
Refrigerant gas and liquid pipes and indoor drain hose extension are thermally insulated.	Water leakage
Draining line is properly installed.	Water leakage
The power supply voltage corresponds to that shown on the name plate.	No operation or burn damage
System is properly grounded.	Electrical leakage
Only specified wires are used for all wiring, and all wires are connected correctly.	No operation or burn damage
Indoor or outdoor unit's air inlet or air outlet are unobstructed.	Incomplete cooling/heating function
Refrigerant piping length and additional refrigerant charge are noted down.	The refrigerant charge in the system is not clear
Pipes and wires are connected to the corresponding connection ports / terminal blocks for the connected unit.	No cooling/heating
Stop valves are opened.	Incomplete cooling/heating function
The external static pressure is set correctly.	Incomplete cooling/heating function or water leakage

4.3 Floor Standing Type

Outline

Trial operation should be carried out in either cooling or heating operation.

1. Measure the supply voltage and make sure that it is within the specified range.
2. In cooling operation, select the lowest programmable temperature; in heating operation, select the highest programmable temperature.
3. Carry out the trial operation following the instructions in the operation manual to ensure that all functions and parts, such as the movement of the louvers, are working properly.
 - To protect the air conditioner, restart operation is disabled for 3 minutes after the system has been turned off.
4. After trial operation is complete, set the temperature to a normal level (26°C to 28°C (78°F to 82°F) in cooling operation, 20°C to 24°C (68°F to 75°F) in heating operation).

Procedure

When operating the air conditioner in cooling operation in winter, or heating operation in summer, set it to the trial operation mode using the following method.

1. Press **Temp Up**, **Down** and **Mode** button at the same time.
2. Press **Temp Up** or **Down** button, select "T", and press **Mode** button for confirmation.
3. Press **On/Off** button to turn on the system.
 - Trial operation will stop automatically after about 30 minutes. To quit trial operation, press **On/Off** button.
 - Some of the functions cannot be used in the trial operation mode.

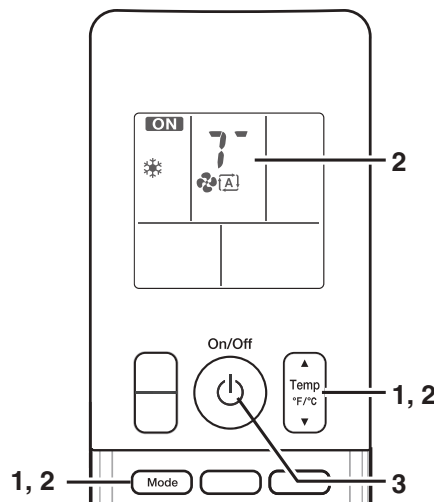

R7000370



Note(s)

- The air conditioner draws a small amount of power in its standby mode. If the system is not to be used for some time after installation, shut off the circuit breaker to eliminate unnecessary power consumption.
- If the circuit breaker trips to shut off the power to the air conditioner, the system will restore the original operation mode when the circuit breaker is turned on again.

Test Items

Test items	Symptoms
Indoor and outdoor units are installed securely.	Fall, vibration, noise
The titanium apatite deodorizing filter is properly attached to the air filter.	Unusual noise, condensation
The air filter is properly attached.	Unusual noise, condensation
No refrigerant gas leaks.	Incomplete cooling/heating function
Refrigerant gas and liquid pipes, and indoor drain hose extensions are thermally insulated.	Water leakage
Draining line is properly installed.	Water leakage
System is properly grounded.	Electrical leakage
Only specified wires are used for all wiring, and all wires are connected correctly.	Unit not operating or burn damage
Indoor and outdoor unit air inlets and air outlets are unobstructed.	Incomplete cooling/heating function
Stop valves are opened.	Incomplete cooling/heating function
Indoor units properly receive remote controller commands.	Unit not operating
Pipes and wires are connected to the corresponding terminal blocks/connection ports for the connected unit.	Not cooling/heating
Explain to the user that when using a smartphone for operation, it is necessary to prepare a repeater, or similar device, if the signal from the wireless LAN router is weak near the air conditioner.	Air conditioner not responding to smartphone
The setting for restrictions on upward airflow is configured correctly. (Applicable to concealed installations, etc.) Explained to the customer that while the restriction on upward airflow is enabled, airflow direction cannot be changed, and auto swing cannot be used.	Failure to cool/warm, condensation on the house structure, etc.
Address settings are correct. (If installing 2 indoor units in the same room.)	Unit not operating
All through-holes are completely sealed with putty.	Failure to detect refrigerant leakages, ingress of insects etc.
All packaging tape attached to the front panel and air filter have been removed.	Unusual noise

4.4 Air Handling Units

- **Daikin One Thermostat**

Refer to <https://daikincomfort.com/pro>.

5. Field Settings for Wall Mounted and Floor Standing Type

5.1 When 2 Units are Installed in 1 Room

Outline

When 2 indoor units are installed in one room, the 2 wireless remote controllers can be set for different addresses. Change the address setting of one of the 2 units.

Procedure

■ **ARC466A89 Wireless Remote Controller**

1. Remove the battery cover of the remote controller, and cut the address jumper (J4).
2. Press the center of **Temp** button and **Mode** button on the remote controller at the same time.
3. Select **A** (address setting) with **Temp Up** or **Temp Down** button, and press **Mode** button to enter the address setting mode.
Then, the indoor unit operation lamp blinks for 1 minute.
4. Press the indoor unit **ON/OFF** switch while the operation lamp is blinking.
 - If setting could not be carried out completely while the operation lamp was blinking, carry out the setting process once again from the beginning.
 - After setting, press **Cancel** button will cause the remote controller to return to the previous display.

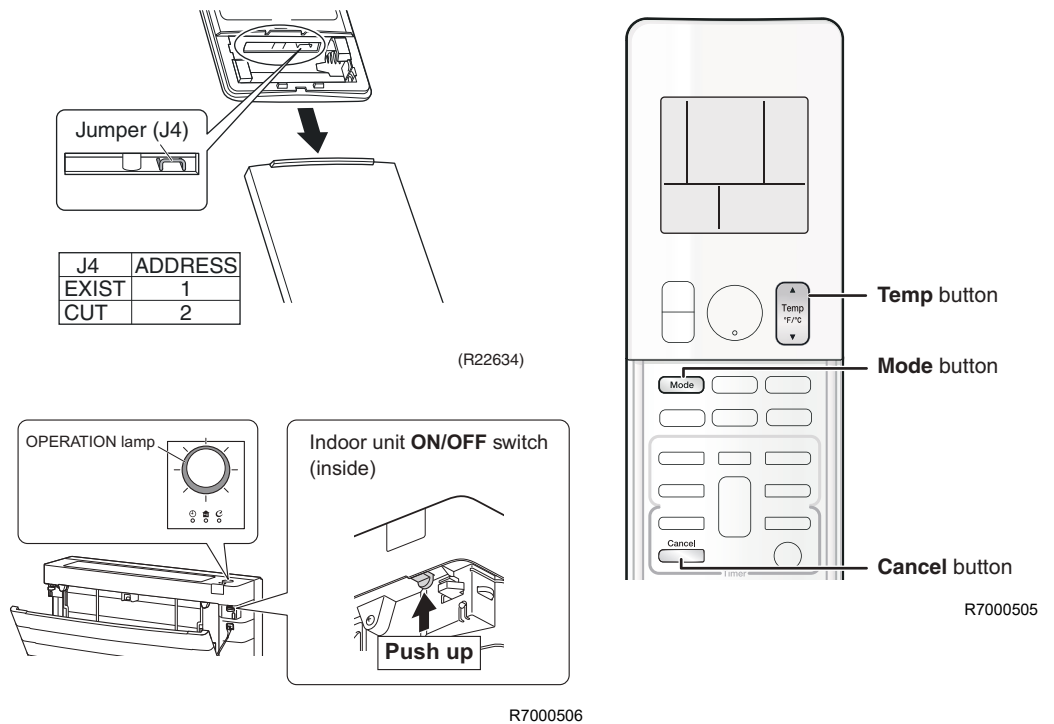

Caution

Replace the remote controller if you cut a jumper unintentionally.

Jumpers are necessary for electronic circuit. Improper operation may occur if you cut any of them.

Procedure

■ ARC480A83 Wireless Remote Controller

1. Remove the battery cover of the remote controller.
2. Cut the address jumper.
3. Press the center of **TEMP** button and **OFF** button on the remote controller at the same time.
4. Press **TEMP ▲** or **TEMP ▼** button to select **A** (address setting).
5. Press **FAN** button to enter the address setting mode.
Then, the indoor unit OPERATION lamp will blink for about 1 minute.
6. Press the indoor unit **ON/OFF** switch while the OPERATION lamp is blinking.
7. Press **FAN** button on the remote controller for 5 seconds to return to the previous display.

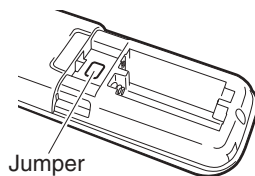

Jumper	Address
EXIST	1
CUT	2

R7000030

Indoor Unit

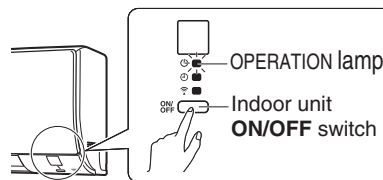

R7000448

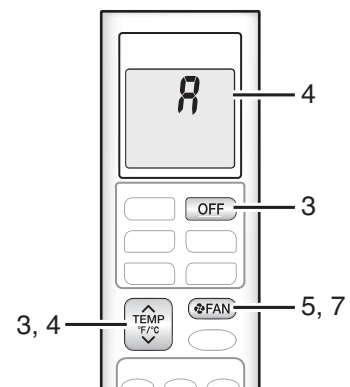

R7000447



Note(s)

If setting could not be carried out completely while the OPERATION lamp was blinking, carry out the setting process once again from the beginning.



Caution

Replace the remote controller if you cut a jumper unintentionally.

Jumpers are necessary for electronic circuit. Improper operation may occur if you cut any of them.

Procedure

■ BRC073A6 Wired Remote Controller

6-1 Press and hold the Cancel button for 4 seconds or longer. **6-1** The Service Settings menu is displayed.

<Basic screen>

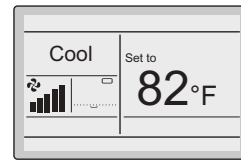

<Service Settings>

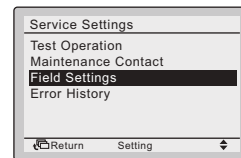

<Field settings>

6-2 Select **Field Settings** and press the Menu/Enter button. **6-2**

6-3 Highlight the "Mode No.", and select the desired "Mode No." by using the ▲▼ (Up/Down) buttons. **6-3**

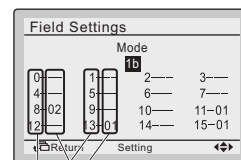

SECOND CODE NO.
FIRST CODE (SW) NO.

- The current settings are displayed.
- CODE NO. " -- " means that there is no function available.

6-4 Highlight the SECOND CODE of the FIRST CODE NO. to be changed and select the desired SECOND CODE NO. by using the ▲▼ (Up/Down) buttons. Multiple identical mode number settings are available.

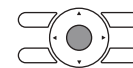

Press the Menu/Enter button.



6-5 Press the Menu/Enter button. The confirmation screen is displayed. **6-5**

6-6 Select **Yes** and press the Menu/Enter button. The settings are saved and the Field settings screen returns. **6-6**

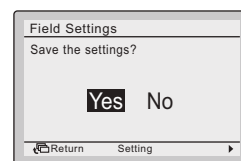

<Field Settings>

- 6-7** After all changes are completed, press the Cancel button twice.
- 6-8** The backlight goes out and "Checking the connection. Please stand by" is displayed during initialization. After the initialization, the Basic screen returns.

Mode No.	First Code No.	Description of the setting	Second code No.			
			01	02	03	04
1b	8	Daylight Saving Time	Disable	Enable*	—	—
	11	(Private use)	NA*	NA	—	—
	13	Basic screen display	Icon+Text*	Icon	—	—
	15	(Private use)	NA*	NA	—	—
1c	0	(Private use)	NA	NA*	—	—
	2	(Private use)	NA	NA*	—	—
	4	(Private use)	NA	NA*	—	—
	5	(Private use)	NA*	—	—	—
	6	(Private use)	NA*	—	—	—
	14	(Private use)	NA*	NA	—	—
1e	1	(Private use)	NA	NA*	—	—
	2	Setback function	Do not use	Heat only	Cool only	Cool and Heat*
	5	(Private use)	NA	NA*	—	—
	6	(Private use)	NA	NA*	—	—
	8	(Private use)	NA*	—	—	—
	9	(Private use)	NA	NA*	—	—
	a	(Private use)	NA*	—	—	—

* Factory default setting

5.2 Temperature Display Switch

ARC466A89

- Press the upper side of **Temp** button and **On** button at the same time for 5 seconds to change the unit of temperature display.

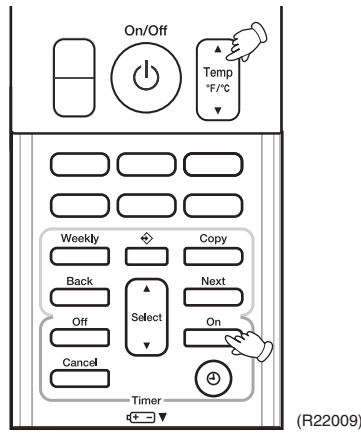

ARC480A83

- You can select Fahrenheit or Celsius for temperature display.
- Press **TEMP ▲** button and **ON TIMER** buttons simultaneously for 5 seconds to change the unit of temperature display.

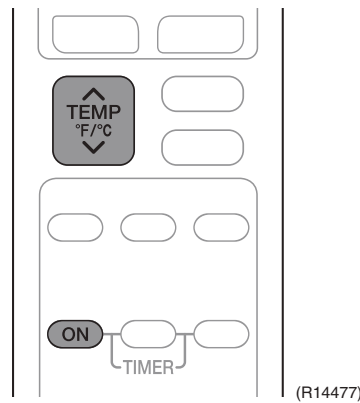

BRC073A6

You can select Fahrenheit or Celsius for temperature display.

- Display the Configuration menu.
- Press the ▲ or ▼ buttons to select "**Celsius / Fahrenheit**" and press the **Menu/Enter** button.

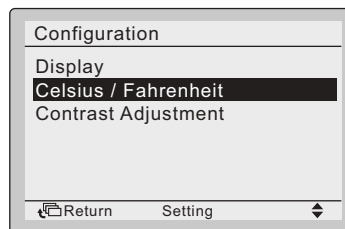

- Press the ▲ or ▼ buttons to select **Celsius** or **Fahrenheit**.
- Press the **Menu/Enter** button to confirm the settings and to return to the Basic Screen.

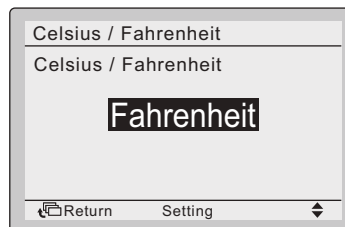

5.3 Service Mode of Wireless Remote Controller

■ ARC466A89 Wireless Remote Controller

The remote controller mode is hierarchized by special conditions and operation content. Refer below for the main hierarchy of the menu.

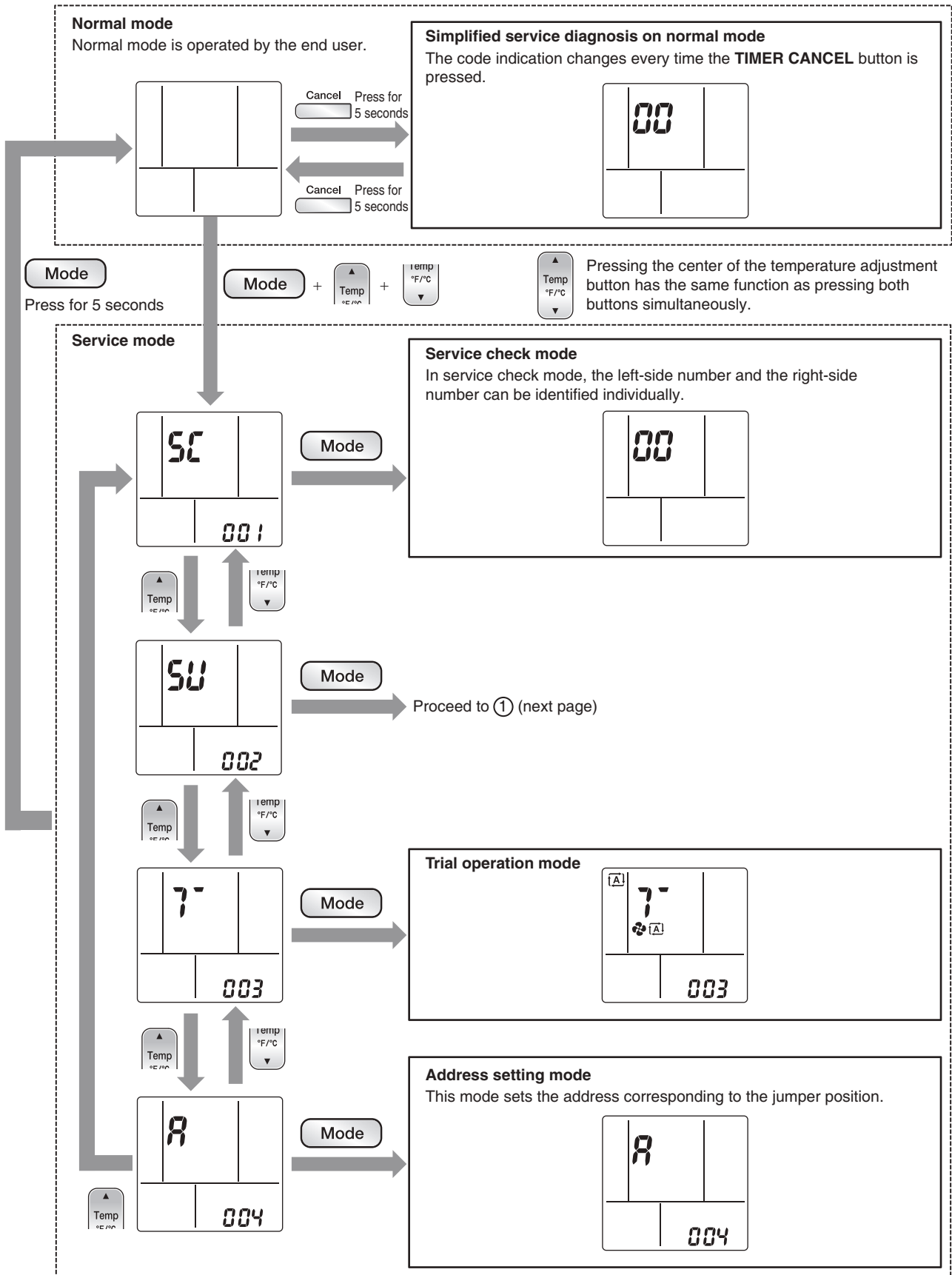

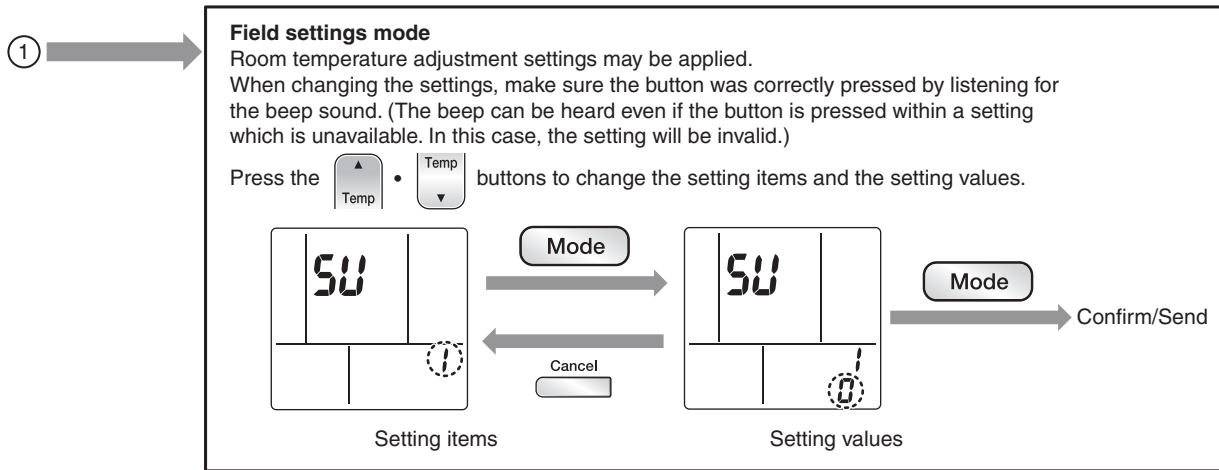

R5000447

Overview of the Settings

Setting items		Setting options	Factory setting	Contents
1	Brightness	N/A	N/A	Setting item number appears on the remote controller, but settings cannot be adjusted.
2	Filter cleaning setting	N/A	N/A	Setting item number appears on the remote controller, but settings cannot be adjusted.
3	Suspend	0: OFF 1: ON	1	Activation/Deactivation of Standby electricity saving (suspend function) 0: Power will still be supplied to the outdoor unit PCB after the unit operation stopped. 1: Three minutes after the unit operation stops, the power supply to the outdoor unit PCB is shut off.
4	Dry keep	0: OFF 1: ON	0	Stops the airflow of indoor unit when the thermostat is OFF to prevent increase in room humidity. 0: When thermostat is OFF, the fan rotor will still be OPERATING, hence there is airflow. 1: When thermostat is OFF, the fan rotor will be STOPPED, hence there is no airflow.
5	Preheating control	0: OFF 1: ON	0	Activation/Deactivation of compressor preheating 0: Deactivation of compressor preheating 1: Activation of compressor preheating
6	Room temperature adjustment (cooling)	0: Low 2 (-3.6°F(-2°C)) 1: Low 1 (-1.8°F(-1°C)) 2: Standard (0°F (0°C)) 3: High 1 (+1.8°F (+1°C)) 4: High 2 (+3.6°F(+2°C))	2	Adjustment of indoor temperature thermistor in cooling operation Used for adjustment of room temperature control.
7	Room temperature adjustment (heating)	0: Low 2 (-3.6°F(-2°C)) 1: Low 1 (-1.8°F(-1°C)) 2: Standard (0°F (0°C)) 3: High 1 (+1.8°F (+1°C)) 4: High 2 (+3.6°F(+2°C))	2	Adjustment of indoor temperature thermistor in heating operation. Used for adjustment of room temperature control.
8	Airflow setting when thermostat off during cooling operation	N/A	N/A	Setting item number appears on the remote controller, but settings cannot be adjusted.
9	Wireless/HA priority setting during automatic operation	0: Wireless 1: HA	0	Determination of priority control method when HA system is used. 0: Wireless remote controller can be used. 1: Temperature setting from wireless remote controller is disabled.
10	Auto-restart	0: OFF 1: ON	1	This setting decides the operation of the unit when the power supply resumes after a power supply shutdown (i.e. power failure). 0: When the power supply resumes, the unit remains in stopped operation. 1: When the power supply resumes, the unit resumes the operation before the shutdown of power supply.
11	Set temperature range	N/A	N/A	Setting item number appears on the remote controller, but settings cannot be adjusted.
12	Warmer airflow setting	N/A	N/A	Setting item number appears on the remote controller, but settings cannot be adjusted.

Setting items		Setting options	Factory setting	Contents
13	Fan setting when frost forms in low outdoor temperatures	0: Off 1: On	N/A	Setting options can be selected but changing them will not affect operation.
18	Internal clean streamer	N/A	N/A	Setting item number appears on the remote controller, but settings cannot be adjusted.
19	Fixed for heating only	N/A	N/A	Setting item number appears on the remote controller, but settings cannot be adjusted.
26	Heating indoor fan OFF delay	0: Off 1: On	0	Setting options can be selected but changing them will not affect operation.
27	Restricting upward airflow	0: Off 1: On	0	For concealed installations, fix the flap of the upper air outlet in the down position by setting the restriction on upward airflow.
99	EEPROM reset			

**Note(s)**

Set value on remote controller display may differ from the set value of indoor unit itself, as remote controller is not synchronized with indoor unit.

■ **ARC480A83 Wireless Remote Controller**

The remote controller mode is hierarchized by special conditions and operation content. Refer below for the main hierarchy of the menu.

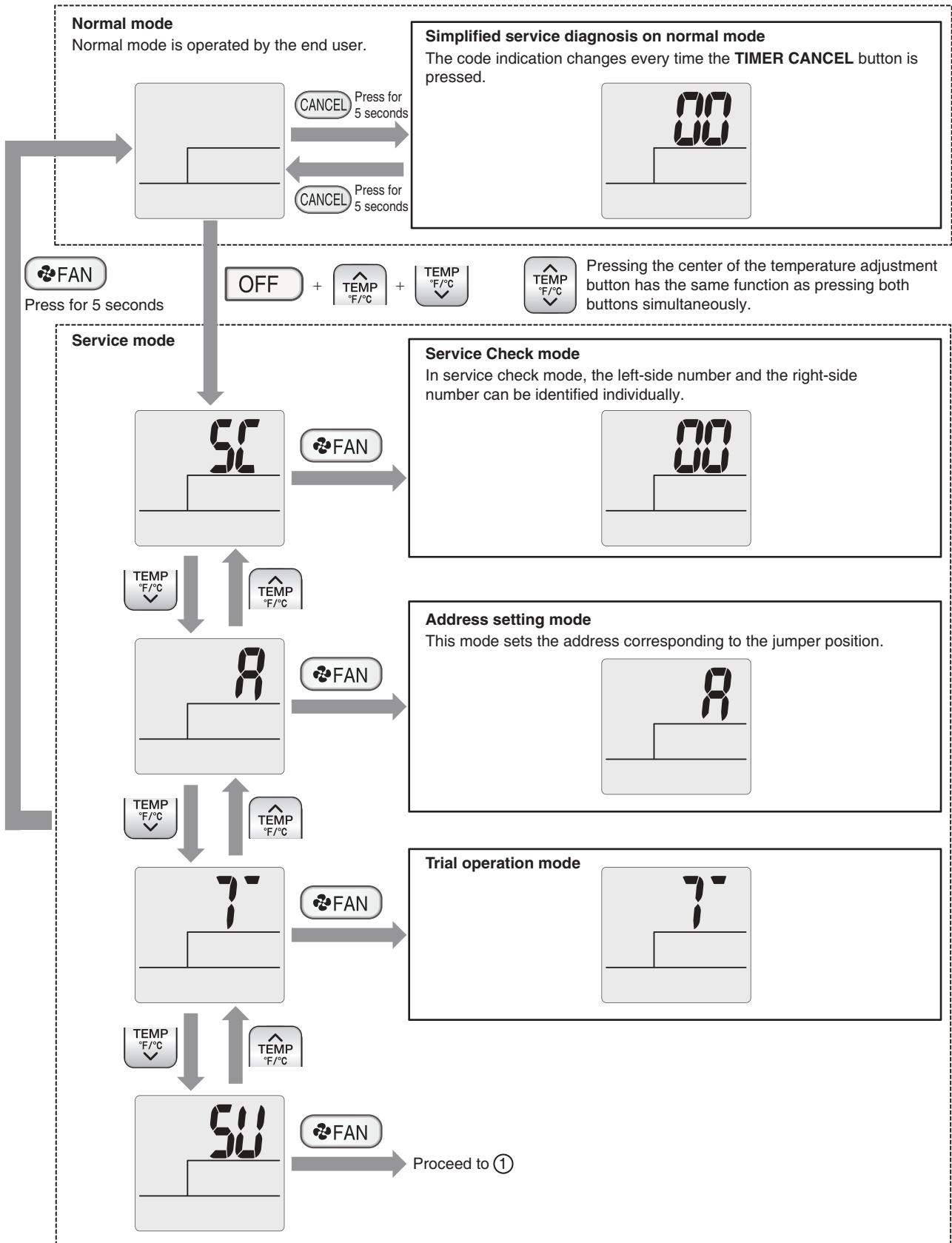

R5000463

6. Field Settings for Duct Concealed Type

6.1 How to Change the Field Settings

Outline

If optional accessories are mounted on the indoor unit, the indoor unit setting may have to be changed. Refer to the instruction manual for each optional accessory.

Note

When using 2 remote controllers for 1 indoor unit, change the field settings from MAIN remote controller. Note that the field settings cannot be set from SUB remote controller.

Procedure

BRC1NRV71 Wired Remote Controller

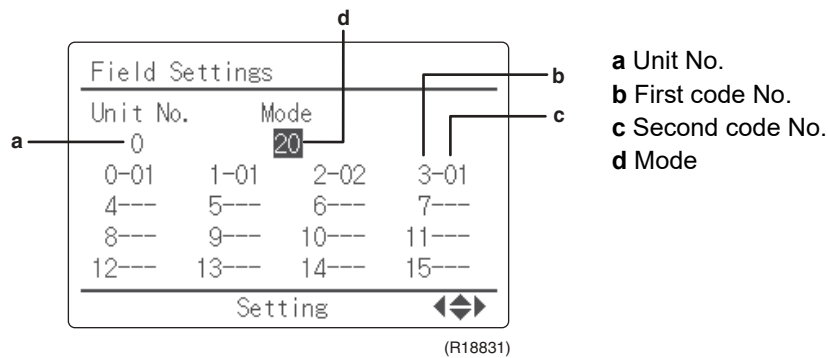

1. Press and hold **Cancel** button for 4 seconds or longer. Service settings menu is displayed.

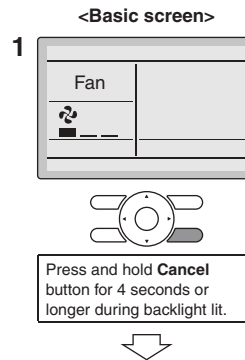

2. Select **Field Settings** in the Service Settings menu, and press **Menu/OK** button. Field settings screen is displayed.

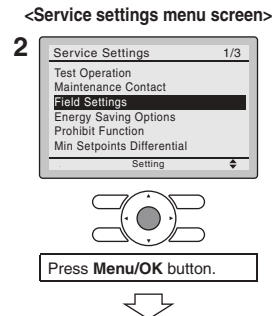

Highlight the mode, and select desired "Mode No." by using ▲ ▼ (Up/Down) button.

In the case of setting per indoor unit during group control (When Mode No. such as 20, 22, 23, 25 are selected), highlight the unit No. and select "Indoor unit No." to be set by using ▲ ▼ (Up/Down) button. (In the case of group setting, this operation is not needed.)

In the case of individual setting per indoor unit, current settings are displayed. And, SECOND CODE NO. " - " means no function.

Highlight SECOND CODE NO. of the FIRST CODE NO. to be changed, and select desired "SECOND CODE NO." by using ▲ ▼ (Up/Down) button. Multiple identical mode number settings are available.

In the case of setting for all indoor units in the remote control group, available SECOND CODE NO. is displayed as " * " which means it can be changed. When SECOND CODE NO. is displayed as " - ", there is no function.

<Service settings screen>

In the case of individual setting per indoor unit

3
4
5

In the case of group total setting

3
5



Press Menu/OK button.

Press **Menu/OK** button. Setting confirmation screen is displayed.

Select **Yes** and press **Menu/OK** button. Setting details are determined and field settings screen returns.

In the case of multiple setting changes, repeat 3 to 7.

After all setting changes are completed, press **Cancel** button twice.

Backlight goes out, and **[Checking the connection. Please stand by.]** is displayed for initialization. After the initialization, the basic screen returns.



<Setting confirmation screen>

6
7



Press Menu/OK button.



Setting confirmation

6.2 Overview of Field Settings

Mode No.	First Code No.	Description of setting		Second Code No.							
				01	02	03	04	05	06		
10 (20)	0	Filter cleaning sign interval (used to change filter cleaning display interval according to filter contamination)	Longlife filter	Light★	Approx. 2,500 hrs.	Heavy	Approx. 1,250 hrs.	—	—	—	—
			Standard filter		Approx. 200 hrs.		Approx. 100 hrs.	—	—	—	—
	2	Remote controller thermistor	Refer to the table below.								
	3	Filter cleaning sign (used to set filter cleaning display ON/OFF)	Display★	No display	—	—	—	—	—		
6	Remote controller thermistor control during group control	Not permitted★	Permitted	—	—	—	—	—			
11 (21)	7	Air volume adjustment	OFF★	Air volume adjustment completion	Air volume adjustment start	—	—	—			
	8	Room temperature adjustment (Cooling)	Refer to the table below.								
	9	Room temperature adjustment (Heating)	Refer to the table below.								
13 (23)	6	External static pressure	Refer to the table below.								
15 (25)	13	Refrigerant leak sensor setting	Disabled	Enabled★	—	—	—	—			
	14	Refrigerant leak sensor replacement	Normal★	Completion of replacement	—	—	—	—			

★ Factory Setting



Note(s)

- Do not use any settings not listed in the table.
- For group control, refer to the installation manual attached to the indoor unit for group control.

6.2.1 Remote Controller Thermistor

Select a thermistor to control the room temperature.

When the unit is not equipped with an infrared floor sensor:

Mode No.	First Code No.	Second Code No.	Contents
10 (20)	2	01	Remote controller thermistor and suction air thermistor
		02★	Suction air thermistor only★
		03	Remote controller thermistor only

★ Factory Setting

When the Second Code No. is set to **01**, room temperature is controlled by the suction air thermistor and remote controller thermistor. When the Second Code No. is set to **02**, room temperature is controlled by the suction air thermistor. When the Second Code No. is set to **03**, room temperature is controlled by the remote controller thermistor.

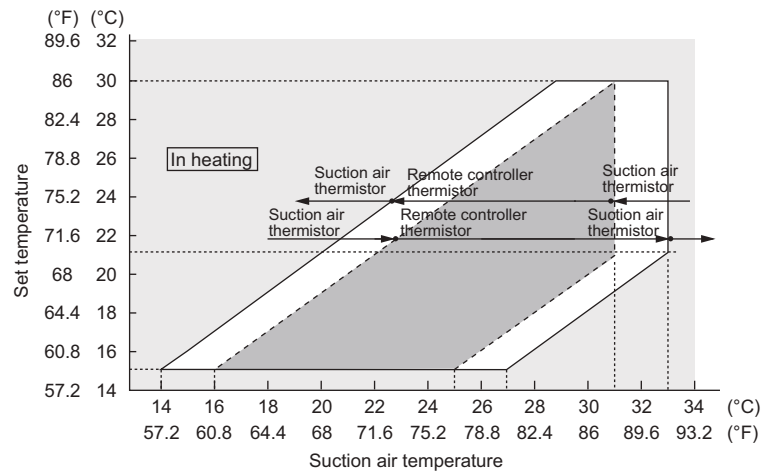
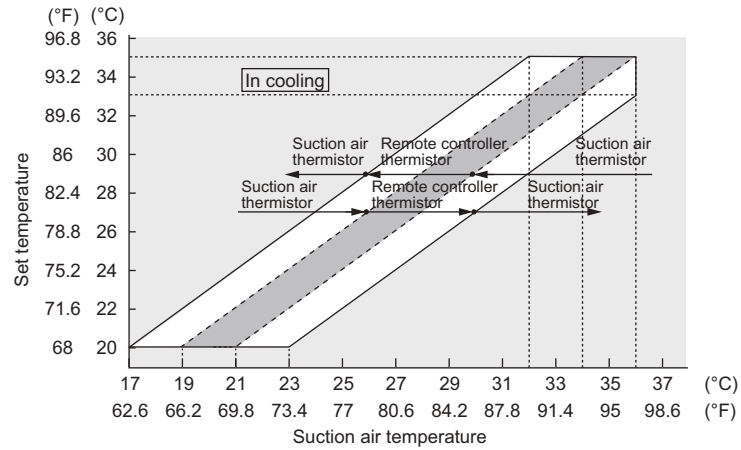

Room temperature adjustment (Cooling/Heating)

Mode No.	First Code No.	Second Code No.	Adjustment temperature
11 (21)	8.9	1	-3.5°C (-6.3°F)
		2	-3.0°C (-5.4°F)
		3	-2.5°C (-4.5°F)
		4	-2.0°C (-3.6°F)
		5	-1.5°C (-2.7°F)
		6	-1.0°C (-1.8°F)
		7	-0.5°C (-0.9°F)
		8 ★	0.0°C (0.0°F) ★
		9	+0.5°C (+0.9°F)
		10	+1.0°C (+1.8°F)
		11	+1.5°C (+2.7°F)
		12	+2.0°C (+3.6°F)
		13	+2.5°C (+4.5°F)
		14	+3.0°C (+5.4°F)
		15	+3.5°C (+6.3°F)

★ Factory Setting

External Static Pressure Settings

Mode No.	First Code No.	Second Code No.		External static pressure
		09/12 Class	15/18/24 Class	
13 (23)	6	03	—	30 Pa (0.12 inH ₂ O)
		04	—	40 Pa (0.16 inH ₂ O)
		05 ★	05 ★	50 Pa (0.20 inH ₂ O) ★
		06	06	60 Pa (0.24 inH ₂ O)
		07	07	70 Pa (0.28 inH ₂ O)
		08	08	80 Pa (0.32 inH ₂ O)
		09	09	90 Pa (0.36 inH ₂ O)
		10	10	100 Pa (0.40 inH ₂ O)
		11	11	110 Pa (0.44 inH ₂ O)
		12	12	120 Pa (0.48 inH ₂ O)
		13	13	130 Pa (0.52 inH ₂ O)
		14	14	140 Pa (0.56 inH ₂ O)
		15	15	150 Pa (0.60 inH ₂ O)

★ Factory Setting

6.2.2 Refrigerant Leak Sensor Setting

This is used when safety measures for refrigerant leak activated by the sensor is not required by the local and national codes based on the installation conditions such as refrigerant charge and room area.

★: Factory setting

Mode No.	First Code No.	Second Code No.	Contents
15 (25)	13	01	Disabled
		02★	Enabled★

6.2.3 Refrigerant Leak Sensor Replacement

After completion of replacement with a new sensor, change the Second Code No. to **02** to clear the error message on the remote controller. A reset of the power supply is also required to enable the setting.

★: Factory setting

Mode No.	First Code No.	Second Code No.	Contents
15 (25)	14	01★	Normal★
		02	Completion of replacement

6.3 MAIN/SUB Setting when Using 2 Wired Remote Controllers

Outline

The MAIN/SUB setting is necessary when 1 indoor unit is controlled by 2 remote controllers. When you use 2 remote controllers, set one to MAIN and the other to SUB.

Details

- The following message is displayed after power-on.

Checking the connection.

Please stand by.

When the above message is displayed, the backlight will not be ON.

[In the case that 1 indoor unit is controlled by 2 remote controllers:]

Make sure to set the sub remote controller when the above message is displayed.

Hold **Mode** button for 4 seconds or longer to set.

When the display is changed from "Main RC" to "Sub RC", the setting is completed.

- Basic screen is displayed.

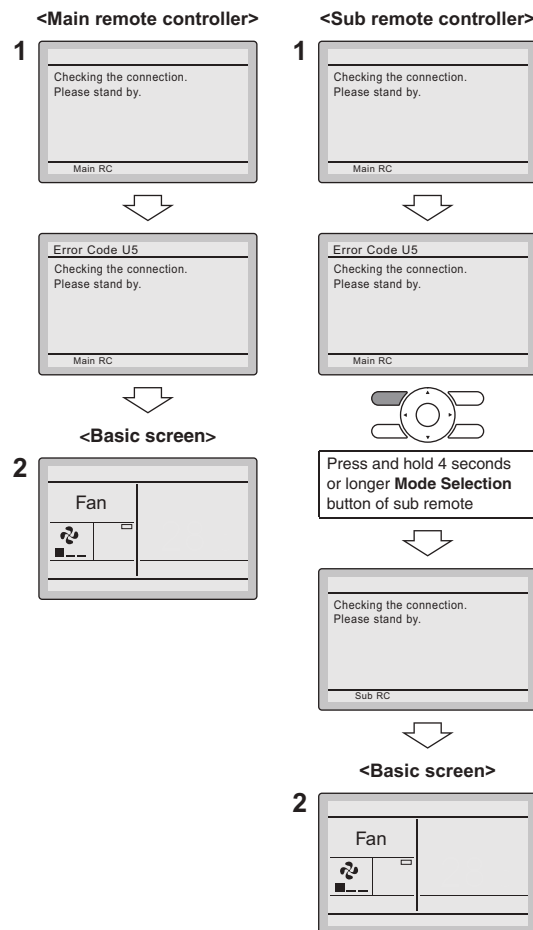

7. Field Settings for Air Handling Units

7.1 How to Change the Field Settings

Outline

If optional accessories are mounted on the indoor unit, the indoor unit setting may have to be changed. Refer to the instruction manual for each optional accessory.
The field settings may need to be changed as required when an optional kit and/or heater kit is installed, or as preferred by the customer.

Procedure

■ Daikin One Thermostat

Refer to <https://daikincomfort.com/pro>.

7.2 Overview of Field Settings for CMXV

★ Factory Setting

Field Setting Number	Description of setting	Selection					Reference Page	
		0	1	2	3	4		
1	Airflow setting when cooling/dry thermostat is OFF	LL Tap★	Set fan speed	OFF	Unused	Unused	327	
2	Airflow setting when heating thermostat is OFF	LL Tap	Set fan speed	OFF★	Unused	Unused	328	
3	Electric heater ON temperature: Ton	Refer to page on the right for details.					—	328
4	Electric heater OFF temperature: Toff							
5	Heater kit selection	Refer to page on the right for details.			—	—	329	
9	Accessory contacts	Heat ON	IND	Fan ON	None★	Unused	329	
11	Error priority setting	Refrigerant leak detection error priority★	Auxiliary alarm error priority	—	—	—	329	
12	Refrigerant leak detection sensor setting	Disabled	Enabled★	—	—	—	329	
13	Refrigerant leak test	OFF★	ON (60 minutes)	ON (120 minutes)	ON (180 minutes)	—	330	



Note(s)

- ◆ Do not use any settings that are not listed in the table.
- ◆ If settings not listed in the table are changed, press the Reset button at the bottom of the Field Setting menu. This reset button changes all field setting to the factory setting.

7.2.1 Airflow Setting when Cooling/Dry Thermostat is OFF

This is used to set airflow to LL airflow when cooling or dry thermostat is OFF.
If this setting is set to 2: OFF, the air in the room will be stagnant, which may prevent the thermostat from turning ON easily.

★: Factory setting

Field Setting Number	Selection	Contents
1	0★	LL Tap★
	1	Set fan speed
	2	OFF

7.2.2 Airflow Setting when Heating Thermostat is OFF

This is used to set airflow to LL airflow when heating thermostat is OFF. If this setting is set to 2: OFF, the air in the room will be stagnant, which may prevent the thermostat from turning ON easily.

*When this setting is set to 2: OFF, careful consideration is required before deciding installation location.

★: Factory setting

Field Setting Number	Selection	Contents
2	0	LL Tap
	1	Set fan speed
	2★	OFF★

7.2.3 Electric Heater ON/OFF Temperature

This setting determines the temperature at which an installed heater kit turns on/off. The heater kit turns on when the room thermistor temperature falls below (set temperature – Ton), and turns off when the room thermistor temperature rises above (set temperature – Toff).

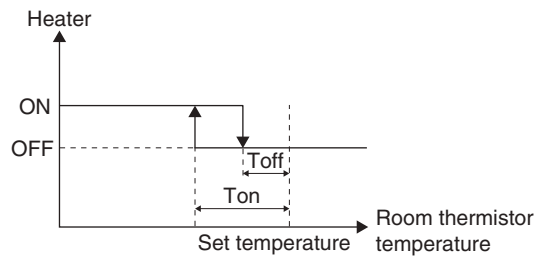

★: Factory setting

Field Setting Number	Symbol	Selection					
		0★	1	2	3	4	5
3	Ton	-4°C (-7.2°F)★	-3.5°C (-6.3°F)	-3°C (-5.4°F)	-2.5°C (-4.5°F)	-2°C (-3.6°F)	-1.5°C (-2.7°F)
4	Toff	-2°C (-3.6°F)★	-1.5°C (-2.7°F)	-1°C (-1.8°F)	-0.5°C (-0.9°F)	0°C (0°F)	0.5°C (0.9°F)

There is a limitation of combination between Ton and Toff as below due to 2°C (3.6°F) hysteresis required for reliability.

Settings			Ton [Field Setting 3]					
			0	1	2	3	4	5
			-4°C (-7.2°F)	-3.5°C (-6.3°F)	-3°C (-5.4°F)	-2.5°C (-4.5°F)	-2°C (-3.6°F)	-1.5°C (-2.7°F)
Toff [Field Setting 4]	5	0.5°C (0.9°F)	●	●	●	●	●	●
	4	0°C (0°F)	●	●	●	●	●	—
	3	-0.5°C (-0.9°F)	●	●	●	●	—	—
	2	-1°C (-1.8°F)	●	●	●	—	—	—
	1	-1.5°C (-2.7°F)	●	●	—	—	—	—
	0	-2°C (-3.6°F)	●	—	—	—	—	—

●: Available
 —: Not available

7.2.4 Heater Kit Selection

Refer to the table below to set the Heater Kit Selection from Daikin One Thermostat according to the capacity of the installed heater kit and the model.

★: Factory setting

Field Setting Number	Selection	Heater Kit Wattage (kW)		
		CMXV12	CMXV18	CMXV24
5	0★	No Heater★		
	1	3	3	5
	2	5	5	8
	3	—	8	10

7.2.5 Accessory Contacts

Refer to the table below to choose the accessory contacts setting from the Daikin One Thermostat. The details for each setting are described in Accessory Contacts (Humidifier Relay) on page 105.

★: Factory setting

Field Setting Number	Selection	Accessory Contacts Setting
9	0	Heat ON
	1	Independent
	2	Fan
	3★	None★
	4	Unused

7.2.6 Error Priority Setting

This setting is used to stop the indoor unit's fan operation when both a refrigerant leak is detected and a fire alarm (or similar devices) connected to Auxiliary Alarm terminals, labeled TB4 and TB5 is triggered. By default, the errors related to refrigerant leak (**A0-17/A0-19/CH-11/CH-14**) take priority over the auxiliary alarm error (**A0-01**). When the fire alarm is connected to the auxiliary alarm terminals and both leak detection error and auxiliary alarm error occur simultaneously, the indoor unit's fan continues operating to mitigate the refrigerant leak. This airflow could potentially spread the fire. If a fire alarm is installed and connected to the auxiliary alarm terminals, it is recommended to adjust this field setting to prioritize the auxiliary alarm error over the leak detection error, to ensure that the indoor unit's fan does not operate in the event of a fire.

★: Factory setting

Field Setting Number	Selection	Error Priority Setting
11	0★	Refrigerant Leak Detection Error Priority★
	1	Auxiliary Alarm Error Priority

7.2.7 Refrigerant Leak Detection Sensor Setting

This is used when safety measures for refrigerant leak activated by the sensor is not required by the local and national codes based on the installation conditions such as refrigerant charge and room area.

★: Factory setting

Field Setting Number	Selection	Error Priority Setting
12	0	Disabled
	1★	Enabled★

7.2.8 Refrigerant Leak Test

Refrigerant Leak Test allows manual activation of Relay K6R to verify that the optional kits connected to the Relay K6R operate properly. When the relay is closed, the zoning damper should fully open, the UV light should turn off, the ventilation should activate, and/or accessories that may be potential ignition sources should turn off. Refer to Leak Detection Output (Relay K6R) (CMXV Models) on page 104. Perform the test using one of the following procedures.

1. Via Dip Switches on Indoor Unit PCB

Refer to the following table to configure the dip switch [DS5] to start the Refrigerant Leak Test. The test will automatically end after the time specified in the table has elapsed, regardless of the DIP switch setting. To restart the test, set both switches 3 and 4 to OFF, then reconfigure the switches as needed.

★: Factory setting

DIPSW	Switches		Refrigerant Leak Test
	3	4	
DS5	OFF★	OFF★	OFF★
	OFF	ON	ON (60 mins)
	ON	OFF	ON (120 mins)
	ON	ON	ON (180 mins)

2. Via Daikin One Thermostat

From the commissioning menu of Daikin One Thermostat, navigate to “3. Equipment”, then select “indoor unit”, and open “field setting”. Select “Field Setting 13” and refer to the table below to adjust the setting and initiate the Refrigerant Leak Test. The test will automatically end once the time specified in the table has elapsed.

★: Factory setting

Field Setting Number	Selection	Refrigerant Leak Test
13	0★	OFF★
	1	ON (60 mins)
	2	ON (120 mins)
	3	ON (180 mins)

7.3 Setting of DIP Switches (CMXV Only)

The following table shows the factory DIP switch settings for the CMXV PCB.
Do not change the factory settings except the specified settings on the table.

DIP Switch #		Factory Setting	Function
DS1	1	OFF	Capacity Setting (*1)
	2	OFF	
	3	OFF	
	4	OFF	
DS4	1	OFF	No Use
	2	OFF	No Use
	3	OFF	No Use
	4	OFF	No Use
DS5	1	OFF	No Use
	2	OFF	No Use
	3	OFF	Refrigerant Leak Test (refer to Refrigerant leak test on page 361)
	4	OFF	
DS7	1	ON	Termination Resistance (refer to Network Troubleshooting (CMXV Only) on page 296)
	2	ON	

*1. Do not change the factory settings of these DIP switches except when replacing the installed PCB. Ensure that the unit is powered off before setting the DIP switches. Set the DIP switches according to the installed model, as shown in the table below.

Model	DIP Switch Setting			
	DS1			
	1	2	3	4
CMXV12	ON	OFF	OFF	ON
CMXV18	ON	OFF	ON	OFF
CMXV24	ON	OFF	ON	ON

NOTE 1: The AJ error code will be issued if the DIP switches are set to configurations other than those shown in the table.

NOTE 2: Once the capacity setting is performed, the capacity data stored in the microcomputer will be deleted and overwritten with the configured model setting.

8. Field Settings for Outdoor Unit

8.1 Priority Room Setting

Outline

The indoor unit for which priority room setting is applied takes priority in the following cases.

- Operation mode priority
The operation mode of the prioritized room takes precedence. For example, when the prioritized indoor unit starts cooling operation, the other indoor units which have been in heating operation enter the standby mode. Heating operation will resume if the prioritized indoor unit stops cooling operation.
- Priority during POWERFUL operation
The electronic expansion valves are controlled to provide more capacity to the prioritized room and the capacities for the other indoor units will be slightly reduced.
- OUTDOOR UNIT QUIET operation priority
When the OUTDOOR UNIT QUIET operation is selected in the prioritized room, the outdoor unit runs quietly.
Without priority room setting, OUTDOOR UNIT QUIET operation starts only when the function is set for all the operating indoor units.

Procedure

1. Turn the circuit breaker off before changing the setting.
2. Turn on the one of the switches of the SW4 on the service monitor PCB.
Only one room can be set as the priority room.
3. Turn the power on.

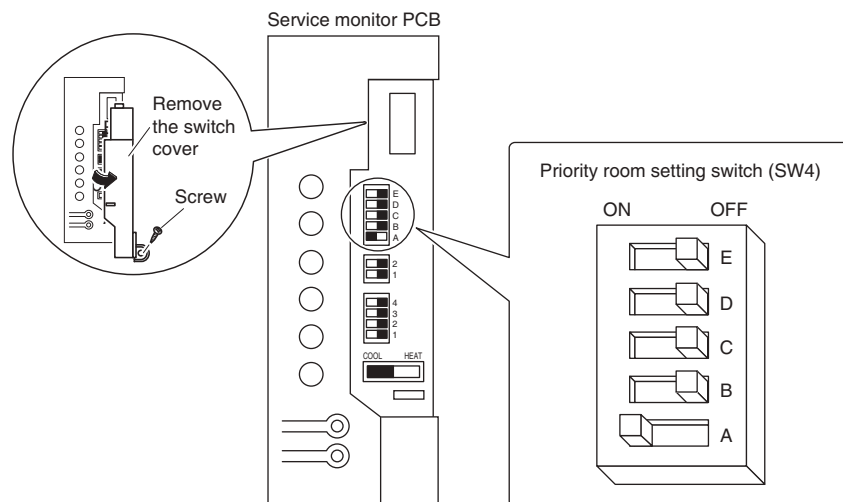

R7000367

8.2 COOL/HEAT Mode Lock

Use the X161A or S15 connector to set the unit to cooling only or heating only.
 Setting to heating only (H): short-circuit the pins 1 and 3 of the connector X161A or S15.
 Setting to cooling only (C): short-circuit the pins 3 and 5 of the connector X161A or S15.

The following specifications apply to the connector housing and pins.

- JST products:
 Housing: VHR-5N
 Pin: SVH-21T-P1.1
- 2/3/4MXM, 2MXT(H)

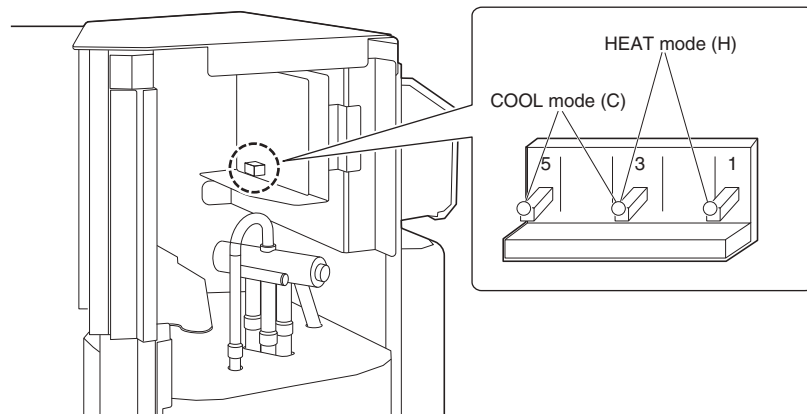

R7000449

- 5MXM, 3/4/5MXT(H)

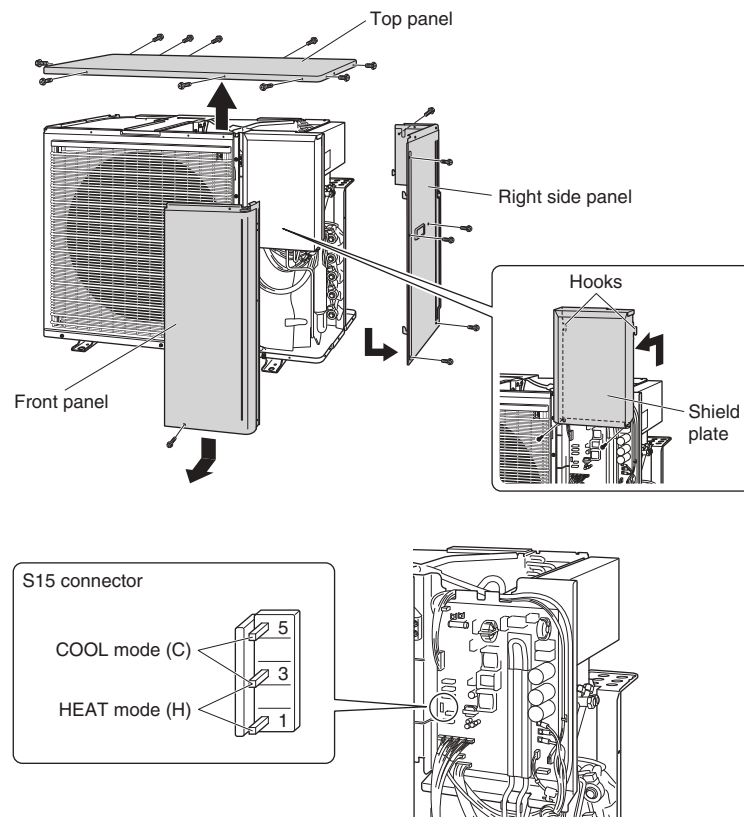

R7000163



Note(s) Forced operation is also possible in cooling/heating mode

8.3 NIGHT QUIET Mode

Outline

If NIGHT QUIET mode is to be used, initial settings must be made when the unit is installed. Explain the function of NIGHT QUIET mode, as described below, to the customer, and confirm whether or not the customer wants to use NIGHT QUIET mode.

NIGHT QUIET mode function reduces operating noise of the outdoor unit at nighttime. This function is useful if the customer is worried about the effects of the operating noise on the neighbors. However, if NIGHT QUIET mode is running, cooling capacity is reduced.

Procedure

Turn on the SW6-1 on the service monitor PCB of the outdoor unit.

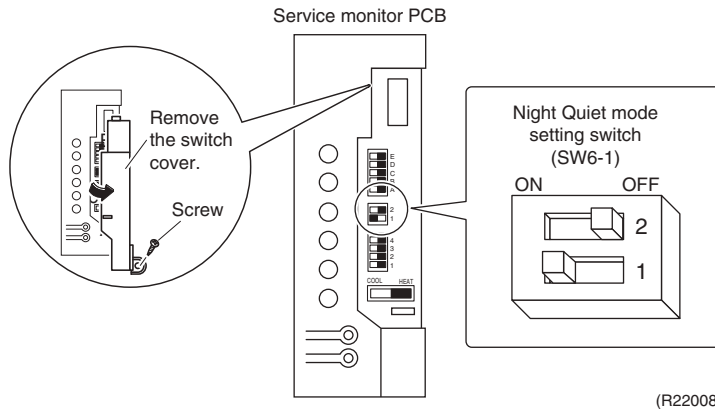

8.4 Drain Pan Heater

Applicable Models

2MXM18AVJU9(8), 3MXM24AVJU9(8), 4MXM36AVJU9(8), 5MXM48AVJU9(8)
 2MXT18AVJU9(8), 3MXT24AVJU9(8), 4MXT36AVJU9(8), 5MXT40AVJU9(8)

Outline

In high humidity areas or heavy snow areas, it is recommended to attach a drain pan heater to prevent ice build-up from the bottom frame. Field setting is necessary when attaching the optional drain pan heater.

Procedure

1. Attach the drain pan heater in accordance with the installation manual included with the drain pan heater.
2. Using a tool such as nippers, cut the jumper (J_DP) on the service monitor PCB.

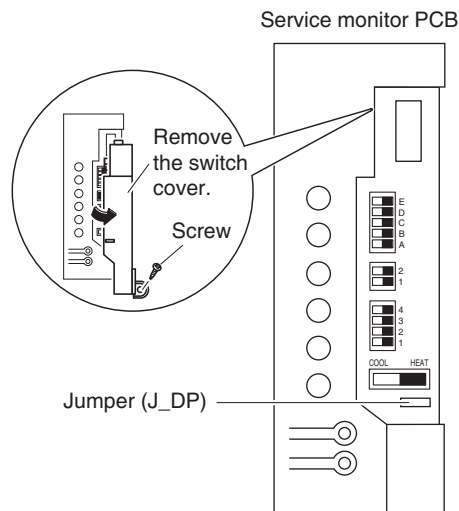

9. Silicone Grease on Power Transistor/Diode Bridge

Outline

Apply the specified silicone grease to the heat generation part of a power transistor/diode bridge when you replace an outdoor unit PCB. The silicone grease encourages the heat dissipation of a power transistor/diode bridge.

Details

1. Wipe off the old silicone grease on the refrigerant pipe completely.
2. Apply the silicone grease on the heat sink evenly. See the illustrations below for examples of application.
3. Tighten the screws of cover.
4. Make sure that the heat generation parts are firmly contacted to refrigerant pipe.



Note(s)

Smoke emission may be caused by bad heat radiation when the silicone grease is not appropriately applied.

- OK: Evenly applied

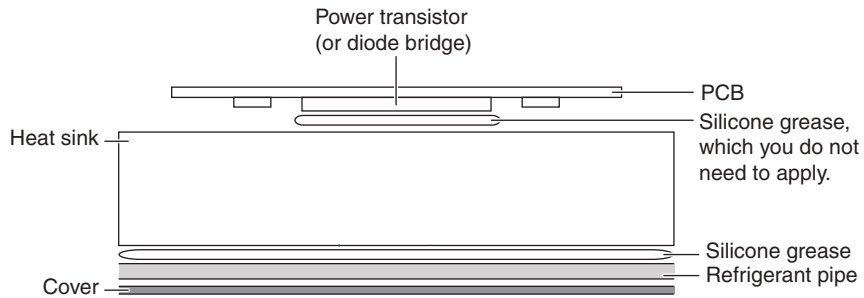

R7000168

- NG: Not evenly applied

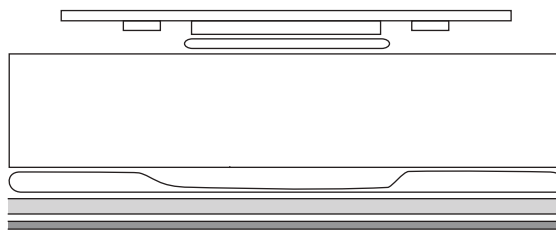

R7000158

- NG: Foreign matter is stuck.

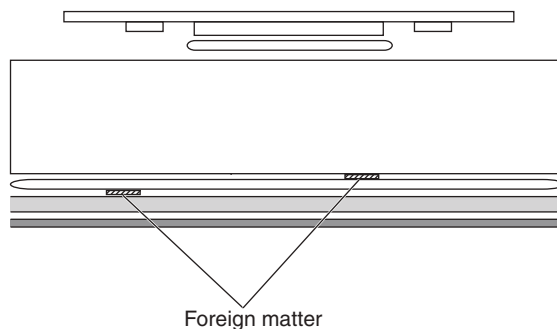

R7000159

Part 8 Appendix

1. Piping Diagrams.....	337
1.1 Indoor Unit.....	337
1.2 Outdoor Unit.....	340
2. Wiring Diagrams.....	344
2.1 Indoor Unit.....	344
2.2 Outdoor Unit.....	349
3. Operation Limit.....	359
4. Refrigerant Leak Detection Sensor Replacement (CMXV models only)	361
5. CMXV Refrigerant Pipe.....	362

1. Piping Diagrams

1.1 Indoor Unit

CTXV07AVJU9, FTXV09/12AVJU9

FTXV15/18AVJU9

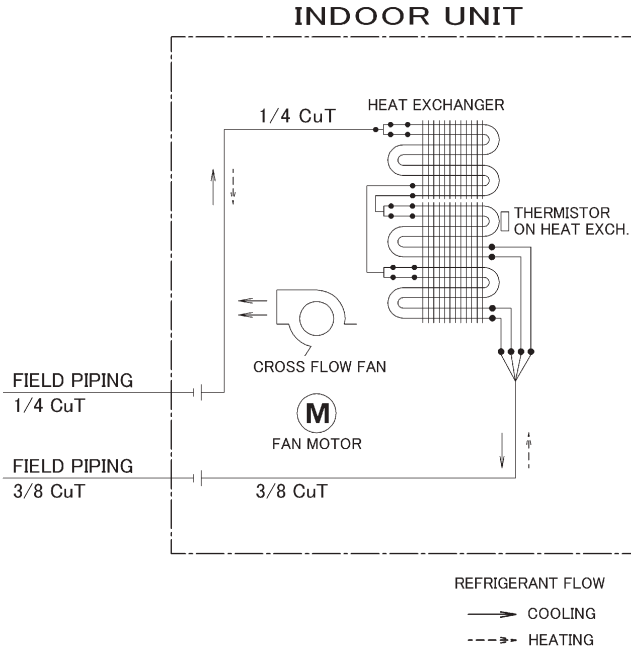

4D150950

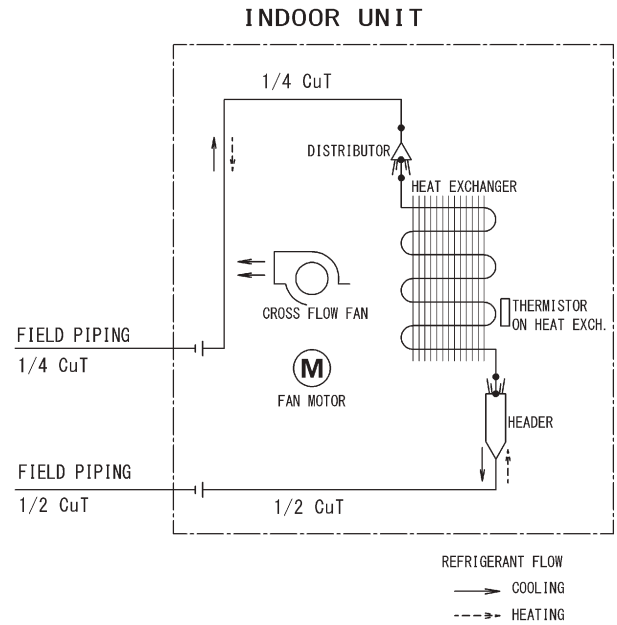

4D091769E

FTXV24AVJU9

CDMA07AVJU9, FDMA09/12/15/18/24AVJU9

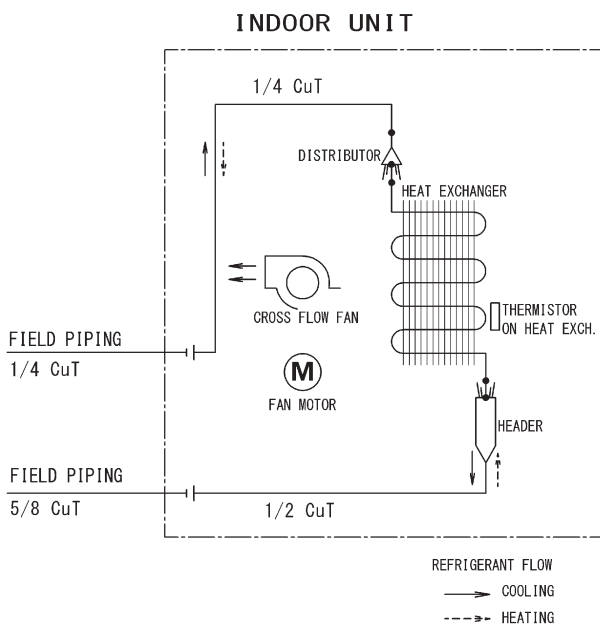

4D091768C

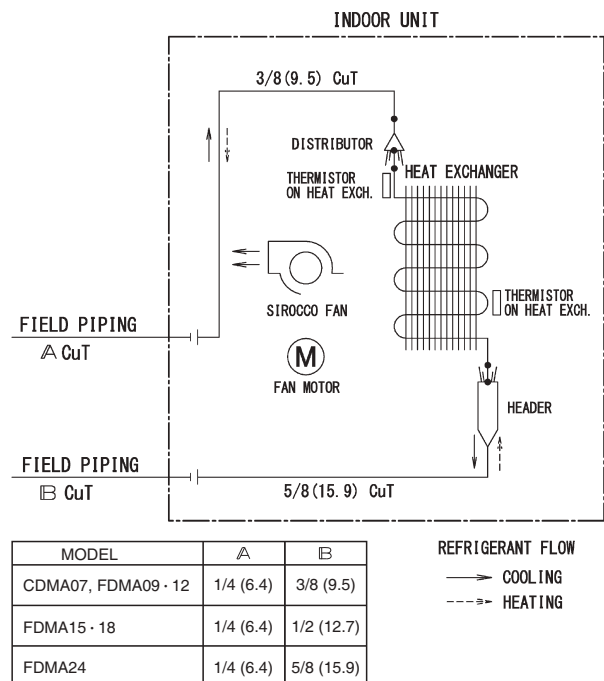

C: 4D112974C

FVXV09/12AVJUW(T)9

FVXV15/18AVJUW(T)9

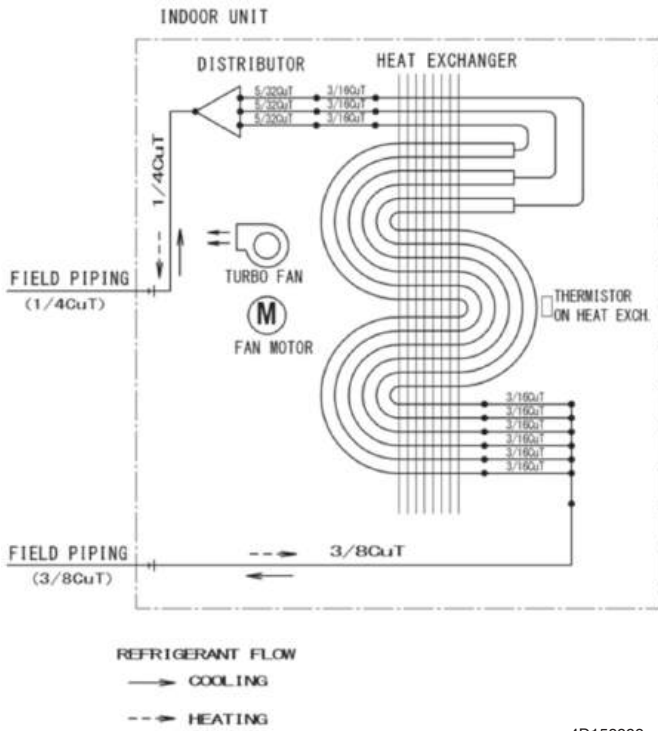

4D158898

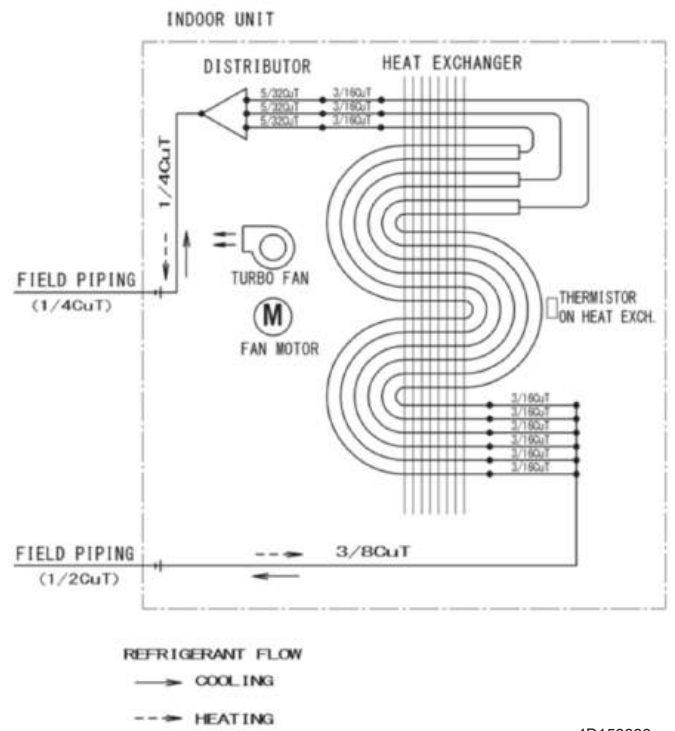

4D158899

CMXV12AVJUA

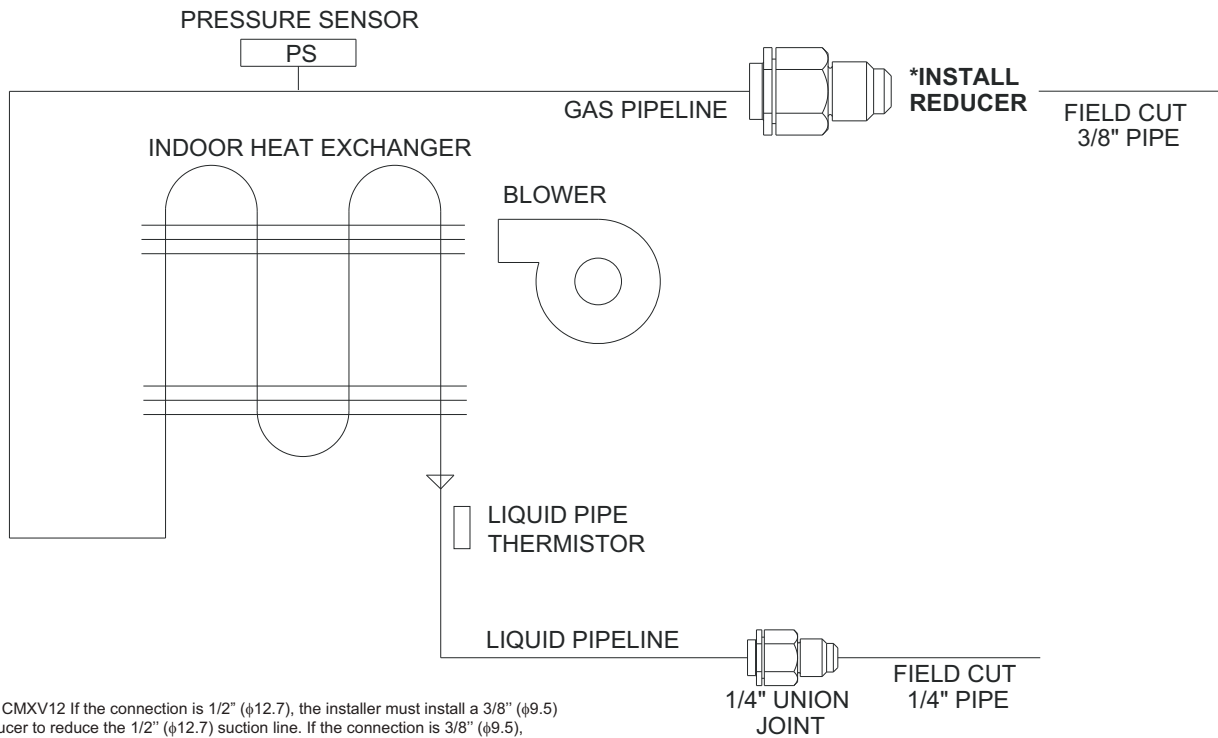

*For CMXV12 if the connection is 1/2" (φ12.7), the installer must install a 3/8" (φ9.5) reducer to reduce the 1/2" (φ12.7) suction line. If the connection is 3/8" (φ9.5), the reducer is not required and should be disregarded

CMXV18AVJUA

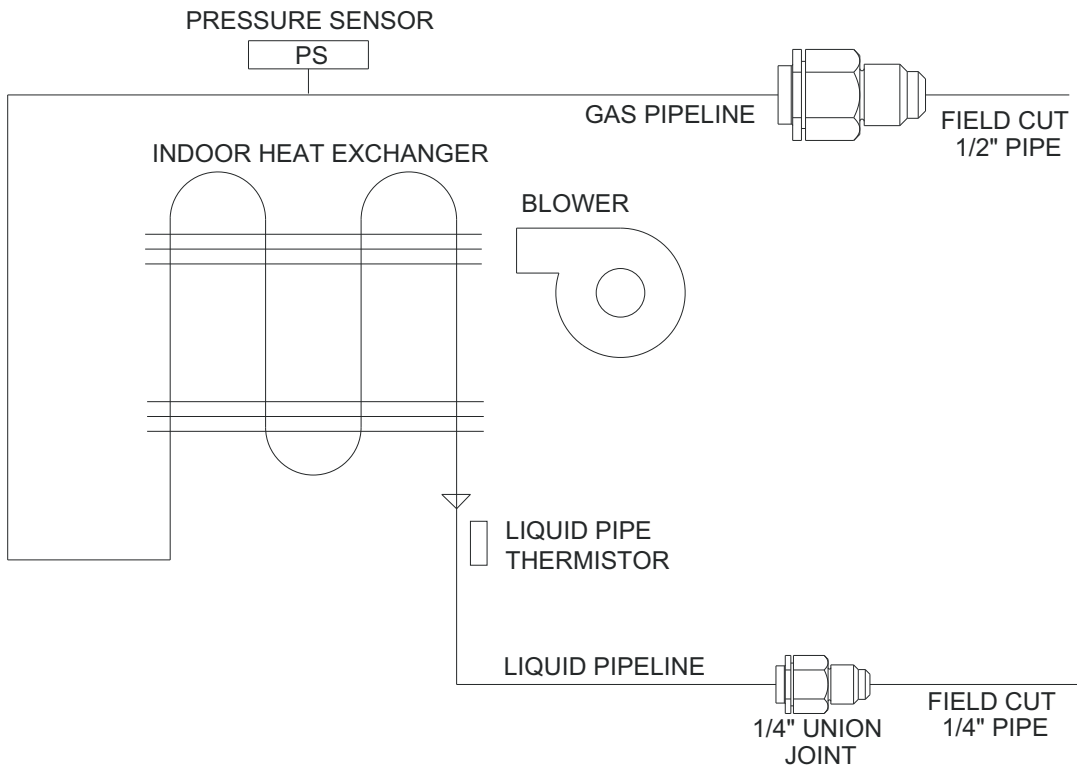

CMXV24AVJUA

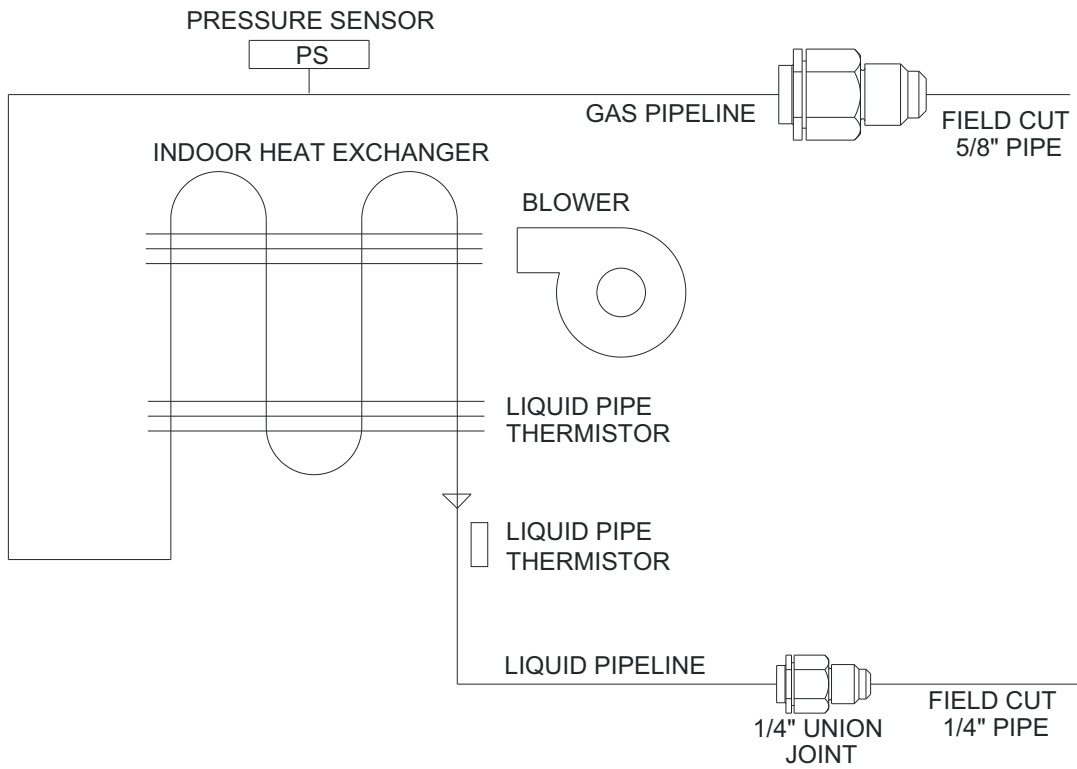

1.2 Outdoor Unit

2MXM18AVJU9(8)

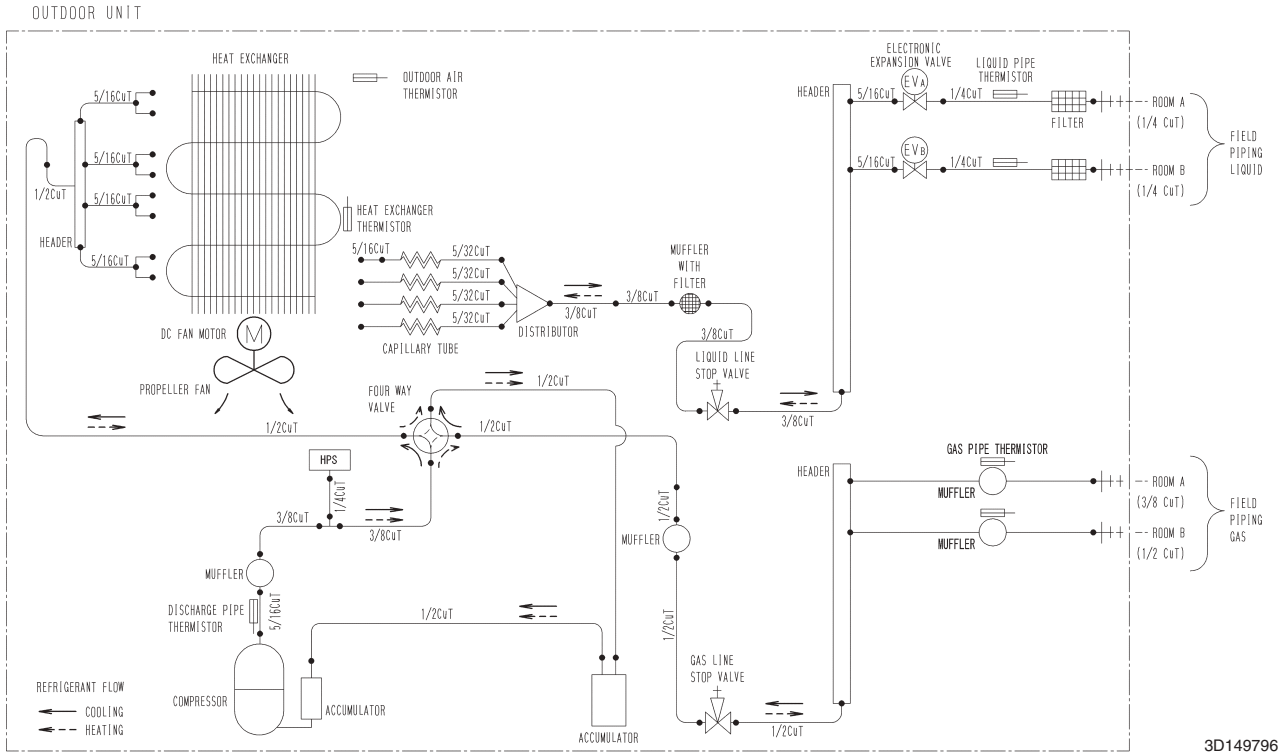

3MXM24AVJU9(8)

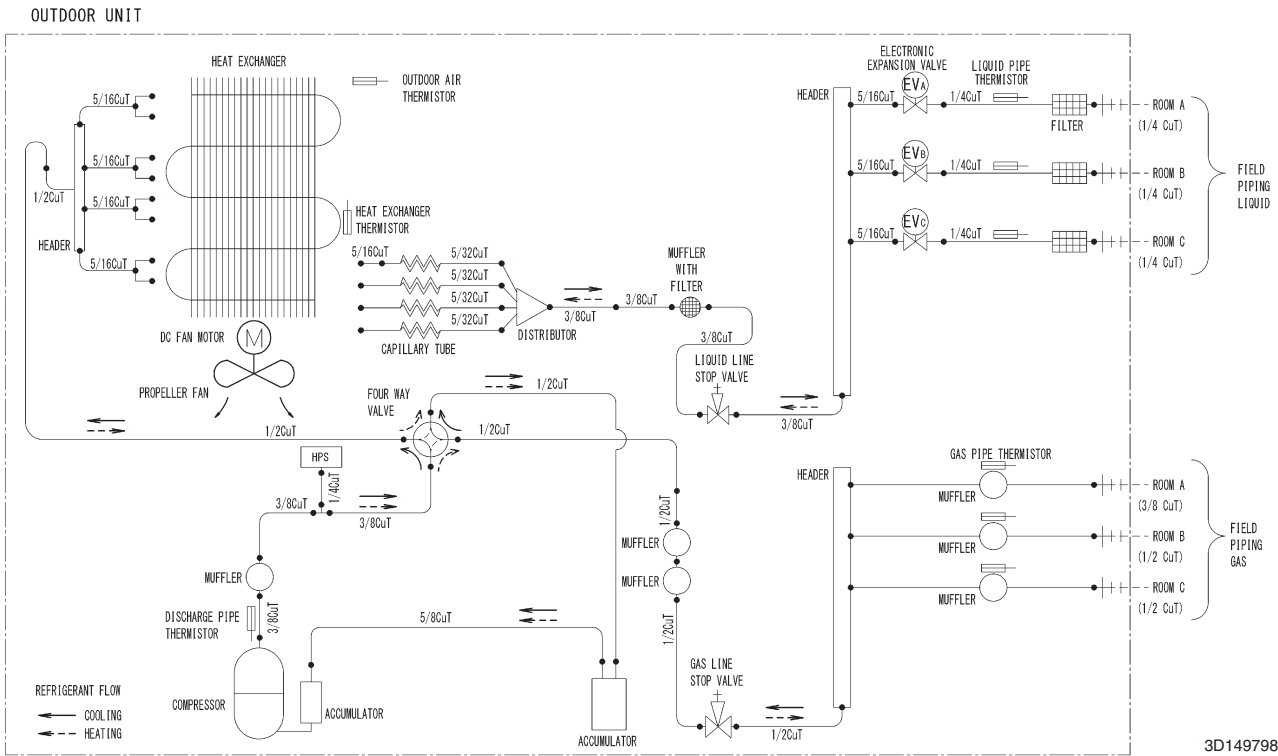

4MXM36AVJU9(8)

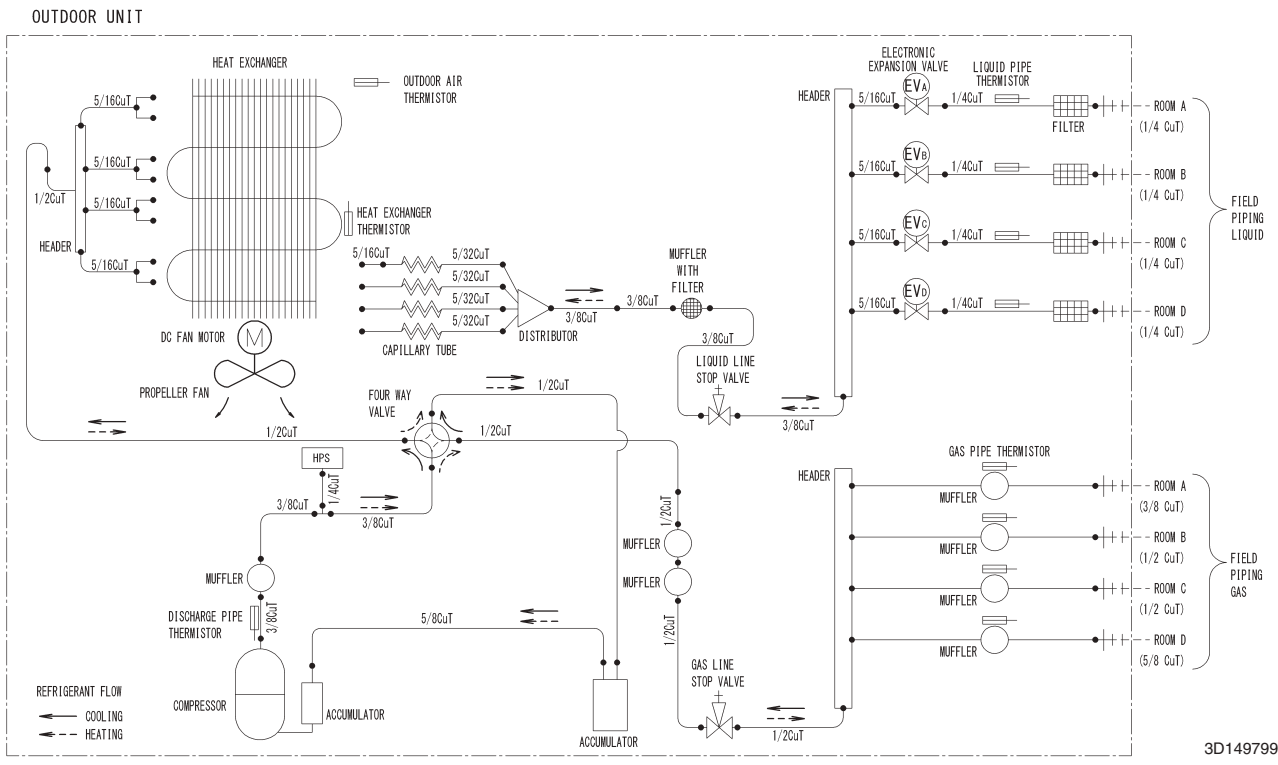

5MXM48AVJU9(8), 5MXT40AVJU9(8), 5MXTH40AVJU9(8)

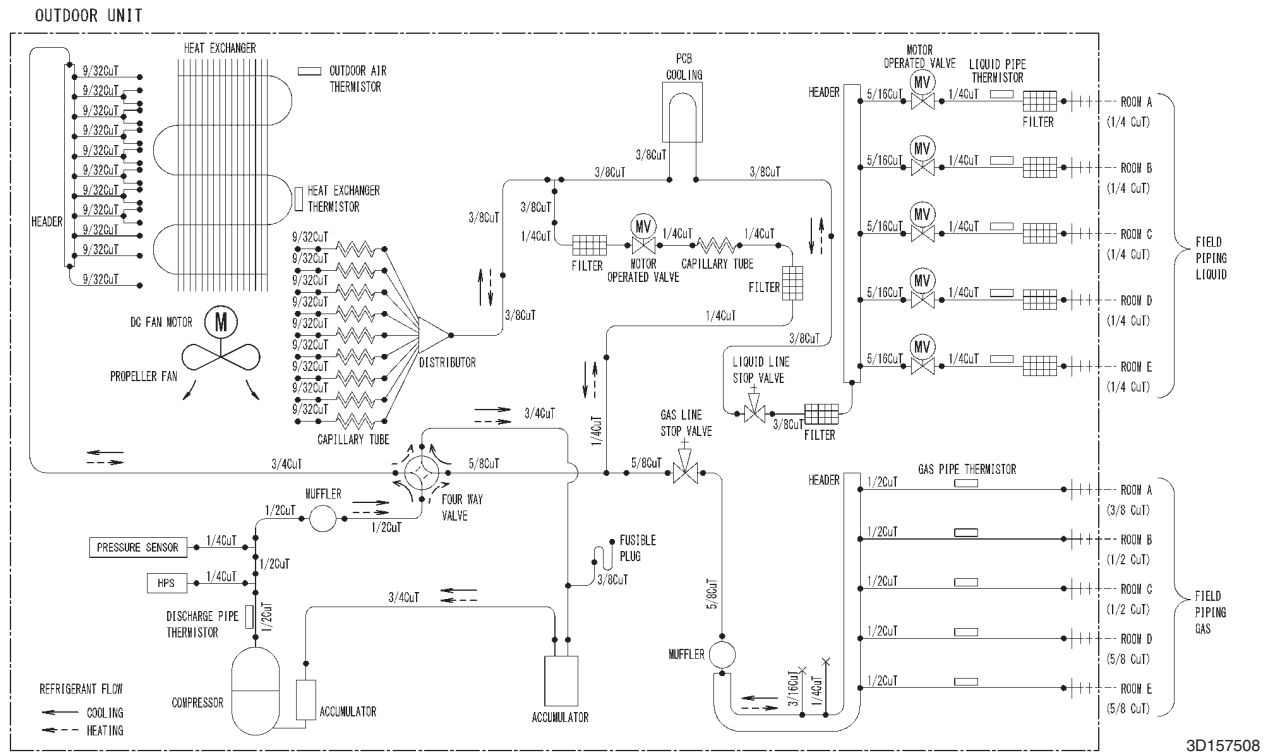

2MXT18AVJU9(8), 2MXTH18AVJU9(8)

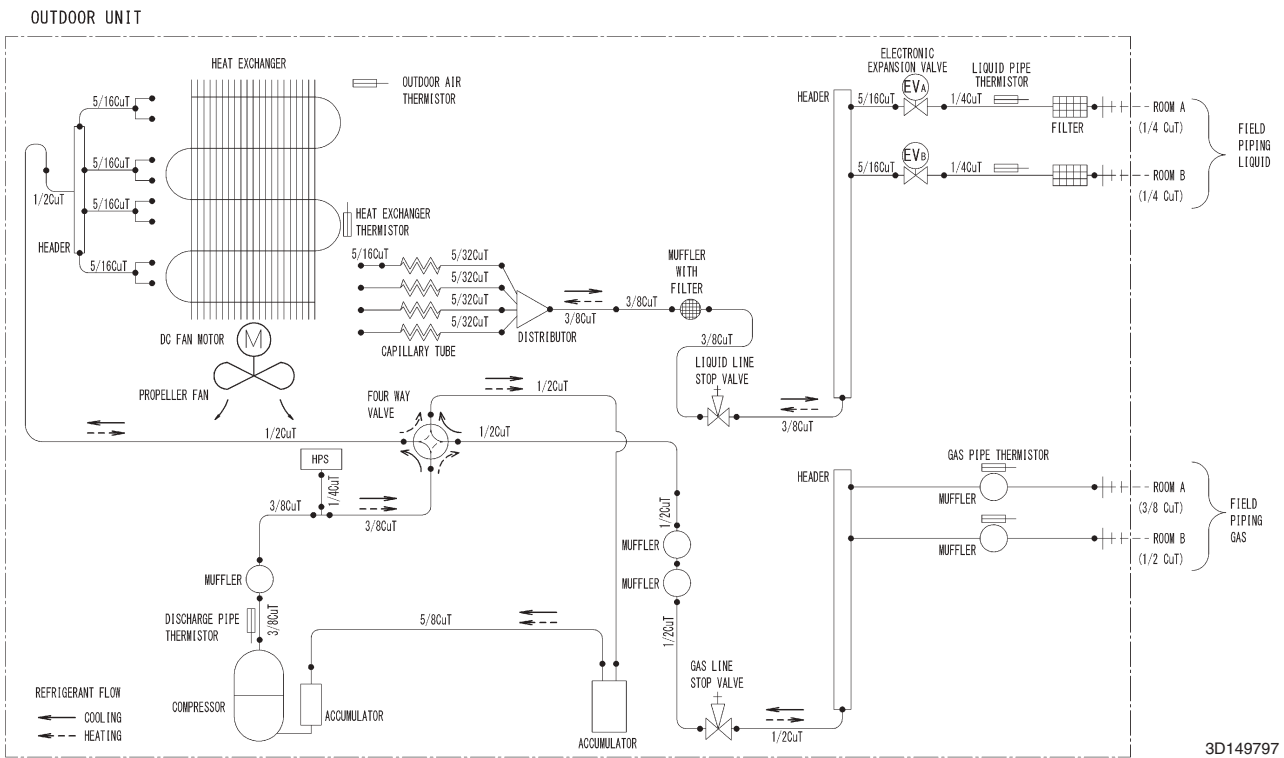

3MXT24AVJU9(8), 3MXTH24AVJU9(8)

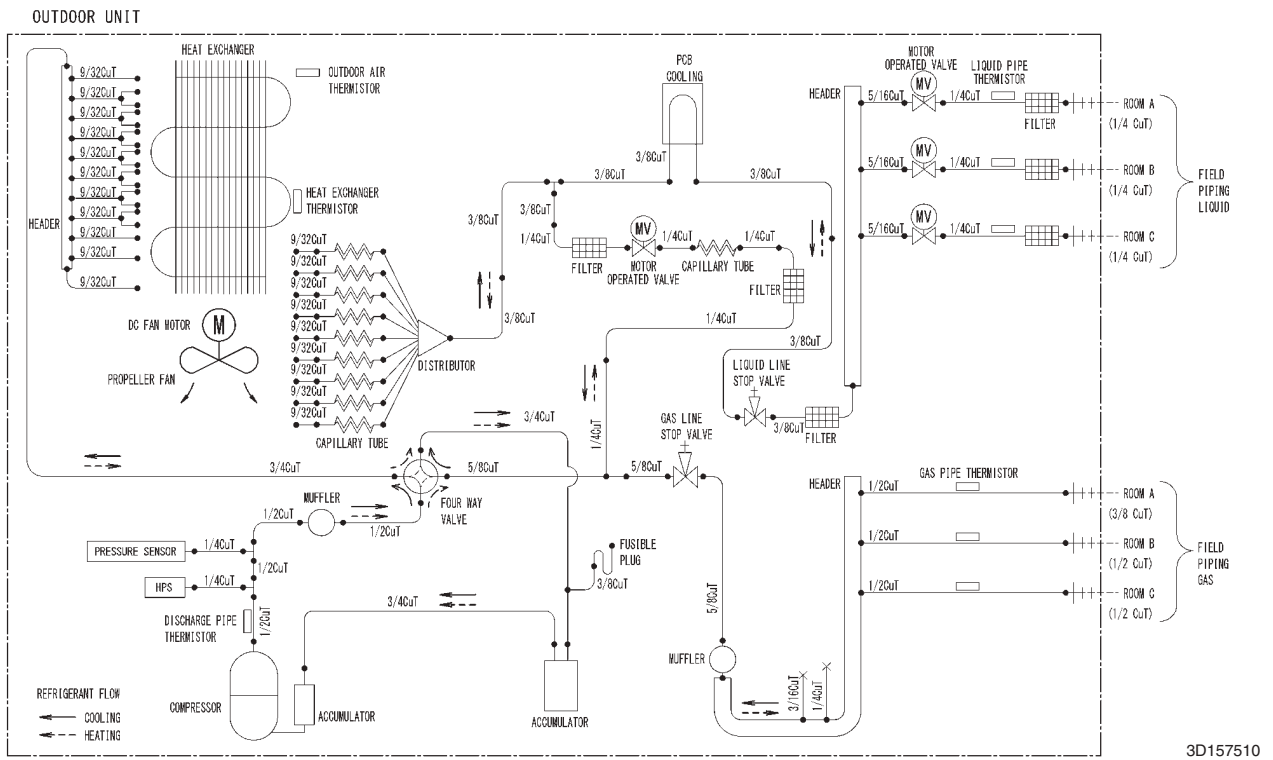

4MXT36AVJU9(8), 4MXTH36AVJU9(8)

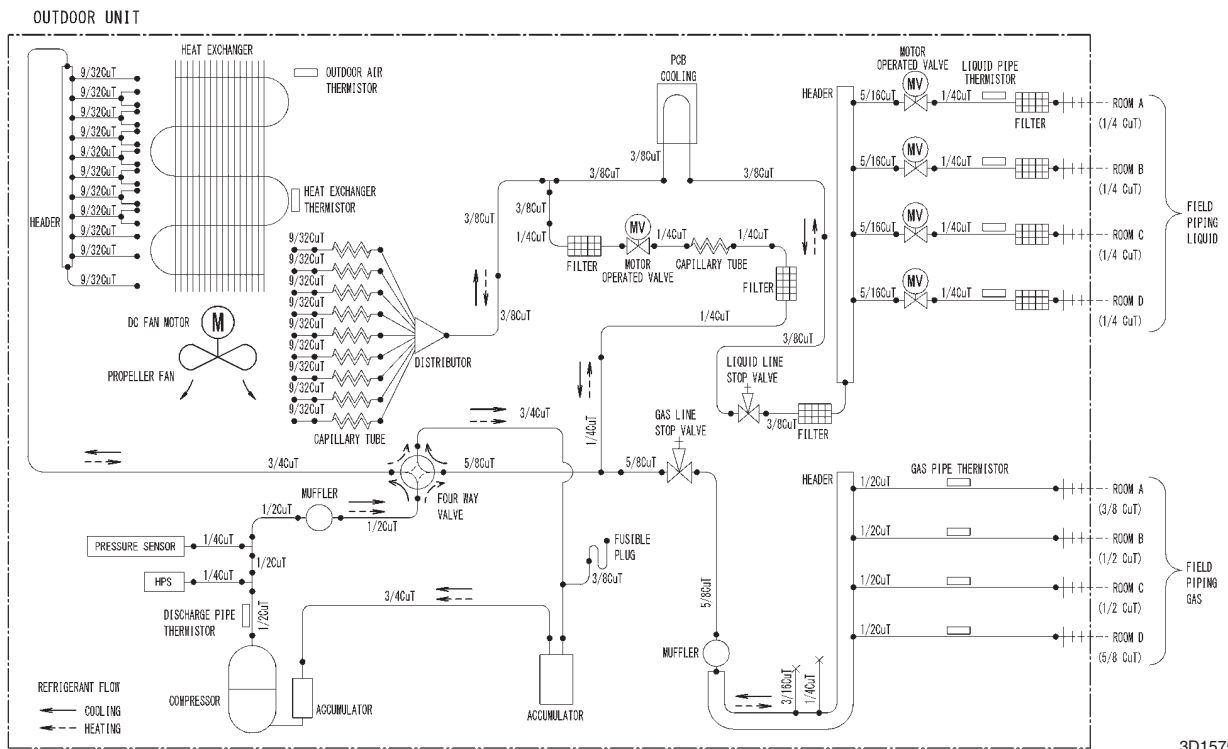

2. Wiring Diagrams

2.1 Indoor Unit

CTXV07AVJU9, FTXV09/12AVJU9

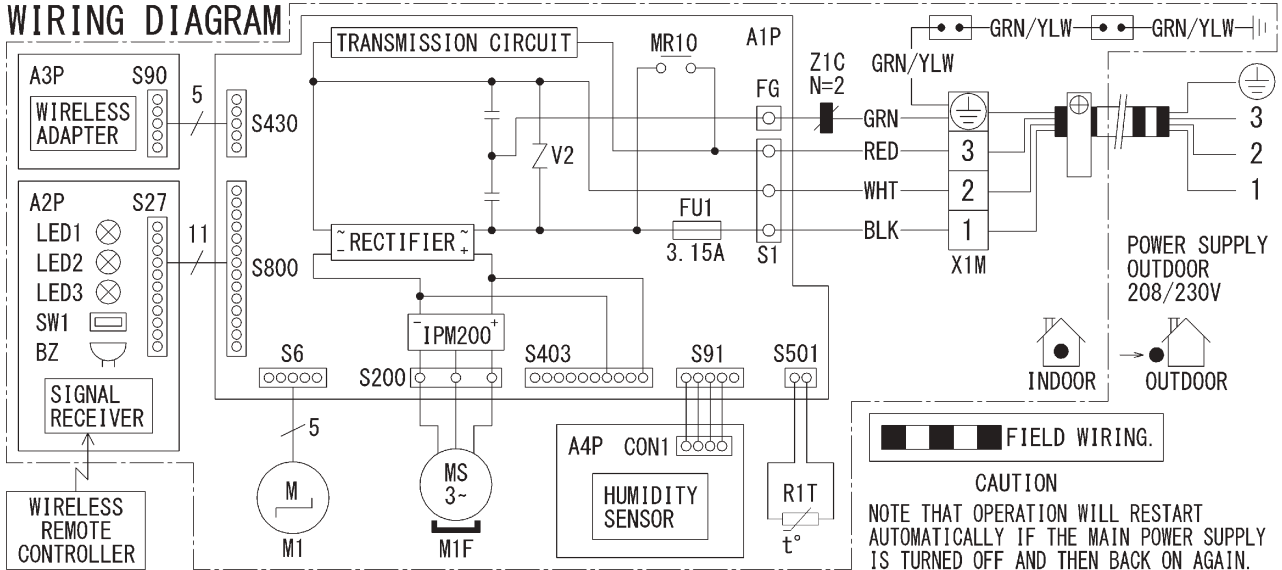

A1P~A4P :PRINTED CIRCUIT BOARD
 BZ :BUZZER
 FG :FRAME GROUND
 FU1 :FUSE
 LED1~LED3 :LIGHT-EMITTING DIODE
 M1F :FAN MOTOR

M1 :SWING MOTOR
 MR10 :RELAY
 R1T :THERMISTOR
 S1~S800, CON1 :CONNECTOR
 SW1 :OPERATION SWITCH

V2 :VARISTOR
 X1M :TERMINAL STRIP
 Z1C :FERRITE CORE
 ⊕ :PROTECTIVE EARTH (GROUND)

CAUTION
 NOTE THAT OPERATION WILL RESTART
 AUTOMATICALLY IF THE MAIN POWER SUPPLY
 IS TURNED OFF AND THEN BACK ON AGAIN.

3D147521A



Note

A1P: Control PCB
 A2P: Display/signal receiver PCB
 A3P: Wireless LAN connection PCB
 A4P: Humidity sensor PCB
 Refer to page 32 for Printed Circuit Board Connector Wiring Diagram.

FTXV15/18/24AVJU9

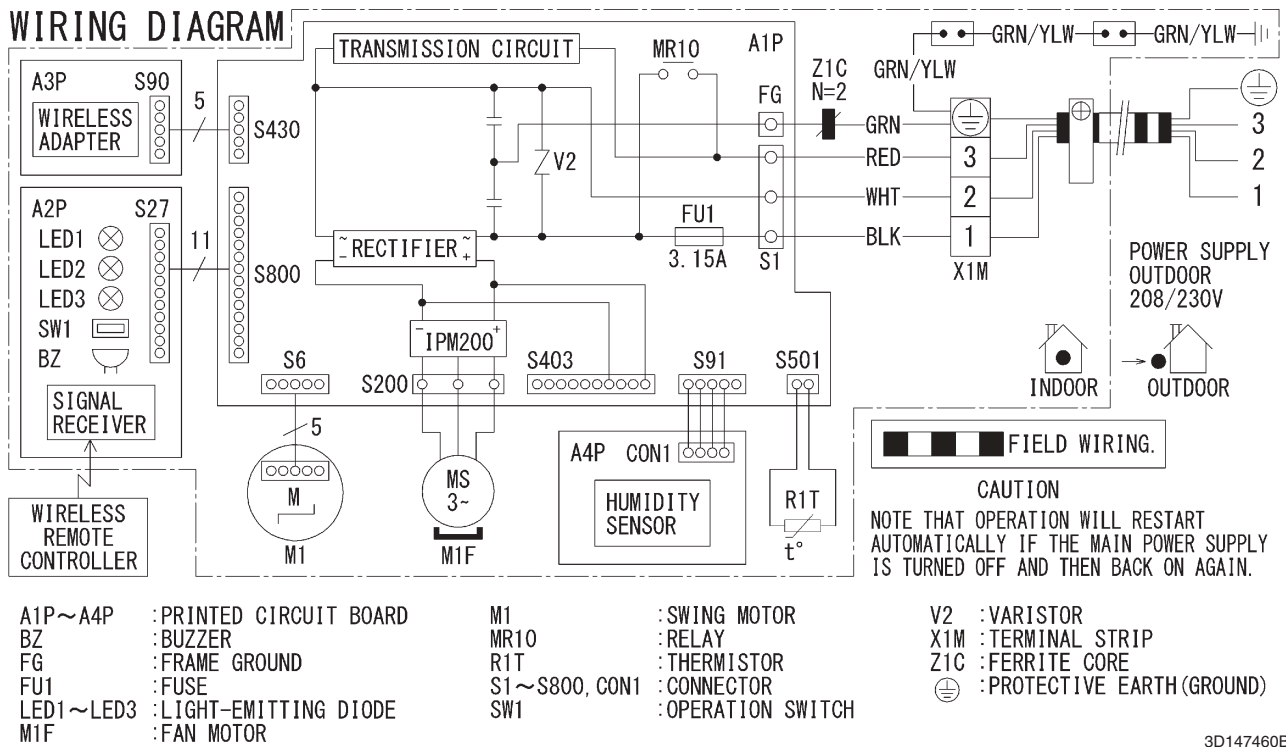

3D147460B



Note

A1P: Control PCB
 A2P: Display/signal receiver PCB
 A3P: Wireless LAN connection PCB
 A4P: Humidity sensor PCB
 Refer to page 32 for Printed Circuit Board Connector Wiring Diagram.

CDMA07AVJU9, FDMA09/12/15/18/24AVJU9

WIRING DIAGRAM

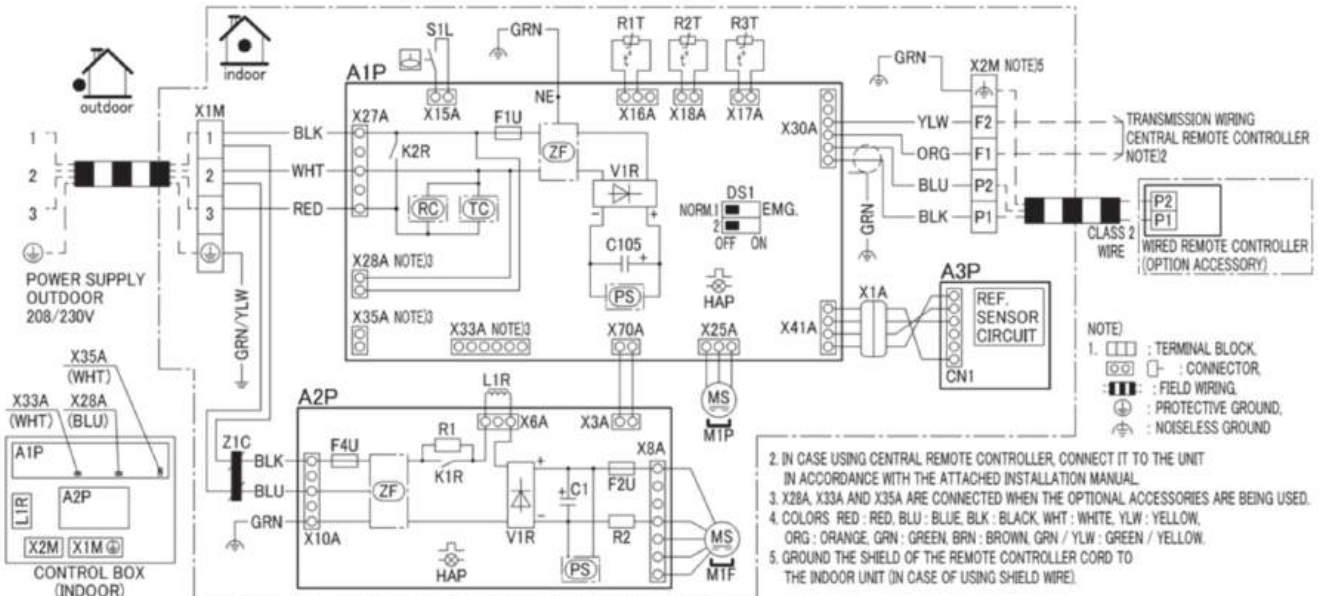

INDOOR UNIT	CONNECTOR OPTIONAL ACCESSORY
A1P PRINTED CIRCUIT BOARD	X28A CONNECTOR (POWER SUPPLY FOR WIRING)
A2P PRINTED CIRCUIT BOARD (FAN)	X33A CONNECTOR (FOR WIRING)
A3P PRINTED CIRCUIT BOARD (REFRIGERANT SENSOR)	X35A CONNECTOR (ADAPTER)
C1 CAPACITOR	
C105 CAPACITOR	
DS1 DIP SWITCH (EMERGENCY)	
F1U FUSE (T, 3.15A, 250V)	
F2U FUSE (T, 5A, 250V)	
F4U FUSE (T, 6.3A, 250V)	
HAP PILOT LAMP (SERVICE MONITOR-GREEN)	
K1R MAGNETIC RELAY	
K2R MAGNETIC RELAY	
L1R REACTOR	
M1F MOTOR (FAN INDOOR)	
M1P MOTOR (DRAIN PUMP)	
R1 RESISTOR (CURRENT LIMITING)	
R2 CURRENT SENSING DEVICE	
R1T THERMISTOR (SUCTION AIR)	
R2T THERMISTOR (HEAT EXCHANGER)	
R3T THERMISTOR (HEAT EXCHANGER)	
S1L FLOAT SWITCH	
V1R DIODE BRIDGE	
X1M TERMINAL BLOCK (POWER SUPPLY)	
X2M TERMINAL BLOCK (CONTROL)	
ZF NOISE FILTER	
Z1C FERRITE CORE	
PS SWITCHING POWER SUPPLY	
RC RECEIVER	
TC TRANSMITTER	

i Notes

- A1P: Control PCB
- A2P: Indoor fan PCB
- A3P: Refrigerant sensor PCB
- Refer to page 34 for Printed Circuit Board Connector Wiring Diagram.

3D157107

FVXV09/12/15/18AVJUW(T)9

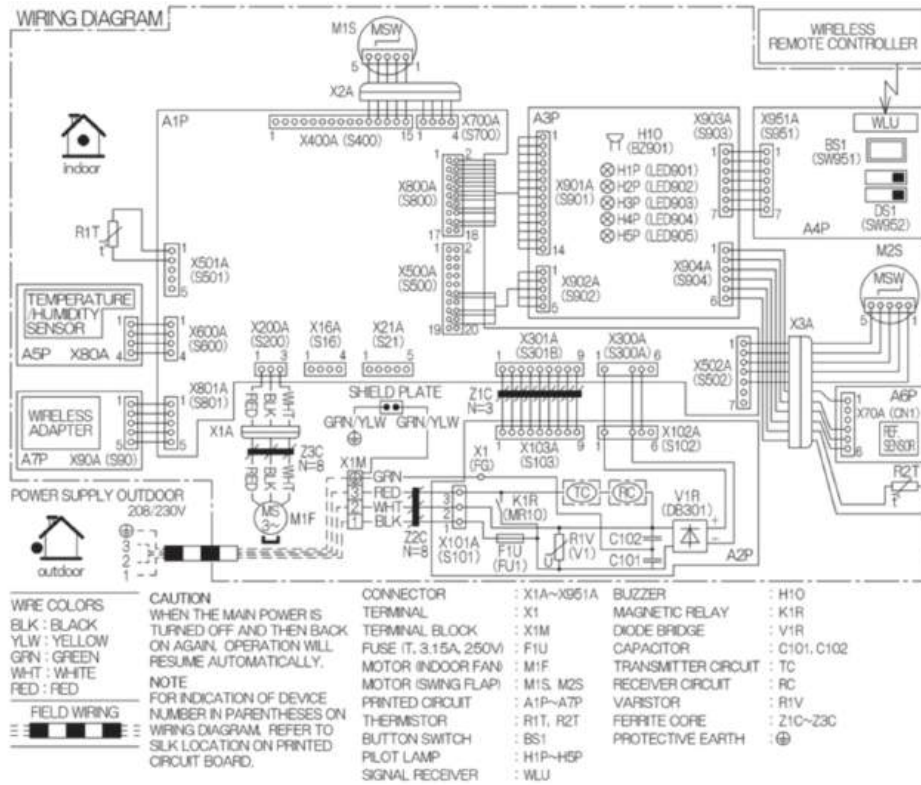

3D157789B



Note(s)

- A1P: Control PCB
 - A2P: Power supply PCB
 - A3P: Display PCB
 - A4P: Signal receiver PCB
 - A5P: Humidity sensor PCB
 - A6P: Refrigerant sensor PCB
 - A7P: Wireless LAN connection PCB
- Refer to page 36 for Printed Circuit Board Connector Wiring Diagram.

CMXV12/18/24AVJUA

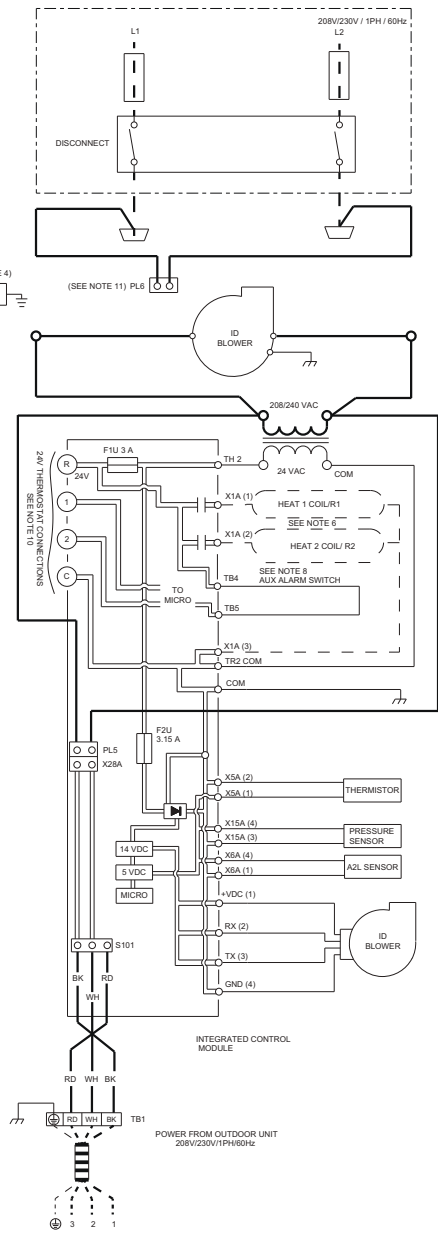
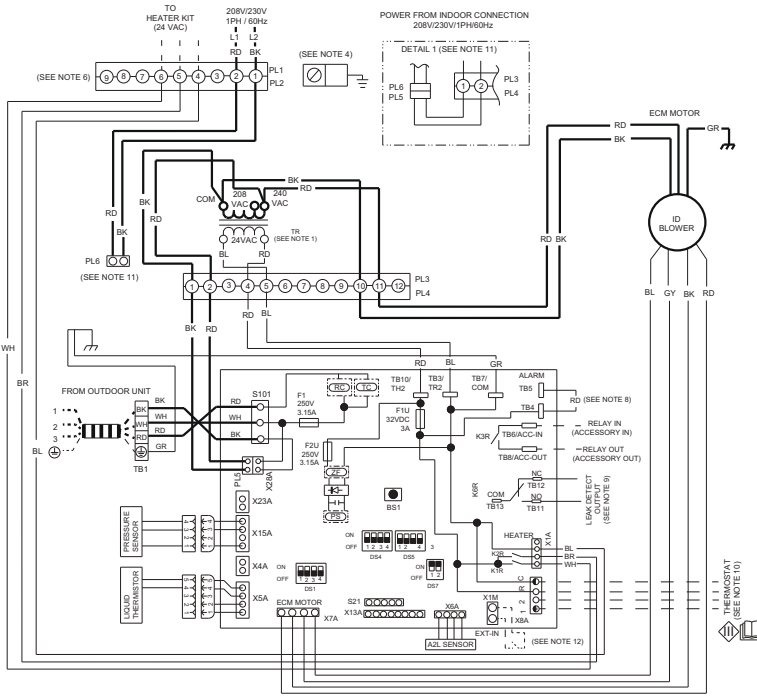

NOTES:

- FOR INSTALLATIONS USING 208V SUPPLY POWER, MOVE PRIMARY CONNECTIONS FROM THE 240V TAP TO THE 208V TAP.
- MANUFACTURER'S SPECIFIED REPLACEMENT PARTS MUST BE USED WHEN SERVICING.
- IF ANY OF THE ORIGINAL WIRES AS SUPPLIED WITH THIS UNIT MUST BE REPLACED, IT MUST BE REPLACED WITH WIRING MATERIAL HAVING A TEMPERATURE RATING OF AT LEAST 105°C. USE COPPER CONDUCTORS ONLY.
- UNIT MUST BE PERMANENTLY GROUNDING AND CONFORM TO N.E.C. AND LOCAL CODES.
- RED STATUS LED PROVIDES NETWORK STATUS. GREEN RX LED INDICATES NETWORK TRAFFIC. USE LEARN BUTTON TO RESET NETWORK.
- DISCARD FACTORY INSTALLED CONNECTOR PL1 AND REPLACE WITH THE HEATER KIT WIRING HARNESS CONNECTOR WHEN INSTALLING OPTIONAL ELECTRIC HEATER KIT.
- THE POSITION OF SELECTOR SWITCHES (DS1 - DS7) INDICATE FACTORY SETTING.
- REMOVE SHORT RED JUMPER WIRE AND PUT AUX ALARM SWITCH WHEN INSTALLING NORMALLY CLOSED DRY CONTACT SWITCH, CONDENSATE SWITCH, ETC.
- THIS OUTPUT (K6R RELAY) OPERATES WHEN A REFRIGERANT LEAK IS DETECTED. (DRY CONTACT) USE THIS CONTACT WHEN INTERLOCKING UV LIGHT, DAMPER, VENTILATION ETC.
- USE N.E.C. CLASS 2 WIRE.
- WHEN OUTDOOR POWER IS INSUFFICIENT FOR THE OPERATING OF ALL INDOOR COMPONENTS, DISCONNECT PL5 FROM X28A AND CONNECT PL5 TO PL6. POWER MUST BE CONNECTED THROUGH PL1 LEAD WIRES OR THROUGH THE HEATER KIT WIRE HARNESS. SEE IO MANUAL FOR ADDITIONAL INFORMATION.
- CONNECT TO HUMIDIFIER SIGNAL.

COMPONENT LEGEND:

- LOW VOLTAGE
- LOW VOLTAGE FIELD
- HIGH VOLTAGE
- HIGH VOLTAGE FIELD
- JUNCTION
- TERMINAL
- INTERNAL CONNECTIONS
- RESISTOR
- FUSE (F1U, F2U, F1)
- PLUG CONNECTION
- EQUIPMENT GROUND
- FIELD GROUND
- DIP SWITCH(OFF)
- FIELD SPLICE
- CLASS III
- SLEEVE

COMPONENT CODES:

- PL1, PL2 — POWER/HEATER CONNECTOR
 - PL3, PL4 — TRANSFORMER CONNECTOR
 - PL5 — PCB POWER TO TRANSFORMER /BLOWER
 - PL6 — INDOOR POWER (WHEN REQUIRED)
 - DS1-DS7 — SELECTOR SWITCH
 - TR — TRANSFORMER
 - ID — INDOOR
 - AUX — AUXILIARY
 - COM — 24V COMMON
 - BS1 — FAULT RECALL BUTTON
 - TB1 — TERMINAL BLOCK
- COLOR CODES:**
- BL - BLUE
 - RD - RED
 - YL - YELLOW
 - OR - ORANGE
 - BK - BLACK
 - GY - GREY
 - BR - BROWN
 - GR - GREEN
 - PU - PURPLE
 - WH - WHITE



Note(s)

A1P: Control PCB

Refer to page 40 for Printed Circuit Board Connector Wiring Diagram.

0140A20115

3MXM24AVJU9(8)

WIRING DIAGRAM

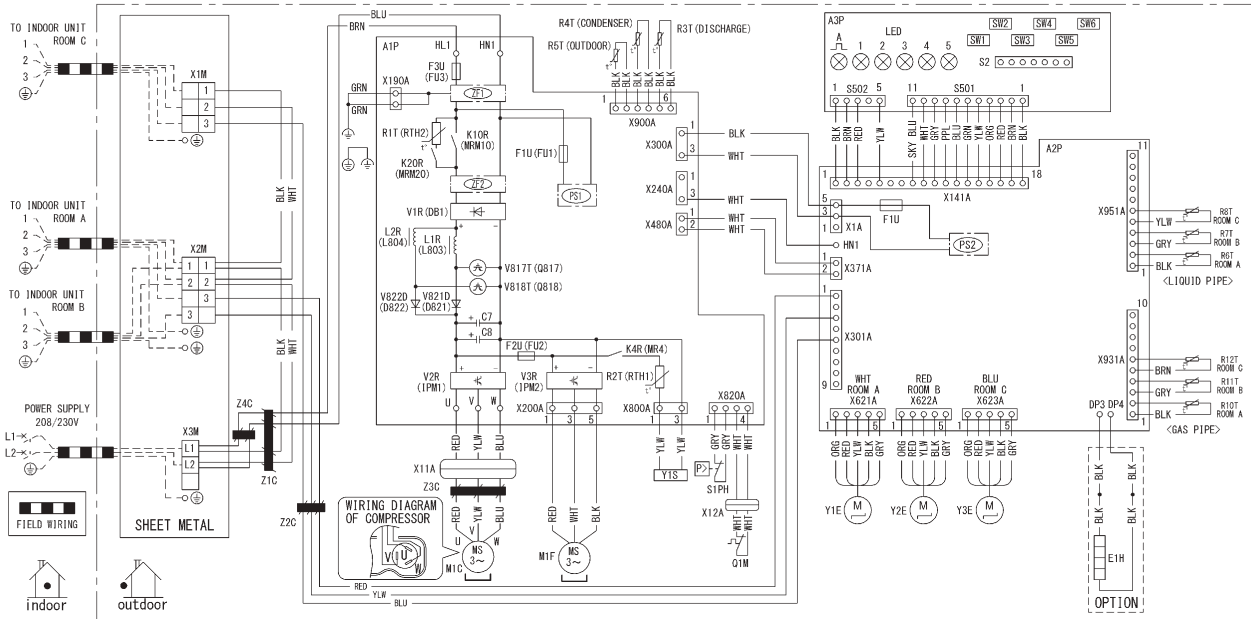

- | | | | | | | | |
|--|-------------------------|----------|-----------------------------------|--------------------|-------------------------------|----------|-----------------------------------|
| A1P~A3P | : PRINTED CIRCUIT BOARD | M1C | : COMPRESSOR MOTOR | SW3 | : WIRING ERROR CHECK SW | X1M~X3M | : TERMINAL BLOCK |
| C7, C8 | : CAPACITOR | M1F | : FAN MOTOR | SW4 | : PRIORITY ROOM SETTING SW | Y1E~Y3E | : ELECTRONIC EXPANSION VALVE COIL |
| DPS, DPA, HLI, HNI (A1P), HNI (A2P), U, V, W | : TERMINAL | PS1, PS2 | : SWITCHING POWER SUPPLY | SW5 | : FUNCTION SW | Z1C~Z4C | : FERRITE CORE |
| E1H | : HEATER | Q1M | : OVERLOAD PROTECTOR | SW6 | : NIGHT QUIET MODE SETTING SW | ZF1, ZF2 | : NOISE FILTER |
| F1U (A1P), F2U, F3U, F1U (A2P) | : FUSE | R1T~R12T | : THERMISTOR | S2~S502, X1A~X951A | : CONNECTOR | ⊕ | : PROTECTIVE GROUND |
| K4R, K10R, K20R | : MAGNETIC RELAY | S1PH | : HIGH PRESSURE SWITCH | V1R | : DIODE BRIDGE | ⚡ | : NOISELESS GROUND |
| L1, L2 | : LIVE | SW | : TERMINAL BLOCK FIXED PLATE | V2R, V3R | : INTELLIGENT POWER MODULE | | |
| L1R, L2R | : REACTOR | SW1 | : FORCED OPERATION ON/OFF SW | V817T, V818T | : LED | | |
| LED1~5, LEDA | : PILOT LAMP | SW2 | : FORCED OPERATION MODE SELECT SW | V821D, V822D | : DIODE | | |

C: 3D149180



Note(s)

- A1P: Main PCB
- A2P: Sub PCB
- A3P: Service monitor PCB
- Refer to page 41 for Printed Circuit Board Connector Wiring Diagram.

4MXM36AVJU9(8)

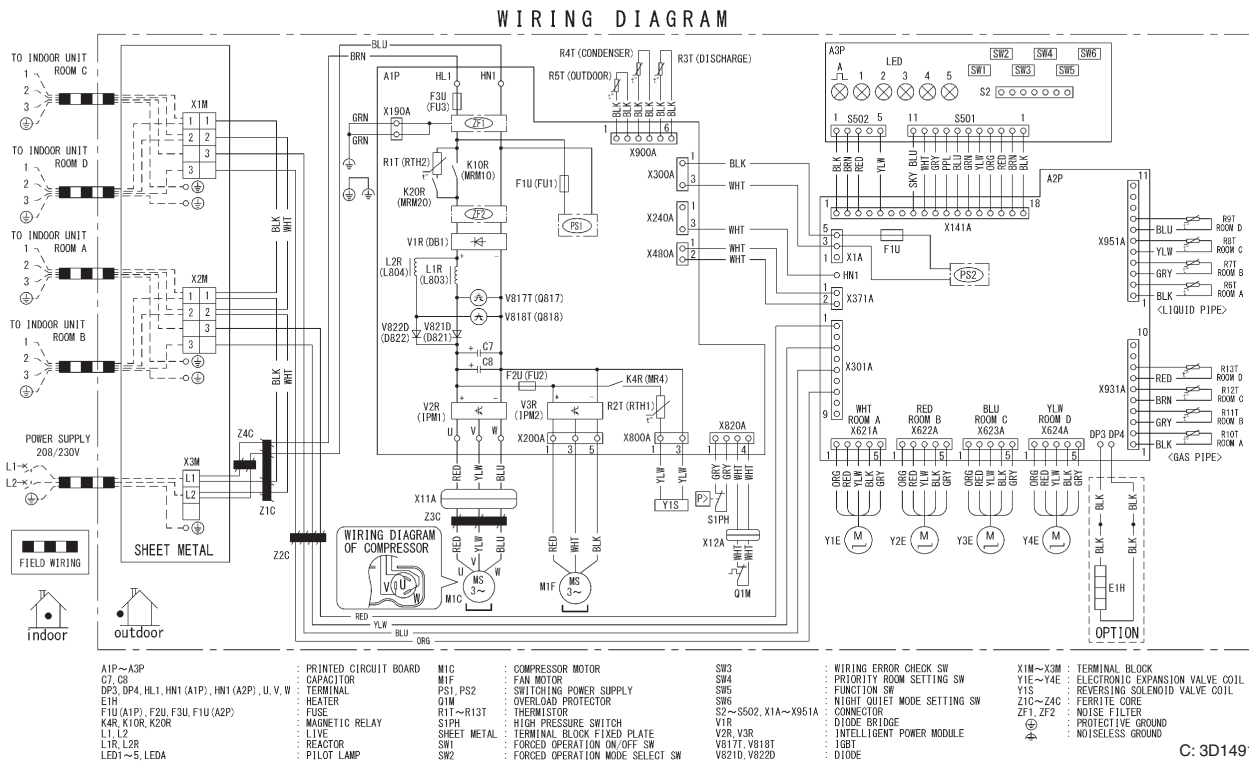

Note(s)

- A1P: Main PCB
- A2P: Sub PCB
- A3P: Service monitor PCB
- Refer to page 41 for Printed Circuit Board Connector Wiring Diagram.

5MXM48AVJU9(8), 5MXT40AVJU9(8)

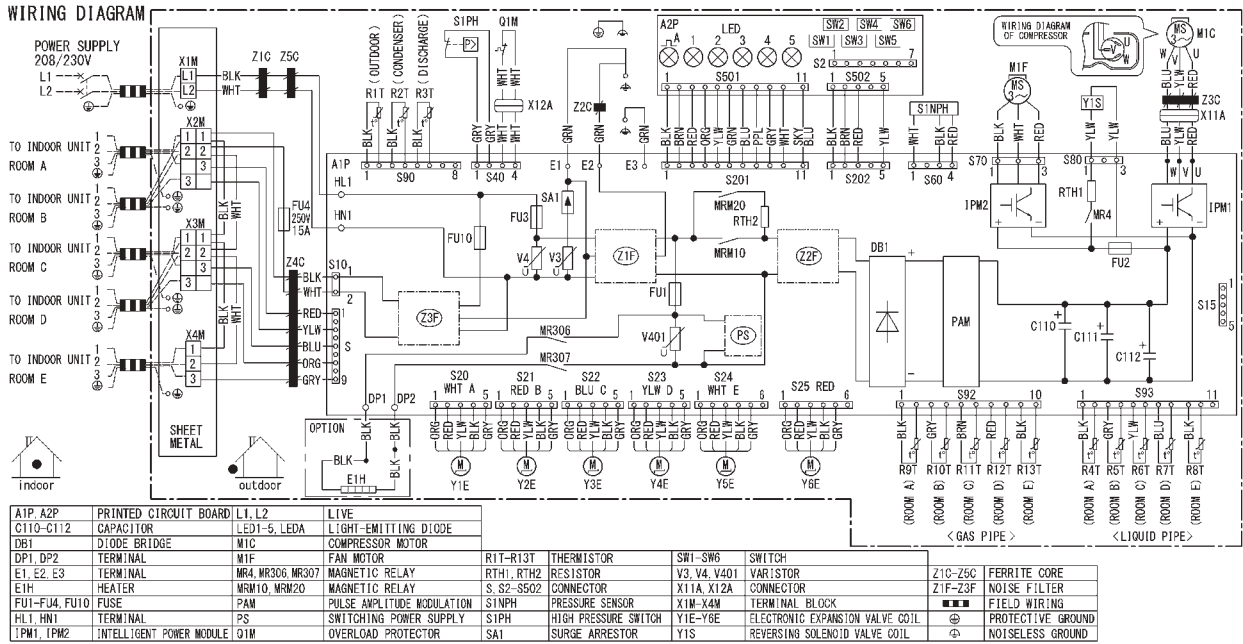

C: 3D156355



Note(s)

- A1P: Main PCB
- A2P: Service monitor PCB
- Refer to page 44 for Printed Circuit Board Connector Wiring Diagram.

2MXTH18AVJU9(8)

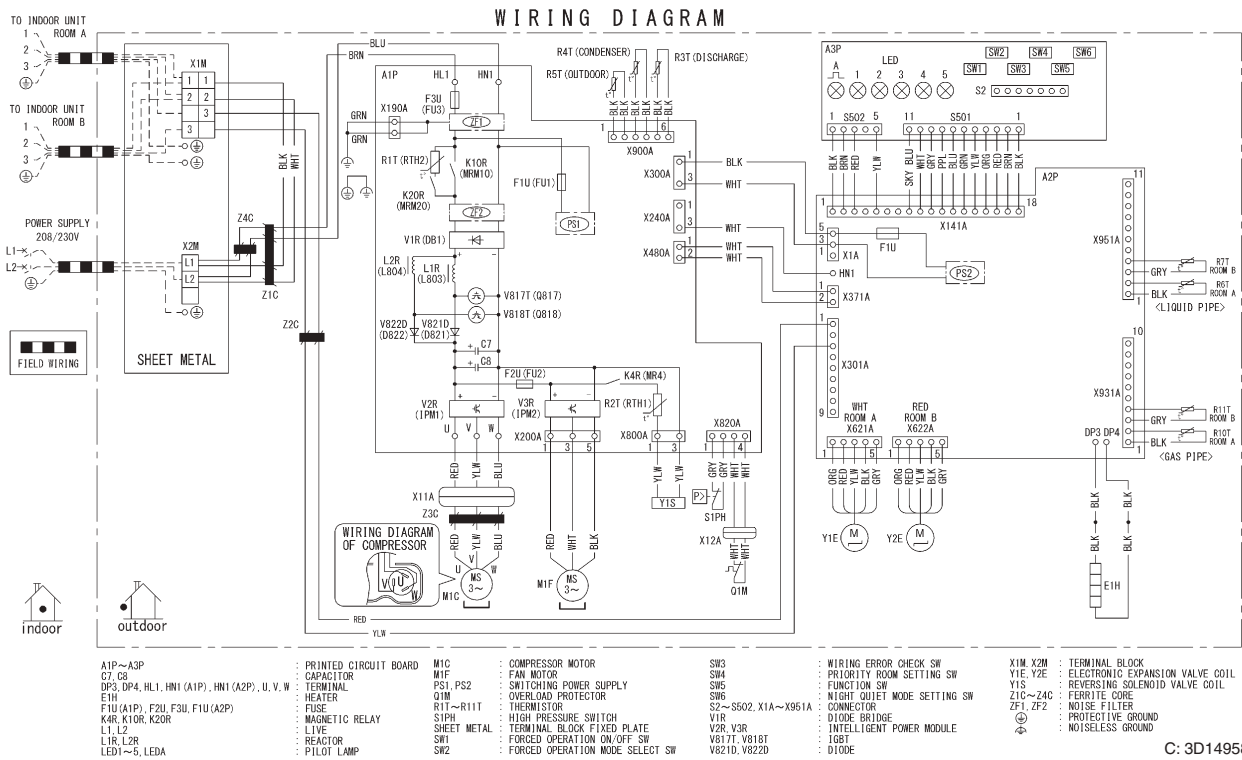

Note(s)

- A1P: Main PCB
- A2P: Sub PCB
- A3P: Service monitor PCB
- Refer to page 41 for Printed Circuit Board Connector Wiring Diagram.

3MXT24AVJU9(8)

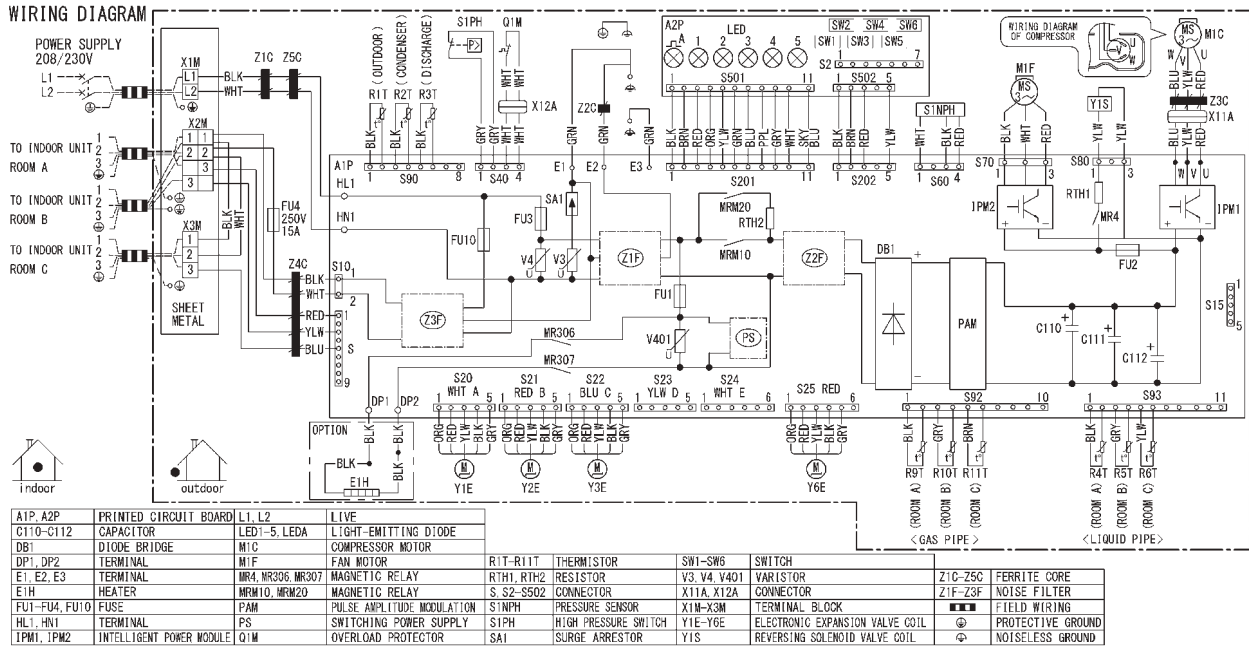

C: 3D156320



Note(s)

- A1P: Main PCB
- A2P: Service monitor PCB
- Refer to page 44 for Printed Circuit Board Connector Wiring Diagram.

3MXTH24AVJU9(8)

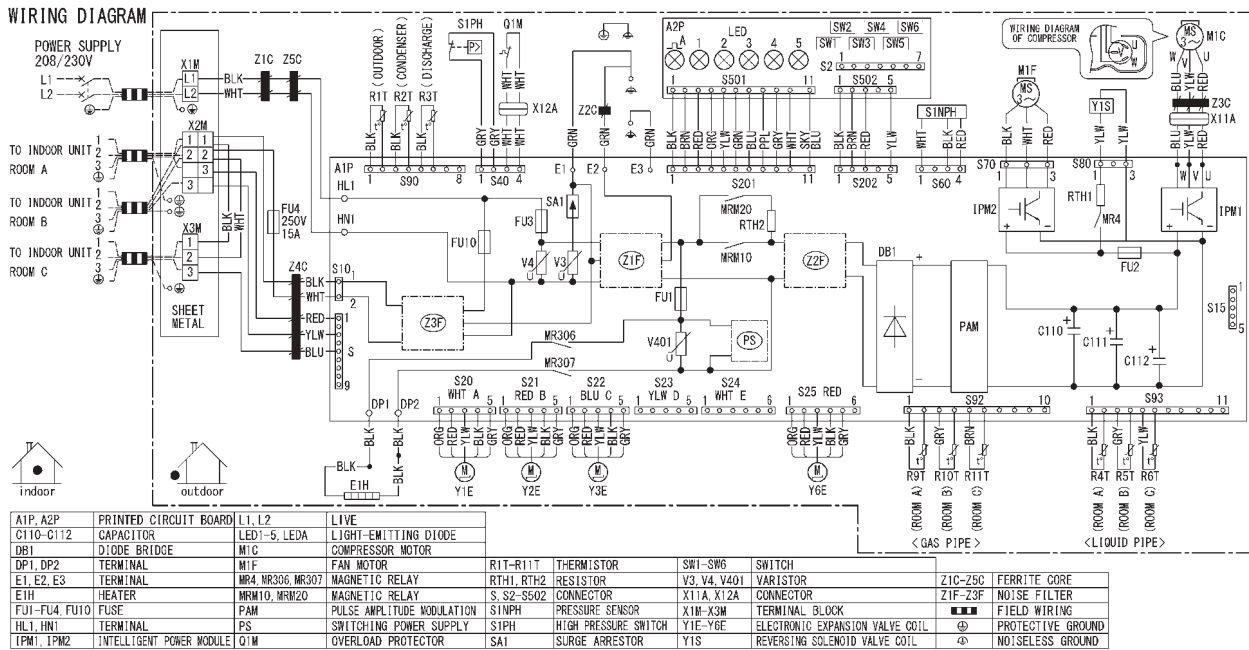

C: 3D156321



Note(s)

- A1P: Main PCB
- A2P: Service monitor PCB
- Refer to page 44 for Printed Circuit Board Connector Wiring Diagram.

4MXTH36AVJU9(8)

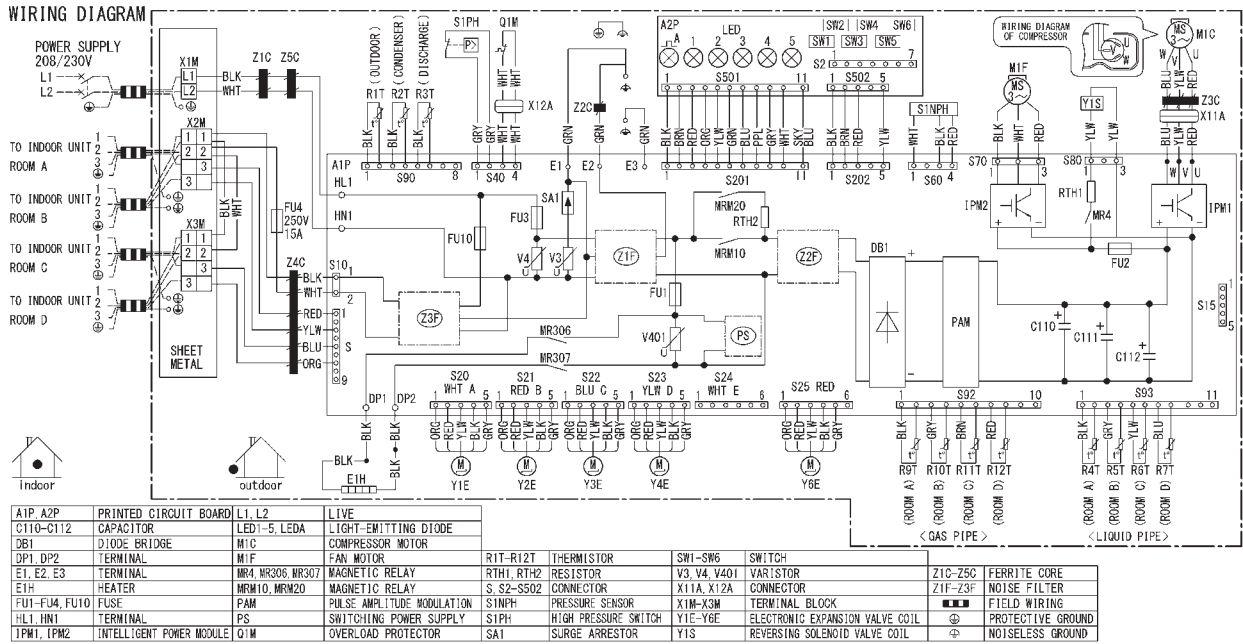

C: 3D156354



Note(s)

- A1P: Main PCB
- A2P: Service monitor PCB
- Refer to page 44 for Printed Circuit Board Connector Wiring Diagram.

5MXTH40AVJU9(8)

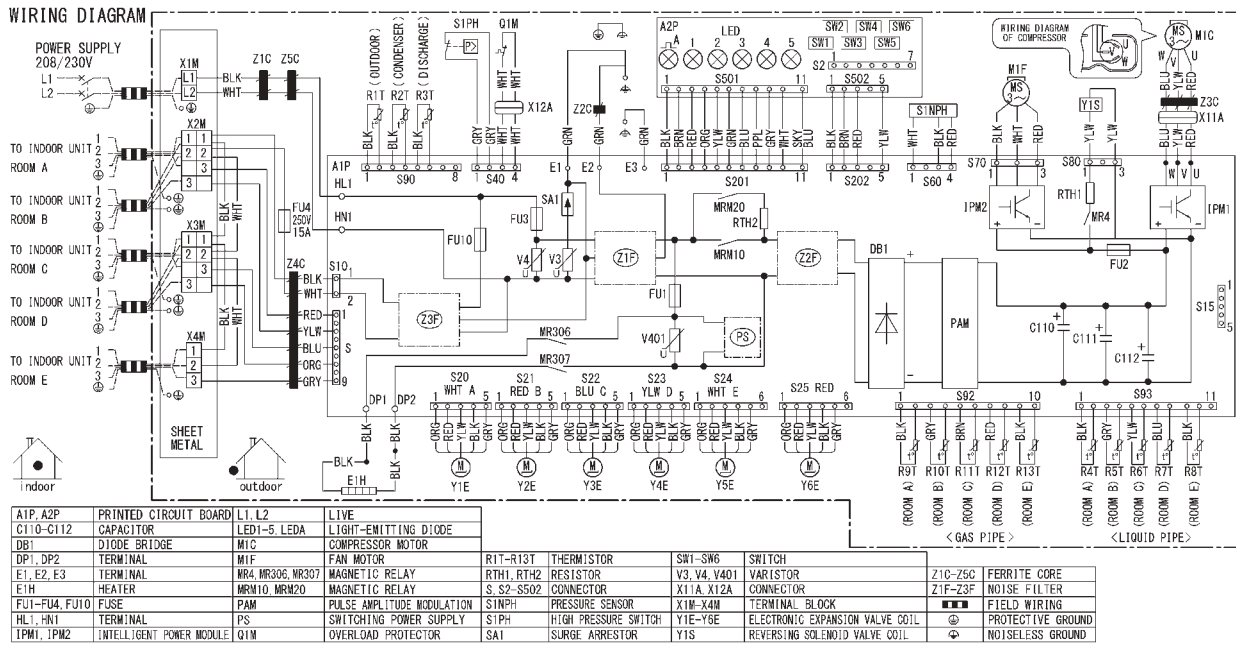

3. Operation Limit

2MXM18AVJU9(8), 3MXM24AVJU9(8), 4MXM36AVJU9(8)

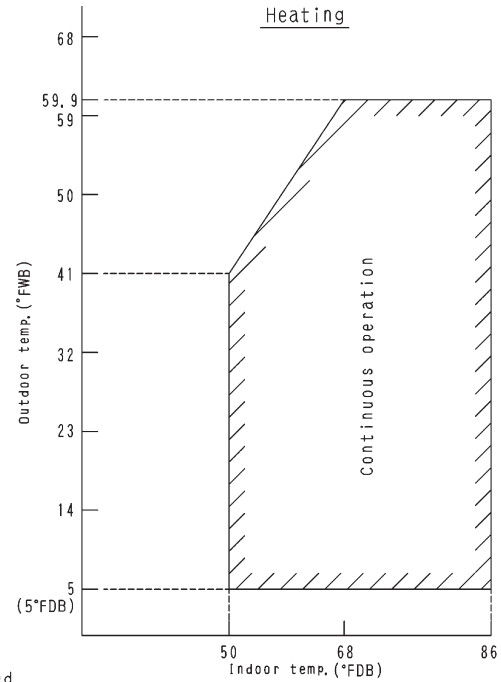
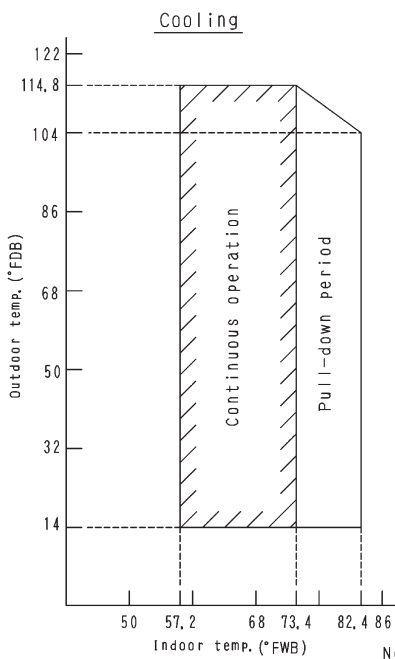

Notes:
 The graphs are based on the following conditions.
 • Equivalent piping length 25ft
 • Level difference 0ft
 • Air flow rate High

3D048149D

2MXT18AVJU9(8), 2MXTH18AVJU9(8)

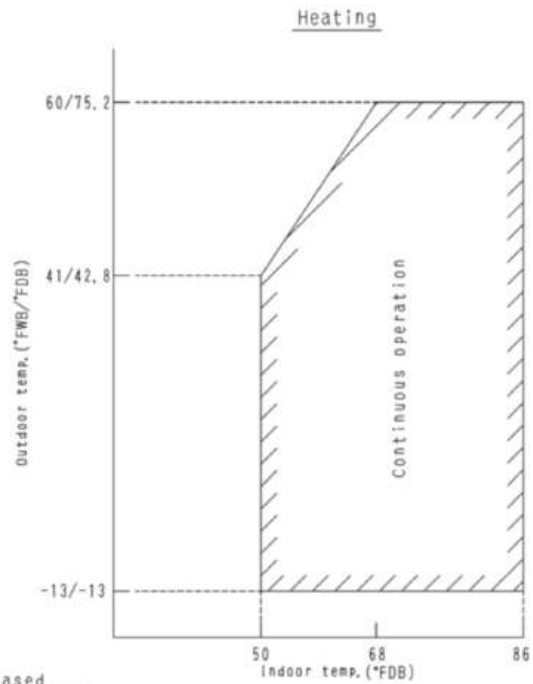
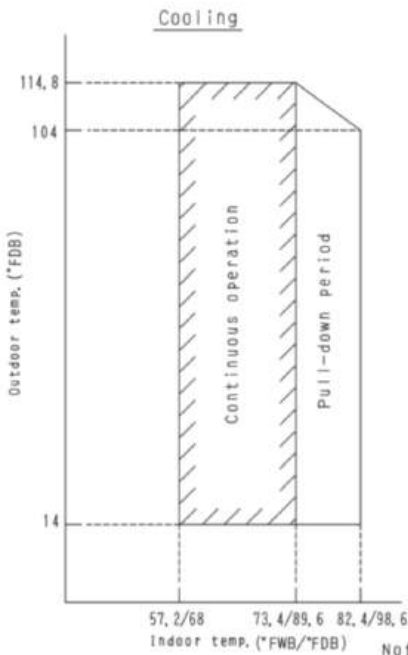

Notes:
 The graphs are based on the following conditions.
 • Equivalent piping length 25ft
 • Level difference 0ft
 • Air flow rate High

3D101428B

5MXM48AVJU9(8)

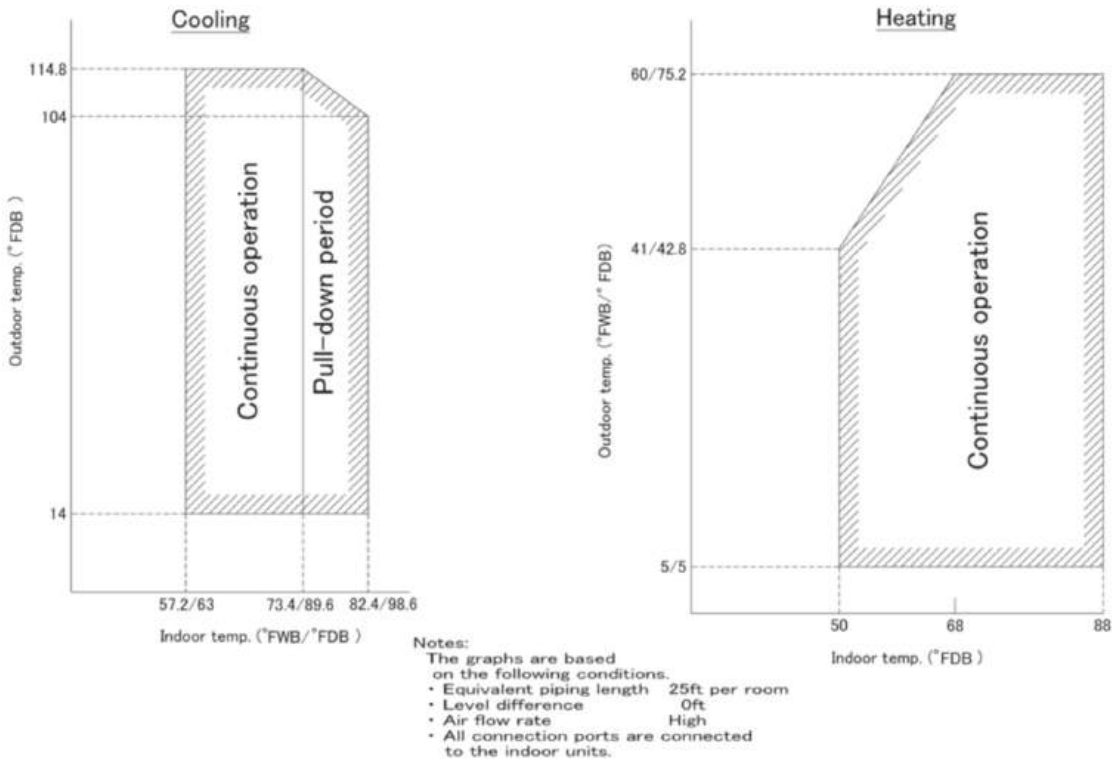

3D158370

3MXT24AVJU9(8), 3MXTH24AVJU9(8), 4MXT36AVJU9(8), 4MXTH36AVJU9(8), 5MXT40AVJU9(8), 5MXTH40AVJU9(8)

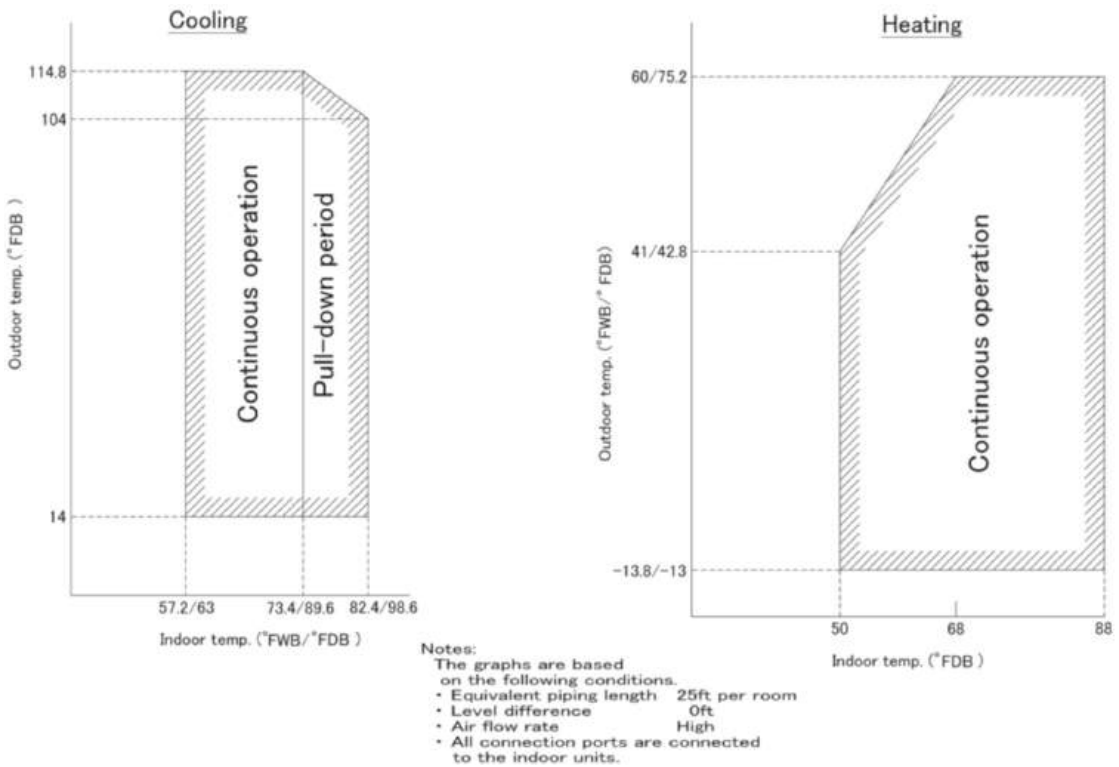

3D158371

4. Refrigerant Leak Detection Sensor Replacement (CMXV models only)

Procedure

1. Take off the blower side access panel and the coil side access panel.
2. Remove the drain pan port gasket from the drain port in front of the sensor bracket, then the sensor bracket assembly from the drain port.
3. Disconnect the refrigerant leak detection sensor wire (X6A) from the PCB (A2P).
4. Remove the plastic push pins and the non-functioning refrigerant leak detection sensor from the bracket.
5. Install new refrigerant leak detection sensor and plastic push pins to the sensor bracket.
6. Reinstall the sensor bracket assembly to the drain port correctly (*). Refer to the indoor unit installation manual for wire routing.
7. The sensor wire drip loop should be formed using a cable tie as shown in the figure below and secured to the bracket.

* The **FRONT 0121A******* printed on the sensor bracket should be facing away from the equipment. Place the gaskets back to the drain ports correctly. **FRONT** printed on the gaskets should be in the front, facing away from the equipment. Reassemble the blower side access panel and the coil side access panel to the unit.

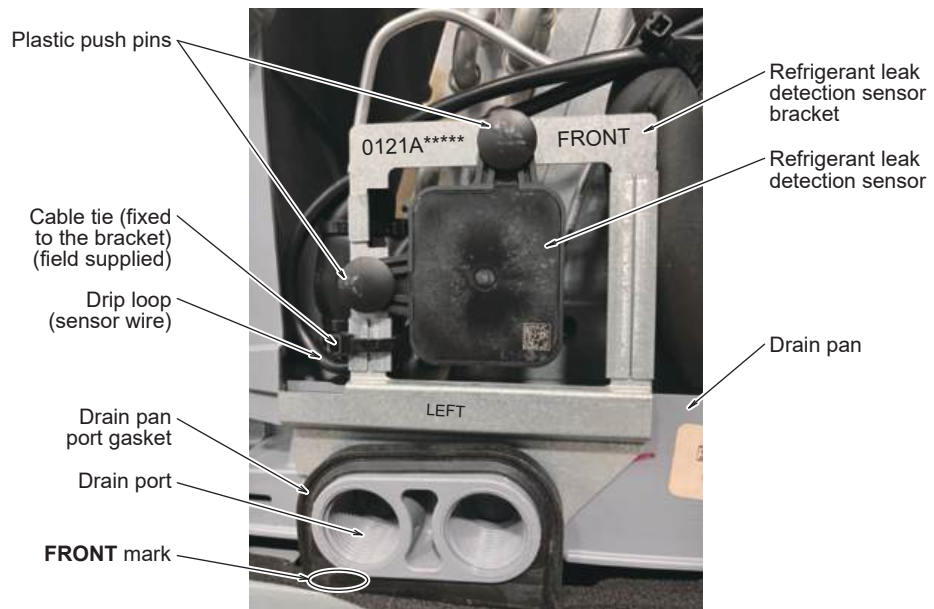

A2L SYSTEM SERVICING

This system is charged with R-32 refrigerant. R-32 is classified as A2L (Mildly flammable) as per ASHRAE 34. This product shall be maintained, serviced, and decommissioned with the prevailing local/federal codes for A2L refrigerant.

5. CMXV Refrigerant Pipe

WARNING: USE THE FLARE NUT FIXED TO THE MAIN UNIT. (THIS IS TO PREVENT THE FLARE NUT FROM CRACKING AS A RESULT OF DETERIORATION OVER TIME.) TO PREVENT GAS LEAKAGE, APPLY REFRIGERATION OIL ONLY TO THE INNER SURFACE OF THE FLARE. (USE REFRIGERATION OIL FOR R-32.) USE A TORQUE WRENCH WHEN TIGHTENING THE FLARE NUTS TO PREVENT DAMAGE TO THE FLARE NUTS AND GAS LEAKAGE. DO NOT HAVE OIL ADHERE TO THE SCREW FIXING PART OF RESIN PARTS. IF OIL ADHERES, IT MAY WEAKEN THE STRENGTH OF SCREWED PART.

Align the centers of both flares and tighten the flare nuts 3 or 4 turns by hand, then tighten them fully with a spanner and a torque wrench.

NOTE: Use the same refrigerant oil type as specified for the outdoor unit compressor when connecting the refrigerant pipes. Refer to the outdoor unit specifications for details.

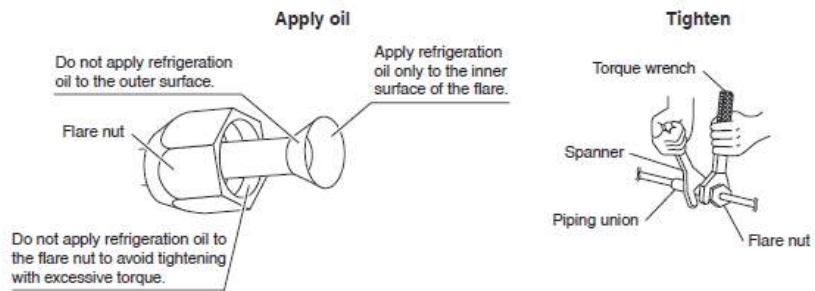

	Piping size	Flare nut tightening torque
Gas side	O.D. 3/8 inch (9.5 mm)	24-1/8 - 29-1/2 lbf • ft (32.7-39.9 N • m)
	O.D. 1/2 inch (12.7 mm)	36-1/2 - 44-1/2 lbf • ft (49.5-60.3 N • m)
	O.D. 5/8 inch (15.9 mm)	45-5/8 - 55-5/8 lbf • ft (61.8-75.4 N • m)
Liquid side	O.D. 1/4 inch (6.4 mm)	10-1/2 - 12-3/4 lbf • ft (14.2-17.2 N • m)

*For CMXV12 If the connection is 1/2" (φ12.7), the installer must install a 3/8" (φ9.5) reducer to reduce the 1/2" (φ12.7) suction line. If the connection is 3/8" (φ9.5), the reducer is not required and should be disregarded.

Warning

- Daikin products are manufactured for export to numerous countries throughout the world. Prior to purchase, please confirm with your local authorized importer, distributor and/or retailer whether this product conforms to the applicable standards, and is suitable for use, in the region where the product will be used. This statement does not purport to exclude, restrict or modify the application of any local legislation.
- Ask a qualified installer or contractor to install this product. Do not try to install the product yourself. Improper installation can result in water or refrigerant leakage, electrical shock, fire or explosion.
- Use only those parts and accessories supplied or specified by Daikin. Ask a qualified installer or contractor to install those parts and accessories. Use of unauthorized parts and accessories or improper installation of parts and accessories can result in water or refrigerant leakage, electrical shock, fire or explosion.
- Read the user's manual carefully before using this product. The user's manual provides important safety instructions and warnings. Be sure to follow these instructions and warnings.

If you have any inquiries, please contact your local importer, distributor and/or retailer.

Cautions on product corrosion

1. Air conditioners should not be installed in areas where corrosive gases, such as acid gas or alkaline gas, are produced.
2. If the outdoor unit is to be installed close to the sea shore, direct exposure to the sea breeze should be avoided. If you need to install the outdoor unit close to the sea shore, contact your local distributor.

© All rights reserved