

# Service and Troubleshooting

## \*SXV9 INVERTER AIR CONDITIONER CONDENSER UNITS WITH R-410A REFRIGERANT

Pride and workmanship go into every product to provide our customers with quality products. It is possible, however, that during its lifetime a product may require service. Products should be serviced only by a qualified service technician who is familiar with the safety procedures required in the repair and who is equipped with the proper tools, parts, testing instruments and the appropriate service manual. **REVIEW ALL SERVICE INFORMATION IN THE APPROPRIATE SERVICE MANUAL BEFORE BEGINNING REPAIRS.**

For service information related to the Bluetooth® Shared Data Loader BTSDL01 referenced in this manual, please refer to the installation instructions for the BTSDL01 at [www.coolcloudhvac.com/loaderuserguide](http://www.coolcloudhvac.com/loaderuserguide)

### TABLE OF CONTENTS

IMPORTANT INFORMATION .....	2
PRODUCT IDENTIFICATION .....	4
SYSTEM OPERATION .....	6
SERVICING .....	13
CHECKING VOLTAGE .....	13
CHECKING WIRING .....	13
CHECKING THERMOSTAT, WIRING .....	13
THERMOSTAT AND WIRING .....	13
THERMOSTAT COMFORTBRIDGE™ SYSTEM .....	13
COMFORTBRIDGE™ SYSTEM WIRING .....	14
CHECKING TRANSFORMER AND CONTROL CIRCUIT .....	14
CHECKING HIGH PRESSURE SWITCH .....	14
CHECKING OUTDOOR HI/LOW PRESSURE SENSOR .....	14
RESISTANCE CHECK (5 TON ONLY) .....	15
CAPACITANCE CHECK (5 TON ONLY) .....	15
CHECKING COMPRESSOR .....	16
COMPRESSOR WINDING INSULATION TEST .....	16
GROUND TEST .....	16
TESTING CRANKCASE HEATER (5 TON ONLY) .....	17
TESTING TEMPERATURE SENSORS AND EEV COIL RESISTANCE .....	17
TESTING EEV COIL RESISTANCE (AMVE AIR HANDLER) .....	17
AMVE HEATER CONTROL (OPTIONAL) .....	17
REFRIGERATION REPAIR PRACTICE .....	18
LEAK TESTING (NITROGEN OR NITROGEN-TRACED) .....	19
SYSTEM EVACUATION .....	19
CHARGING .....	20



### WARNING

ONLY PERSONNEL THAT HAVE BEEN TRAINED TO INSTALL, ADJUST, SERVICE, MAINTENANCE OR REPAIR (HEREINAFTER, "SERVICE") THE EQUIPMENT SPECIFIED IN THIS MANUAL SHOULD SERVICE THE EQUIPMENT.

THIS EQUIPMENT IS NOT INTENDED FOR USE BY PERSONS (INCLUDING CHILDREN) WITH REDUCED PHYSICAL, SENSORY OR MENTAL CAPABILITIES, OR LACK OF EXPERIENCE AND KNOWLEDGE, UNLESS THEY HAVE BEEN GIVEN SUPERVISION OR INSTRUCTION CONCERNING USE OF THE APPLIANCE BY A PERSON RESPONSIBLE FOR THEIR SAFETY.

CHILDREN SHOULD BE SUPERVISED TO ENSURE THAT THEY DO NOT PLAY WITH THE EQUIPMENT.

THE MANUFACTURER WILL NOT BE RESPONSIBLE FOR ANY INJURY OR PROPERTY DAMAGE ARISING FROM IMPROPER SUPERVISION, SERVICE OR SERVICE PROCEDURES. IF YOU SERVICE THIS UNIT, YOU ASSUME RESPONSIBILITY FOR ANY INJURY OR PROPERTY DAMAGE WHICH MAY RESULT. IN ADDITION, IN JURISDICTIONS THAT REQUIRE ONE OR MORE LICENSES TO SERVICE THE EQUIPMENT SPECIFIED IN THIS MANUAL, ONLY LICENSED PERSONNEL SHOULD SERVICE THE EQUIPMENT. IMPROPER SUPERVISION, INSTALLATION, ADJUSTMENT, SERVICING, MAINTENANCE OR REPAIR OF THE EQUIPMENT SPECIFIED IN THIS MANUAL, OR ATTEMPTING TO INSTALL, ADJUST, SERVICE OR REPAIR THE EQUIPMENT SPECIFIED IN THIS MANUAL WITHOUT PROPER SUPERVISION OR TRAINING MAY RESULT IN PRODUCT DAMAGE, PROPERTY DAMAGE, PERSONAL INJURY OR DEATH.



### WARNING

DO NOT BYPASS SAFETY DEVICES.

RS6115001r13  
March 2023

© 2019-2023 Daikin Comfort Technologies Manufacturing, L.P.

**Amana** is a registered trademark of Maytag Corporation or its related companies and is used under license. All rights reserved.

# IMPORTANT INFORMATION



CHECKING COMPRESSOR EFFICIENCY .....	21
THERMOSTATIC EXPANSION VALVE .....	21
OVERFEEDING .....	21
UNDERFEEDING .....	21
SUPERHEAT .....	21
CHECKING SUBCOOLING .....	22
CHECKING THERMOSTATIC EXPANSION VALVE OPERATION.....	23
NON-CONDENSABLES.....	23
COMPRESSOR BURNOUT .....	24
REFRIGERANT PIPING .....	24
DUCT STATIC PRESSURES AND/OR STATIC PRESSURE DROP ACROSS COILS .....	28
AIR HANDLER EXTERNAL STATIC .....	28
COIL STATIC PRESSURE DROP.....	28
INDOOR UNIT SETTING THE MODE DISPLAY .....	42
OUTDOOR UNIT SETTING THE MODE DISPLAY ..	54
7-SEGMENT DISPLAY.....	60
TROUBLESHOOTING .....	63
WIRING DIAGRAMS .....	108
ACCESSORIES.....	113

## IMPORTANT NOTICES

### RECOGNIZE SAFETY SYMBOLS, WORDS AND LABELS

Pride and workmanship go into every product to provide our customers with quality products. It is possible, however, that during its lifetime a product may require service. Products should be serviced only by a qualified service technician who is familiar with the safety procedures required in the repair and who is equipped with the proper tools, parts, testing instruments and the appropriate service manual.

**REVIEW ALL SERVICE INFORMATION IN THE APPROPRIATE SERVICE MANUAL BEFORE BEGINNING REPAIRS.**

 <b>WARNING</b>	
<p><b>HIGH VOLTAGE</b> DISCONNECT ALL POWER BEFORE SERVICING OR INSTALLING THIS UNIT. MULTIPLE POWER SOURCES MAY BE PRESENT. FAILURE TO DO SO MAY CAUSE PROPERTY DAMAGE, PERSONAL INJURY OR DEATH.</p>	

 <b>WARNING</b>
<p>DO NOT CONNECT TO OR USE ANY DEVICE THAT IS NOT DESIGN CERTIFIED BY THE MANUFACTURER FOR USE WITH THIS UNIT. SERIOUS PROPERTY DAMAGE, PERSONAL INJURY, REDUCED UNIT PERFORMANCE AND/OR HAZARDOUS CONDITIONS MAY RESULT FROM THE USE OF SUCH NON-APPROVED DEVICES.</p>

 <b>WARNING</b>
<p>TO PREVENT THE RISK OF PROPERTY DAMAGE, PERSONAL INJURY, OR DEATH, DO NOT STORE COMBUSTIBLE MATERIALS OR USE GASOLINE OR OTHER FLAMMABLE LIQUIDS OR VAPORS IN THE VICINITY OF THIS APPLIANCE.</p>

**NOTICE:** Inverter air conditioner models can only be matched with an AMVE\*\* air handler or TXV-V\*\* expansion valve kit. Damage resulting from operation with any other combination is not covered by our warranties.

### SAFE REFRIGERANT HANDLING

While these items will not cover every conceivable situation, they should serve as a useful guide.

 <b>WARNING</b>
<p>REFRIGERANTS ARE HEAVIER THAN AIR. THEY CAN “PUSH OUT” THE OXYGEN IN YOUR LUNGS OR IN ANY ENCLOSED SPACE. TO AVOID POSSIBLE DIFFICULTY IN BREATHING OR DEATH:</p> <ul style="list-style-type: none"> <li>• NEVER PURGE REFRIGERANT INTO AN ENCLOSED ROOM OR SPACE. BY LAW, ALL REFRIGERANTS MUST BE RECLAIMED.</li> <li>• IF AN INDOOR LEAK IS SUSPECTED, THOROUGHLY VENTILATE THE AREA BEFORE BEGINNING WORK.</li> <li>• LIQUID REFRIGERANT CAN BE VERY COLD. TO AVOID POSSIBLE FROST BITE OR BLINDNESS, AVOID CONTACT AND WEAR GLOVES AND GOGGLES. IF LIQUID REFRIGERANT DOES CONTACT YOUR SKIN OR EYES, SEEK MEDICAL HELP IMMEDIATELY.</li> <li>• IF REFRIGERANT GAS LEAKS DURING INSTALLATION, VENTILATE THE AREA IMMEDIATELY. REFRIGERANT GAS WILL RESULT IN PRODUCING TOXIC GAS IF IT COMES INTO CONTACT WITH FIRE. EXPOSURE TO THIS GAS WILL RESULT IN SEVERE INJURY OR DEATH.</li> <li>• AFTER COMPLETING THE INSTALLATION WORK, CHECK THAT THE REFRIGERANT GAS DOES NOT LEAK THROUGHOUT THE SYSTEM.</li> <li>• DO NOT INSTALL UNIT IN AN AREA WHERE FLAMMABLE MATERIALS ARE PRESENT DUE TO RISK OF EXPLOSIONS THAT WILL RESULT IN SERIOUS INJURY OR DEATH.</li> <li>• WHEN INSTALLING THE UNIT IN A SMALL ROOM, TAKE MEASURES TO KEEP THE REFRIGERANT CONCENTRATION FROM EXCEEDING ALLOWABLE SAFETY LIMITS. EXCESSIVE REFRIGERANT LEAKS, IN THE EVENT OF AN ACCIDENT IN A CLOSED AMBIENT SPACE, COULD RESULT IN OXYGEN DEFICIENCY.</li> <li>• ALWAYS FOLLOW EPA REGULATIONS. NEVER BURN REFRIGERANT, AS POISONOUS GAS WILL BE PRODUCED.</li> </ul>

 <b>WARNING</b>
<p>THE UNITED STATES ENVIRONMENTAL PROTECTION AGENCY (“EPA”) HAS ISSUED VARIOUS REGULATIONS REGARDING THE INTRODUCTION AND DISPOSAL OF REFRIGERANTS INTRODUCED INTO THIS UNIT. FAILURE TO FOLLOW THESE REGULATIONS MAY HARM THE ENVIRONMENT AND CAN LEAD TO THE IMPOSITION OF SUBSTANTIAL FINES. THESE REGULATIONS MAY VARY BY JURISDICTION. SHOULD QUESTIONS ARISE, CONTACT YOUR LOCAL EPA OFFICE.</p>

OUTSIDE THE U.S., call 1-713-861-2500.

(Not a technical assistance line for dealers.) Your telephone company will bill you for the call.

# IMPORTANT INFORMATION



## WARNING

### TO AVOID POSSIBLE EXPLOSION:

- NEVER APPLY FLAME OR STEAM TO A REFRIGERANT CYLINDER. IF YOU MUST HEAT A CYLINDER FOR FASTER CHARGING, PARTIALLY IMMERSE IT IN WARM WATER.
- NEVER FILL A CYLINDER MORE THAN 80% FULL OF LIQUID REFRIGERANT.
- NEVER ADD ANYTHING OTHER THAN R-22 TO AN R-22 CYLINDER OR R-410A TO AN R-410A CYLINDER. THE SERVICE EQUIPMENT USED MUST BE LISTED OR CERTIFIED FOR THE TYPE OF REFRIGERANT USED.
- STORE CYLINDERS IN A COOL, DRY PLACE. NEVER USE A CYLINDER AS A PLATFORM OR A ROLLER.



## WARNING

- TO AVOID POSSIBLE EXPLOSION:
- USE ONLY RETURNABLE (NOT DISPOSABLE) SERVICE CYLINDERS WHEN REMOVING REFRIGERANT FROM A SYSTEM.
- ENSURE THE CYLINDER IS FREE OF DAMAGE WHICH COULD LEAD TO A LEAK OR EXPLOSION.
- ENSURE THE HYDROSTATIC TEST DATE DOES NOT EXCEED 5 YEARS.
- ENSURE THE PRESSURE RATING MEETS OR EXCEEDS 400 LBS. WHEN IN DOUBT, DO NOT USE CYLINDER.



## WARNING

TO AVOID POSSIBLE INJURY, EXPLOSION OR DEATH, PRACTICE SAFE HANDLING OF REFRIGERANTS.



## CAUTION

THE COMPRESSOR PVE OIL FOR R-410A UNITS IS EXTREMELY SUSCEPTIBLE TO MOISTURE ABSORPTION AND COULD CAUSE COMPRESSOR FAILURE. DO NOT LEAVE SYSTEM OPEN TO ATMOSPHERE ANY LONGER THAN NECESSARY FOR INSTALLATION.

**NOTICE:** The entire system (combination of indoor and outdoor sections) must be manufacturer approved and Air-Conditioning, Heating and Refrigerant Institute (AHRI) listed.

**NOTE:** Installation of unmatched systems is not permitted. Damage or repairs due to installation of unmatched systems is not covered under the warranty.

**NOTICE:** Approved systems are combination of ComfortBridge compatible indoor unit and single-stage thermostat (with dehumidification function).



## WARNING

SYSTEM CONTAMINANTS, IMPROPER SERVICE PROCEDURE AND/OR PHYSICAL ABUSE AFFECTING HERMETIC COMPRESSOR ELECTRICAL TERMINALS MAY CAUSE DANGEROUS SYSTEM VENTING.

**NOTICE:** When the outdoor unit is connected to main power, the inverter board has a small current flowing into it to be prepared for operation when needed. Due to this, the Control Board components have to be cooled even when the unit is not running. For this cooling operation, the condenser fan may come on at any time, including in the winter months. Any obstruction to the outdoor fan should be avoided at all times when the unit is powered to prevent damage.

The successful development of hermetically sealed refrigeration compressors has completely sealed the compressor's moving parts and electric motor inside a common housing, minimizing refrigerant leaks and the hazards sometimes associated with moving belts, pulleys or couplings.

Fundamental to the design of hermetic compressors is a method whereby electrical current is transmitted to the compressor motor through terminal conductors which pass through the compressor housing wall. These terminals are sealed in a dielectric material which insulates them from the housing and maintains the pressure tight integrity of the hermetic compressor. The terminals and their dielectric embedment are strongly constructed, but are vulnerable to careless compressor installation or maintenance procedures and equally vulnerable to internal electrical short circuits caused by excessive system contaminants.

In either of these instances, an electrical short between the terminal and the compressor housing may result in the loss of integrity between the terminal and its dielectric embedment. This loss may cause the terminals to be expelled, thereby venting the vaporous and liquid contents of the compressor housing and system.

A venting compressor terminal normally presents no danger to anyone, providing the terminal protective cover is properly in place.

If, however, the terminal protective cover is not properly in place, a venting terminal may discharge a combination of

- (a) hot lubricating oil and refrigerant
- (b) flammable mixture (if system is contaminated with air)

in a stream of spray which may be dangerous to anyone in the vicinity. Death or serious bodily injury could occur.

Under no circumstances is a hermetic compressor to be electrically energized and/or operated without having the terminal protective cover properly in place.

See Service Section for proper servicing.

# PRODUCT IDENTIFICATION

# NOMENCLATURES

	A	S	X	V	9	0	36	1	0	A	A	
	1	2	3	4	5	6	7,8	9	10	11	12	
<b>Brand</b> A: Amana® Brand												<b>Minor Revision</b> A: Initial Release B: 1st Revision
<b>Product Category</b> S: Split System R-410A												<b>Major Revision</b> A: Initial Release B: 1st Revision
<b>Unit Type</b> X: Condenser Z: Heat Pump												<b>Variation</b>
<b>Feature</b> N: Value      C: Premium H: Enhanced    V: Ultimate												<b>Electrical</b> 1 - 208/230 V, 1 Phase, 60 Hz
<b>Efficiency (SEER2)</b> 13.4 - 13.7 = 3    16.6 - 17.5 = 7 13.8 - 14.5 = 4    17.6 - 18.5 = 8 14.6 - 15.5 = 5    18.6 - 19.5 = 9 15.6 - 16.5 = 6    19.6 + = 0												<b>Nominal Capacity</b> 24 - 2.0 Tons    48 - 4.0 Tons 36 - 3.0 Tons    60 - 5.0 Tons
												<b>Sales Region</b> N: North S: Southeast & North O: All Region

	G	S	X	V	9	0	36	1	0	A	A	
	1	2	3	4	5	6	7,8	9	10	11	12	
<b>Brand</b> G: Goodman® Brand												<b>Minor Revision</b> A: Initial Release B: 1st Revision
<b>Product Category</b> S: Split System R-410A												<b>Major Revision</b> A: Initial Release B: 1st Revision
<b>Unit Type</b> X: Condenser Z: Heat Pump												<b>Variation</b>
<b>Feature</b> N: Value      C: Premium H: Enhanced    V: Ultimate												<b>Electrical</b> 1 - 208/230 V, 1 Phase, 60 Hz
<b>Efficiency (SEER2)</b> 13.4 - 13.7 = 3    16.6 - 17.5 = 7 13.8 - 14.5 = 4    17.6 - 18.5 = 8 14.6 - 15.5 = 5    18.6 - 19.5 = 9 15.6 - 16.5 = 6    19.6 + = 0												<b>Nominal Capacity</b> 24 - 2.0 Tons    48 - 4.0 Tons 36 - 3.0 Tons    60 - 5.0 Tons
												<b>Sales Region</b> N: North S: Southeast & North O: All Region

# PRODUCT IDENTIFICATION

# NOMENCLATURES

	A	M	V	E	36	B	P	1	4	00 **	A	A *	
	1	2	3	4	5,6	7	8	9	10	11,12	13	14	
<b>Brand</b> A - Corporate Air Handler													<b>Minor Rev</b> A
<b>Unit Application</b> C - Ceiling Mounted M - Multi-Positional W - Wall Mounted													<b>Major Rev</b> A
<b>Motor</b> S - MS-ECM V - VS-ECM Communicating													<b>Electric Heat kW</b>
<b>Expansion Device</b> E - Electronic Expansion Valve F - Flowrator T - Thermal Expansion Valve													<b>Refrigerant</b> 4 - R410A
<b>Nominal Capacity Range</b> 12 - 1 Tons 18 - 1½ Tons 24 - 2 Tons 30 - 2½ Tons													<b>Electrical</b> 1 208/230 V, 1 Phase 60Hz
													<b>Cabinet</b> N - Uncased P - Painted U - Unpainted
													<b>Cabinet Width</b> AC* Series M - 43.25" L - 49.25" AM* Series B - 17.5" C - 21.0" D - 24.5" AW* Series S - 20.2" L - 24.0"

# SYSTEM OPERATION

This section gives a basic description of Air Conditioner condenser unit operation, its various components and their basic operation. Ensure your system is properly sized for heat gain and loss according to methods of the Air Conditioning Contractors Association (ACCA) or equivalent.

## CONDENSING UNIT

The ambient air is pulled through the Air Conditioner condenser coil by a direct drive propeller fan. This air is then discharged out of the top of the cabinet. These units are designed for free air discharge, so no additional resistance, like duct work, shall be attached.

The gas and liquid line connections on present models are of the sweat type for field piping with refrigerant type copper. Front seating valves are factory installed to accept the field run copper. The total refrigerant charge for a normal installation is factory installed in the Air Conditioner condenser unit.

\*SXV9 models are available in 2 through 5 ton sizes and use R-410A refrigerant. They are designed for 208/230 volt single phase applications.

\*SXV9 R-410A model units use a Daikin rotary compressor. These models are ComfortBridge™ and ComfortNet™ ready.

There are a number of design characteristics which are different from the traditional compressors.

\*SXV9 models use “FVC50K” which is NOT compatible with mineral oil based lubricants like 3GS. “FVC50K” oil (required by the manufacturer) must be used if additional oil is required.

## COOLING

The refrigerant used in the system is R-410A. It is a clear, colorless, non-toxic and non-irritating liquid. R-410A is a 50:50 blend of R-32 and R-125. The boiling point at atmospheric pressure is -62.9°F.

A few of the important principles that make the refrigeration cycle possible are: heat always flows from a warmer to a cooler body. Under lower pressure, a refrigerant will absorb heat and vaporize at a low temperature. The vapors may be drawn off and condensed at a higher pressure and temperature to be used again.

The indoor evaporator coil functions to cool and dehumidify the air conditioned spaces through the evaporative process taking place within the coil tubes.

**NOTE:** The pressures and temperatures shown in the refrigerant cycle illustrations on the following pages are

for demonstration purposes only. Actual temperatures and pressures are to be obtained from the “Expanded Performance Chart”.

Liquid refrigerant at condensing pressure and temperatures leaves the outdoor condensing coil through the drier and is metered into the indoor coil through the metering device. As the cool, low pressure, saturated refrigerant enters the tubes of the indoor coil, a portion of the liquid immediately vaporizes. It continues to soak up heat and vaporizes as it proceeds through the coil, cooling the indoor coil down to about 48°F.

Heat is continually being transferred to the cool fins and tubes of the indoor evaporator coil by the warm system air. This warming process causes the refrigerant to boil. The heat removed from the air is carried off by the vapor.

As the vapor passes through the last tubes of the coil, it becomes superheated. That is, it absorbs more heat than is necessary to vaporize it. This is assurance that only dry gas will reach the compressor. Liquid reaching the compressor can weaken or break compressor valves.

The compressor increases the pressure of the gas, thus adding more heat, and discharges hot, high pressure superheated gas into the outdoor condenser coil.

In the condenser coil, the hot refrigerant gas, being warmer than the outdoor air, first loses its superheat by heat transferred from the gas through the tubes and fins of the coil. The refrigerant now becomes saturated, part liquid, part vapor and then continues to give up heat until it condenses to a liquid alone. Once the vapor is fully liquefied, it continues to give up heat which subcools the liquid, and it is ready to repeat the cycle.

The inverter system can stop the compressor or outdoor fan to protect the unit. The inverter system can run higher compressor speed than required from thermostat to recover compressor oil that flows.

## SYSTEM STARTUP TEST

**NOTICE:** On initial power start-up, the outdoor unit will display code E11, signaling that initial SYSTEM test must be run. Follow the instructions BELOW to initiate and complete the testing.

A system verification test is now required to check the equipment settings and functionality.

Inverter units are tested by any of the following methods:

- Setting the “SU” menu (System verification test) to ON through the indoor unit control board push buttons.
- Setting the System verification test menu of mode display screen-4 to ON through the outdoor unit control board push buttons.
- Through the CoolCloud HVAC phone application.

# SYSTEM OPERATION

Once selected, it checks the equipment for approximately 5 - 15 minutes. System test may exceed 15 minutes if there is an error. Refer to the Troubleshooting section, if error code appears.

Before starting the SYSTEM TEST, turn off the electric heater and gas furnace.

**NOTE:** If the unit is attempting to run SYSTEM TEST in under 20°F ambient temperature, the unit may not be able to complete the test due to low suction pressure. In such a case, re-run the SYSTEM TEST when the ambient temperature exceeds 20°F.

## COOLCLOUD™ HVAC PHONE APPLICATION

The CoolCloud HVAC phone application designed to improve the contractor's setup /diagnostic experience. This application can only use with the ComfortBridge compatible indoor unit and can download through CoolCloud website at <https://www.coolcloudhvac.com>, Google Play or the Apple App Store.

Users can see specific model information, review active diagnostic error codes, observe system status during operation, make system menu adjustments, add site visit notes and run system testing of all operational modes (heat / cool / fan) directly from the phone.

The phone application is also capable of directly updating the ComfortBridge compatible indoor unit software anytime updates are available.

The application will automatically notify the user if updates are available.

**NOTE:** The software update may take up to 20 minutes to complete.

## CHARGE MODE

CHARGE mode allows for charging of the system. System operates for a duration of approximately one hour while the equipment runs at full capacity.

After one hour, the CHARGE MODE ends and the system resumes normal operation.

Before starting the CHARGE MODE, turn off the Cool or Heat mode and electric heater or gas furnace.

- a. Inverter units are charged by any of the following methods:
  - Setting the "CR9" menu (Charge Mode) to ON through the indoor unit control board push buttons.

- Setting the Charge mode menu of mode display screen-4 to ON through the outdoor unit control board push buttons.
  - Through the CoolCloud HVAC phone application.
- b. The System will remain in charge mode (high speed) for 60 minutes before timing out.
  - c. When charge mode once complete, the installer must manually shut off.

**NOTE:** Charge mode is for validating sub cooling. To ensure a proper initial charge, the amount of refrigerant added must be weighed in after measuring the line set and calculating additional charge.

**NOTICE:** When put into CHARGE MODE the 7-segment display will begin blinking "cha" lights. Once the system is stable the "cha" lights will stop blinking and stay solid (will take around 30 minutes). Using service equipment, add or recover refrigerant according to the calculation in Step 1.

**Do not adjust refrigerant level if the "cha" lights are not solid.**

## BOOST MODE

BOOST MODE can be enabled or disabled through the control board push buttons or through the CoolCloud app.

BOOST MODE allows the system to operate at increased compressor speed to satisfy unusual high loads. BOOST MODE is initiated by an outdoor temperature sensor located in the outdoor unit.

Please note that outdoor equipment operational sound levels may increase while the equipment is running in BOOST MODE. Disabling BOOST MODE will provide the quietest and most efficient operation.

BOOST MODE is ON by default and is activated when the outdoor temperature reaches 105°F. BOOST MODE can be disabled and enabled and the activation temperature adjusted in the Settings menu of the CoolCloud app or through the indoor / outdoor push button menus.

## DEHUMIDIFICATION

The thermostat reads the indoor humidity level and allows the user to set a dehumidification target based on these settings. The thermostat controls the humidity level of the conditioned space using the cooling system. Dehumidification is engaged whenever a cooling demand is present and structural humidity levels are above the target level. When this condition exists, the circulating fan output is reduced, increasing system run time, over cooling the evaporator coil and ultimately removing more humidity from the structure than if only in cooling mode. The thermostat also allows for an additional overcooling limit setting from 0°F to 3°F

# SYSTEM OPERATION

setup. This allows the cooling system to further reduce humidity by lowering the temperature up to 3°F below the cooling setpoint in an attempt to better achieve desired humidity levels.

## DEHUMIDIFICATION TIPS\* (ComfortNet Systems Only)

For effective dehumidification operation:

- Ensure “Dehumidification” is not set to “OFF”
- Verify the cooling airflow profile (cool profiles) is set to “Profile D”.
  - See the Cool Set-up section of the Installation Manual for complete airflow profile details.
  - By default, “dehumidification selection” is standard and the cooling airflow profile is set to “Profile D”.
- For additional dehumidification control, airflow settings are field adjustable and can be fine-tuned to a value that is comfortable for the application from a range of Cool Airflow Trim.
- In addition, the system can have Enhanced Dehumidification operation in setting “A”, “B”, or “C” of dehumidification based on dehumidification demand.
- See the Dehumidification Select section for more detail.

## COMFORTBRIDGE™ SYSTEM OVERVIEW

The ComfortBridge based inverter heating and air conditioning system uses an indoor unit and outdoor unit digitally communicating with one another via a two-way communications path.

The 24 VAC single-stage thermostat sends commands to the indoor and outdoor units.

The indoor and outdoor units interacting with one another directly while taking simple analog commands from the thermostat are the core of unlocking the benefits and features of the ComfortBridge control system.

**NOTE:** It is strongly recommend the use of thermostat with humidity sensor and dehumidification terminal. Without these functions, dehumidification operation does not work.

## COMFORTBRIDGE SYSTEM ADVANCED FEATURES

The ComfortBridge system permits access to additional system information, advanced set-up features, and advanced diagnostic/troubleshooting features via the control board push buttons or the CoolCloud mobile app.

## FAULT CODE HISTORY

The Air Conditioner’s diagnostics menu provides access to the most recent faults. The six most recent faults can be accessed through the control board seven segment displays or the CoolCloud mobile app. Any consecutively repeated fault is stored a maximum of three times.

**EXAMPLE:** A leak in the system, low refrigerant charge or an incompletely open stop valve can cause the unit to flash error code E15. This error code suggests that the unit is experiencing operation at low pressure. The control will only store this fault the first three consecutive times the fault occurs.

**NOTE:** The fault list can be cleared after performing maintenance or servicing the system to assist in the troubleshooting process.

## DEVICE STATUS

This menu displays information about the systems current status. This menu can be utilized to confirm correct functionality of the equipment and for troubleshooting purposes.

The following items will be displayed:

- Heat Capacity Request Percentage
- Cool Capacity Request Percentage
- Heat Capacity Request During Defrost Percentage
- Dehumidification Request Percentage
- Reversing Valve Status
- Reported Airflow by Indoor Unit
- Boost Mode
- Previous Defrost Run Time

## SENSOR DATA

The following sensor items will be displayed:

- Outdoor Temperature
- Coil Temperature
- Liquid Line Temperature
- Discharge Temperature
- Defrost Sensor
- Suction Pressure

## PUMP DOWN

This function can be enabled this menu.

## SET 7-SEGMENT MODE DISPLAY TO PUMP DOWN

Please follow the following sequence to enter PUMP DOWN to accumulate the refrigerant to outdoor unit by 7 Segment Mode. Do not operate COOL ON or HEAT ON mode to enter PUMP DOWN.



# SYSTEM OPERATION

Before starting the PUMP DOWN operation, change indoor fan trim, delay and profile back to default and stop electric heater and gas furnace. Remove if no trim feature. In this operation, the gas and liquid service valve should be opened.

1. Set 7-segment display to SCREEN 4 (SETTING MODE 2) Setting No. 8 and change the display from “-01” to “-00” System will then automatically start PUMP DOWN operation. For information on how to set 7-segment display, see the section SETTING THE MODE DISPLAY in this manual.
2. Approximately one minute later, the compressor should start operating. Check the amperage at the compressor wiring to see the compressor operation status. Unit display error code E11 (System verification Test) once the PUMP DOWN operations starts.
3. Close liquid service valve approximately two minutes after compressor has come on.
4. Compressor will come to a stop automatically. Close the suction service valve immediately after the compressor stops. After completion of PUMP DOWN, unit shows error code “E11”.

**NOTE:** Refrigerant cannot be collected to the outdoor unit completely if the system is overcharged or if there is a delay in closing the liquid service valve and suction service valve. Evacuate the left over refrigerant from the system using a recovery machine.

## SYSTEM VERIFICATION TEST

The mandatory system verification test is enabled from this menu, which enables a functional check of the equipment, in addition to ensuring proper stop valve position.

## COOL SET-UP

The system allows for the adjustment of several cooling performance variables. Cool Airflow Trim (\*1), Cool Airflow Profiles, Cool Fan ON Delay, Cool Fan OFF Delay and Dehumidification Select (some enable option or off ) can be adjusted in this menu. You can also reset this entire menu to factory default settings.

See the following images showing the four cooling airflow profiles.

## COOLING AIRFLOW PROFILE

- Profile A provides only an OFF delay of one (1) minute at 100% of the cooling demand airflow.

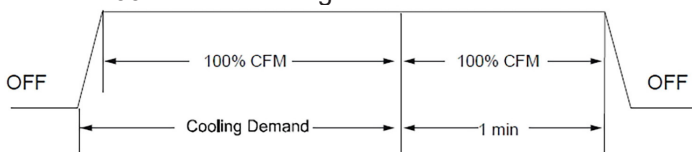

- Profile B ramps up to full cooling demand airflow by first stepping up to 50% of the full demand for 30 seconds. The motor then ramps to 100% of the required airflow. A one (1) minute OFF delay at 100% of the cooling airflow.

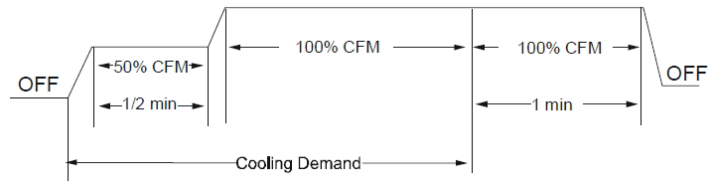

- Profile C ramps up to 82% of the full cooling demand airflow and operates there for approximately 7 1/2 minutes. The motor then steps up to the full demand airflow. Profile C also has a one (1) minute 100% OFF delay.

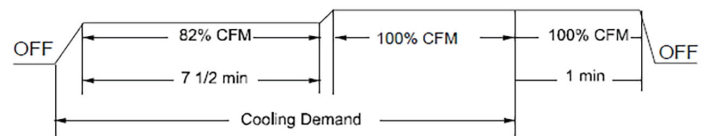

- Profile D (default) ramps up to 50% of the demand for 1/2 minute, then ramps to 82% of the full cooling demand airflow and operates there for approximately 7 1/2 minutes. The motor then steps up to the full demand airflow. Profile D has a 1/2 minute at 50% airflow OFF delay.

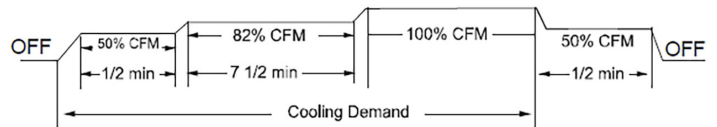

## HEAT SET-UP

This menu allows for the adjustment of several heating performance variables. Heat Airflow trim (\*1), Heat Fan ON Delay, Heat Fan OFF Delay and timed Defrost interval can be adjusted in this menu. Time interval of 30, 60, 90 and 120 minutes between two defrost cycles can be set to suit the weather conditions and performance of the unit.

## SET THERMOSTAT TO ADJUST INDOOR AIR CFM TRIM\*1

User can change the airflow trim at high, intermediate and low for cooling.

Select:

Cool/Heat Airflow Trim (High): high speed cooling/heating  
 Cool/Heat Airflow Trim (Int): intermediate speed cooling/heating  
 Cool/Heat Airflow Trim (Low): low speed cooling/heating  
 Under each trim setting, the airflow can be increased or decreased by a certain percentage.

# SYSTEM OPERATION

\*1

- 1) At Cool and Heat Hi speed trim, \*SXV906010\*\* with \*\*VC960804C, \*\*VM970804C and \*MVC800804C combination trim more than 5% settings are invalid. Trimmed up CFM makes miss matching error.
- 2) At Cool Hi speed trim, Other than the above, depending on the connected indoor unit, there are restrictions on the positive side Trim setting.  
If you want to change the Cool Airflow Trim to positive side, be sure to confirm the Airflow Trim restrictions in the latest indoor unit installation manual. The latest manual can be obtained from the website “PartnerLink(InfoFinderPlus/ Literature)”.  
[PartnerLink URL]  
<https://partnerlinkmarketing.goodmanmfg.com/goodman/info-finder-plus>
- 3) At Cool Intermediate and Low speed trim, The Inverter system uses lower compressor speed and lower indoor unit CFM to optimize system performance. To obtain 100% CFM for home circulation, use full Trim setting instead of Int/Low speed. This is recommended for applications with unusually cold return temperatures such as basements.

## DEHUMIDIFICATION SELECT\*

When Dehumidification mode exists, the circulating fan output is reduced, increasing system run time, over cooling the evaporator coil and ultimately removing more humidity from the structure than if only in cooling mode.

The system can have Dehumidification operation in setting “Standard”, “A”, “B” or “C” of “dehumidify with cooling” menu based on dehumidification demand.

Setting “Standard” allows for the widest compressor operation range with lower CFM than Cooling mode.

In the Enhanced Dehumidification (setting A, B and C) the indoor airflow is lower than Standard Dehumidification (Standard).

Setting “A” allows for the same compressor operation range in Dehumidification operation with lower CFM than standard dehumidification (Standard).

Setting “B” limits compressor operation range and keeps high dehumidification capacity.

In setting “C” the system runs fixed at 100% compressor and airflow. See Figure 1.

**NOTE:** In high humidity environments, sweating on supply ducts, cased coils or air handler cabinets can become an issue in Enhanced Dehumidification operation. It is strongly recommended covering then with 2” fiberglass insulation for these installations.

For details, see the Installation Manual or Service Manual that matches the Major and Minor revision of model name.

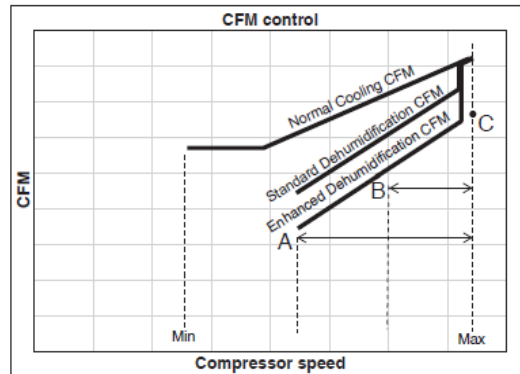

Figure 1

## MAX COMPRESSOR RPS FOR COOLING/HEATING (SELECTED RPS/ RPS range)

Max compressor speed at which the outdoor unit will operate can be changed through the control board seven segment displays or the CoolCloud mobile app.

Max compressor speed can be changed to get the required capacity or efficiency.

Once the maximum speed is set, the system operates between the set maximum speed and default low speed.

When determining the appropriate speed compressor speed for cooling and heating, in the “RPS Range For Cooling/ Heating” menu select the range that contains the desired value. (Then, after pressing the Apply Changes button, leave the Device setting menu and enter this menu again. Otherwise, the changed settings will not be reflected.) Next, in the “Selected RPS for Cooling/Heating” menu, select the desired RPS within the displayed range.

# SYSTEM OPERATION

## COOLING CYCLE

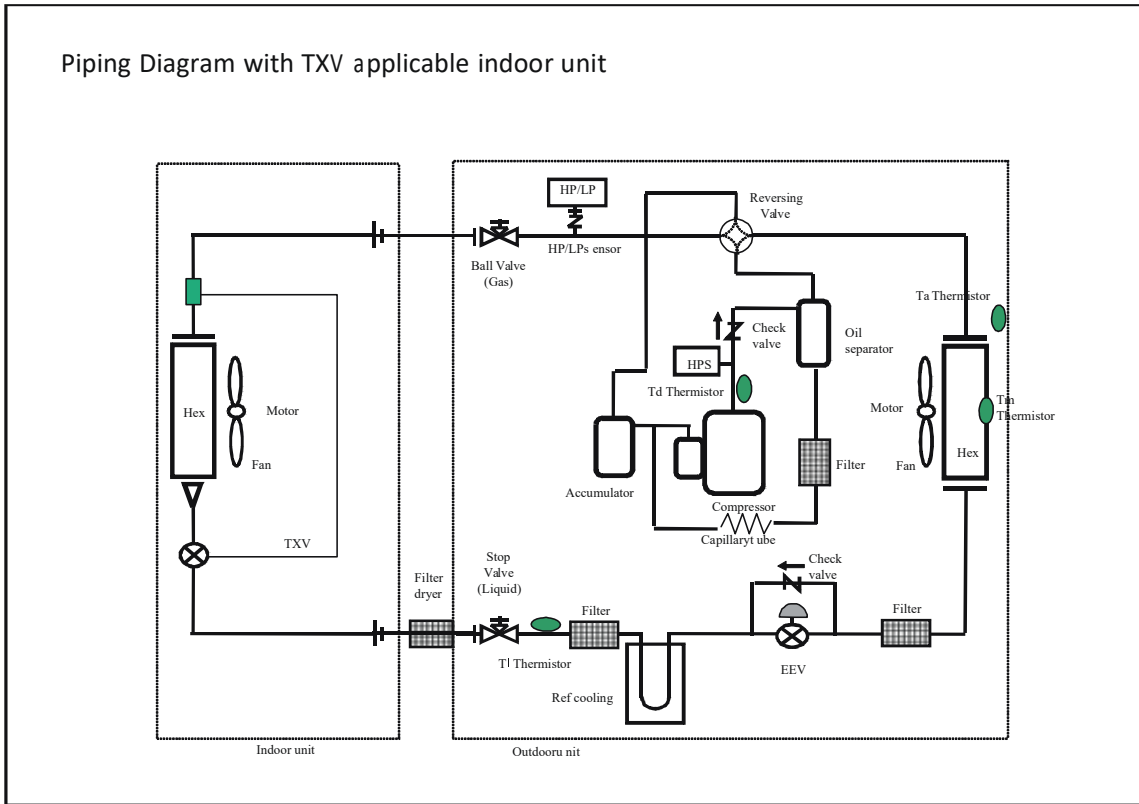

**LEGEND:**

Tl =Thermistor(Outdoor Liquid Temperature)  
 Td =Thermistor(Discharge Temperature)  
 Ta =Thermistor(Outdoor Air Temperature)

HP/LP sensor= High/Low Pressure Sensor  
 HPS= High Pressure Switch  
 Tm =Thermistor(Outdoor Coil Temperature)

# SYSTEM OPERATION

## COOLING CYCLE

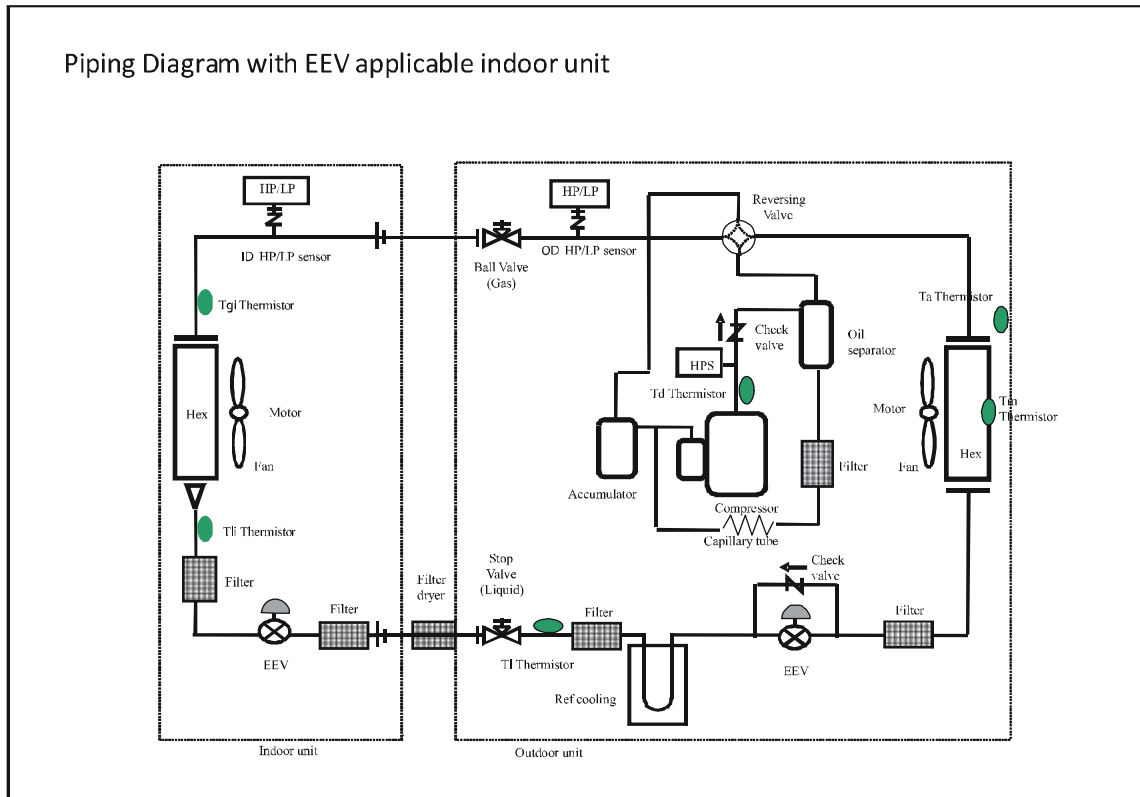

**LEGEND:**

- Tl = Thermistor (Outdoor Liquid Temperature)
- Td = Thermistor (Discharge Temperature)
- Ta = Thermistor (Outdoor Air Temperature)
- Tm = Thermistor (Outdoor Coil Temperature)

- Tli = Thermistor (Indoor Liquid Temperature)
- Tgi = Thermistor (Indoor Gas Temperature)
- ID HP/LP sensor = Indoor High/Low Pressure Sensor
- OD HP/LP sensor = Outdoor High/Low Pressure Sensor
- HPS = High Pressure Switch

# SERVICING

## CHECKING VOLTAGE

1. Remove outer case, control panel cover, etc., from unit being tested.

With power ON:



 <b>WARNING</b>
<b>LINE VOLTAGE NOW PRESENT.</b>

2. Using a voltmeter, measure the voltage across terminals L1 and L2 of the contactor for the Air Conditioner condenser unit or at the field connections for the air handler or heaters.  
**ComfortNet™ Ready Air Conditioner Condenser Units:** Measure the voltage across the L1 and L2 lugs on the unitary (UC) control.
3. No reading - indicates open wiring, open fuse(s) no power or etc., from unit to fused disconnect service. Repair as needed.
4. With ample voltage at line voltage connectors, energize the unit.

Unit Type	Unit Supply Voltage (VAC)		
	voltage	min.	max.
Outdoor Unit, Air Handler, Modular Blower, Heater Kit	208/230	197	253
Gas Furnaces	115	103	126

**NOTE:** When operating electric heaters on voltages other than 240 volt, refer to the System Operation section on electric heaters to calculate temperature rise and air flow. Low voltage may cause insufficient heating.

## CHECKING WIRING

 <b>WARNING</b>	
<b>HIGH VOLTAGE</b> <b>DISCONNECT ALL POWER BEFORE SERVICING OR INSTALLING THIS UNIT. MULTIPLE POWER SOURCES MAY BE PRESENT. FAILURE TO DO SO MAY CAUSE PROPERTY DAMAGE, PERSONAL INJURY OR DEATH.</b>	

1. Check wiring visually for signs of overheating, damaged insulation and loose connections.
2. Use an ohmmeter to check continuity of any suspected open wires.
3. If any wires must be replaced, replace with comparable gauge and insulation thickness.

## CHECKING THERMOSTAT AND WIRING

Communicating Thermostat Wiring: The maximum wire length for 18 AWG thermostat wire is 250 feet.

## THERMOSTAT AND WIRING

 <b>WARNING</b>
<b>LINE VOLTAGE NOW PRESENT.</b>

With power ON, thermostat calling for cooling/heating.

1. Use a voltmeter to check for 24 volt at thermostat wires C and R in the indoor unit control panel.
2. No voltage indicates trouble in the thermostat, wiring or transformer source.
3. Check the continuity of the thermostat and wiring. Repair or replace as necessary.

 <b>WARNING</b>
<b>LINE VOLTAGE NOW PRESENT.</b>

## RESISTANCE HEATERS

With power ON:

1. Set room thermostat to a higher setting than room temperature so both stages call for heat.
2. With voltmeter, check for 24 volt at each heater relay.
3. No voltage indicates the trouble is in the thermostat or wiring.
4. Check the continuity of the thermostat and wiring. Repair or replace as necessary.

**NOTE:** Consideration must be given to how the heaters are wired (O.D.T. and etc.). Also safety devices must be checked for continuity.

## THERMOSTAT COMFORTBRIDGE™ SYSTEM

### OVERVIEW

The ComfortBridge based inverter heating and air conditioning system uses an indoor unit and outdoor unit digitally communicating with one another via a two-way communications path.

The 24 VAC single-stage thermostat sends commands to the indoor and outdoor units.

The indoor and outdoor units interacting with one another directly while taking simple analog commands from the thermostat are the core of unlocking the benefits and features of the ComfortBridge control system.

**NOTE:** It is **strongly** recommend the use of thermostat with humidity sensor and dehumidification terminal. Without these functions, Dehumidification operation does not work.

# SERVICING

## COMFORTBRIDGE™ SYSTEM WIRING

ComfortBridge™ control system is low voltage wiring consists of two wires between the indoor unit and outdoor unit.

The required wires are data lines 1 and 2.

The thermostat needs 4 wires between the indoor unit and thermostat or 5 wires if the thermostat requires a Common wire.

**NOTE:** Regarding the wiring of the indoor unit to the thermostat, also refer to ComfortBridge™ compatible indoor unit's install manual (in case of communicating inverter system).

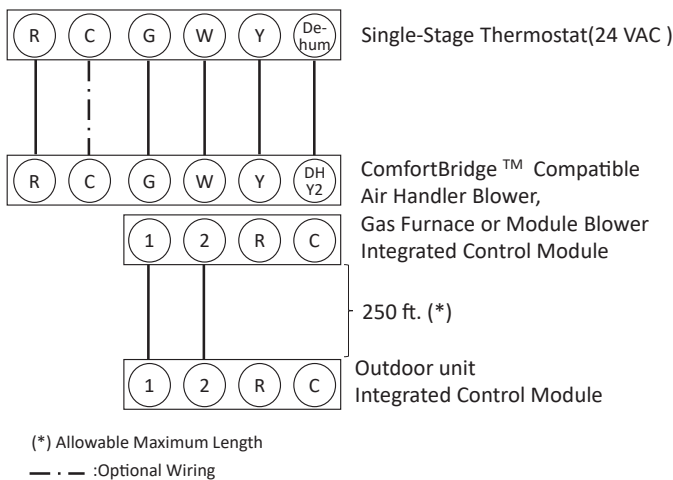

SYSTEM WIRING

## CHECKING TRANSFORMER AND CONTROL CIRCUIT

	<b>WARNING</b>
<p><b>HIGH VOLTAGE</b> DISCONNECT ALL POWER BEFORE SERVICING OR INSTALLING THIS UNIT. MULTIPLE POWER SOURCES MAY BE PRESENT. FAILURE TO DO SO MAY CAUSE PROPERTY DAMAGE, PERSONAL INJURY OR DEATH.</p>	

A step-down transformer (208/230 volt primary to 24 volt secondary) is provided with each indoor unit. This allows ample capacity for use with resistance heaters. The outdoor sections do not contain a transformer (see note below). (see indoor unit WIRING DIAGRAM)

	<b>WARNING</b>
<p><b>DISCONNECT ALL POWER BEFORE SERVICING.</b></p>	

1. Remove control panel cover, or etc., to gain access to transformer.

With power ON:

	<b>WARNING</b>
<p><b>LINE VOLTAGE NOW PRESENT.</b></p>	

2. Using a voltmeter, check voltage across secondary voltage side of transformer (R to C).
3. No voltage indicates faulty transformer, bad wiring, or bad splices.
4. Check transformer primary voltage at incoming line voltage connections and/or splices.
5. If line voltage available at primary voltage side of transformer and wiring and splices good, transformer is inoperative. Replace.

## CHECKING HIGH PRESSURE SWITCH

	<b>WARNING</b>
<p><b>HIGH VOLTAGE</b> DISCONNECT ALL POWER BEFORE SERVICING OR INSTALLING THIS UNIT. MULTIPLE POWER SOURCES MAY BE PRESENT. FAILURE TO DO SO MAY CAUSE PROPERTY DAMAGE, PERSONAL INJURY OR DEATH.</p>	

The high pressure switch senses the pressure in the compressor discharge line. If abnormally high condensing pressures develop, the contacts of the control open, breaking the control circuit before the compressor motor overloads. This control is automatically reset.

1. Using an ohmmeter, check across the X32A connection on outdoor unit PCB high pressure control, with wire removed. If not continuous, the contacts are open.
2. Attach a gauge to the dill valve port on the base valve.

With power ON:

	<b>WARNING</b>
<p><b>LINE VOLTAGE NOW PRESENT.</b></p>	

3. Start the system in charge mode and place a piece of cardboard in front of the outdoor coil, raising the condensing pressure.
4. Check pressure at which the high pressure control cuts-out. If it cuts-out at 605 PSIG to -17 PSIG, it is operating normally (See causes for high head pressure in Service Problem Analysis Guide). If it cuts out below this pressure range, replace the control.

## CHECKING OUTDOOR HI/LOW PRESSURE SENSOR

	<b>WARNING</b>
<p><b>LINE VOLTAGE NOW PRESENT.</b></p>	

# SERVICING

The HI/LOW pressure sensor senses the suction pressure in cooling mode, and the discharge pressure in heating mode. Follow the following sequence to check the pressure sensor.

1. Connect manifold gauge to the air conditioner unit
2. Connect a pair of extended Molex probe tips to your voltmeter test leads.
3. Find the suction pressure in the cool mode, or discharge pressure in the heat mode. Locate (X17A) connection and connect a DC voltmeter across sensor terminals 1 and 3, (black and white wires) and record the DC voltage.
4. Compare your readings to the detected pressure vs output voltage in the following table. Replace the sensor if the sensor is open, shorted, or outside of the voltage range.

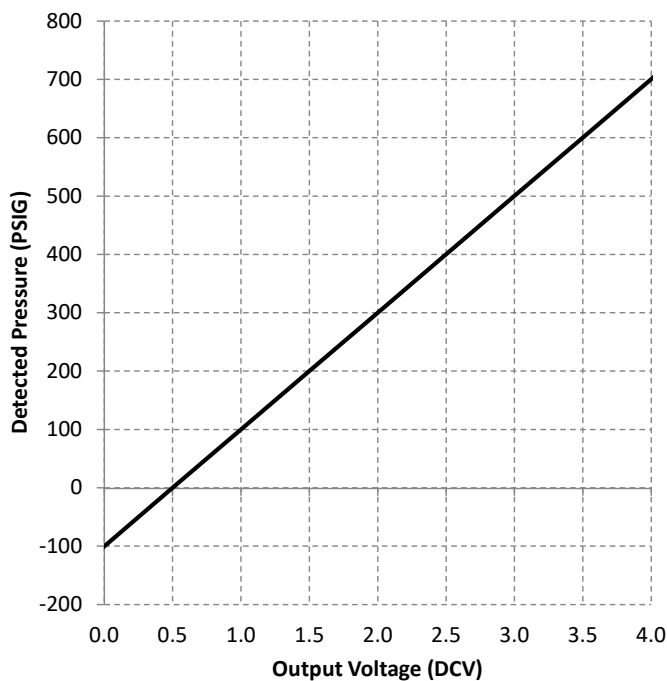

**VOLTAGE AND PRESSURE CHARACTERISTICS**

## RESISTANCE CHECK (5 TON ONLY)

**WARNING**

**HIGH VOLTAGE**  
 DISCONNECT ALL POWER BEFORE SERVICING OR INSTALLING THIS UNIT. MULTIPLE POWER SOURCES MAY BE PRESENT. FAILURE TO DO SO MAY CAUSE PROPERTY DAMAGE, PERSONAL INJURY OR DEATH.

1. Discharge capacitor and remove wire leads.

**WARNING**

**DISCHARGE CAPACITOR THROUGH A 20 TO 30 OHM RESISTOR BEFORE HANDLING.**

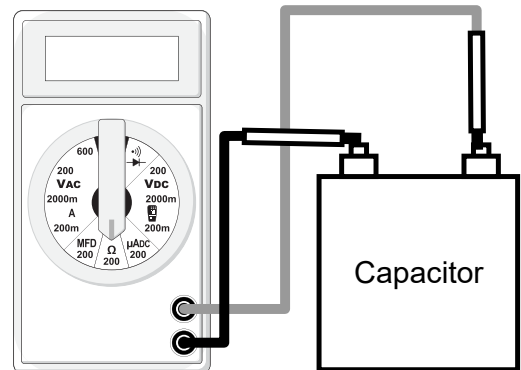

**TESTING CAPACITOR RESISTANCE**

2. Set an ohmmeter on its highest ohm scale and connect the leads to the capacitor.
  - A. Good Condition - indicator swings to zero and slowly returns to infinity. (Start capacitor with bleed resistor will not return to infinity. It will still read the resistance of the resistor).
  - B. Shorted - indicator swings to zero and stops there - replace.
  - C. Open - no reading - replace. (Start capacitor would read resistor resistance.)

## CAPACITANCE CHECK (5 TON ONLY)

Using a hookup as shown below, take the amperage and voltage readings and use them in the formula:

$$\text{Capacitance (MFD)} = \frac{2650 \times \text{Amperage}}{\text{Voltage}}$$

**WARNING**

**DISCHARGE CAPACITOR THROUGH A 20 TO 30 OHM RESISTOR BEFORE HANDLING.**

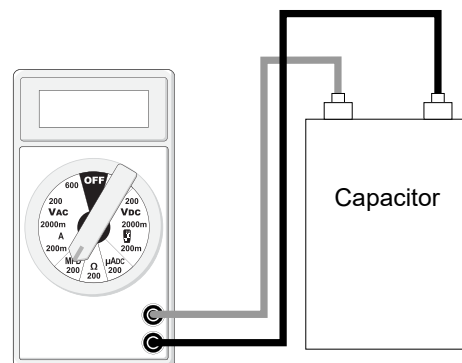

**TESTING CAPACITANCE**

# SERVICING

## CHECKING COMPRESSOR



### WARNING

HERMETIC COMPRESSOR ELECTRICAL TERMINAL VENTING CAN BE DANGEROUS. WHEN INSULATING MATERIAL WHICH SUPPORTS A HERMETIC COMPRESSOR OR ELECTRICAL TERMINAL SUDDENLY DISINTEGRATES DUE TO PHYSICAL ABUSE OR AS A RESULT OF AN ELECTRICAL SHORT BETWEEN THE TERMINAL AND THE COMPRESSOR HOUSING, THE TERMINAL MAY BE EXPELLED, VENTING THE VAPOR AND LIQUID CONTENTS OF THE COMPRESSOR HOUSING AND SYSTEM.

If the compressor terminal PROTECTIVE COVER and gasket (if required) are not properly in place and secured, there is a remote possibility if a terminal vents, that the vaporous and liquid discharge can be ignited, spouting flames several feet, causing potentially severe or fatal injury to anyone in its path.

This discharge can be ignited external to the compressor if the terminal cover is not properly in place and if the discharge impinges on a sufficient heat source.

Ignition of the discharge can also occur at the venting terminal or inside the compressor, if there is sufficient contaminant air present in the system and an electrical arc occurs as the terminal vents.

Ignition cannot occur at the venting terminal without the presence of contaminant air, and cannot occur externally from the venting terminal without the presence of an external ignition source.

Therefore, proper evacuation of a hermetic system is essential at the time of manufacture and during servicing. To reduce the possibility of external ignition, all open flame, electrical power, and other heat sources should be extinguished or turned off prior to servicing a system.

## COMPRESSOR WINDING INSULATION TEST

The Inverter on the outdoor control board takes the position signal from the UVW line, connected with the compressor. If the system detects a malfunction on the compressor, check the insulation resistance in accordance with the following procedure.



### WARNING

**HIGH VOLTAGE**  
DISCONNECT ALL POWER BEFORE SERVICING OR INSTALLING THIS UNIT. MULTIPLE POWER SOURCES MAY BE PRESENT. FAILURE TO DO SO MAY CAUSE PROPERTY DAMAGE, PERSONAL INJURY OR DEATH.



1. Remove the leads from the compressor terminals.
2. Using a Megometer, attach one lead to ground.
3. Using the other lead of the Megometer, check the insulation between U to ground, V to ground, W to ground.

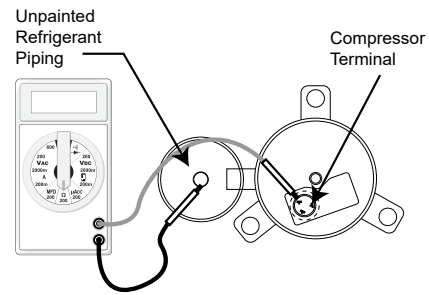

## TESTING COMPRESSOR WINDINGS INSULATION

**NOTE:** The 2, 3, and 4 ton compressor has a terminal on the top. The 5 ton compressor has the terminals on the side. If the insulation resistance of the compressor is less than 100k Ohms between U to ground, V to ground, W to ground, replace the compressor.

## GROUND TEST

If fuse, circuit breaker, ground fault protective device, etc., has tripped, this is a strong indication that an electrical problem exists and must be found and corrected. The circuit protective device rating must be checked, and its maximum rating should coincide with that marked on the equipment nameplate.

With the terminal protective cover in place, it is acceptable to replace the fuse or reset the circuit breaker ONE TIME ONLY to see if it was just a nuisance opening. If it opens again, DO NOT continue to reset.

Disconnect all power to unit, making sure that all power legs are open.

1. DO NOT remove protective terminal cover. Disconnect the three leads going to the compressor terminals at the nearest point to the compressor.
2. Identify the leads and using an ohmmeter on the R x 10,000 scale or the highest resistance scale on your ohmmeter check the resistance between each of the three leads separately to ground (such as an unpainted tube on the compressor).
3. If a ground is indicated, then carefully remove the compressor terminal protective cover and inspect for loose leads or insulation breaks in the lead wires.
4. If no visual problems indicated, carefully remove the leads at the compressor terminals.
5. Carefully retest for ground, directly between compressor terminals and ground.
6. If ground is indicated, replace the compressor. The resistance reading should be infinity. If there is any reading on meter, there is some continuity to ground and compressor should be considered defective.



# SERVICING

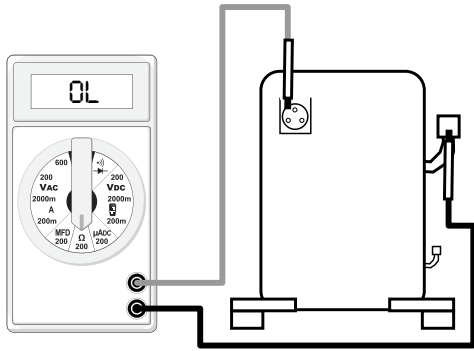

**WARNING**

**DAMAGE CAN OCCUR TO THE GLASS EMBEDDED TERMINALS IF THE LEADS ARE NOT PROPERLY REMOVED. THIS CAN RESULT IN TERMINAL AND HOT OIL DISCHARGING.**

## TESTING CRANKCASE HEATER (5 TON ONLY)

The crankcase heater must be energized a minimum of 2 hours before the unit is operated. Crankcase heaters are used to prevent migration or accumulation of refrigerant in the compressor crankcase during the off cycles and prevents liquid slugging or oil pumping on start up. A crankcase heater will not prevent compressor damage due to a flood-back or over charge condition.

**WARNING**

**DISCONNECT ALL POWER BEFORE SERVICING.**

1. Disconnect the heater lead in wires.
2. Using an ohmmeter, check heater continuity - should test continuous. If not, replace.

**NOTE:** The positive temperature coefficient crankcase heater is a 33 watt 240 voltage heater. The cool resistance of the heater will be approximately 1745 ohms. The resistance will become greater as the temperature of the compressor shell increases.

## TESTING TEMPERATURE SENSORS AND EEV COIL RESISTANCE

The \*SXV9 outdoor units and AMVE\*\* indoor units are factory equipped with:

- (Ta) an outdoor air temperature sensor
- (Tm) an outdoor coil temperature sensor
- (Tl) an outdoor liquid temperature sensor
- (Td) a discharge temperature sensor
- (Tgi) an indoor gas temperature sensor
- (Tli) an indoor liquid temperature sensor

To check above sensors:

**WARNING**

**HIGH VOLTAGE**  
**DISCONNECT ALL POWER BEFORE SERVICING OR INSTALLING THIS UNIT. MULTIPLE POWER SOURCES MAY BE PRESENT. FAILURE TO DO SO MAY CAUSE PROPERTY DAMAGE, PERSONAL INJURY OR DEATH.**

1. Disconnect power to the Air Conditioner condenser.
2. Disconnect the sensor from the electric board.
3. Connect an ohmmeter across the sensor terminals. The ohmmeter should read be the resistance shown in the table THERMISTOR RESISTANCE AND TEMPERATURE CHARACTERISTICS CHART (page 31). Replace the sensor if the sensor is open, shorted, or outside the valid resistance range.

## TESTING EEV COIL RESISTANCE

To check the resistance of the EEV coil, first disconnect EEV cable from the PCB board. Make measurements of resistance between the connector pins, and then make sure the resistance falls in the range of 40 to 50 Ω.

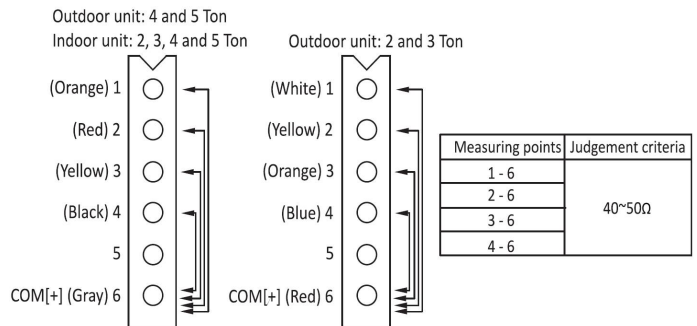

## AMVE HEATER CONTROL (OPTIONAL)

### DESCRIPTION

The AMVE models utilize an electronic control that provides ECM blower motor control and control of up to two electric heat sequencers. The control has thermostat inputs for up to two stages of cooling, two stages of electric heat, reversing valve, and dehumidification. Control input is 24VAC.

### TROUBLESHOOTING

### MOTOR CONTROL CIRCUITS

**WARNING**

**HIGH VOLTAGE**  
**DISCONNECT ALL POWER BEFORE SERVICING OR INSTALLING THIS UNIT. MULTIPLE POWER SOURCES MAY BE PRESENT. FAILURE TO DO SO MAY CAUSE PROPERTY DAMAGE, PERSONAL INJURY OR DEATH.**



# SERVICING

1. Turn on power to air handler or modular.

 <b>WARNING</b>
<b>LINE VOLTAGE NOW PRESENT.</b>

2. Check voltage between pins 1 and 4 at the 4-wire motor connector on the control board. Voltage should be between 9 and 15 VDC. Replace control if voltage is not as specified.

## ELECTRIC HEAT SEQUENCER OUTPUTS

 <b>WARNING</b>	
<b>HIGH VOLTAGE</b> DISCONNECT ALL POWER BEFORE SERVICING OR INSTALLING THIS UNIT. MULTIPLE POWER SOURCES MAY BE PRESENT. FAILURE TO DO SO MAY CAUSE PROPERTY DAMAGE, PERSONAL INJURY OR DEATH.	

1. Turn on power to air handler or modular blower.

 <b>WARNING</b>
<b>LINE VOLTAGE NOW PRESENT.</b>

2. Disconnect the 4-circuit harness connecting the control to the electric heater kit.
3. Provide a thermostat demand for low stage auxiliary heat. Measure the voltage between pins 1 and 3 at the onboard electric heat connector. Voltage should measure 24VAC. Replace control if no voltage is present.

**NOTE:** Allow for any built-in time delays before making voltage measurements. Any electric heater faults that are present may prevent the heater output from energizing. Verify that no heater faults are present before making voltage measurements.

4. Provide a thermostat demand for high stage auxiliary heat (W1 + W2). Measure the voltage between pins 1 and 3 at the on-board electric heat connector. Measure the voltage between pins 2 and 3 at the on-board electric heat connector. Voltage should measure 24VAC. Replace control if no voltage is present.

The integrated air handler control has some on-board tools that may be used to troubleshoot the network. These tools are: red communications LED, green receive (Rx) LED, and learn button. These are described below

- a. Red communications LED – Indicates the status of the network. Refer to the Network Troubleshooting Chart for the LED status and the corresponding potential problem.

- b. Green receive LED – Indicates network traffic. Refer to the Network Troubleshooting Chart for the LED status and the corresponding potential problem.
- c. Learn button – Used to reset the network. Depress the button for approximately 2 seconds to reset the network.



For details, see NETWORK TROUBLESHOOTING section.

 <b>WARNING</b>
<b>DISCONNECT ALL POWER BEFORE SERVICING.</b>

## REFRIGERATION REPAIR PRACTICE

 <b>DANGER</b>
<b>ALWAYS REMOVE THE REFRIGERANT CHARGE IN A PROPER MANNER BEFORE APPLYING HEAT TO THE SYSTEM.</b>

When repairing the refrigeration system:

 <b>WARNING</b>	
<b>HIGH VOLTAGE</b> DISCONNECT ALL POWER BEFORE SERVICING OR INSTALLING THIS UNIT. MULTIPLE POWER SOURCES MAY BE PRESENT. FAILURE TO DO SO MAY CAUSE PROPERTY DAMAGE, PERSONAL INJURY OR DEATH.	

1. Never open a system that is under vacuum. Air and moisture will be drawn in.
2. Plug or cap all openings.
3. Remove all burrs and clean the brazing surfaces of the tubing with sand cloth or paper. Brazing materials do not flow well on oxidized or oily surfaces.
4. Clean the inside of all new tubing to remove oils and pipe chips.
5. When brazing, sweep the tubing with dry nitrogen to prevent the formation of oxides on the inside surfaces.
6. Complete any repair by replacing the liquid line drier in the system, evacuate and charge.

## BRAZING MATERIALS

**IMPORTANT NOTE:** Torch heat required to braze tubes of various sizes is proportional to the size of the tube. Tubes of smaller size require less heat to bring the tube to brazing temperature before adding brazing alloy. Applying too much heat to any tube can melt the tube. Service personnel must use the appropriate heat level for the size of the tube being brazed.



**NOTE:** The use of a heat shield when brazing is recommended to avoid burning the serial plate or the finish on the unit. Heat trap or wet rags should be used to protect heat sensitive components such as stop valves, EEV, TXV and filters.

# SERVICING

Copper to Copper Joints - Sil-Fos used without flux (alloy of 15% silver, 80% copper, and 5% phosphorous). Recommended heat 1400°F.

Copper to Steel Joints - Silver Solder used without a flux (alloy of 30% silver, 38% copper, 32% zinc). Recommended heat - 1200°F.

## LEAK TESTING (NITROGEN OR NITROGEN-TRACED)

 <b>WARNING</b>
<b>TO AVOID THE RISK OF FIRE OR EXPLOSION, NEVER USE OXYGEN, HIGH PRESSURE AIR OR FLAMMABLE GASES FOR LEAK TESTING OF A REFRIGERATION SYSTEM.</b>
 <b>WARNING</b>
<b>TO AVOID POSSIBLE EXPLOSION, THE LINE FROM THE NITROGEN CYLINDER MUST INCLUDE A PRESSURE REGULATOR AND A PRESSURE RELIEF VALVE. THE PRESSURE RELIEF VALVE MUST BE SET TO OPEN AT NO MORE THAN 450 PSIG.</b>

## LEAK TESTING

Leak test the system using dry nitrogen and soapy water to identify leaks. If you prefer to use an electronic leak detector, charge the system to **10 PSIG** with the appropriate system refrigerant (see Serial Data Plate for refrigerant identification). Do not use an alternative refrigerant. Using dry nitrogen finish charging the system to **450 PSIG**. Apply the leak detector to all suspect areas. When leaks are discovered, repair the leaks, and repeat the pressure test. If leaks have been eliminated proceed to system evacuation.

## STANDING PRESSURE TEST

Using dry nitrogen, pressurize the system to **450 PSIG**. Allow the pressure to stabilize and hold for 15 minutes (minimum). If the pressure does not drop below **450 PSIG** the system is considered leak free. Proceed to system evacuation using the Deep Vacuum Method. If after 15 minutes the pressure drops below **450 PSIG** follow the procedure outlined below to identify system leaks. Repeat the Standing Pressure Test.

## SYSTEM EVACUATION

 <b>WARNING</b>
<b>REFRIGERANT UNDER PRESSURE! FAILURE TO FOLLOW PROPER PROCEDURES MAY CAUSE PROPERTY DAMAGE, PERSONAL INJURY OR DEATH.</b>

**IMPORTANT NOTE:** Because of the potential damage to compressors, do not allow suction pressure at service valve to drop below 5 PSIG when pumping unit system down for repair. Outdoor section, depending on line set length and amount of charge in system, may not be able to hold the entire system charge.

This is the most important part of the entire service procedure. The life and efficiency of the equipment is dependent upon the thoroughness exercised by the serviceman when evacuating air (non-condensables) and moisture from the system.

Air in a system causes high condensing temperature and pressure, resulting in increased power input and reduced performance.

Moisture chemically reacts with the refrigerant oil to form corrosive acids. These acids attack motor windings and parts, causing breakdown.

The equipment required to thoroughly evacuate the system is a vacuum pump, capable of producing a vacuum equivalent to 500 microns absolute and a micron gauge to give a true reading of the vacuum in the system

**NOTE:** Never use the system compressor as a vacuum pump or run when under a high vacuum. Motor damage could occur.

Condensing unit liquid and suction valves are closed to contain the charge within the unit. The unit is shipped with the valve stems closed and caps installed. Do not open valves until the system is evacuated.

## DEEP VACUUM METHOD

The **Deep Vacuum Method** requires a vacuum pump rated for 500 microns or less. This method is an effective and efficient way of assuring the system is free of non-condensable air and moisture. As an alternative, the **Triple Evacuation Method** may be used.

It is recommended to remove the Schrader Cores from the service valves using a core-removal tool to expedite the evacuation procedure.

Connect the vacuum pump, micron gauge, and vacuum rated hoses to both service valves. Evacuation must use both service valves to eliminate system mechanical seals. Evacuate the system to less than 500 microns.

Isolate the pump from the system and hold vacuum for 10 minutes (minimum). Typically, pressure will rise slowly during this period. If the pressure rises to less than 1000 microns and remains steady, the system is considered leak-free; proceed to system charging and startup.

## SERVICING

If pressure rises above 1000 microns but holds steady below 2000 microns, non-condensable air or moisture may remain or a small leak is present. Return to step 2: If the same result is achieved check for leaks and repair. Repeat the evacuation procedure.

If pressure rises above 2000 microns, a leak is present. Check for leaks and repair. Repeat the evacuation procedure.

### TRIPLE EVACUATION METHOD (ALTERNATE TO DEEP VACUUM METHOD)

1. Evacuate the system to 4000 microns and hold for 15 minutes. Then, break the vacuum with dry nitrogen, bring the system pressure up to 2-3 PSIG, and hold for 20 minutes. Release the nitrogen.
2. Evacuate to 1500 microns and hold for 20 minutes. Break the vacuum with dry nitrogen again, bring the system pressure back up to 2-3 PSIG, and hold for 20 minutes.
3. Then, evacuate the system until it is below 500 microns and hold for 60 minutes.



### WARNING

DO NOT FRONT SEAT THE SERVICE VALVE(S) WITH THE COMPRESSOR OPEN, WITH THE SUCTION LINE OF THE COMPRESSOR CLOSED OR SEVERELY RESTRICTED.

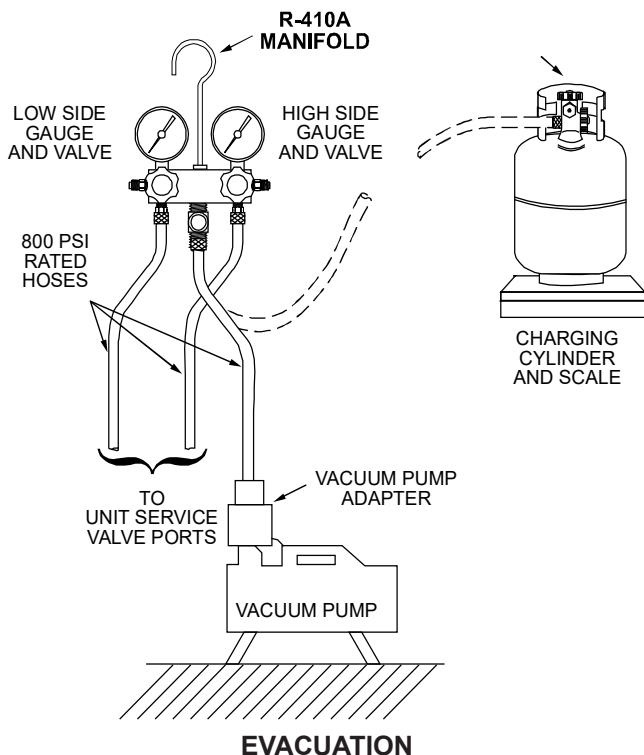

## CHARGING



### WARNING

#### REFRIGERANT UNDER PRESSURE!

- DO NOT OVERCHARGE SYSTEM WITH REFRIGERANT.
- DO NOT OPERATE UNIT IN A VACUUM OR AT NEGATIVE PRESSURE.

FAILURE TO FOLLOW PROPER PROCEDURES MAY CAUSE PROPERTY DAMAGE, PERSONAL INJURY OR DEATH.



### CAUTION

USE REFRIGERANT CERTIFIED TO AHRI STANDARDS. USED REFRIGERANT MAY CAUSE COMPRESSOR DAMAGE AND IS NOT COVERED BY THE WARRANTY. MOST PORTABLE MACHINES CANNOT CLEAN USED REFRIGERANT TO MEET AHRI STANDARDS.



### CAUTION

DAMAGE TO THE UNIT CAUSED BY OPERATING THE COMPRESSOR WITH THE SUCTION VALVE CLOSED IS NOT COVERED UNDER THE WARRANTY AND MAY CAUSE SERIOUS COMPRESSOR DAMAGE.

Charge the system with the exact amount of refrigerant. See the Installation Manual for the correct refrigerant charge.

An inaccurately charged system will cause future problems.

1. When using an ambient compensated calibrated charging cylinder, allow liquid refrigerant only to enter the high side.
2. Once the system stops taking refrigerant, close the valve on the high side of the charging manifold.
3. Start the system and charge the balance of the refrigerant through the low side.

**NOTE:** R410A should be drawn out of the storage container or drum in liquid form due to its fractionation properties, but should be "Flashed" to its gas state before entering the system. There are commercially available restriction devices that fit into the system charging hose set to accomplish this. DO NOT charge liquid R410A into the compressor.

4. With the system still running, close the valve on the charging cylinder. At this time, you may still have some liquid refrigerant in the charging cylinder hose and will definitely have liquid in the liquid hose. Reseat the liquid line core. Slowly open the high side manifold valve and transfer the liquid refrigerant from the liquid line hose and charging cylinder hose into the suction service valve port. CAREFUL: Watch so that liquid refrigerant does not enter the compressor.

### FINAL CHARGE ADJUSTMENT

The outdoor temperature must be 65°F to 105°F. If outdoor ambient temperature is out of range, charge defined amount and don't adjust subcooling. Set the room thermostat to CHARGE mode.

# SERVICING

After system has stabilized per startup instructions, check subcooling as detailed in the following section. In the event of system overcharge or undercharge, refrigerant in the system must be adjusted to the appropriate subcooling and superheat as specified in the following sections. Refrigerant amount should be adjusted within +/- 0.5 lb. if the outdoor ambient temperature is greater than 65°F and less than 105°F. Manufacturer recommends that the system should be evacuated and should be charged the initial refrigerant for given line length when the ambient temperature is less than 65°F and more than 105°F. Refer to the Installation Manual to calculate refrigerant amount.

5. With the system still running, remove hose and reinstall both valve caps.
6. Check system for leaks.

**NOTE:** Subcooling information is valid only while the unit is operating at 100% capacity or 100% of compressor speed in CHARGE MODE. Compressor speed is displayed under STATUS menu in the thermostat.

## CHECKING COMPRESSOR EFFICIENCY

The reason for compressor inefficiency is that the compressor is broken or damaged, reducing the ability of the compressor to pump refrigerant vapor.

The condition of the compressor is checked in the following manner.

1. Attach gauges to the high and low side of the system.
2. Start the system and run CHARGE MODE.

If the test shows:

- a. Below normal high side pressure.
- b. Above normal low side pressure.
- c. Low temperature difference across coil.
- d. Low amp draw at compressor.

And the charge is correct. The compressor is faulty - replace the compressor.

## THERMOSTATIC EXPANSION VALVE

The expansion valve is designed to control the rate of liquid refrigerant flow into an evaporator coil in exact proportion to the rate of evaporation of the refrigerant in the coil. The amount of refrigerant entering the coil is regulated since the valve responds to temperature of the refrigerant gas leaving the coil (feeler bulb contact) and the pressure of the refrigerant in the coil. This regulation of the flow prevents the return of liquid refrigerant to the compressor.

Some TXV valves contain an internal check valve thus eliminating the need for an external check valve and bypass loop. The three forces which govern the operation of the valve are: (1) the pressure created in the power assembly

by the feeler bulb, (2) evaporator pressure, and (3) the equivalent pressure of the superheat spring in the valve. 0% bleed type expansion valves are used on indoor and outdoor coils. The 0% bleed valve will not allow the system pressures (High and Low side) to equalize during the shut down period. The valve will shut off completely at approximately 100 PSIG.

30% bleed valves used on some other models will continue to allow some equalization even though the valve has shut-off completely because of the bleed holes within the valve. This type of valve should not be used as a replacement for a 0% bleed valve, due to the resulting drop in performance.

The bulb must be securely fastened with two straps to a clean straight section of the suction line. Application of the bulb to a horizontal run of line is preferred. If a vertical installation cannot be avoided, the bulb must be mounted so that the capillary tubing comes out at the top.

THE VALVES PROVIDED BY THE MANUFACTURER ARE DESIGNED TO MEET THE SPECIFICATION REQUIREMENTS FOR OPTIMUM PRODUCT OPERATION. DO NOT USE SUBSTITUTES.

## OVERFEEDING

Overfeeding by the thermostatic expansion valve results in high suction pressure, cold suction line, and possible liquid slugging of the compressor.

If these symptoms are observed:

1. Check for an overcharged unit by referring to the cooling performance charts in the servicing section.
2. Check the operation of the power element in the valve as explained in S-110 Checking Thermostatic Expansion Valve.
3. Check for restricted or plugged equalizer tube.

## UNDERFEEDING

Underfeeding by the thermostatic expansion valve results in low system capacity and low suction pressures.

If these symptoms are observed:

1. Check for a restricted liquid line or drier. A restriction will be indicated by a temperature drop across the drier.
2. Check the operation of the power element of the valve as described in S-110 Checking Thermostatic Expansion Valve Operation.

## SUPERHEAT

The thermostatic expansion valve is factory adjusted to maintain 8°F ± 1°F degrees superheat of the suction gas. Before checking the superheat or replacing the valve, perform all the procedures outlined under Air Flow, Refrigerant Charge, Thermostatic Expansion Valve - Overfeeding, Underfeeding. These are the most common causes for evaporator malfunction.

# SERVICING

## CHECKING SUPERHEAT

Refrigerant gas is considered superheated when its temperature is higher than the saturation temperature corresponding to its pressure. The degree of superheat equals the degrees of temperature increase above the saturation temperature at existing pressure. See Temperature - Pressure Chart on following pages.

1. Run system at least 10 minutes to allow pressure to stabilize.
2. For best results, temporarily install a thermometer on the liquid line at the liquid line service valve and 4-6" from the compressor on the suction line. Ensure the thermometer makes adequate contact and is insulated for best possible readings. Use liquid line temperature to determine sub-cooling and vapor temperature to determine superheat.

**NOTE:** An optional method is to locate the thermometer at the suction line service valve. Ensure the thermometer makes adequate contact and is insulated for best possible readings.

3. Refer to the superheat table provided for proper system superheat. Add charge to lower superheat or recover charge to raise superheat.

**Superheat Formula = Suct. Line Temp. - Sat. Suct.Temp.**

**EXAMPLE:**

- a. Suction Pressure = 143 PSIG
- b. Corresponding Temp. = 50°F.
- c. Thermometer on Suction Line = 58°F.

To obtain the degrees temperature of superheat, subtract 50.0 from 58.0°F.

The difference is 8° Superheat. The 8° Superheat would fall in the ± range of allowable superheat.

## CHECKING SUBCOOLING

Refrigerant liquid is considered subcooled when its temperature is lower than the saturation temperature corresponding to its pressure. The degree of subcooling equals the degrees of temperature decrease below the saturation temperature at the existing pressure.

1. Attach an accurate thermometer or preferably a thermocouple type temperature tester to the liquid service valve as it leaves the condensing unit.
2. Install a high side pressure gauge on the high side (liquid) service valve at the front of the unit.
3. Record the gauge pressure and the temperature of the line.

4. Review the technical information manual or specification sheet for the model being serviced to obtain the design subcooling.
5. Compare the hi-pressure reading to the "Required Liquid Line Temperature" chart. Find the hi-pressure value on the left column. Follow that line right to the column under the design subcooling value. Where the two intersect is the required liquid line temperature.  
Alternately you can convert the liquid line pressure gauge reading to temperature by finding the gauge reading in the R-410A Pressure vs. Temperature Chart, find the temperature in the °F. Column.
6. The difference between the thermometer reading and pressure to temperature conversion is the amount of subcooling.

Add charge to raise subcooling. Recover charge to lower subcooling.

**Subcooling Formula = Sat. Liquid Temp. - Liquid Line Temp.**

**NOTE:** To adjust subcooling, follow the sequence of S-108.

**EXAMPLE:**

- a. Liquid Line Pressure = 417 PSIG
- b. Corresponding Temp. = 120°F.
- c. Thermometer on Liquid line = 109°F.

To obtain the amount of subcooling subtract 109°F from 120°F.

The difference is 11° subcooling. See the specification sheet or technical information manual for the design subcooling range for your unit.

There are other causes for high head pressure which may be found in the "Cooling / Heating Analysis Chart."

If other causes check out normal, an overcharge or a system containing non-condensables would be indicated. If this system is observed:

1. Start the system.
2. Remove and capture small quantities of gas from the suction line dill valve until the head pressure is reduced to normal.
3. Observe the system while running a cooling performance test. If a shortage of refrigerant is indicated, then the system contains non-condensables.

Charging Table			
OD Ambient Temp (degF)	<65°F	65°F to 105°F	>105°F
Subcooling (degF)	Weigh in Charge	2T to 5T:8°F ±1°F	Weigh in Charge

## SUPERHEAT AND SUBCOOLING ADJUSTMENT ON TXV APPLICATIONS

# SERVICING

**NOTE:** Subcooling and superheat information is valid only while the unit is operating at 100% capacity or 100% compressor speed in CHARGE MODE.

Compressor speed is displayed under STATUS menu in the thermostat.

1. Run system at least 10 minutes to allow pressure to stabilize. During the adjustment of subcooling, ambient temperature should be greater than 65°F and less than 105°F. If ambient temperature is out of range, don't adjust subcooling.
2. For best results, temporarily install a thermometer on the liquid line at the liquid line service valve and 4-6" from the compressor on the suction line. Ensure the thermometer makes adequate contact and is insulated for best possible readings. Use liquid line temperature to determine sub-cooling and vapor temperature to determine superheat.

**NOTE:** An optional method is to locate the thermometer at the suction line service valve. Ensure the thermometer makes adequate contact and is insulated for best possible readings.

3. The system subcooling should be 8°F ± 1°F. If not in that range, adjust subcooling and superheat according to the following procedure.
  - a. If subcooling and superheat are low, adjust TXV to 7 to 9°F superheat, then check subcooling.  
**NOTE:** To adjust superheat, turn the valve stem clockwise to increase and counter clockwise to decrease.
  - b. If subcooling is low and superheat is 7 to 9°F, add charge to rise subcooling to 8°F ± 1°F, then check superheat.
  - c. If subcooling is low and superheat is high, add charge to rise subcooling to 8°F ± 1°F, then check superheat.
  - d. If subcooling is 8°F ± 1°F and superheat is high, adjust the TXV valve to 7 to 9°F superheat, then check subcooling.
  - e. If subcooling and superheat are high, adjust the TXV valve to 7 to 9°F superheat, then check subcooling.
  - f. If subcooling is high and superheat is 7 to 9°F, remove charge to lower the subcooling to 8°F ± 1°F, then check superheat.
  - g. If subcooling is high and superheat is low, adjust the TXV valve to 7 to 9°F superheat and remove charge to low the subcooling to 8°F ± 1°F.
  - h. If subcooling is 8°F ± 1°F and superheat is low, adjust the TXV valve to 7 to 9°F superheat and remove charge to lower the subcooling 8°F ± 1°F, then check the superheat.

**NOTE:** It is recommended to add charge in 4 oz. increments each time to achieve the target subcooling.

4. Disconnect manifold set. Installation is complete.

# SUBCOOLING ADJUSTMENT ON EEV APPLICATIONS

**NOTE:** Subcooling information is valid only while the unit is operating at 100% capacity or 100% compressor speed in CHARGE MODE.

Compressor speed is displayed under STATUS menu in the thermostat.

1. Run system at least 20 minutes to allow pressure to stabilize. During the adjustment of subcooling, ambient temperature should be greater than 65°F and less than 105°F. If ambient temperature is out of range, don't adjust subcooling.
2. For best results, temporarily install a thermometer on the liquid line at the liquid line service valve. Ensure the thermometer makes adequate contact and is insulated for best possible readings. Use liquid line temperature to determine sub-cooling.
3. The system subcooling should fall in the range shown in following table. If not in that range, adjust subcooling according to the following procedure.
  - a. If subcooling is low, add charge to adjust the subcooling to 8°F ± 1°F.
  - b. If subcooling is high, remove charge to lower the subcooling to specified range.

**NOTE:** It is recommended to add charge in 4 oz. increments each time to achieve the target subcooling.

4. Disconnect manifold set. Installation is complete.

# CHECKING THERMOSTATIC EXPANSION VALVE OPERATION

1. Remove the remote bulb of the thermostatic expansion valve from the suction line.
2. Start the system and cool the bulb in a container of ice water, closing the valve. As you cool the bulb, the suction pressure should fall and the suction temperature will rise.
3. Next warm the bulb in your hand. As you warm the bulb, the suction pressure should rise and the suction temperature will fall.
4. If a temperature or pressure change is noticed, the expansion valve is operating. If no change is noticed, the valve is restricted, the power element is faulty, or the equalizer tube is plugged.
5. Capture the charge, replace the valve and drier, evacuate and recharge.

# NON-CONDENSABLES

If non-condensables are suspected, shut down the system and allow the pressures to equalize. Wait at least 15 minutes. Compare the pressure to the temperature of the coldest coil since this is where most of the refrigerant will be. If the pressure indicates a higher temperature than that of the coil temperature, non-condensables are present.

## SERVICING

Non-condensables are removed from the system by first removing the refrigerant charge, replacing and/or installing liquid line drier, evacuating and recharging.

### COMPRESSOR BURNOUT

When a compressor burns out, high temperature develops causing the refrigerant, oil and motor insulation to decompose forming acids and sludge.

If a compressor is suspected of being burned-out, attach a refrigerant hose to the liquid line drier valve and properly remove and dispose of the refrigerant.

**NOTICE:** Violation of EPA regulations may result in fines or other penalties.

Now determine if a burn out has actually occurred. Confirm by analyzing an oil sample using a Sporlan Acid Test Kit, AK-3 or its equivalent.

Remove the compressor and obtain an oil sample from the suction stub. If the oil is not acidic, either a burnout has not occurred or the burnout is so mild that a complete clean-up is not necessary.

If acid level is unacceptable, the system must be cleaned by using the clean-up drier method.



### CAUTION

**DO NOT ALLOW THE SLUDGE OR OIL TO CONTACT THE SKIN. SEVERE BURNS MAY RESULT.**

**NOTE:** The Flushing Method using R-11 refrigerant is no longer approved by Daikin Brand Heating-Cooling.

## REFRIGERANT PIPING

The piping of a refrigeration system is very important in relation to system capacity, proper oil return to compressor, pumping rate of compressor and cooling performance of the evaporator. A bi-flow filter drier must be brazed on by the installer onsite. Ensure the bi-flow filter drier paint finish is intact after brazing. If the paint of the steel filter drier has been burned or chipped, repaint or treat with a rust preventative. The recommended location of the filter drier is before the expansion device at the indoor unit. The liquid line must be insulated if more than 50 ft. of liquid line will pass through an area that may reach temperatures of 30°F of higher than ambient in cooling mode and/or if the temperature inside the conditioned space may reach a temperature lower than ambient in heating mode. FVC oils maintain a consistent viscosity over a large temperature range which aids in the oil return to the compressor; however, there will be some installations which require oil return traps. These installations should be avoided whenever possible, as adding oil traps to the refrigerant lines also increases the opportunity for debris and moisture to be introduced into the system. Avoid long running traps in horizontal suction line.



# SERVICING

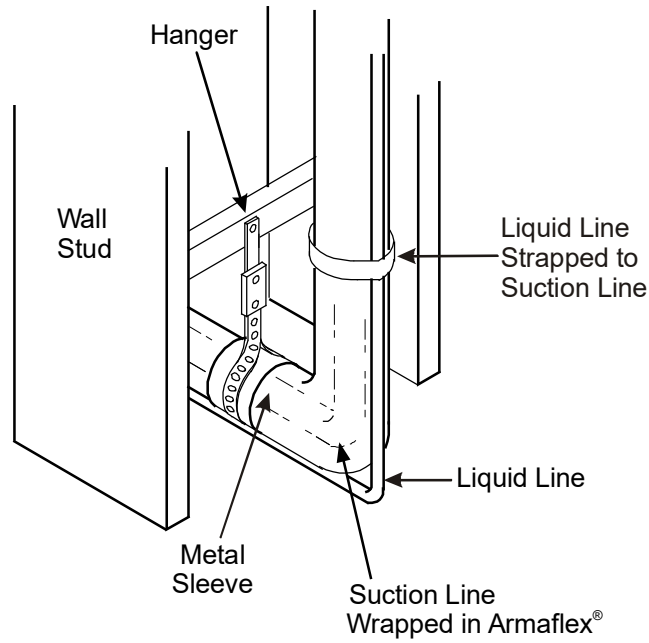

FIGURE 1-1.  
INSTALLATION OF REFRIGERATION PIPING FROM VERTICAL TO HORIZONTAL

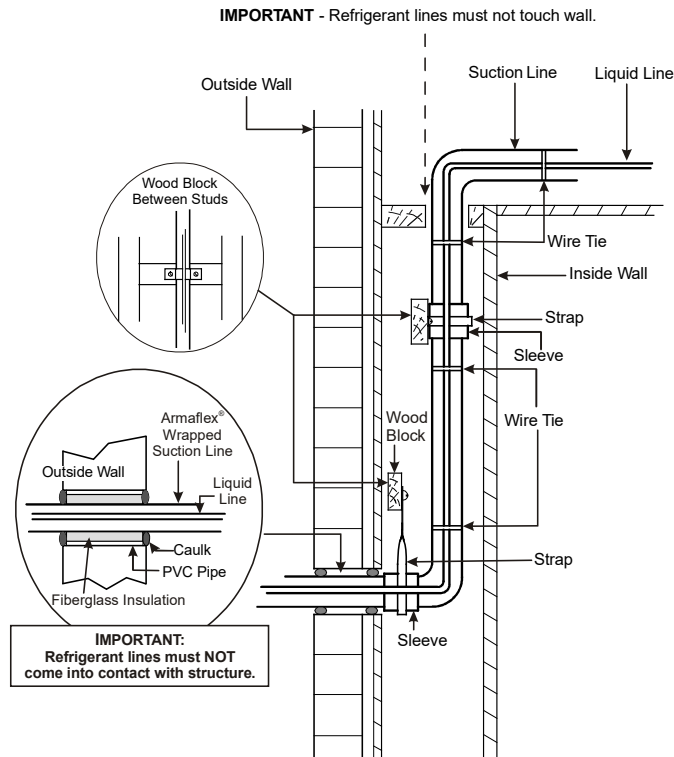
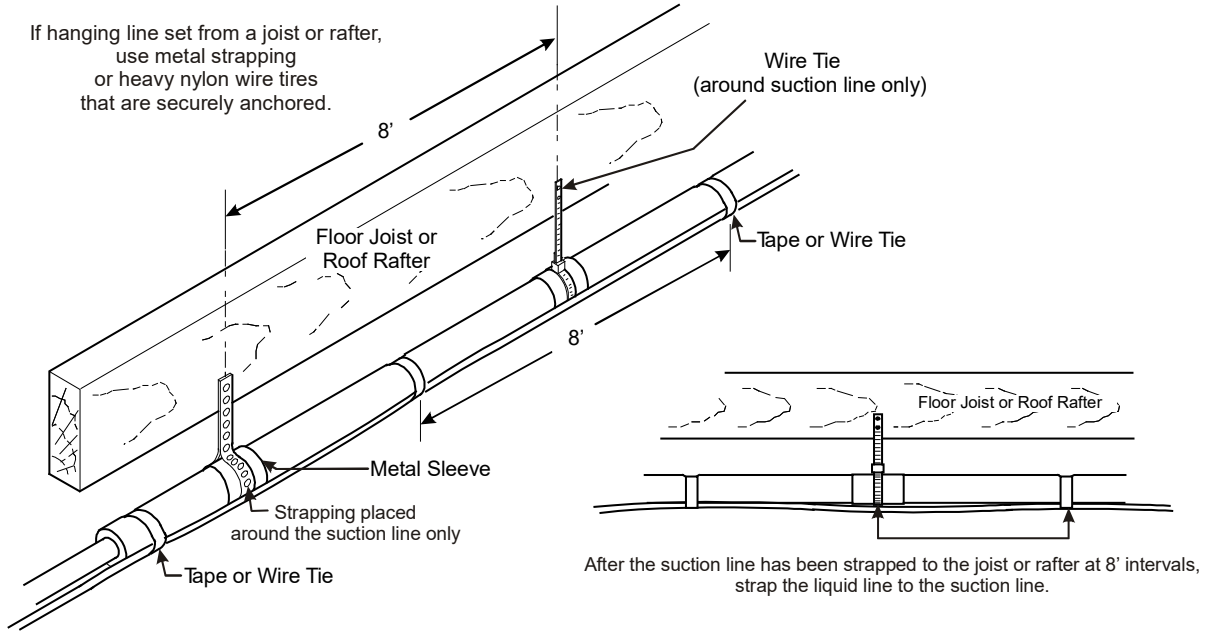

FIGURE 1-2. INSTALLATION OF REFRIGERANT PIPING (VERTICAL)  
NEW CONSTRUCTION SHOWN

**NOTE** If line set is installed on the exterior of an outside wall, similar installation practices are to be used.

# SERVICING



## SECTION 3. OUTDOOR UNIT IS ABOVE THE INDOOR UNIT



### Condenser ABOVE Evaporator

Mounting the condensing unit above the evaporator coil will require an oil trap that is vertically centered between the condensing unit and air handler IF the vertical separation exceeds 80 ft. The trap can be constructed from standard refrigerant fittings as show in the figure (bottom left).

**NOTE:** If height difference between condenser and evaporator is more than 15 ft, then refer to these diagrams.

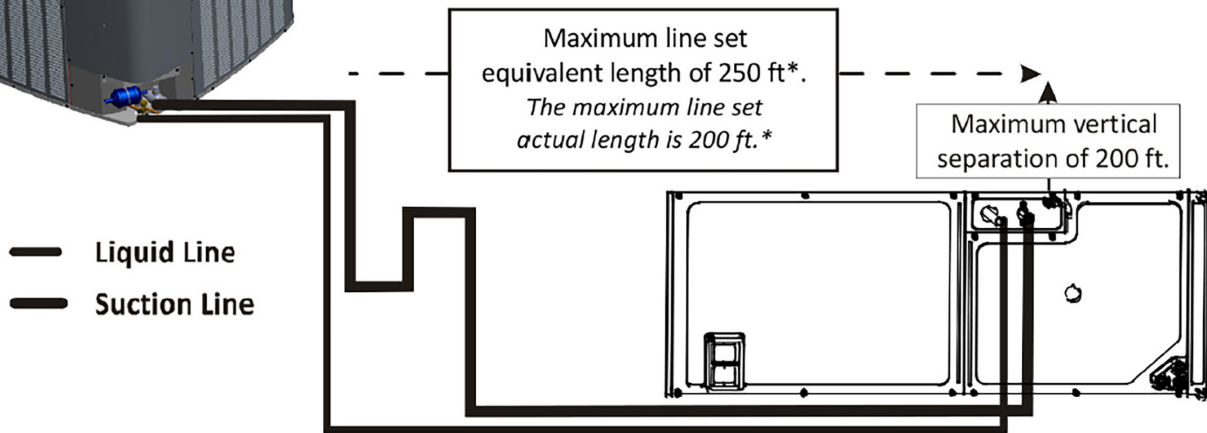

*\*Accounts for pressure losses of any elbows, bends, etc.*

1. Gas line must be sloped continuously towards the indoor unit.
2. The maximum elevation (vertical) difference between the outdoor unit and indoor unit is 200 feet.
3. The maximum line set equivalent length is 250 feet, which includes pressure losses of any elbow, bends, etc. The maximum line set actual length is 200 feet.
4. Inverted suction loop is not required at either unit.
5. An accumulator is not required for outdoor unit (accumulators are factory installed).

# SERVICING

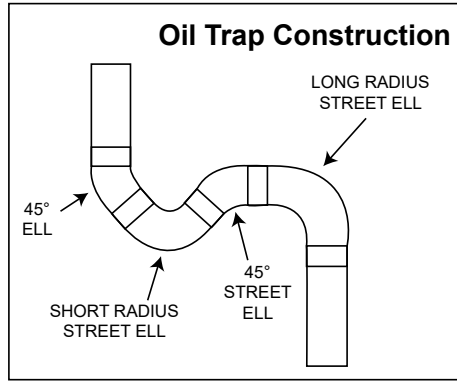

## SECTION 4. OUTDOOR UNIT IS BELOW THE INDOOR UNIT

### Condenser BELOW Evaporator

Mounting the evaporator coil above the condensing unit will require an inverted loop in the suction line adjacent or near the connection to the evaporator, for the purpose of creating an oil trap. The top of the loop must be slightly higher than the top of the coil.

**NOTE:** If Height difference between Condenser and Evaporator is more than 15 ft, then refer to these diagrams.

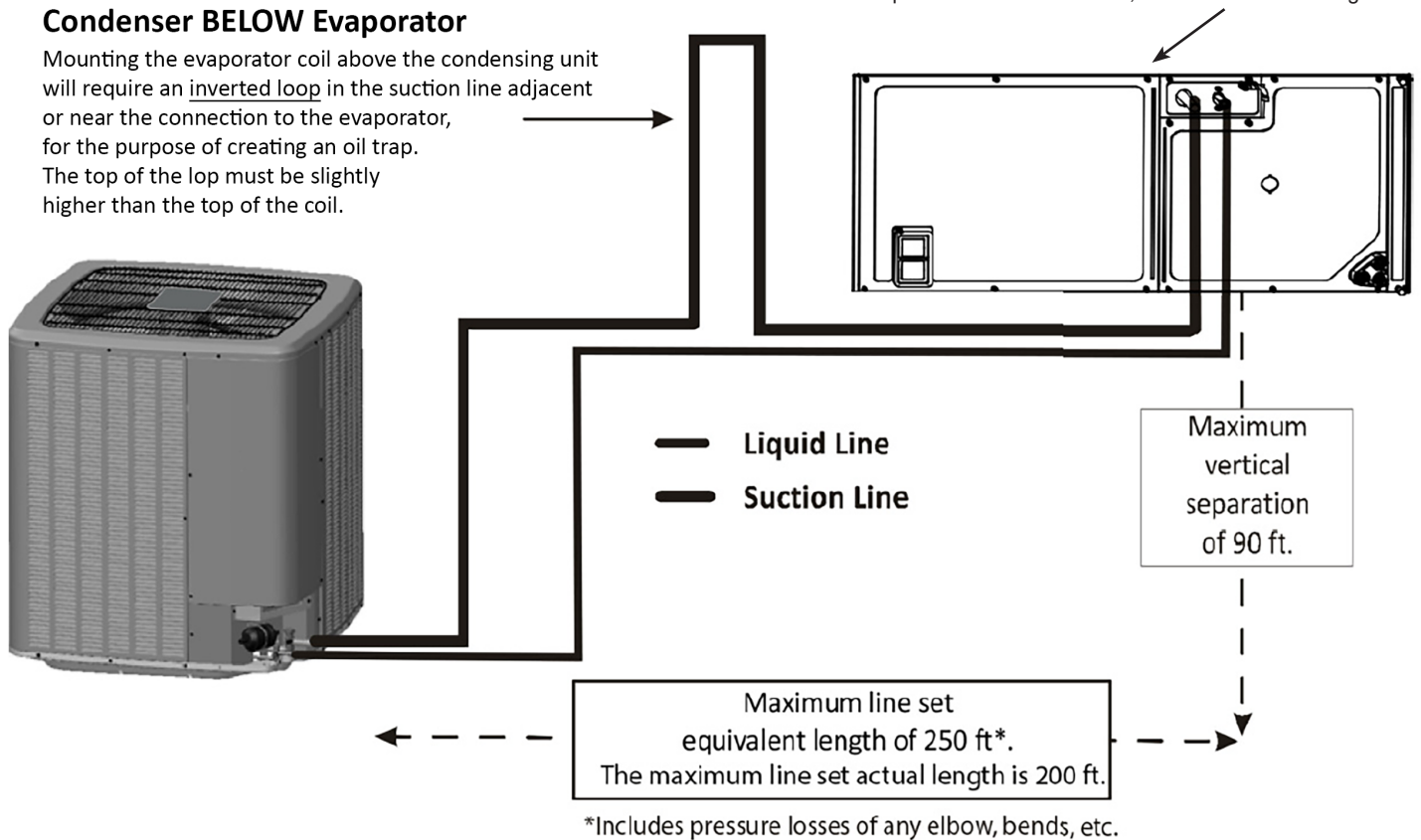

1. The maximum elevation (vertical) difference between the outdoor unit and the indoor unit is 90 feet.
2. Suction line must be installed in a manner to prevent liquid migration to the outdoor unit from the indoor unit. The Air Conditioner condenser unit is shipped with a predetermined factory charge level as shown in the following chart. For longer line sets greater than 15 feet, add 0.6 ounces of refrigerant per foot.

**NOTICE**

TOTAL REFRIGERANT =  
 FACTORY CHARGE + (0.6 OZ./FT. \* ADDITIONAL FEET  
 OF ACTUAL LINE SET).

# SERVICING

## DUCT STATIC PRESSURES AND/OR STATIC PRESSURE DROP ACROSS COILS

This minimum and maximum allowable duct static pressure for the indoor sections are found in the specifications section.

Tables are also provided for each coil, listing quantity of air (CFM) versus static pressure drop across the coil. Too great an external static pressure will result in insufficient air that can cause icing of the coil. Too much air can cause poor humidity control and condensate to be pulled off the indoor coil causing condensate leakage. Too much air can also cause motor overloading and in many cases this constitutes a poorly designed system.

### AIR HANDLER EXTERNAL STATIC

To determine proper air movement, proceed as follows:

1. Using a draft gauge (inclined manometer), measure the static pressure of the return duct at the inlet of the unit, (Negative Pressure).
2. Measure the static pressure of the supply duct, (Positive Pressure).
3. Add the two (2) readings together for total absolute value of external static pressure (for example,  $-0.30'' \text{ wc} + 0.20'' \text{ wc} = 0.50'' \text{ wc}$  total static pressure).

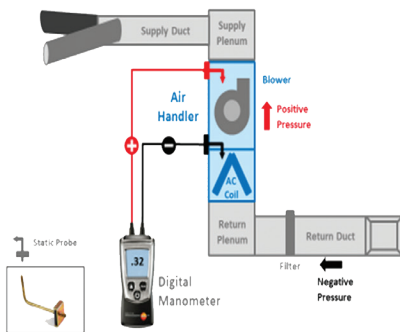

### CHECKING STATIC PRESSURE ON TWO PIECE AIR HANDLER

- Measure the static pressure of the supply duct at the outlet of the unit
- Measure the static pressure between the outlet of the evaporator coil and the inlet of the air handler
- Since the evaporator coil is not part of the blower unit or furnace, *it must be not considered in calculating the static pressure of the blower unit or furnace*
- **NOTE:** Both readings may be taken simultaneously if so desired

**NOTE:** Both readings may be taken simultaneously and read directly on the manometer if so desired.

4. Consult proper table for quantity of air.

If external static pressure is being measured on a furnace to determine airflow, supply static must be taken between the “A” coil and the furnace.

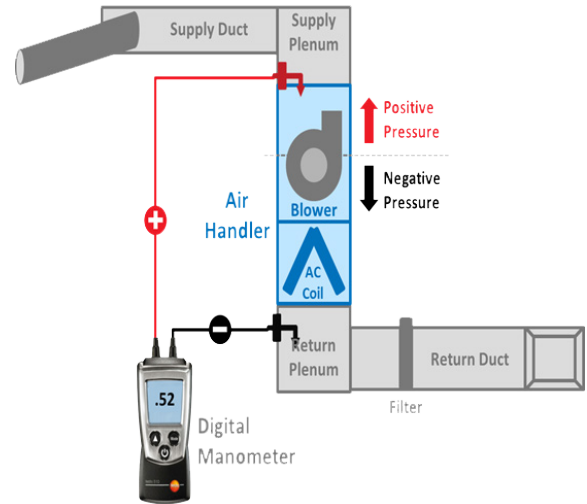

### CHECKING STATIC PRESSURE SINGLE PIECE AIR HANDLER

- Measure the static pressure of the supply duct at the outlet of the air handler
- Measure the static pressure of the return duct at the inlet of the air handler
- Single piece air handler evaporator coil is already considered in airflow calculation
- **NOTE:** Both readings may be taken simultaneously and read if so desired

### COIL STATIC PRESSURE DROP

1. Using a draft gauge (inclined manometer), connect the positive probe underneath the coil and the negative probe above the coil.
2. A direct reading can be taken of the static pressure drop across the coil.
3. Consult proper table for quantity of air.

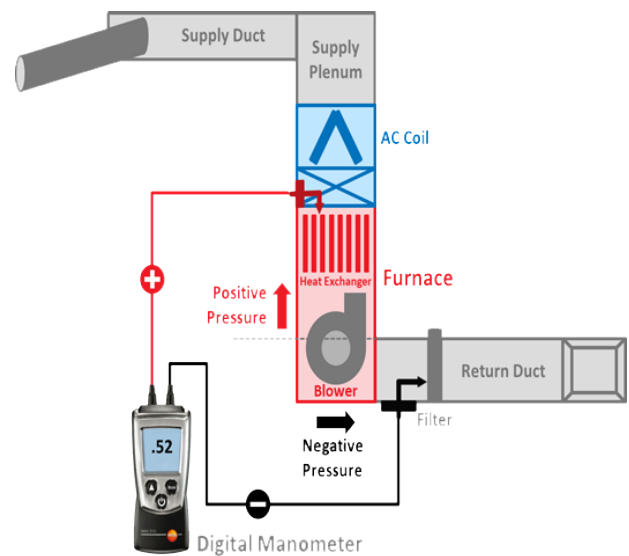

### CHECKING STATIC PRESSURE FURNACE

# SERVICING

- Measure static pressure of the return duct at the inlet of the furnace
- Measure the static pressure of the supply duct at the outlet of the furnace
- **NOTE:** Both readings may be taken simultaneously and read if so desired

If the total external static pressure and/or static pressure drop exceeds the maximum or minimum allowable statics, check for closed dampers, dirty filters, undersized or poorly laid out duct work.

## AIRFLOW CONSIDERATION

Airflow demands are managed differently in a fully communicating system than in a non-communicating wired system. The system operating mode (as determined by the thermostat) determines which unit calculates the system airflow demand. If the indoor unit is responsible for determining the airflow demand, it calculates the demand and sends it to the ECM motor. If the outdoor unit or thermostat is responsible for determining the demand, it calculates the demand and transmits the demand along with a fan request to the indoor unit. The indoor unit then sends the demand to the ECM motor. The table below lists the various communication systems, the operating mode, and airflow demand source.

For example, assume the system is an outdoor unit matched with an indoor unit. With a call for cooling, the outdoor unit will calculate the system's cooling airflow demand. The outdoor unit will then send a fan request along with the cooling airflow demand to the indoor unit. Once received, the indoor unit will send the cooling airflow demand to the ECM motor. The ECM motor then delivers the cooling airflow.

In continuous fan mode, the communicating thermostat provides the airflow demand. The communicating thermostat provides 4 continuous fan speeds (25%, 50%, 75% and 100% of maximum airflow). During continuous fan operation, the thermostat sends a fan request along with the continuous fan demand to the indoor unit. The indoor unit, in turn, sends the demand to the ECM motor. The ECM motor delivers the requested continuous fan airflow.

System	System Operating Mode	Airflow Demand Source
Any	Cooling	Outdoor Unit
	Heat Pump Heating Only	Outdoor Unit
	Continuous Fan	Thermostat
Air Handler or Modular blower	HP + Electric Heat Strips	Either outdoor unit or indoor unit, which has higher Airflow demand
	Electric Heat Strips Only	Indoor Unit
Gas Furnace	Combustion Heat	Indoor Unit

# SERVICING

## INDOOR UNIT TROUBLESHOOTING FOR TXV APPLICABLE UNIT (MBVC\*\*00AA-1)

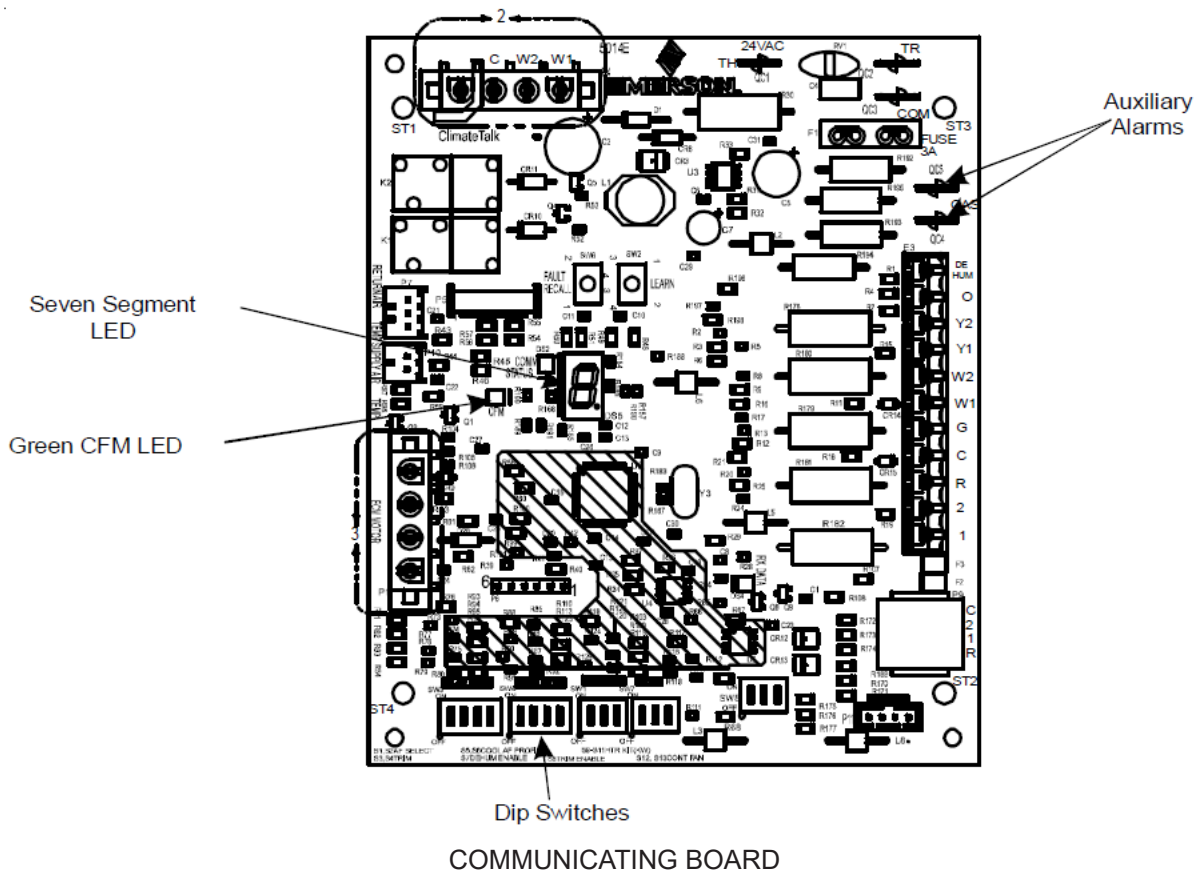

### AUXILIARY ALARM SWITCH

The control is equipped with two Auxiliary Alarm terminals, labeled CAS, which are typically utilized in series with a condensate switch but could also be used with compatible CO<sub>2</sub> sensors or fire alarms.

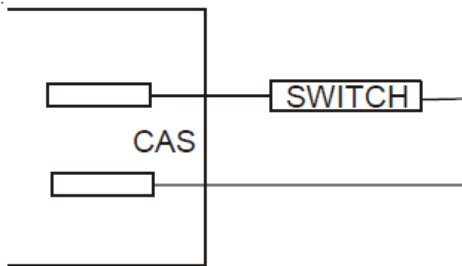

This feature can be activated or deactivated through the thermostat user menus. The auxiliary alarm switch must be normally closed and open when the alarm occurs. For example, a normally closed condensate switch will open when the base pan's water level reaches a particular level. The control will respond by turning off the blower motor and outdoor unit and displaying the proper fault codes. If the switch is later detected closed for 30 seconds, normal operation resumes and the error message is removed. The error will be maintained in the equipment's fault history. See FIGURE 15 on the following page for the connection location.

### CIRCULATOR BLOWER

This air handler is equipped with a variable speed circulator blower. This blower provides several automatically-adjusted blower speeds. The Specification Sheet applicable to your model provides an airflow table, showing the relationship between airflow (CFM) and external static pressure (E.S.P.). The electric heat dip switch default position is set to the OFF, OFF, OFF position and should be adjusted by the installer to match the installation requirements for the correct electric heating CFM.

Using the Electric Heat Airflow table below, set dip switches 9, 10, and 11 for the installed heater kit. Verify selected CFM by counting the green CFM LED blinks. The green CFM LED blinks once for each 100 CFM of airflow. If an electric heater kit has not been installed, set dip switches 9, 10, and 11 to any appropriate heater kit setting (see next page table for valid settings).

During the cooling operation, the outdoor unit will determine the indoor airflow.

# SERVICING

## INDOOR UNIT TROUBLESHOOTING FOR TXV APPLICABLE UNIT (MBVC\*\*00AA-1)

* (Factory Setting)	19 kW or 20 kW	15 kW	10 kW	8 kW	6 kW	5 kW	3 kW
OFF ON S9 S10 S11	OFF ON S9 S10 S11	OFF ON S9 S10 S11	OFF ON S9 S10 S11	OFF ON S9 S10 S11	OFF ON S9 S10 S11	OFF ON S9 S10 S11	OFF ON S9 S10 S11
Electric Heating Air Flow (*indicates factory setting)							

**NOTE:** Upon start up in communicating mode the circuit board may display an “Ec” error. This is an indication that the dip switches on the control board need to be configured in accordance with the Electric Heating Airflow Table. Configuring the dip switches and resetting power to the unit will clear the error code.

### TROUBLESHOOTING

#### ELECTROSTATIC DISCHARGE (ESD) PRECAUTIONS

**NOTE:** Discharge body’s static electricity before touching unit. An electrostatic can adversely affect electrical components.

Use the following precautions during air handler installation and servicing to protect the integrated control module from damage. By putting the air handler, the control, and the person at the same electrostatic potential, these steps will help avoid exposing the integrated control module to electrostatic discharge. This procedure is applicable to both installed and uninstalled (ungrounded) blowers.

1. Disconnect all power to the blower. Do not touch the integrated control module or any wire connected to the control prior to discharging your body’s electrostatic charge to ground.
2. Firmly touch a clean, unpainted, metal surface of the air handler blower near the control. Any tools held in a person’s hand during grounding will be discharged.
3. Service integrated control module or connecting wiring following the discharge process in step 2. Use caution not to recharge your body with static electricity; (i.e., do not move or shuffle your feet, do not touch ungrounded objects, etc.). If you come in contact with an ungrounded object, repeat step 2 before touching control or wires.
4. Discharge your body to ground before removing a new control from its container. Follow steps 1 through 3 if installing the control on a blower. Return any old or new controls to their containers before touching any ungrounded object.

### DIAGNOSTIC CHART

WARNING

**HIGH VOLTAGE**  
**DISCONNECT ALL POWER BEFORE SERVICING OR INSTALLING THIS UNIT. MULTIPLE POWER SOURCES MAY BE PRESENT. FAILURE TO DO SO MAY CAUSE PROPERTY DAMAGE, PERSONAL INJURY OR DEATH.**



Refer to the Troubleshooting Chart at the end of this manual for assistance in determining the source of unit operational problems. The 7 segment LED display will provide any active fault codes. An arrow printed next to the display indicates proper orientation (arrow points to top of display). See following image.



7 Segment Diagnostic Display

### FAULT RECALL

The integrated control module is equipped with a momentary push-button switch that can be used to display the last six faults on the 7 segment LED display. The control must be in Standby Mode (no thermostat inputs) to use the feature. Depress the push-button for approximately two seconds. The LED display will then display the six most recent faults beginning with the most recent fault and decrementing to the least recent fault. The faults may be cleared by depressing the button for greater than five seconds.

**NOTE:** Consecutively repeated faults are displayed a maximum of three times. Example: A clogged return air filter causes the air handler’s motor to repeatedly enter a limiting condition. The control will only store this fault the first three consecutive times the fault occurs.

# SERVICING

## INDOOR UNIT TROUBLESHOOTING FOR TXV APPLICABLE UNIT (MBVC\*\*00AA-1)

7 SEGMENT LED (characters will alternate)	DESCRIPTION OF CONDITION
(no display)	INTERNAL CONTROL FAULT / NO POWER
On	STANDBY, WAITING FOR INPUTS
Ec	HEATER KIT TOO LARGE, TOO SMALL, OR NO MATCH
E5	FUSE OPEN
EF	AUXILIARY SWITCH OPEN
d0	DATA NOT ON NETWORK
d1	INVALID DATA ON NETWORK
d4	INVALID Bluetooth® SHARED DATA LOADER BTSDL01 DATA
b0	BLOWER MOTOR NOT RUNNING
b1	BLOWER MOTOR COMMUNICATION ERROR
b2	BLOWER MOTOR HP MISMATCH
b3	BLOWER MOTOR OPERATING IN POWER, TEMP. , OR SPEED LIMIT
b4	BLOWER MOTOR CURRENT TRIP OR LOST ROTOR
b5	BLOWER MOTOR ROTOR LOCKED
b6	OVER/UNDER VOLTAGE TRIP OR OVER TEMPERATURE TRIP
b7	INCOMPLETE PARAMETER SENT TO MOTOR
b9	LOW INDOOR AIRFLOW
C1	LOW STAGE COOL - LEGACY MODE ONLY
C2	HIGH STAGE COOL - LEGACY MODE ONLY
P1	LOW STAGE HEAT PUMP HEAT - LEGACY MODE ONLY
P2	HIGH STAGE HEAT PUMP HEAT - LEGACY MODE ONLY
h1	EMERGENCY HEAT LOW - COMMUNICATING MODE ONLY
h2	EMERGENCY HEAT HIGH - COMMUNICATING MODE ONLY
FC	FAN COOL - COMMUNICATING MODE ONLY
FH	FAN HEAT - COMMUNICATING MODE ONLY
F	FAN ONLY
H1	ELECTRIC HEAT LOW
H2	ELECTRIC HEAT HIGH
dF	DEFROST - COMMUNICATING MODE ONLY (Note: defrost is displayed as H1 in a legacy setup)
GREEN CFM LED-EACH FLASH REPRESENTS 10CFM (USE FOR AIRFLOW APPROXIMATION ONLY) - EXAMPLE: 8 FLASHES = 800CFM	



# SERVICING

# INDOOR UNIT ERROR CODES

## INDOOR UNIT TROUBLESHOOTING FOR TXV APPLICABLE UNIT (MBVC\*\*00AA-1)

7-Segment LED Codes <i>Characters Will Alternate</i>		ComfortNet™ Thermostat Only Message		Possible Causes		Corrective Actions		Notes & Cautions	
Symptoms of Abnormal Operation (Legacy & ComfortNet™ Thermostat)		Fault Description		None		None		None	
<ul style="list-style-type: none"> <li>LED display is ON continuously</li> <li>Electric heaters fail to energize on a call for W1 or Auxiliary/ Emergency heat</li> <li>Integrated control module LED display provides the indicated error code.</li> <li>ComfortNet™ thermostat "Call for Service" icon illuminated</li> <li>ComfortNet™ thermostat scrolls "Check Air Handler" message</li> </ul>	On EC	<ul style="list-style-type: none"> <li>Normal operation.</li> <li>Heater kit selected via dipswitches is too large for heater kit's specified in shared data set</li> </ul>	HTR TOO LARGE	None EC	<ul style="list-style-type: none"> <li>Normal operation.</li> <li>Heater kit selected via dipswitches is too large for heater kits in shared data set</li> </ul>	<ul style="list-style-type: none"> <li>None</li> <li>Verify electric heat dipswitch set</li> <li>Verify the installed electric heater is valid for the air handler/blower. Check nameplate or Specification Sheet applicable to your model* for allowable heater kit(s).</li> <li>Verify shared data set is correct for the specific model. Re-populate data using correct Bluetooth® Shared Data Loader BTSDL01 if required.</li> </ul>	<ul style="list-style-type: none"> <li>Normal operation</li> <li>Turn power OFF prior to repair.</li> <li>Use Bluetooth® Shared Data Loader BTSDL01 for the specific model.</li> <li>Insert Bluetooth® Shared Data Loader BTSDL01 BEFORE turning power ON. Bluetooth® Shared Data Loader BTSDL01 may be removed after data is loaded.</li> <li>Turn power off before removing Bluetooth® Shared Data Loader BTSDL01.</li> </ul>	<ul style="list-style-type: none"> <li>Use Bluetooth® Shared Data Loader BTSDL01 for the specific model.</li> <li>Insert Bluetooth® Shared Data Loader BTSDL01 BEFORE turning power ON. Bluetooth® Shared Data Loader BTSDL01 may be removed after data is loaded.</li> <li>Turn power off before removing Bluetooth® Shared Data Loader BTSDL01.</li> </ul>	
<ul style="list-style-type: none"> <li>Electric heat airflow is higher than expected on a call for W1 or Auxiliary/Emergency heat</li> <li>Integrated control module LED display provides the indicated error code.</li> </ul>	EC	<ul style="list-style-type: none"> <li>Heater kit selected via dipswitches is too small for heater kits specified in shared data set</li> </ul>	HTR TOO SMALL	EC	<ul style="list-style-type: none"> <li>Heater kit selected via dipswitches is too small for heater kits in shared data set</li> </ul>	<ul style="list-style-type: none"> <li>Verify electric heat dipswitch set</li> <li>Verify the installed electric heater is valid for the air handler/blower. Check nameplate or Specification Sheet applicable to your model* for allowable heater kit(s).</li> <li>Verify shared data set is correct for the specific model. Re-populate data using correct Bluetooth® Shared Data Loader BTSDL01 if required.</li> </ul>	<ul style="list-style-type: none"> <li>Turn power OFF prior to repair.</li> <li>Use Bluetooth® Shared Data Loader BTSDL01 for the specific model.</li> <li>Insert Bluetooth® Shared Data Loader BTSDL01 BEFORE turning power ON. Bluetooth® Shared Data Loader BTSDL01 may be removed after data is loaded.</li> <li>Turn power off before removing Bluetooth® Shared Data Loader BTSDL01.</li> </ul>	<ul style="list-style-type: none"> <li>Use Bluetooth® Shared Data Loader BTSDL01 for the specific model.</li> <li>Insert Bluetooth® Shared Data Loader BTSDL01 BEFORE turning power ON. Bluetooth® Shared Data Loader BTSDL01 may be removed after data is loaded.</li> <li>Turn power off before removing Bluetooth® Shared Data Loader BTSDL01.</li> </ul>	
<ul style="list-style-type: none"> <li>Electric heat airflow is higher than expected on a call for W1 or Auxiliary/ Emergency heat</li> <li>Integrated control module LED display provides the indicated error code.</li> </ul>	EC	<ul style="list-style-type: none"> <li>Heater kit selected via dipswitches does not match heater kits specified in shared data set</li> </ul>	NO HTR MATCH	EC	<ul style="list-style-type: none"> <li>Heater kit selected via dipswitches is doesn't match heater kits in shared data set</li> </ul>	<ul style="list-style-type: none"> <li>Verify electric heat dipswitch set</li> <li>Verify the installed electric heater is valid for the air handler/blower. Check nameplate or Specification Sheet applicable to your model* for allowable heater kit(s).</li> <li>Verify shared data set is correct for the specific model. Re-populate data using correct Bluetooth® Shared Data Loader BTSDL01 if required.</li> </ul>	<ul style="list-style-type: none"> <li>Turn power OFF prior to repair.</li> <li>Use Bluetooth® Shared Data Loader BTSDL01 for the specific model.</li> <li>Insert Bluetooth® Shared Data Loader BTSDL01 BEFORE turning power ON. Bluetooth® Shared Data Loader BTSDL01 may be removed after data is loaded.</li> <li>Turn power off before removing Bluetooth® Shared Data Loader BTSDL01.</li> </ul>	<ul style="list-style-type: none"> <li>Use Bluetooth® Shared Data Loader BTSDL01 for the specific model.</li> <li>Insert Bluetooth® Shared Data Loader BTSDL01 BEFORE turning power ON. Bluetooth® Shared Data Loader BTSDL01 may be removed after data is loaded.</li> <li>Turn power off before removing Bluetooth® Shared Data Loader BTSDL01.</li> </ul>	
<ul style="list-style-type: none"> <li>Integrated control module LED display error code.</li> <li>ComfortNet™ thermostat "Call for Service".</li> </ul>	EF	<ul style="list-style-type: none"> <li>Aux switch open</li> </ul>	Aux Alarm Fault	EF	<ul style="list-style-type: none"> <li>High water level in the evaporation coil.</li> </ul>	<ul style="list-style-type: none"> <li>Check overflow pan and service</li> </ul>	<ul style="list-style-type: none"> <li>Turn power OFF prior to service.</li> </ul>	<ul style="list-style-type: none"> <li>Turn power OFF prior to service.</li> </ul>	

## INDOOR UNIT TROUBLESHOOTING FOR TXV APPLICABLE UNIT (MBVC\*\*00AA-1)

Symptoms of Abnormal Operation (Legacy & ComfortNet™ Thermostat)	7-Segment LED Codes Characters Will Alternate	Fault Description	ComfortNet™ Thermostat Only Message	Possible Causes	Corrective Actions	Notes & Cautions
<ul style="list-style-type: none"> <li>Air handler blower fails to operate</li> <li>Integrated control module LED display provides no signal.</li> <li>ComfortNet™ thermostat "Call for Service" icon illuminated</li> <li>ComfortNet™ thermostat scrolls "Check Air Handler" message</li> </ul>	No Display	<ul style="list-style-type: none"> <li>No 208/230 volt power to air handler blower or no 24 volt power to integrated control module</li> <li>Blown fuse or circuit breaker</li> <li>Integrated control module has an internal fault.</li> </ul>	INTERNAL FAULT	<ul style="list-style-type: none"> <li>Manual disconnect switch OFF or 24 volt wire improperly connected or loose</li> <li>Blown fuse or circuit breaker</li> <li>Integrated control module has an internal fault</li> </ul>	<ul style="list-style-type: none"> <li>Assure 208/230 volt and 24 volt power to air handler blower and integrated control module.</li> <li>Check integrated control module fuse (3A). Replace if necessary.</li> <li>Check for possible shorts in 208/230 volt and 24 volt circuits. Repair as necessary.</li> <li>Replace bad integrated control module.</li> </ul>	<ul style="list-style-type: none"> <li>Turn power OFF prior to repair.</li> <li>Replace integrated control module fuse with 3A automotive fuse.</li> <li>Replace integrated control module with correct replacement part</li> <li>Read precautions in "Electrostatic Discharge" section of manual.</li> </ul>
<ul style="list-style-type: none"> <li>Air handler blower fails to operate.</li> <li>Integrated control module LED display provides indicated error code.</li> <li>ComfortNet™ thermostat "Call for Service" icon illuminated.</li> <li>ComfortNet™ thermostat scrolls "Check Air Handler" message.</li> </ul>	d0	Data not yet on network.	NO NET DATA	<ul style="list-style-type: none"> <li>Air handler blower does not contain any shared data.</li> </ul>	<ul style="list-style-type: none"> <li>Populate shared data set using Bluetooth® Shared Data Loader BTSDDL01.</li> </ul>	<ul style="list-style-type: none"> <li>Turn power OFF prior to repair</li> <li>Use Bluetooth® Shared Data Loader BTSDDL01 for the specific model.</li> <li>Insert Bluetooth® Shared Data Loader BTSDDL01 BEFORE turning power ON.</li> <li>Bluetooth® Shared Data Loader BTSDDL01 may be removed after data is loaded.</li> <li>Error code will be cleared once data is loaded.</li> <li>Turn power off before removing Bluetooth® Shared Data Loader BTSDDL01</li> </ul>
<ul style="list-style-type: none"> <li>Air handler blower fails to operate.</li> <li>Integrated control module LED display provides indicated error code.</li> <li>ComfortNet™ thermostat "Call for Service" icon illuminated.</li> <li>ComfortNet™ thermostat scrolls "Check Air Handler" message.</li> </ul>	d1	Invalid data on network.	INVALID DATA	<ul style="list-style-type: none"> <li>Air handler blower does not contain an appropriate shared data set.</li> </ul>	<ul style="list-style-type: none"> <li>Populate correct shared data set using Bluetooth® Shared Data Loader BTSDDL01.</li> </ul>	<ul style="list-style-type: none"> <li>Turn power OFF prior to repair</li> <li>Use Bluetooth® Shared Data Loader BTSDDL01 for the specific model.</li> <li>Insert Bluetooth® Shared Data Loader BTSDDL01 BEFORE turning power ON.</li> <li>Bluetooth® Shared Data Loader BTSDDL01 may be removed after data is loaded.</li> <li>Error code will be cleared once data is loaded.</li> </ul>
<ul style="list-style-type: none"> <li>Operation different than expected or no operation.</li> <li>Integrated control module LED display provides indicated error code.</li> <li>ComfortNet™ thermostat "Call for Service" icon illuminated.</li> <li>ComfortNet™ thermostat scrolls "Check Air Handler" message.</li> </ul>	d4	Invalid Bluetooth® Shared Data Loader BTSDDL01 data.	INVALID MC DATA	<ul style="list-style-type: none"> <li>Shared data set on Bluetooth® Shared Data Loader BTSDDL01 has been rejected by integrated control module</li> </ul>	<ul style="list-style-type: none"> <li>Verify shared data set is correct for the specific model. Re-populate data using correct Bluetooth® Shared Data Loader BTSDDL01 if required.</li> </ul>	<ul style="list-style-type: none"> <li>Turn power OFF prior to repair</li> <li>Use Bluetooth® Shared Data Loader BTSDDL01 for the specific model.</li> <li>Insert Bluetooth® Shared Data Loader BTSDDL01 BEFORE turning power ON.</li> <li>Bluetooth® Shared Data Loader BTSDDL01 may be removed after data is loaded.</li> <li>Error code will be cleared once data is loaded.</li> <li>Turn power off before removing Bluetooth® Shared Data Loader BTSDDL01</li> </ul>

## INDOOR UNIT TROUBLESHOOTING FOR TXV APPLICABLE UNIT (MBVC\*\*00AA-1)

Symptoms of Abnormal Operation (Legacy & ComfortNet™ Thermostat)	7-Segment LED Codes Characters Will Alternate	Fault Description	ComfortNet™ Thermostat Only Message Code	Possible Causes	Corrective Actions	Notes & Cautions
<ul style="list-style-type: none"> <li>Air handler blower fails to operate.</li> <li>Integrated control module LED display provides indicated error code.</li> <li>ComfortNet™ thermostat "Call for Service" icon illuminated.</li> <li>ComfortNet™ thermostat scrolls "Check Air Handler" message.</li> </ul>	b0	<ul style="list-style-type: none"> <li>Circulator blower motor is not running when it should be running.</li> </ul>	<p>MOTOR NOT RUN</p>	<ul style="list-style-type: none"> <li>Loose wiring connection at circulator motor power leads or circulator motor power leads disconnected.</li> <li>Failed circulator blower motor.</li> </ul>	<ul style="list-style-type: none"> <li>Tighten or correct wiring connection.</li> <li>Check circulator blower motor. Replace if necessary.</li> </ul>	<ul style="list-style-type: none"> <li>Turn power OFF prior to repair.</li> <li>Replace circulator motor with correct replacement part.</li> </ul>
<ul style="list-style-type: none"> <li>Air handler blower fails to operate.</li> <li>Integrated control module LED display provides indicated error code.</li> <li>ComfortNet™ thermostat "Call for Service" icon illuminated.</li> <li>ComfortNet™ thermostat scrolls "Check Air Handler" message.</li> </ul>	b1	<ul style="list-style-type: none"> <li>Integrated control module has lost communications with circulator blower motor.</li> </ul>	<p>MOTOR COMM</p>	<ul style="list-style-type: none"> <li>Loose wiring connection at circulator motor control leads.</li> <li>Failed circulator blower motor.</li> <li>Failed integrated control module.</li> </ul>	<ul style="list-style-type: none"> <li>Tighten or correct wiring connection.</li> <li>Check circulator blower motor. Replace if necessary.</li> <li>Check integrated control module. Replace if necessary.</li> </ul>	<ul style="list-style-type: none"> <li>Turn power OFF prior to repair.</li> <li>Replace circulator motor with correct replacement part.</li> <li>Replace integrated control module with correct replacement part.</li> </ul>
<ul style="list-style-type: none"> <li>Air handler blower fails to operate.</li> <li>Integrated control module LED display provides indicated error code.</li> <li>ComfortNet™ thermostat "Call for Service" icon illuminated.</li> <li>ComfortNet™ thermostat scrolls "Check Air Handler" message.</li> </ul>	b2	<ul style="list-style-type: none"> <li>Circulator blower motor horse power in shared data set does not match circulator blower motor horse power.</li> </ul>	<p>MOTOR MISMATCH</p>	<ul style="list-style-type: none"> <li>Incorrect circulator blower motor in air handler blower.</li> <li>Incorrect shared data set in integrated control module.</li> </ul>	<ul style="list-style-type: none"> <li>Verify circulator blower motor horse power is the same specified for the specific air handler blower model. Replace if necessary.</li> <li>Verify shared data set is correct for the specific model. Re-populate data using correct Bluetooth® Shared Data Loader BTSDDL01 if required.</li> </ul>	<ul style="list-style-type: none"> <li>Turn power OFF prior to repair.</li> <li>Replace motor with correct replacement part.</li> <li>Use Bluetooth® Shared Data Loader BTSDDL01 for the specific model.</li> <li>Insert Bluetooth® Shared Data Loader BTSDDL01 BEFORE turning power ON. Bluetooth® Shared Data Loader BTSDDL01 may be removed after data is loaded.</li> <li>Error code will be cleared once shared data and motor horse power match.</li> <li>Turn power off before removing Bluetooth® Shared Data Loader BTSDDL01.</li> </ul>
<ul style="list-style-type: none"> <li>Air handler blower operates at reduced performance.</li> <li>Airflow delivered is less than expected.</li> <li>Integrated control module LED display provides b3 error code.</li> </ul>	b3	<ul style="list-style-type: none"> <li>Circulator blower motor is operating in a power, temperature, or speed limiting condition.</li> </ul>	<p>MOTOR LIMITS</p>	<ul style="list-style-type: none"> <li>Blocked filters.</li> <li>Restrictive ductwork.</li> <li>Undersized ductwork.</li> <li>High ambient temperatures.</li> </ul>	<ul style="list-style-type: none"> <li>Check filters for blockage. Clean filters or remove obstruction.</li> <li>Check ductwork for blockage. Remove obstruction. Verify all registers are fully open.</li> <li>Verify ductwork is appropriately sized for system. Resize/replace ductwork if necessary.</li> <li>See "Installation Instructions" for installation requirements.</li> </ul>	<ul style="list-style-type: none"> <li>Turn power OFF prior to repair.</li> </ul>
<ul style="list-style-type: none"> <li>Air handler blower fails to operate.</li> <li>Integrated control module LED display provides indicated error code.</li> <li>ComfortNet™ thermostat "Call for Service" icon illuminated.</li> <li>ComfortNet™ thermostat scrolls "Check Air Handler" message.</li> </ul>	b4	<ul style="list-style-type: none"> <li>Circulator blower motor senses a loss rotor control.</li> <li>Circulator blower motor senses high current.</li> </ul>	<p>MOTOR TRIPS</p>	<ul style="list-style-type: none"> <li>Abnormal motor loading, sudden change in speed or torque, sudden blockage of air handler blower/coil air inlet or outlet.</li> <li>High loading conditions, blocked filters, very restrictive ductwork, blockage of air</li> </ul>	<ul style="list-style-type: none"> <li>Check filters, filter grills/registers, duct system, and air handler blower/coil air inlet/outlet for blockages.</li> </ul>	<ul style="list-style-type: none"> <li>Turn power OFF prior to repair.</li> </ul>

## INDOOR UNIT TROUBLESHOOTING FOR TXV APPLICABLE UNIT (MBVC\*\*00AA-1)

Symptoms of Abnormal Operation (Legacy & ComfortNet™ Thermostat)		7-Segment LED Codes Characters Will Alternate		ComfortNet™ Thermostat Only Message Code		Possible Causes	Corrective Actions	Notes & Cautions
<ul style="list-style-type: none"> <li>Air handler blower fails to operate.</li> <li>Integrated control module LED display provides indicated error code.</li> <li>ComfortNet™ thermostat "Call for Service" icon illuminated.</li> <li>ComfortNet™ thermostat scrolls "Check Air Handler" message.</li> </ul>	b5	MTR LCKD ROTOR	<ul style="list-style-type: none"> <li>Circulator blower motor fails to start 10 consecutive times.</li> </ul>	b5	<ul style="list-style-type: none"> <li>Obstruction in circulator blower housing.</li> <li>Seized circulator blower motor bearings.</li> <li>Failed circulator blower motor.</li> </ul>	<ul style="list-style-type: none"> <li>Check circulator blower for obstructions. Remove and repair/replace wheel/motor if necessary.</li> <li>Check circulator blower motor shaft rotation and motor. Replace motor if necessary.</li> </ul>	<ul style="list-style-type: none"> <li>Turn power OFF prior to repair.</li> <li>Replace motor with correct replacement part.</li> <li>Replace wheel with correct replacement part.</li> </ul>	
<ul style="list-style-type: none"> <li>Air handler blower fails to operate.</li> <li>Integrated control module LED display provides indicated error code.</li> <li>ComfortNet™ thermostat "Call for Service" icon illuminated.</li> <li>ComfortNet™ thermostat scrolls "Check Air Handler" message.</li> </ul>	b6	MOTOR VOLTS	<ul style="list-style-type: none"> <li>Circulator blower motor shuts down for over or under voltage condition.</li> <li>Circulator blower motor shuts down due to over temperature condition on power module.</li> </ul>	b6	<ul style="list-style-type: none"> <li>High AC line voltage to air handler blower.</li> <li>Low AC line voltage to air handler blower.</li> <li>High ambient temperatures.</li> </ul>	<ul style="list-style-type: none"> <li>Check power to air handler blower. Verify line voltage to blower is within the range specified on the air handler blower rating plate.</li> <li>See "Installation Instructions" for installation requirements.</li> </ul>	<ul style="list-style-type: none"> <li>Turn power OFF prior to repair.</li> </ul>	
<ul style="list-style-type: none"> <li>Air handler blower fails to operate.</li> <li>Integrated control module LED display provides indicated error code.</li> <li>ComfortNet™ thermostat "Call for Service" icon illuminated.</li> <li>ComfortNet™ thermostat scrolls "Check Air Handler" message.</li> </ul>	b7	MOTOR PARAMS	<ul style="list-style-type: none"> <li>Circulator blower motor does not have enough information to operate properly. Motor fails to start 40 consecutive times.</li> </ul>	b7	<ul style="list-style-type: none"> <li>Error with integrated control module.</li> <li>Motor has a locked rotor condition.</li> </ul>	<ul style="list-style-type: none"> <li>Check integrated control module. Verify control is populated with correct shared data set. See data errors above for details.</li> <li>Check for locked rotor condition (see error code above for details).</li> </ul>	<ul style="list-style-type: none"> <li>Turn power OFF prior to repair.</li> <li>Replace with correct replacement part(s).</li> <li>Use Bluetooth® Shared Data Loader BTSDL01 for the specific model.</li> <li>Insert Bluetooth® Shared Data Loader BTSDL01 BEFORE turning power ON.</li> <li>Bluetooth® Shared Data Loader BTSDL01 may be removed after data is loaded.</li> <li>Turn power off before removing Bluetooth® Shared Data Loader BTSDL01.</li> </ul>	
<ul style="list-style-type: none"> <li>Air handler blower operates at reduced performance or operates on low stage when high stage is expected.</li> <li>Integrated control module LED display provides indicated error code.</li> </ul>	b9	LOW ID AIRFLOW	<ul style="list-style-type: none"> <li>Airflow is lower than demanded.</li> </ul>	b9	<ul style="list-style-type: none"> <li>Blocked filters.</li> <li>Restrictive ductwork.</li> <li>Undersized ductwork.</li> </ul>	<ul style="list-style-type: none"> <li>Check filters for blockage. Clean filters or remove obstruction.</li> <li>Check ductwork for blockage. Remove obstruction. Verify all registers are fully open.</li> <li>Verify ductwork is appropriately sized for system. Resize/replace ductwork if necessary.</li> </ul>	<ul style="list-style-type: none"> <li>Turn power OFF prior to repair.</li> </ul>	

# SERVICING

## TROUBLESHOOTING-INDOOR UNIT FOR EEV APPLICABLE UNIT



### WARNING

**HIGH VOLTAGE**  
**DISCONNECT ALL POWER BEFORE SERVICING OR**  
**INSTALLING THIS UNIT. MULTIPLE POWER SOURCES**  
**MAY BE PRESENT. FAILURE TO DO SO MAY CAUSE**  
**PROPERTY DAMAGE, PERSONAL INJURY OR DEATH.**



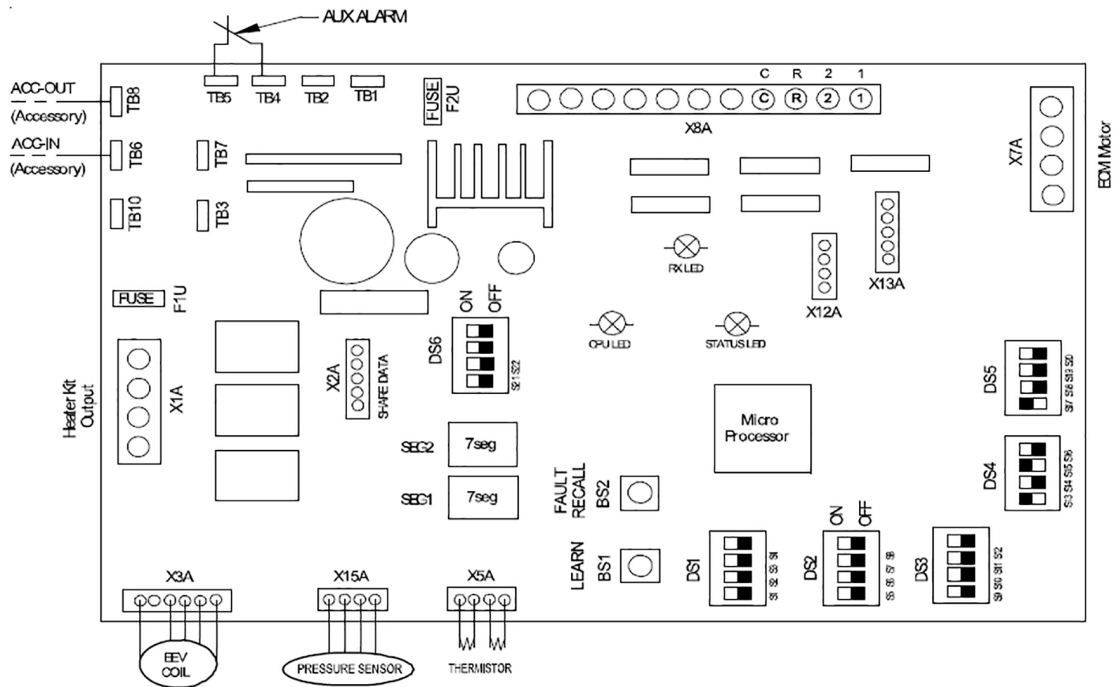

**INDOOR UNIT CONTROL BOARD**

### AUXILIARY ALARM SWITCH

The control is equipped with two Auxiliary Alarm terminals, labeled TB4 and TB5, which are typically utilized in series with a condensate switch but could also be used with compatible CO<sub>2</sub> sensors or fire alarms.

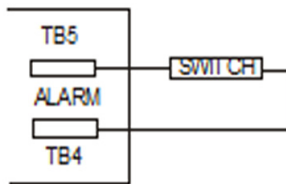

The auxiliary alarm switch must be normally closed and open when the alarm occurs. For example, a normally closed condensate switch will open when the base pan's water level reaches a particular level. The control will respond by turning off the blower motor and displaying the

proper fault codes. If the switch is later detected closed for 30 seconds, normal operation resumes and the error message is removed. The switch is closed as part of the default factory setting. The error will be maintained in the equipment's fault history.

### CIRCULATOR BLOWER

This air handler is equipped with a variable speed circulator blower. This blower provides several automatically-adjusted blower speeds. The Specification Sheet applicable to your model provides an airflow table, showing the relationship between airflow (CFM) and external static pressure (E.S.P.).

# SERVICING

## TROUBLESHOOTING-INDOOR UNIT FOR EEV APPLICABLE UNIT

**NOTE:** Upon start up in communicating mode the circuit board may display an “Ed” error. This is an indication that the dip switches on the control board need to be configured in accordance with the Electric Heating Airflow Table. Configuring the dip switches and resetting power to the unit will clear the error code.

## TROUBLESHOOTING

### ELECTROSTATIC DISCHARGE (ESD) PRECAUTIONS

**NOTE:** Discharge body’s static electricity before touching unit. Electrostatics can adversely affect electrical components.

Use the following precautions during air handler installation and servicing to protect the integrated control module from damage. By putting the air handler, the control, and the person at the same electrostatic potential, these steps will help avoid exposing the integrated control module to electrostatic discharge. This procedure is applicable to both installed and uninstalled (ungrounded) blowers.

1. Disconnect all power to the blower. Do not touch the integrated control module or any wire connected to the control prior to discharging your body’s electrostatic charge to ground.
2. Firmly touch a clean, unpainted, metal surface of the air handler blower near the control. Any tools held in a person’s hand during grounding will be discharged.
3. Service integrated control module or connecting wiring following the discharge process in step 2. Use caution not to recharge your body with static electricity; (i.e., do not move or shuffle your feet, do not touch ungrounded objects, etc.). If you come in contact with an ungrounded object, repeat step 2 before touching control or wires.
4. Discharge your body to ground before removing a new control from its container. Follow steps 1 through 3 if installing the control on a blower. Return any old or new controls to their containers before touching any ungrounded object.

### DIAGNOSTIC CHART

 <b>WARNING</b>	
<b>HIGH VOLTAGE</b> TO AVOID PERSONAL INJURY OR DEATH DUE TO ELECTRICAL SHOCK, DISCONNECT ELECTRICAL POWER BEFORE PERFORMING ANY SERVICE OR MAINTENANCE.	

Refer to the Troubleshooting Chart at the end of this manual for assistance in determining the source of unit operational problems. The 7 segment LED display will provide any active fault codes. An arrow printed next to the display indicates proper orientation (arrow points to top of display).

See following image.

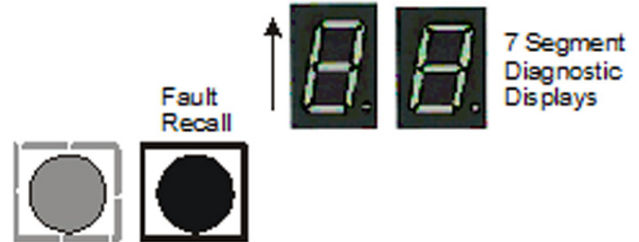

### FAULT RECALL

The integrated control module is equipped with a momentary push-button switch that can be used to display the last six faults on the 7 segment LED display. To display the faults, follow the steps below.

**NOTE:** The integrated control module must be in Standby Mode (no thermostat inputs).

1. Press FAULT RECALL button (for 2 to 5 seconds). The 7 segment LED display will blink “--”.

**NOTE:** If FAULT RECALL button is not pressed long enough (for 2 to 5 seconds, the control goes back to Standby Mode. If the button is pressed for 5 to 10 seconds, control goes back to Standby Mode.

2. Release the FAULT RECALL button. The 7 segment LED display will show the most recent fault.
3. Subsequent pressing of the FAULT RECALL button will recall a previous fault. At the end of the faults, the 7 segment LED display will show “--” and go back to Standby Mode.

**NOTE:** Consecutively repeated faults are displayed a maximum of three times. If the FAULT RECALL button is left untouched longer than 3 minutes, the control goes back to Standby Mode.

To clear the error code history:

1. Press FAULT RECALL button until the 7 segment LED display blinks “--”.
2. Release the FAULT RECALL button. The 7 segment LED display will show “88” and clear the faults.

**NOTE:** If FAULT RECALL button is help pressed for longer than 15 seconds, control goes back to Standby Mode.

## DIAGNOSTIC CODES

7 SEGMENT LED DISPLAY	DESCRIPTION OF CONDITION
On	Normal Operation
Eb	NO HTR KIT INSTALLED - SYSTEM CALLING FOR AUXILIARY HEAT (Minor Error Code)
Ed	HEATER KIT DIP SWITCHES NOT SET PROPERLY
E5	FUSE OPEN
EF	AUXILIARY SWITCH OPEN
d0	DATA NOT ON NETWORK
d1	INVALID DATA ON NETWORK
d4	INVALID Bluetooth™ SHARED DATA LOADER DATA
b0	BLOWER MOTOR NOT RUNNING
b1	BLOWER MOTOR COMMUNICATION ERROR
b2	BLOWER MOTOR HP (Horse power) MISMATCH
b3	BLOWER MOTOR OPERATING IN POWER, TEMP., OR SPEED LIMIT
b4	BLOWER MOTOR CURRENT TRIP OR LOST ROTOR
b6	OVER/UNDER VOLTAGE TRIP OR OVER TEMPERATURE TRIP
b7	INCOMPLETE PARAMETER SENT TO MOTOR
b9	LOW INDOOR AIRFLOW (Minor Error Code) (without EH mode)
9b	LOW INDOOR AIRFLOW (Major Error Code) (EH mode only)
70	EEV DISCONNECTION DETECTED
73	LIQUID SIDE THERMISTOR ABNORMALITY
74	GAS SIDE THERMISTOR ABNORMALITY
75	PRESSURE SENSOR ABNORMALITY
77	INDOOR UNIT - THERMOSTAT COMMUNICATION ERROR (STARTUP OPERATION & DURING OPERATION)
Hu	HUMIDIFICATION DEMAND (Running without heating)
FC	FAN COOL - COMMUNICATING MODE ONLY (Fan Demand-Cool)
FH	FAN HEAT - COMMUNICATING MODE ONLY (Fan Demand-Heat)
F	FAN ONLY (Fan Demand-Manual)
H1	ELECTRIC HEAT LOW (Heat Demand, Back-up Heat Demand)
H2	ELECTRIC HEAT HIGH (Heat Demand, Back-up Heat Demand)
dF	DEFROST - COMMUNICATING MODE ONLY (note: defrost is displayed as H1 in a legacy setup)

# SERVICING

## TROUBLESHOOTING-INDOOR UNIT FOR EEV APPLICABLE UNIT

### 2-digit 7 segment displays

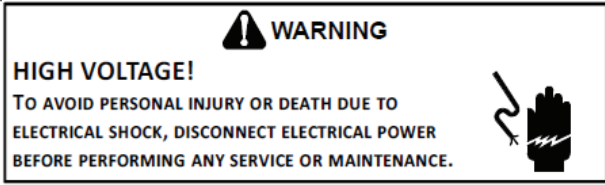

When the indoor unit is energized power supply, 2-digit 7 segment displays on indoor control board show current status of state, error code and airflow.

1. State shows current operation status of indoor unit described in right table.

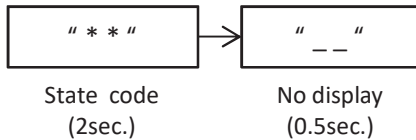

7 Segment LED Display (State)	Description of Condition
(No Display)	INTERNAL CONTROL FAULT/NO POWER
On	STANDBY, WAITING FOR INPUTS
FC	FAN COOL-COMMUNICATING MODE ONLY (Aux Heat Demand)
FH	FAN HEAT-COMMUNICATING MODE ONLY (Aux Heat Demand)
_F	FAN ONLY (Fan Demand-Manual)
H1	ELECTRIC HEAT LOW (Heat Demand, Back-up Heat Demand)
H2	ELECTRIC HEAT HIGH (Heat Demand, Back-up Heat Demand)
dF	DEFROST COMMUNICATING MODE ONLY
Hu	HUMIDITY RUNNING WITHOUT HEATING (Humidification Demand)

2. Error code shows current error indoor units have. To see the previous error code, please follow the instruction of fault recall. For more information of error code, please see the table of indoor unit error code.

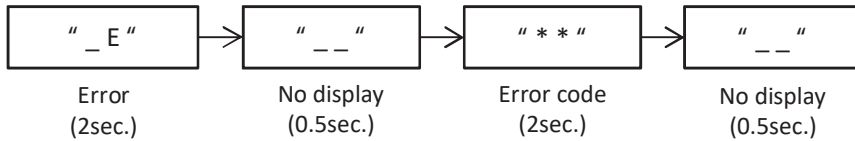

3. Airflow shows estimated CFM of indoor unit. For example, if the CFM is 1240CFM, 7 segment display shows "A...12...40...".

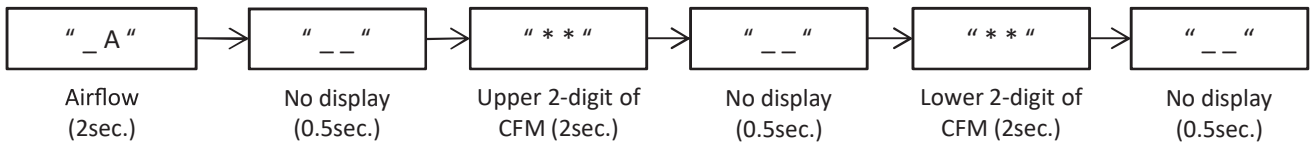

The contents indicated at 7 segment display vary from operation mode and status of indoor unit. In the event of showing some error code, please follow the instruction in the table of indoor unit error code to solve the error.

1. When the unit is running in normal mode, 2-digit 7 segment displays show state and airflow status.

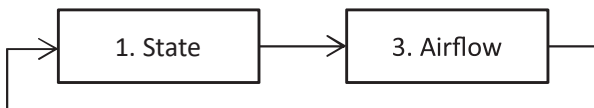

2. When the unit is having some major error code in normal mode, 2-digit 7 segment displays keep showing error code.

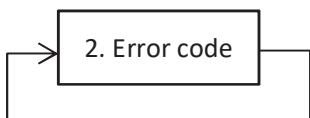



# SERVICING

## TROUBLESHOOTING-INDOOR UNIT FOR EEV APPLICABLE UNIT

### 2-digit 7 segment displays

3. When the unit is having some minor error code in normal mode, 2-digit 7 segment displays show error code and airflow status.

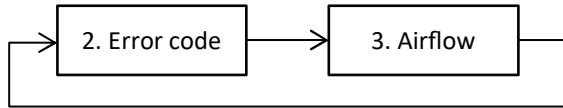

4. When the unit is having some minor error code during defrost operation in normal mode, 2-digit 7 segment displays show state "dF", error code and airflow status.

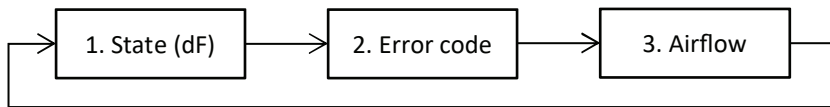

5. When the unit is having some minor error code in emergency mode, 2-digit 7 segment displays show state (EE) and error code.

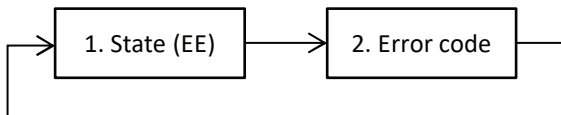

## MODE DISPLAY INTRODUCTION

A 2-digit display is provided on the Control Board as a backup tool to the thermostat for accessing error codes and erasing error code history of the indoor unit. Follow the information provided in this section to learn how to use the mode display.

## DISPLAY

The display consists of 2 digits.

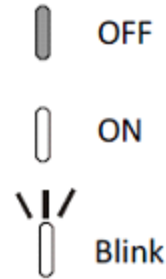

## DISPLAY BUTTON LAYOUT

The display buttons shown can be used to navigate and select items:

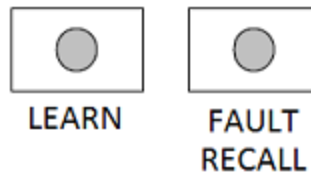

*Example of button layout is shown above*

## FAULT CODE HISTORY NAVIGATION

This mode will allow the user to see the six most recent system faults. Please follow the flow chart to navigate to error codes from screen zero.

For a list of the fault codes, please see the TROUBLESHOOTING tables in this document.

It is also possible to erase all the diagnostics codes from this menu.

# SERVICING

TROUBLESHOOTING-INDOOR UNIT FOR EEV APPLICABLE UNIT

# SETTING THE MODE DISPLAY

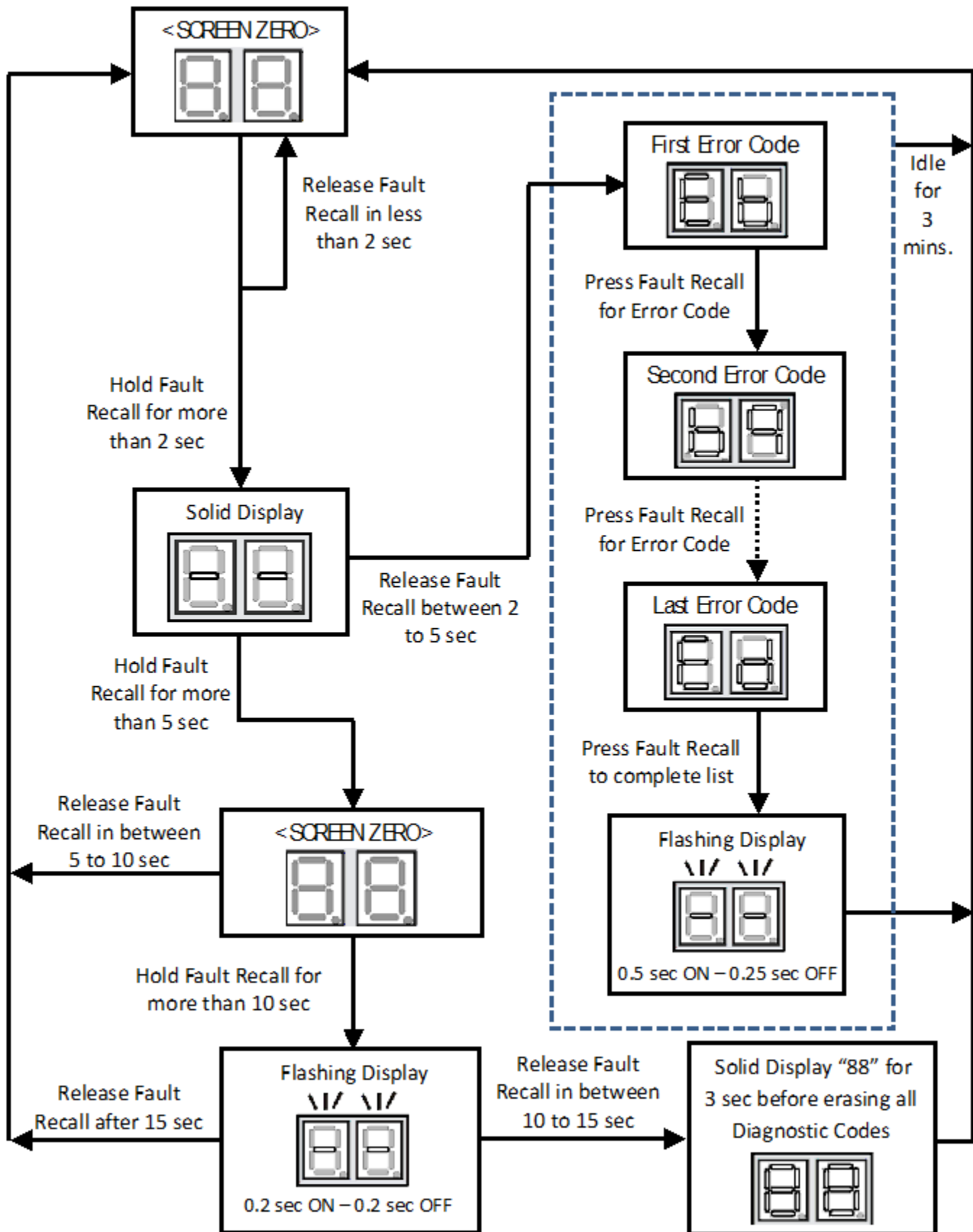

Error Code	Control Board LED Display	Transmitted Climate Talk Message *1	Description	Possible Causes	Corrective Actions
EE	No display (EE display is EMG mode)	INTERNAL FAULT	<ul style="list-style-type: none"> <li>No power supply to ID blower / no 24 volt power to control board</li> <li>Blown fuse or circuit breaker</li> <li>Control board has an internal fault</li> </ul>	<ul style="list-style-type: none"> <li>Manual disconnect switch OFF</li> <li>No power supply to ID blower / no 24 volt power to control board</li> <li>Blown fuse or faulty circuit breaker</li> <li>Control board has internal fault</li> </ul>	<ul style="list-style-type: none"> <li>Assure 208/230 volt and 24 volt power to blower and control board.</li> <li>Check fuse F2U on control board</li> <li>Check for possible short in 208/230 volt and 24 volt circuits. Repair as necessary.</li> <li>Replace the control board.</li> </ul>
Eb	E_Eb	No Display	Selecting "no heater kit" and receiving electric heat demand	<ul style="list-style-type: none"> <li>No heater kit selected</li> </ul>	<ul style="list-style-type: none"> <li>Select the valid heater kit on thermostat</li> <li>Valid dip switch selection (heater kit selection out of range of the unit configuration)</li> </ul>
Ed	E_Ed	Check Heater Kit Dip Switches (CHECK HTR DIPSW)	Heater Kit dip switches not set properly	<ul style="list-style-type: none"> <li>Invalid heater kit selected</li> </ul>	<ul style="list-style-type: none"> <li>Set correct dip switches</li> </ul>
E5	E_E5	BLOWN FUSE	Fuse Open	<ul style="list-style-type: none"> <li>Fuse (F1U) is blown</li> <li>Connector TB10 is open</li> </ul>	<ul style="list-style-type: none"> <li>Replace fuse</li> <li>Check wiring to AUX alarm, heater kit, communication connection.</li> </ul>
EF	E_EF	Auxiliary Contacts Open (AUX ALARM FAULT)	Auxiliary Switch Open	<ul style="list-style-type: none"> <li>High water level in the evaporation coil</li> <li>The connected alarm device is activated</li> <li>Auxiliary Alarm terminals (TB4, TB5) are open</li> </ul>	<ul style="list-style-type: none"> <li>Check water level in drain pan</li> <li>Check alarm device.</li> <li>Close Auxiliary terminals TB4 and TB5 if not used</li> </ul>
d0	E_d0	Data Not Yet On Network (NO NET DATA)	Data not on Network	<ul style="list-style-type: none"> <li>No shared data on the network</li> </ul>	<ul style="list-style-type: none"> <li>Populate shared data set using Bluetooth® Shared Data Loader BTSDL01.</li> </ul>
d1	E_d1	Invalid Data On Network (INVALID DATA)	Invalid Data on Network	<ul style="list-style-type: none"> <li>Wrong shared data on the network</li> </ul>	<ul style="list-style-type: none"> <li>Populate shared data set using Bluetooth® Shared Data Loader BTSDL01.</li> </ul>
d4	E_d4	Invalid Bluetooth® Shared Data Loader BTSDL01 data (INVALID MC DATA)	Invalid Bluetooth® Shared Data Loader BTSDL01 Data	<ul style="list-style-type: none"> <li>Wrong Bluetooth® Shared Data Loader BTSDL01 data</li> </ul>	<ul style="list-style-type: none"> <li>Replace circuit board</li> <li>Rewrite data using the correct Bluetooth® Shared Data Loader BTSDL01</li> </ul>
b0	E_b0	Blower Motor Not Running (MOTOR NOT RUN)	Blower Motor not running	<ul style="list-style-type: none"> <li>Fan/motor obstruction</li> <li>Power interruption (low voltage)</li> <li>Incorrect / loose wiring</li> </ul>	<ul style="list-style-type: none"> <li>Check for obstruction on the fan/motor</li> <li>Verify the input voltage at the motor</li> <li>Check wiring or tighten wiring connections if needed</li> <li>Replace circuit board or motor</li> </ul>
b1	E_b1	Blower Communication Error	Blower Motor Communication error	<ul style="list-style-type: none"> <li>Incorrect / loose wiring</li> <li>Power interruption (low voltage)</li> </ul>	<ul style="list-style-type: none"> <li>Check wiring or tighten wiring connections if needed</li> <li>Verify the input voltage at the motor</li> <li>Replace circuit board or motor</li> </ul>
b2	E_b2	Blower Motor HP Mismatch (MOTOR MISMATCH)	Blower Motor HP Mismatch	<ul style="list-style-type: none"> <li>Incorrect size motor</li> <li>Invalid shared data</li> </ul>	<ul style="list-style-type: none"> <li>Correct motor installation</li> <li>Populate shared data set using Bluetooth® Shared Data Loader BTSDL01.</li> </ul>
b3	E_b3	No Display	Blower Motor operating in Power, Temp or Speed Limiting conditions	<ul style="list-style-type: none"> <li>Fan/motor obstruction or blocked filters</li> <li>Power interruption (low voltage)</li> <li>Incorrect wiring</li> <li>Blockage in the airflow (ductwork) or ductwork</li> </ul>	<ul style="list-style-type: none"> <li>Check for obstruction on the fan/motor/ductwork, clean filters</li> <li>Verify the input voltage at the motor</li> <li>Check wiring</li> </ul>

Error Code	Control Board LED Display	Transmitted Climate Talk Message *1	Description	Possible Causes	Corrective Actions
b4	E_b4	Blower Trip or Lost Rotor (MOTOR TRIPS)	Blower Motor - Current Trip (or) Lost Rotor	<ul style="list-style-type: none"> <li>Fan/motor obstruction or abnormal motor loading</li> <li>Power interruption (low voltage)</li> <li>High loading conditions, blocked filters</li> <li>Blockage in the airflow (ductwork) or ductwork</li> </ul>	<ul style="list-style-type: none"> <li>Check for obstruction on the fan/motor/ductwork</li> <li>Verify the input voltage at the motor</li> <li>Check filters, grills, duct system, coil air inlet/outlet for blockages.</li> </ul>
b6	E_b6	Voltage or Temperature Trip (MOTOR VOLTS)	<ul style="list-style-type: none"> <li>Blower motor stops for over/under voltage</li> <li>Blower motor stops due to control board over heating</li> </ul>	<ul style="list-style-type: none"> <li>High AC line voltage to ID blower</li> <li>Low AC line voltage to ID blower</li> <li>High ambient temperatures</li> <li>Fan/motor obstruction or blockage in the airflow</li> </ul>	<ul style="list-style-type: none"> <li>Verify line voltage to blower is within the range specified on the ID blower rating plate</li> <li>See "Installation Instructions" for installation requirements</li> <li>Check power to air handler blower</li> <li>Check for obstruction on the fan/motor/ductwork</li> <li>Check wiring</li> <li>Replace motor</li> </ul>
b7	E_b7	Incomplete Parameters Send to Motor (MOTOR PARAMS)	ID blower motor does not have required parameters to function. Motor fails to start 40	<ul style="list-style-type: none"> <li>Wrong / no shared data on the network</li> <li>Locked motor rotor condition</li> </ul>	<ul style="list-style-type: none"> <li>Check for locked rotor condition (see above error code for details)</li> <li>Replace circuit board or motor</li> </ul>
b9	E_b9	No Display	Low Indoor Airflow (without Electric Heat mode)	<ul style="list-style-type: none"> <li>Fan/motor obstruction or blocked filters</li> <li>Restrictive ductwork or ductwork undersized</li> <li>ID motor failure</li> </ul>	<ul style="list-style-type: none"> <li>Check for obstruction on the fan/motor</li> <li>Check ductwork/filter for blockage, clean filters</li> <li>Remove obstruction. Verify all registers are fully open</li> <li>Check the connections and the rotation of the motor</li> <li>Verify the input voltage at the motor</li> <li>Verify ductwork is appropriately sized for system. Resize/replace ductwork if needed</li> <li>Replace motor</li> </ul>
9b	E_9b	LOW ID AIR EH MODE	Low Indoor Airflow (with Electric Heat mode)	<ul style="list-style-type: none"> <li>Fan/motor obstruction or blocked filters</li> <li>Restrictive ductwork or ductwork undersized</li> <li>ID motor failure</li> <li>Combination mistake of outdoor unit and indoor unit</li> </ul>	<ul style="list-style-type: none"> <li>Check for obstruction on the fan/motor</li> <li>Check ductwork/filter for blockage, clean filters</li> <li>Remove obstruction. Verify all registers are fully open</li> <li>Check the connections and the rotation of the motor</li> <li>Verify the input voltage at the motor</li> <li>Verify ductwork is appropriately sized for system. Resize/replace ductwork if needed</li> <li>Replace motor</li> </ul>
70	E_70	EEV OPEN CKT	EEV disconnection detected	<ul style="list-style-type: none"> <li>Indoor EEV coil not connected</li> <li>Incorrect wiring to EEV</li> </ul>	<ul style="list-style-type: none"> <li>Check indoor EEV coil connection (Control board and junction connector)</li> <li>Replace EEV coil</li> <li>Check the resistance value of EEV coil (refer service manual)</li> </ul>
73	E_73	LIQ TEMP FLT	Liquid side thermistor abnormality	<ul style="list-style-type: none"> <li>Open (or) short circuit of the liquid thermistor (X5A)</li> <li>Liquid thermistor reading incorrect or values outside the normal range</li> </ul>	<ul style="list-style-type: none"> <li>Check the connection to liquid thermistor (Control board and junction connector)</li> <li>Check the resistance value of the thermistor (refer service manual)</li> <li>Replace thermistor</li> </ul>
74	E_74	GAS TEMP FLT	Gas side thermistor abnormality	<ul style="list-style-type: none"> <li>Open (or) short circuit of the gas thermistor (X5A)</li> <li>Gas thermistor reading incorrect or values outside the normal range</li> </ul>	<ul style="list-style-type: none"> <li>Check the connection to gas thermistor (Control board and junction connector)</li> <li>Check the resistance value of the thermistor (refer service manual)</li> <li>Replace thermistor</li> </ul>
75	E_75	PRESSURE FLT	Pressure sensor abnormality	<ul style="list-style-type: none"> <li>Open (or) short circuit of the Pressure sensor (X15A)</li> <li>Pressure sensor reading incorrect or values outside the normal range</li> </ul>	<ul style="list-style-type: none"> <li>Check the connection to pressure sensor (Control board and junction connector)</li> <li>Check the output voltage of the pressure sensor (refer service manual)</li> <li>Replace pressure sensor</li> <li>Replace the control board</li> </ul>
77 <sup>2</sup>	E_77	No Display	Indoor Unit - Thermostat communication error (start-up & during operation)	<ul style="list-style-type: none"> <li>Incorrect wiring between ID unit and thermostat</li> <li>Thermostat failure</li> <li>Power interruption (low voltage)</li> </ul>	<ul style="list-style-type: none"> <li>Check for thermostat and indoor unit wiring</li> <li>Verify the input voltage at the ID unit and thermostat</li> <li>Replace control board or thermostat</li> <li>Press "LEARN" button on control board for more than 5 seconds to reestablish network</li> </ul>

(\*2) Network communication error (Refer to "NETWORK TROUBLESHOOTING")

# SERVICING

## AIR CONDITIONER ADVANCED FEATURE MENU

HEAT PUMP / FAULT CODE HISTORY		
SUBMENU ITEM	INDICATION/USER MODIFIABLE OPTIONS	COMMENTS
ALL	(The Active and History Fault codes are displayed.)	Active fault code and up to 6 fault code histories.
ACTIVE	(The Active Fault codes are displayed.)	Active fault code only.
HISTORY	(The History Fault codes are displayed.)	Up to 6 fault code histories.
REFRESH	N/A	Selecting this menu will refresh the display.

HEAT PUMP / CONFIGURATION INFO		
SUBMENU ITEM	INDICATION/USER MODIFIABLE OPTIONS	COMMENTS
HVAC DEVICE	HEAT PUMP	The type of HVAC Device.
FIRMWARE VERSION	**	Specific number associated with the control software.
MODEL NUMBER	*VZC200*01*	This number match the model name found on the serial plate.
SERIAL NUMBER	*****	This number match the serial number found on the serial plate.

HEAT PUMP / DEVICE STATUS		
SUBMENU ITEM	INDICATION(Units)	COMMENTS
HEAT CAPACITY REQUEST	%	The request for heating. 0% means the system is off. All other values mean the system is running.
COOL CAPACITY REQUEST	%	The request for cooling. 0% means the system is off. All other values mean the system is running.
HEAT CAPACITY REQUEST DURING DEFROST	%	Indoor heat request during defrost operation. It states that additional capacity is being requested or if it is not being requested. The outdoor unit will request supplemental heating while a defrost cycle is running. 0% means defrost is not being requested and additional heating is not requested and additional heating is not required. All other values mean defrost is being requested and additional heat is being requested.
DEHUMIDIFICATION REQUEST	%	Request for dehumidification. 0% means dehumidification is not being requested. All other values mean dehumidification is being requested.
OUTDOOR FAN SPEED	RPM	Current speed of the outdoor fan in rotations per minute.
REQUESTED AIRFLOW	CFM	This is the airflow the indoor unit will try to deliver while the unit is active.
REPORTED AIRFLOW	CFM	Indoor airflow (in cubic feet per minute) as reported by the indoor unit.
BOOST MODE	OFF or ON	If this feature is available and enabled, an inverter can ramp the compressor above default speeds to increase capacity. This shows if the feature is active or inactive. To check if this function is enabled, find the Boost Mode Enable item in the setting for this unit.

HEAT PUMP / SENSOR DATA		
SUBMENU ITEM	INDICATION(Units)	COMMENTS
OUTDOOR TEMP	F	Displays the outdoor air temperature.
COIL TEMP	F	Displays the outdoor coil temperature.
LIQUID LINE TEMP	F	Displays the outdoor liquid temperature.
DISCHARGE TEMP	F	Displays the outdoor discharge temperature.
DEFROST SENSOR	F	Displays the defrost temperature.
SUCTION PRESSURE	PSI	Displays the pressure of taken slightly upstream of the suction accumulator.

A representative menu is posted. Item names and setting value are subject to change.

# SERVICING

## AIR CONDITIONER ADVANCED FEATURE MENU

HEAT PUMP / DEVICE SETTING (1)		
SUBMENU ITEM	INDICATION(Units)	COMMENTS
BOOST MODE ENABLE	OFF or ON	BOOST MODE is ON by default. See BOOST MODE section of this manual for more details.
BOOST TEMP	Always Active or 70F to 105F in increments	If enabled, when the ambient outdoor temperature is greater than this selected value, boost mode will be operational. Below this temperature the mode will not function. There is also an option to keep boost mode continuously enabled.
INDOOR/OUTDOOR HEIGHT DIFFERENCE	Both Units at Same Level, Outdoor Unit is Lower, or Indoor Unit is Lower	If the outdoor & indoor units are within +/- 15 ft. vertical distance, select SAME LEVEL. If the outdoor unit is more than 15 ft. below the indoor unit, select OUTDOOR LOWER. If the outdoor unit is more than 15 ft. above the indoor unit, select INDOOR LOWER.
RESET FOR SYSTEM SET UP	NO or YES	Selecting yes will reset any system setting to their factory defaults.
SYSTEM VERIFICATION TEST	OFF or ON	System Verification Test must be run after installation. This is approximately a 5-15 minute test. If operation mode is set to COOL mode, the system will enter CHARGE mode upon completion, otherwise it will stop.
PUMP DOWN	OFF or ON	Enter PUMP DOWN Mode. This procedure runs the equipment for approximately 15 minutes and allows accumulation of refrigerant at the outdoor unit for purposes of removing & replacing the indoor unit or outdoor unit.
ACTIVATE CHARGE MODE	OFF or ON	Enter Charging Mode. This allows for a steady system operation for a duration of approximately 1 hour to allow for refrigerant charging of the system via the charge port.
COOLING TRIM FACTOR(HIGH) <sup>*1, 2</sup>	-15% to +15% in 5% increments	Select this airflow trim when inverter system is running high compressor speeds during a cooling cycle.
COOLING TRIM FACTOR(MID)	-15% to +15% in 5% increments, 20 30, Full(Max) <sup>*3</sup>	Select this airflow trim when inverter system is running mid-range (intermediate) compressor speeds during a cooling cycle.
COOLING TRIM FACTOR(LOW)	-15% to +15% in 5% increments, 20 30, Full(Max) <sup>*3</sup>	Select this airflow trim when inverter system is running low compressor speeds during a cooling cycle.
COOLING AIRFLOW PROFILE	A, B, C, or D	If it is desirable to quickly ramp up the indoor airflow select profile A. If it is desirable to reach nominal airflow quickly, but a slower ramp up time is required, select profile B. If dehumidification is required immediately when cooling mode begins select profile C. If a slower airflow ramp up / ramp down time is required in addition to dehumidification select profile D.
BLOWER ON DELAY-COOLING	5, 10, 20 or 30 Seconds	Delay between compressor turning on and indoor blower turning on during a cooling cycle.
BLOWER OFF DELAY-COOLING	30, 60, 90 or 120 Seconds	Delay between compressor shutting off and the indoor blower shutting off after a cooling cycle.

A representative menu is posted. Item names and setting value are subject to change.

\*1 At Cool and Heat Hi speed trim, \*SXV906010\*\* with \*\*VC960804C,

\*\*VM970804C and \*MVC800804C combination trim more than 5% settings are invalid. Trimmed up CFM makes miss matching error.

\*2 Other than the above, depending on the connected indoor unit, there are restrictions on the positive side Trim setting.

If you want to change the Cool Airflow Trim to positive side, be sure to confirm the Airflow Trim restrictions in the latest indoor unit installation manual. The latest manual can be obtained from the website "PartnerLink(InfoFinderPlus/Literature)".

[PartnerLink URL]

<https://partnerlinkmarketing.goodmanmfg.com/goodman/info-finder-plus>

\*3 The Inverter system uses lower compressor speed and lower indoor unit CFM to optimize system performance.

To obtain 100% CFM for home circulation, use full Trim setting instead of Int/Low speed.

This is recommended for applications with unusually cold return temperatures such as basements.

\*4 Please refer to the page of "DEHUMIDIFICATION SELECT" for details of this function.

# SERVICING

## AIR CONDITIONER ADVANCED FEATURE MENU

AIR CONDITIONER / DEVICE SETTING (2)		
SUBMENU ITEM	INDICATION(Units)	COMMENTS
DEHUMIDIFICATION ENABLE <sup>4</sup>	Standard, OFF, A, B or C	Selecting "OFF" disables dehumidification selecting. "Standard", "A", "B" or "C" enables dehumidification.
RESET COOLING SETTINGS	NO or YES	Selecting yes will reset any cooling setting to their factory defaults.
RPS RANGE FOR COOLING	**.* to *.* RPS,...(Total 5 Ranges)	When determining the appropriate compressor speed for cooling, select the range that contains the desired value. The Selected RPS for Cooling menu is where you will select your desired value within this selected range.
SELECTED RPS FOR COOLING	**.* RPS	This value will be a number inside the RPS Range for Cooling. If you'd like to select a RPS from a different range, you must change the RPS Range for Cooling setting first, then restart the device setting page.

A representative menu is posted. Item names and setting value are subject to change.

\*1 At Cool and Heat Hi speed trim, \*SXV906010\*\* with \*\*VC960804C,

\*\*VM970804C and \*MVC800804C combination trim more than 5% settings are invalid. Trimmed up CFM makes miss matching error.

\*2 Other than the above, depending on the connected indoor unit, there are restrictions on the positive side Trim setting.

If you want to change the Cool Airflow Trim to positive side, be sure to confirm the Airflow Trim restrictions in the latest indoor unit installation manual. The latest manual can be obtained from the website "PartnerLink(InfoFinderPlus/Literature)".

[PartnerLink URL]

<https://partnerlinkmarketing.goodmanmfg.com/goodman/info-finder-plus>

\*3 The Inverter system uses lower compressor speed and lower indoor unit CFM to optimize system performance.

To obtain 100% CFM for home circulation, use full Trim setting instead of Int/Low speed.

This is recommended for applications with unusually cold return temperatures such as basements.

\*4 Please refer to the page of "DEHUMIDIFICATION SELECT" for details of this function.



# SERVICING

## EMERGENCY MODE FOR EEV APPLICABLE INDOOR UNIT

 <b>WARNING</b>
<p><b>HIGH VOLTAGE</b>  <b>DISCONNECT ALL POWER BEFORE SERVICING.</b>  <b>MULTIPLE POWER SOURCES MAY BE PRESENT. FAILURE TO DO SO MAY CAUSE PROPERTY DAMAGE, PERSONAL INJURY OR DEATH.</b></p> 

Emergency mode is to only be used in a situation where communication between equipment (broken wires) or a failed thermostat cannot be immediately corrected or replaced. This mode will allow for cooling or heating to be activated without the need of communication wires or a thermostat. Once corrections have been made to wiring or the thermostat, emergency mode must be turned off and the system returned to normal operation (this applies to both the indoor and outdoor units). NOTE: Emergency mode does not control to a specific room temperature set point. Exact room temperature achieved is related to the building load at the time emergency mode is activated. This is only a temporary solution.

At first inspection, if the outdoor unit is displaying one of the following error codes: E51 (outdoor communication error), Eb0 (no indoor airflow), Eb9 (low indoor airflow), Ed2 (Indoor unit is too small and cannot provide airflow of outdoor unit) or the indoor unit is displaying error code E77 (no thermostat communications) it is acceptable to use emergency mode if the equipment cannot be immediately fixed. Cycling power to the equipment may temporarily clear error codes, but doing so may not fix the underlying problem. NOTE: If after initial power up communication issues occur due to faulty wires or a thermostat these error codes may not be displayed.

In emergency mode, the unit will function according to the mode selected on the appropriate dip switches. Operation in emergency mode must be limited to a minimum and should be viewed as a temporary solution before the issue with the unit is resolved and system operates in normal mode.

**NOTE:** In the emergency operation, the operating status will not be shown in the thermostat status menu or on the outdoor 7-segment displays. The 7-segment displays on indoor control board will display “EE”.

## 1. HEATING EMERGENCY MODE

Emergency Heating mode is to be used when communication between the indoor unit and thermostat is not functioning properly. This mode will run the electric heat strips independently of any thermostat in one of two modes: High Heat Level or Low Heat Level. Dip Switch Bank DS-6 (specifically dip switches S-21 and S-22) on the indoor control is used to engage emergency heating mode. Default setting for these two dip switches are in the OFF position (S21 set to ON and S22 set to ON will enable Low Heat Level Emergency Mode. S21 set to OFF and S22 set to ON will enable High Heat Level Emergency Mode). NOTE: once equipment has been fixed, these dip switches must be placed back in the OFF position. During operation, the indoor fan and electric heater kit will be turned on and off at following intervals based on the Heat Level selected. 2 stage electric heater kits will be energized in stage 2.

	Heating On	Heating Off
High Heat Level	8 minutes	8 minutes
Low Heat Level	7 minutes	15 minutes

Emergency Heat Mode Airflow: DIP switches S-9, S-10, S-11 and S-12 must be set to the correct size electric heat kit that has been installed. These are located on dip switch bank DS-3 of the indoor control. See the Switch Bank DS-3 Indoor Control Board Settings table to properly select heater kit size.

To activate heating emergency mode, appropriately select switches S-21 and S-22 from dip switch bank DS-6 on the indoor control board depending on the heat level required in accordance with the Switch Bank DS-6 Indoor Control Board Settings table.

**NOTE:** During the heating emergency mode, outdoor unit must stop operation. Once the communication is established, heating emergency mode must be terminated so that the system resumes operation in normal mode. To eliminate the heating emergency mode, dip switches S-21 and S-22 from dip switch bank DS-6 on the indoor control board must be set back to default factory settings (normal operating mode).

# SERVICING

Upon start up in emergency mode the circuit board may display an “Ed” error. This is an indication that the DIP switches on the control board need to be configured in accordance with the Electric Heating Airflow Table. Configuring the DIP switches to the unit will clear the error code.

Switch Bank DS-3 Indoor Control Board Settings								
Heater Kit Selection	Heater kW				Dip Switch Setting			
	AMVE24BP14	AMVE36CP14	AMVE48DP14	AMVE60DP14	S-9	S-10	S-11	S-12
No Heater	-	-	-	-	OFF*	OFF*	OFF*	OFF*
First	3	5	5	5	ON	ON	ON	ON
Second	5	6	6	6	ON	ON	ON	OFF
Third	6	8	8	8	ON	ON	OFF	ON
Fourth	8	10	10	10	ON	ON	OFF	OFF
Fifth	10	15	15	15	ON	OFF	ON	ON
Sixth	X	19	20	20	ON	OFF	ON	OFF
Seventh	X	X	X	25	ON	OFF	OFF	ON

Switch Bank DS-6 Indoor Control Board Settings				
Function			S-21	S-22
Normal operation			OFF*	OFF*
Emergency Mode	Cooling Emergency mode/Fan only Emergency mode		ON	OFF
	Heating Emergency mode (High heat level)		OFF	ON
	Heating Emergency mode (Low heat level)		ON	ON

Switch Bank DS-2 Outdoor Control Board Settings				
Function			S-1	S-2
Normal operation			ON*	ON*
Emergency Mode	Cooling Emergency mode (Low cool Level)		ON	OFF
	Cooling Emergency mode (Medium cool Level)		OFF	ON
	Cooling Emergency mode (High cool level)		OFF	OFF

NOTE: Default factory settings are marked with \*.

# SERVICING

## 2. COOLING EMERGENCY MODE

Cooling emergency mode is to be used when communication between the indoor and outdoor units is not functioning properly and temporary cooling operation is required. This mode enables the outdoor unit and indoor unit to run independently of each other. There are two key steps to setup Cooling Emergency Mode.

- Select the appropriate airflow on the indoor unit and enable emergency indoor airflow operation (using Dip switches S-13 and S-14 of Switch Bank DS-4 on the indoor unit to select desired 25%, 50%, 75% or 100% airflow. In addition, set switch bank DS-6 dip switches S-21 to ON and S-22 to OFF enabling emergency indoor fan).
- Select the desired cooling level at the outdoor unit (there are 3 levels available: Low Cool Level, Medium Cool Level, High Cool Level selectable by dip switch bank DS-2 on the outdoor unit). See Dip Switch Position DS2-1 and DS2-2 Table for cooling level selection.

	ON time	OFF time	Avg. Run Time
<b>Low Cool Level</b>	7 minutes	15 minutes	30%
<b>Medium Cool Level</b>	8 minutes	10 minutes	50%
<b>High Cool Level</b>	15 minutes	6 minutes	70%

**NOTE:** This mode does not require a thermostat. Any thermostat requests will be ignored while in emergency operation.

**NOTE:** Set indoor DS-4 (Indoor fan setting) and DS-6 (Indoor emergency mode enable) before setting outdoor DS-2 dip switch settings. Otherwise, the compressor may be damaged in operation.

**NOTE:** When proper communication is established, these switches must be returned to default settings

Switch Bank DS-4 Indoor Fan Settings					
Function	Value	SW13	SW14	SW15	SW16
Fan Only Speed %	25	OFF	OFF	-	-
	50	ON*	OFF*	-	-
	75	OFF	ON	ON*	-
	100	ON	ON	OFF	-

The compressor speed will automatically adjust based on the outdoor ambient temperature. If ambient temperature is higher than 95°F, the outdoor unit can operate at 100% compressor speed. If ambient temperature is lower than 70°F, the unit will run at 50% compressor speed. Between 95°F and 70°F, the compressor speed will adjust linearly as shown.

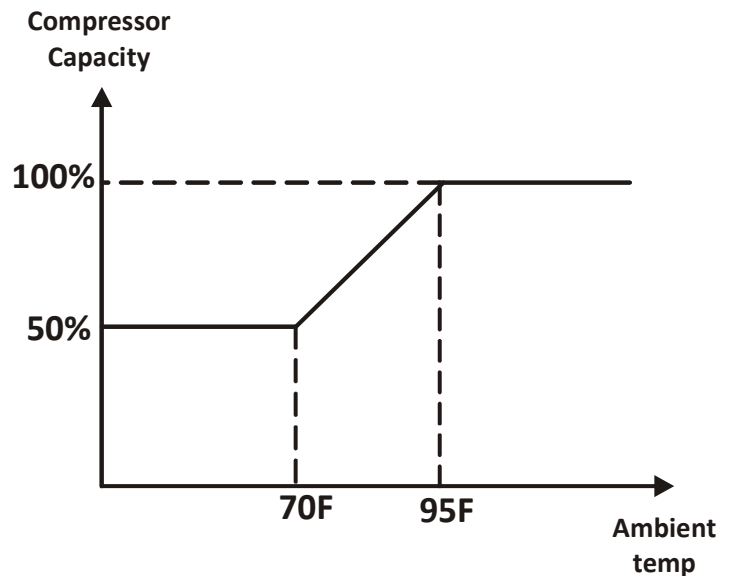

During operation the indoor unit will provide constant airflow as selected (even if the compressor has stopped). The indoor unit will continue to operate the electronic expansion valve for refrigerant super heat control and the compressor will cycle at the interval selected by dip switch bank DS-2.

Dip Switch Position		Function
DS2-1	DS2-2	
ON	ON	Normal Operation
ON	OFF	Emergency Mode (Low Cool Level)
OFF	ON	Emergency Mode (Medium Cool Level)
OFF	OFF	Emergency Mode (High Cool Level)

# SERVICING

TROUBLESHOOTING- OUTDOOR UNIT AND INDOOR UNIT FOR EEV APPLICABLE UNIT

<b>Dipswitch Default Factory Settings</b>			
<b>Switch #</b>		<b>Setting</b>	<b>Function</b>
<b>ID DS-1</b>	1	OFF	No Use
	2	OFF	No Use
	3	OFF	No Use
	4	OFF	No Use
<b>ID DS-2</b>	5	OFF	No Use
	6	OFF	No Use
	7	OFF	No Use
	8	OFF	No Use
<b>ID DS-3</b>	9	OFF	Heater Kit Selection in Emergency Mode
	10	OFF	Heater Kit Selection in Emergency Mode
	11	OFF	Heater Kit Selection in Emergency Mode
	12	OFF	Heater Kit Selection in Emergency Mode
<b>ID DS-4</b>	13	ON	Allow in Emergency Mode (Fan Emergency Mode)
	14	OFF	Allow in Emergency Mode (Fan Emergency Mode)
	15	ON	EEV Enable**
	16	OFF	No Use
<b>ID DS-5</b>	17	ON	Emergency EEV Opening
	18	OFF	Emergency EEV Opening
	19	OFF	EEV Emergency Mode**
	20	OFF	No Use
<b>ID DS-6</b>	21	OFF	Emergency mode (Cooling and Heating Emergency Mode)
	22	OFF	Emergency mode (Cooling and Heating Emergency Mode)
	23	OFF	No Use
	24	OFF	No Use
<b>OD DS-1</b>	1	ON	CT Communication Enable*
	2	ON	CT Communication Enable*
<b>OD DS-2</b>	1	OFF	Cooling Emergency mode*
	2	OFF	Cooling Emergency mode*

\* Must be set at factory setting to operate the normal mode.

\*\* Must be set at factory setting indoor unit with EEV. It's prohibited to change setting.

# SERVICING

## COOLING EMERGENCY MODE WIRING FOR TXV APPLICABLE INDOOR UNIT

Cooling emergency mode is available when using a TXV applicable indoor unit. To energize the blower at the appropriate speed, standard Legacy wiring is required. The image below shows how the thermostat input terminals are to be wired when selecting a cooling airflow. NOTE: the blower will run continuously with this wiring which is required. The outdoor unit will cycle as described in the Cooling Emergency Mode section when appropriate dip switch modes are set.

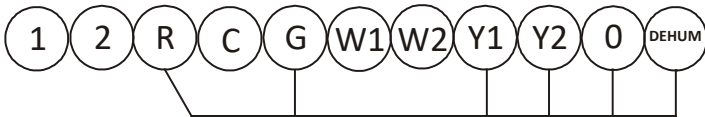

### INDOOR UNIT INTEGRATED CONTROL MODULE

**NOTE:** Emergency heating mode is not available with TXV applicable indoor units. If communications still exist between the indoor unit and thermostat, the thermostat should be used to provide heating calls.

**MODE DISPLAY INTRODUCTION**

A 3-digit display is provided on the Control board as a backup tool to the thermostat for reading faults, fault history, monitoring and setting up the unit. Follow the information provided in this section to learn how to use the mode display.

**DISPLAY**

The display consists of 3 digits.

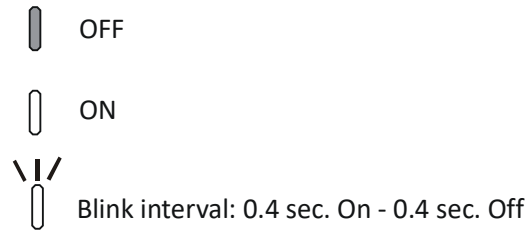
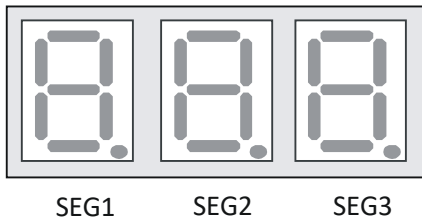

**DISPLAY BUTTON LAYOUT**

The display buttons shown can be used to navigate and select items:

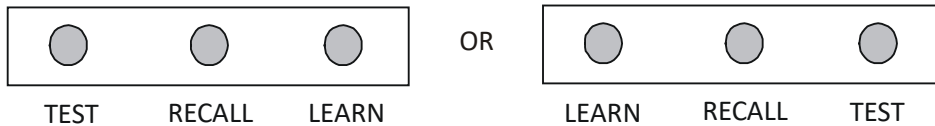

*Examples of button layout are shown above.  
 Identify correct display buttons on your unit Control board.*

**MODES**

There are 5 modes which can be accessed using the setting display: FAULT CODE, FAULT HISTORY, MONITORING, SETTING MODE 1 and SETTING MODE 2.

To enter any of these modes, use the schemes shown in this section. Each mode has its own corresponding "Screen #" within the display itself which allows the user to navigate and use the features. (Example: The Fault Code is accessed and displayed from "Screen 0" of the 7-segment display. The Fault History is accessed and display using "Screen 1" of the display, etc.)

<u>MODE</u>	<u>FUNCTION</u>	<u>DISPLAY SCREEN #</u>
<i>Fault Code Display</i>	Present fault (if any).	0 (Default)
<i>Fault Code History</i>	6 Recent faults stored.	1
<i>Monitoring Mode</i>	*Monitors system values.	2
<i>Setting Mode 1</i>	*Can change system settings	3
<i>Setting Mode 2</i>	*Can change system settings.	4

*\*See tables at the end of this section.*

## NAVIGATING THROUGH THE DISPLAY SCREENS

- SCREEN 0** The home or default screen on the display. This shows the most recent fault.
- SCREEN 1** To access, hold the RECALL button for 5 seconds at screen 0.
- SCREEN 2** To access, hold the RECALL button for 5 seconds at screen 1.
- SCREEN 3** To access, hold the RECALL button for 5 seconds at screen 2.
- SCREEN 4** To access, hold the RECALL and TEST buttons simultaneously for 5 seconds at screen 2.  
To return to SCREEN 0 of the display, press the LEARN button.

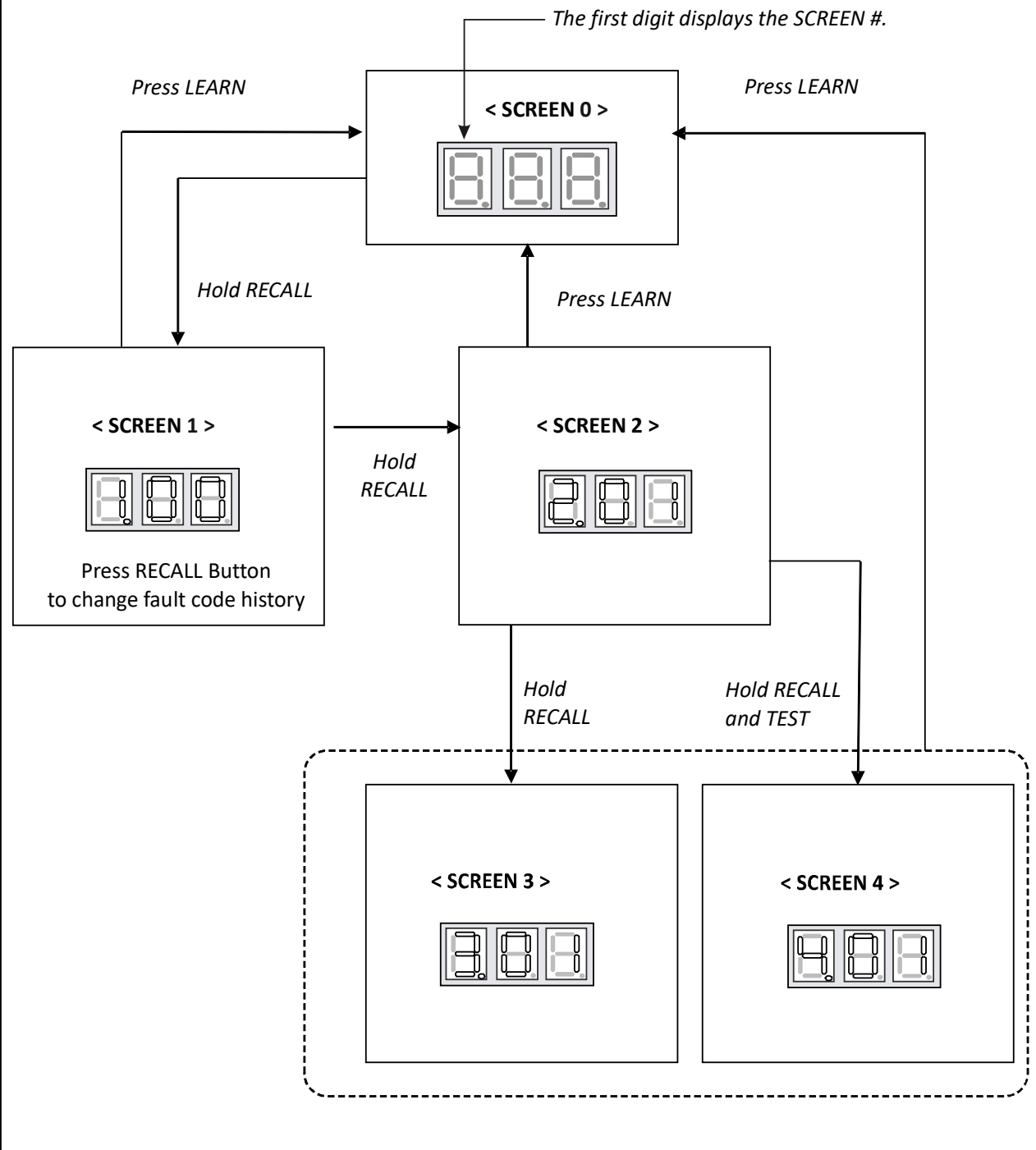

**FAULT CODE HISTORY NAVIGATION**

**< SCREEN 1 >**

This mode will allow the user to see the six most recent system faults.  
For a list of the fault codes, please see the TROUBLESHOOTING tables in this document.

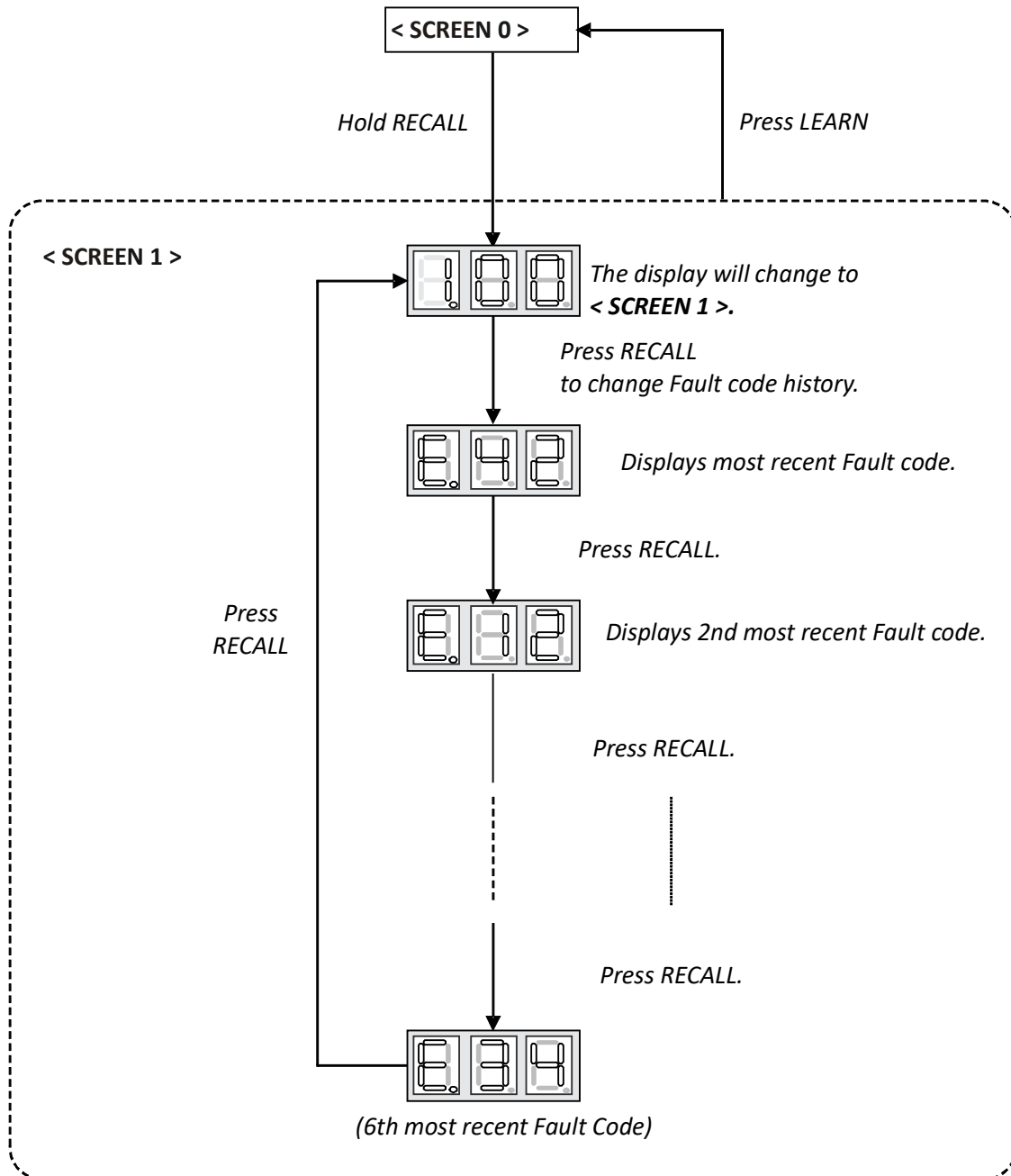



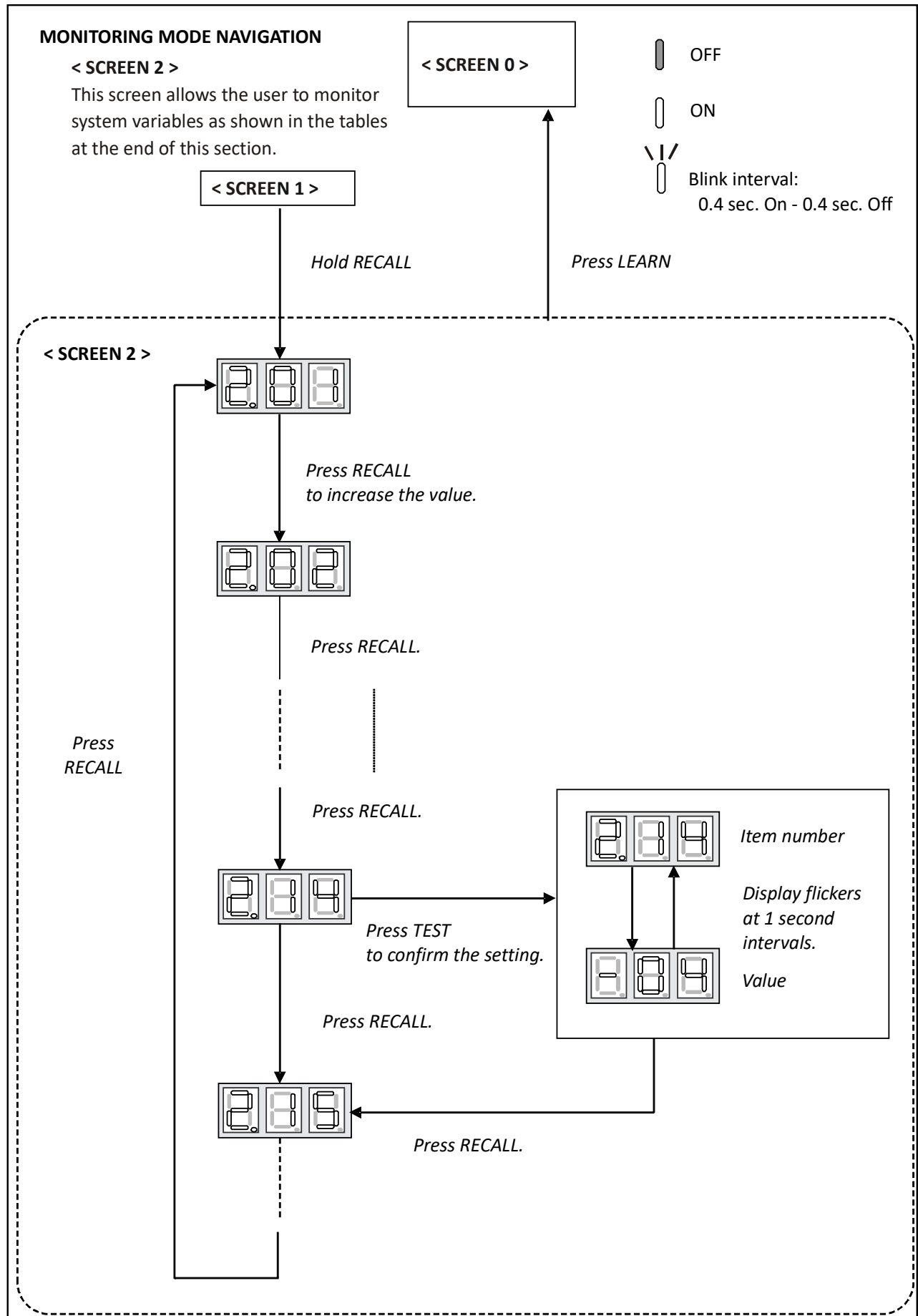

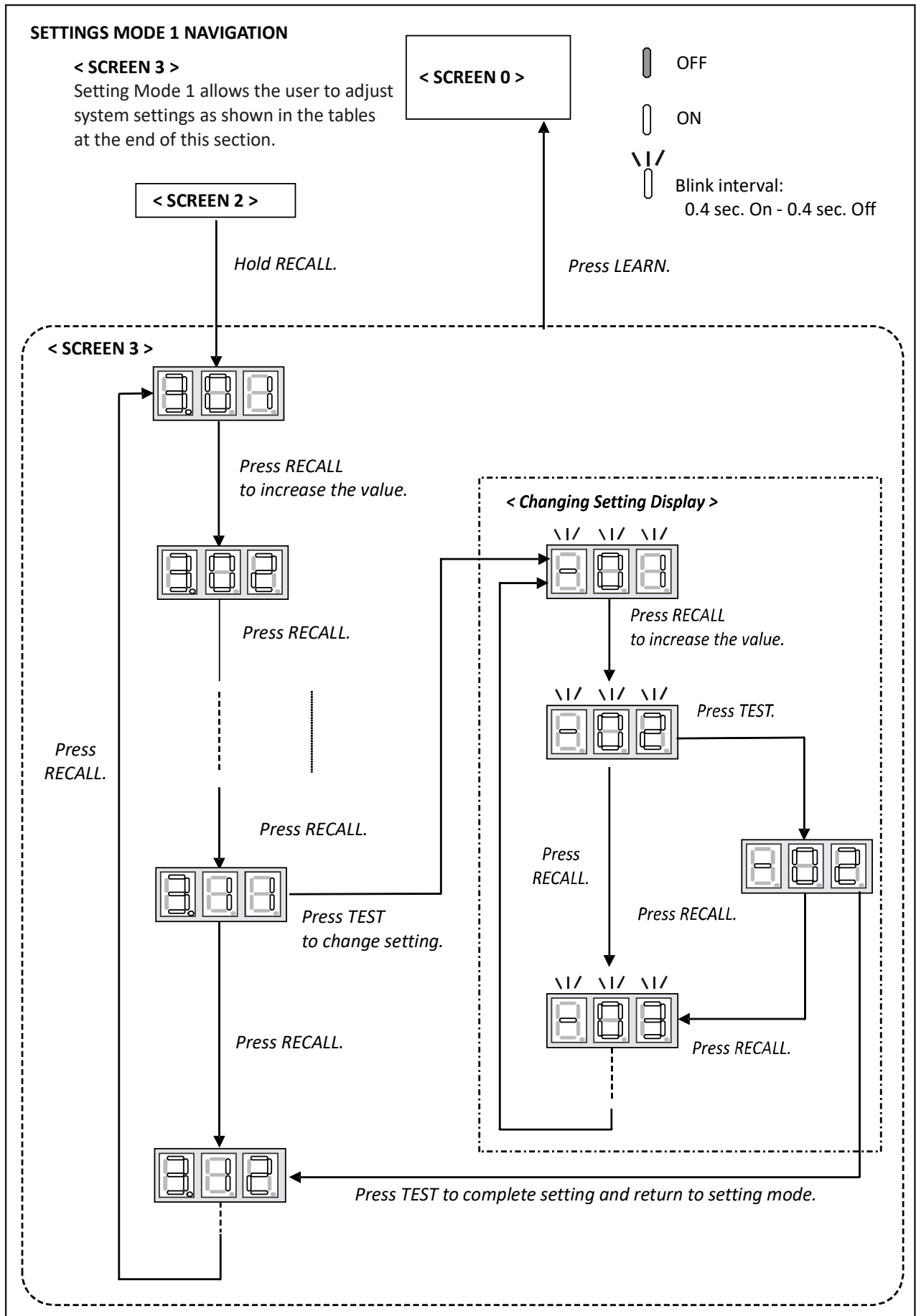

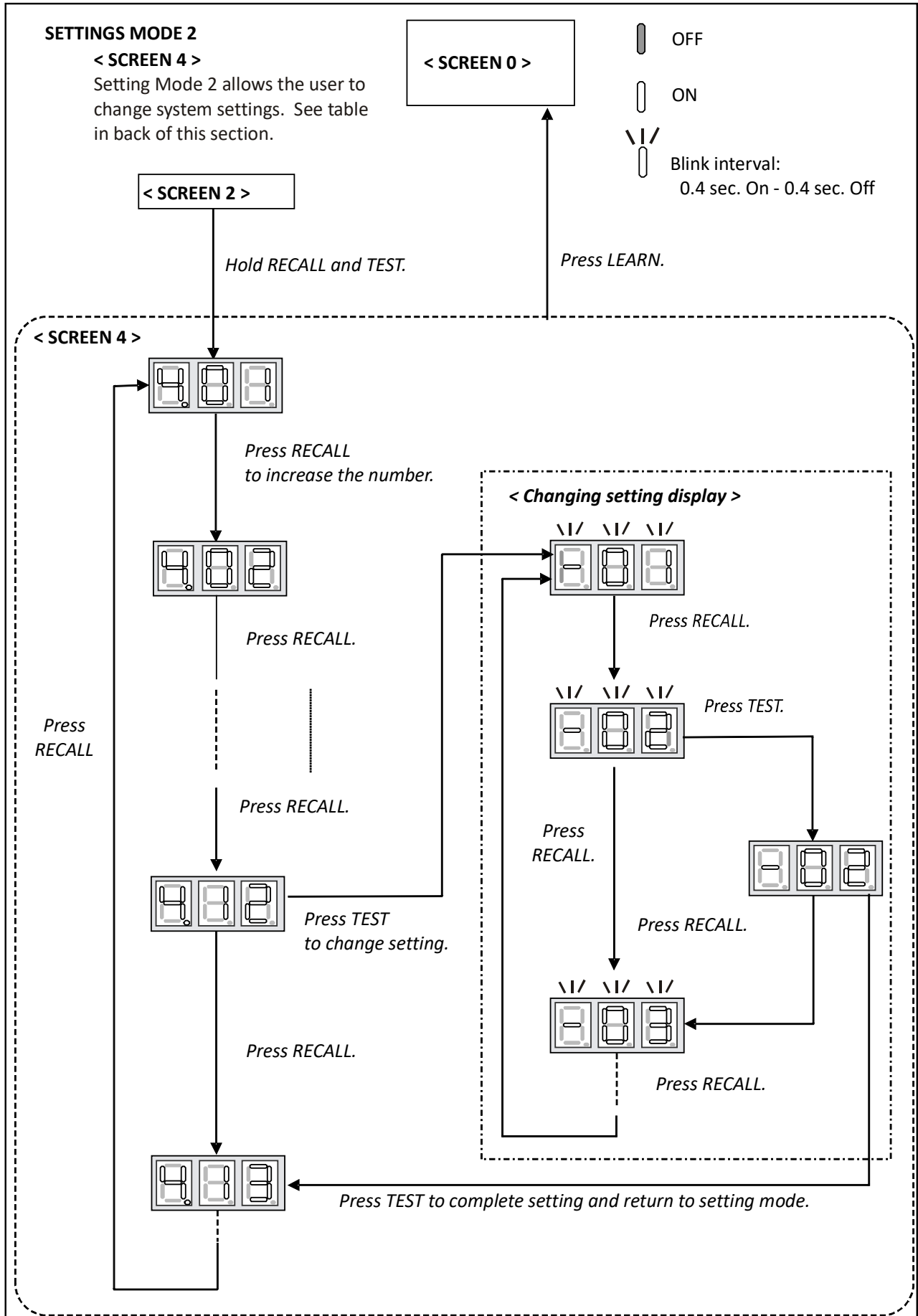

## SCREEN 0 (Display FAULT CODE)

Setting No.	Contents	Notes
1	Fault code (present)	

## SCREEN 1 (Display FAULT CODES)

Setting No.	Contents	Notes
1	Fault code (latest)	Latest
2	Fault code (2nd)	2nd
3	Fault code (3rd)	3rd
4	Fault code (4th)	4th
5	Fault code (5th)	5th
6	Fault code (6th)	6th

## SCREEN 2 (MONITOR MODE)

Setting No.	Contents	Notes
1	Compressor operation time	unit : hr (Multiply by 200,)
2	Operation code	0: Stop 1: Cooling Start-up 2: Heating Start-up 3: Oil Return Operation 4: Heating Operation 5: Defrost Operation 6: Cooling Operation
3	Compressor Reduction Mode	0:OFF,1:ON
4	% demand	unit : % (Cut off the decimal first place.)
5	act % demand	unit : % (Cut off the decimal first place.)
6	Requested ID CFM	unit : CFM (Multiply by 10)
7	Reported ID CFM	unit : CFM (Multiply by 10)
8	Outdoor FAN RPM	unit : RPM (Multiply by 10)
9	Ta (Outdoor Air Temperature)	unit : F
10	Td (Discharge Temperature)	unit : F
11	Tm (Outdoor Coil Temperature)	unit : F
12	Tb (Defrost Sensor Temperature)	unit : F
13	Tl (Liquid Temperature)	unit : F
14	Pressure Sensor	unit : PSI

# SERVICING

# 7-SEGMENT DISPLAY

## SCREEN 3 (SETTING MODE 1)

Setting No.	Contents	Setting	Installer / Serviceman Notes
1	Cool Airflow Trim High <sup>*1,*2</sup>	0: -15% 2: -5% 4: 5% 6: 15% 1: -10% <u>3: 0%</u> 5: 10%	
2	Cool Airflow Trim Int	0: -15% <u>3: 0%</u> 6: 15% 9: Full (Max) <sup>*3</sup> 1: -10% 4: 5% 7: 20% 2: -5% 5: 10% 8: 30%	
3	Cool Airflow Trim Low	0: -15% <u>3: 0%</u> 6: 15% 9: Full (Max) <sup>*3</sup> 1: -10% 4: 5% 7: 20% 2: -5% 5: 10% 8: 30%	
4	Cool Profile	0: A 1: B 2: C <u>3: D</u>	
5	Cool Fan ON Delay	<u>0: 5sec.</u> 1: 10sec. 2: 20sec. 3: 30sec.	
6	Cool Fan OFF Delay	<u>0: 30sec.</u> 1: 60sec. 2: 90sec. 3: 120sec.	
7	Dehumidification Select <sup>*4</sup>	<u>0: STD</u> 2: A 4: C 1: OFF 3: B	
13	Airflow Trim Offset <sup>*1,*2</sup>	<u>0: 0%</u> 1: +2.5%	Used for additional trim setting by adding 2.5% to basic airflow trim setting. This setting affects all trim settings except +15% High (cooling or heating).
14	Zoning Selection	<u>0: ON</u> 1: OFF	
15	Circulation Selection	<u>0: ON</u> 1: OFF	

**NOTE:** Parameters as per factory setting are highlighted in bold and underlined.

\*1 \*SXV906010\*\* with \*\*VC960804C, \*\*VM970804C and \*MVC800804C combination trim more than 5% settings are invalid.

Trimmed up CFM makes mismatching error.

\*2 Depending on the connected indoor unit, there are restrictions on the positive side Trim setting.

If you want to change the Cool Airflow Trim to positive side, be sure to confirm the Airflow Trim restrictions in the latest manual.

The latest manual can be obtained from the website "PartnerLink(InfoFinderPlus/Literature)".

[PartnerLink URL]

<https://partnerlinkmarketing.goodmanmfg.com/goodman/info-finder-plus>

\*3 The Inverter system uses lower compressor speed and lower indoor unit CFM to optimize system performance.

To obtain 100% CFM for home circulation, use full Trim setting instead of Int/Low speed.

This is recommended for applications with unusually cold return temperatures such as basements.

\*4 Please refer to the page of "Dehumidification Select" for details of this function.

# SERVICING

# 7-SEGMENT DISPLAY

## SCREEN 4 (SETTING MODE 2)

Setting No.	Contents	Setting	Installer / Serviceman Notes
1	Maximum Defrost Interval	0: 30min. 1: 60min. 2: 90min. 3: 120min.	
2	Set Maximum Current	N/A	Future Use
4	System Verification Test (System Test)	0:ON <b><u>1: OFF</u></b>	
7	Force Defrost Cycle	0:ON <b><u>1: OFF</u></b>	
8	Pump Down	0:ON <b><u>1: OFF</u></b>	
9	Charge Mode	0:ON <b><u>1: OFF</u></b>	
10	Maximum Compressor RPS for Cooling	*	
11	Maximum Compressor RPS for Heating	*	
12	BOOST MODE Selection	<b><u>0:ON</u></b> 1: OFF	
13	BOOST MODE Temperature	<b><u>0:105F,</u></b> 1:100F, 2:95F, 3:90F, 4:85F, 5:80F, 6:75F 7:70F 8: Always ON	

\*Depends on tonnage. Can adjust compressor RPS in each 0.5 RPS

### NOTES:

- Parameters as per factory setting are highlighted in bold and underlined.

## COOLING ANALYSIS CHART

POSSIBLE CAUSE  X IN ANALYSIS GUIDE INDICATE "POSSIBLE CAUSE"	Comp discharge temp > 200F	Comp discharge temp < 105F	Comp discharge SH > 70F	Comp discharge SH < 20F	High pressure > 490psi	High pressure < 255psi	LSV SC > 12F	LSV SC < 4F	OD SSV SH > 20F	OD SSV SH < 4F	Low pressure > 185psi	Low pressure < 100psi	Requested % demand < Actual	Requested % demand > Actual	Repeated stop/start	Weak cooling	No switch cooling	Noise	Stop operation
	Liquid stop valve does not fully open	X		X		X		X		X			X		X	X	X		X
Gas stop valve does not fully open	X		X									X		X	X	X			
Line set restriction	X		X		X		X		X			X		X	X	X		X	
Line set length is too long									X			X			X	X	X		X
Blocked filter-dryer	X		X		X		X		X			X		X	X	X		X	
OD EEV coil failure														X	X	X			X
OD EEV failure														X	X	X			
ID EEV coil failure	X	X	X	X	X	X	X	X	X	X	X	X	X	X	X	X			X
ID EEV failure	X	X	X	X	X	X	X	X	X	X	X	X	X	X	X	X			
Check valve failure – Blocked	X		X		X			X	X			X		X	X	X			
High Pressure switch failure																			X
Pressure sensor failure	X										X	X		X	X	X			X
Discharge temp sensor failure	X	X	X	X									X	X	X	X			X
Coil temp sensor failure				X	X	X							X	X	X	X			X
Defrost sensor failure																			
Liquid temp sensor failure																			
Ambient temp sensor failure				X	X	X							X	X	X	X			
OD recirculation	X		X		X									X	X	X		X	
ID recirculation		X		X					X			X	X	X	X	X			
Dirty OD Heat-exchanger	X		X		X									X	X	X			X
Dirty ID Heat-exchanger		X		X				X		X		X	X	X	X	X			
Outdoor Ambient temp is too high	X		X		X				X					X	X	X			X
Outdoor Ambient temp is too low		X		X		X	X					X	X	X	X	X			
ID suction temp is too high								X		X									
ID suction temp is too low		X		X				X		X		X	X	X	X	X			
Mixture of non-condensable gas	X		X		X			X	X			X		X	X	X			X
OD fan motor failure	X		X		X			X						X	X	X		X	X
RV failure	X		X		X						X			X	X	X	X		X
RV coil failure	X		X		X						X			X	X	X	X		X
Over charge	X	X	X	X	X		X		X				X			X			X
Under charge	X	X	X		X		X	X				X				X			X
Leak	X	X	X		X		X	X				X		X	X	X			X
TXV failure	X	X	X	X	X	X	X	X	X	X	X	X	X	X	X	X			
TXV is small	X		X		X		X		X			X							
TXV is big		X		X		X		X	X			X				X			
OD Control Board Failure																			X
ID Failure	X	X	X	X	X	X	X	X	X	X	X	X	X	X	X	X	X	X	X
Compressor failure	X	X	X		X						X			X	X	X		X	X
Cooling loop is not attached														X	X	X			
Cooling loop grease is not enough														X	X	X			
Compressor and Gas furnace are operating at the same time																			X
Low ID CFM		X		X					X		X	X	X	X	X	X			X

Outdoor Normal Temperature Operating Range: 67-115°F / Indoor Normal Temperature Operating Range: 65 - 85°F

### WARNING

**AVOID CONTACT WITH THE CHARGED AREA.**

•NEVER TOUCH THE CHARGED AREA BEFORE CONFIRMING THAT THE RESIDUAL VOLTAGE IS 50 VOLTS OR LESS.

1. SHUT DOWN THE POWER AND LEAVE THE CONTROL BOX FOR 10 MINUTES.
2. MAKE SURE TO TOUCH THE EARTH GROUND TERMINAL TO RELEASE THE STATIC ELECTRICITY FROM YOUR BODY (TO PREVENT FAILURE OF THE PC BOARD).
3. MEASURE THE RESIDUAL VOLTAGE IN THE SPECIFIED MEASUREMENT POSITION USING A VOM WHILE PAYING ATTENTION NOT TO TOUCH THE CHARGED AREA.
4. IMMEDIATELY AFTER MEASURING THE RESIDUAL VOLTAGE, DISCONNECT THE CONNECTORS OF THE OUTDOOR UNIT'S FAN MOTOR. (IF THE FAN BLADE ROTATES BY STRONG WIND BLOWING AGAINST IT, THE CAPACITOR WILL BE CHARGED, CAUSING THE DANGER OF ELECTRICAL SHOCK.)

## HEATING ANALYSIS CHART

POSSIBLE CAUSE  X IN ANALYSIS GUIDE INDICATE "POSSIBLE CAUSE"	Comp discharge temp > 200F	Comp discharge temp < 105F	Comp discharge SH > 70F	Comp discharge SH < 20F	High pressure > 490psi	High pressure SSV < 270psi	High pressure LSV < 270psi	LSV SC > 12F	LSV SC < 4F	Low pressure < 40psi	Requested % demand < Actual %	Requested % demand > Actual %	Repeated stop/start	Weak heating	No switch heating	Noise	Incomplete defrost operation	Stop operation	Sweating liquid line
	Liquid stop valve does not fully open	X		X		X					X			X	X			X	
Gas stop valve does not fully open	X		X		X				X	X			X	X			X		
Line set restriction	X		X		X				X	X			X	X			X		X
Line set length is too long					X		X												X
Blocked filter-dryer	X		X		X				X	X			X	X			X		X
OD EEV coil failure	X	X	X	X	X	X	X	X	X	X	X	X	X	X			X	X	
OD EEV failure	X	X	X	X	X	X	X	X	X	X	X	X	X	X			X	X	
ID EEV coil failure	X		X		X		X		X	X	X	X	X	X			X	X	X
ID EEV failure	X		X		X		X		X	X	X	X	X	X			X	X	X
Check valve failure – Leakage		X		X					X		X		X	X				X	
High Pressure switch failure																		X	
Pressure sensor failure			X	X	X	X	X	X			X	X	X	X				X	
Discharge temp sensor failure	X	X	X	X							X	X	X	X				X	
Coil temp sensor failure										X		X	X	X			X	X	
Defrost sensor failure										X		X	X	X			X	X	
Liquid temp sensor failure								X	X									X	X
Ambient temp sensor failure					X					X		X	X	X				X	X
OD recirculation	X		X			X	X			X		X	X	X					
ID recirculation	X		X		X							X	X	X					
Dirty OD Heat-exchanger	X		X			X	X			X		X	X	X					
Dirty ID Heat-exchanger	X		X		X							X	X	X					
Outdoor Ambient temp is too high					X							X	X	X				X	X
Outdoor Ambient temp is too low	X	X	X			X	X		X	X			X	X	X				
ID suction temp is too high	X				X							X	X	X					
ID suction temp is too low						X	X												X
Mixture of non-condensable gas	X		X		X				X	X		X	X	X					
OD fan motor failure	X		X							X		X	X	X				X	
RV failure			X			X	X					X	X	X	X		X	X	
RV coil failure			X			X	X					X	X	X	X		X	X	
Over charge			X	X	X		X				X	X	X	X				X	X
Under charge	X	X	X			X	X		X	X			X	X					X
Leak	X	X	X			X	X		X	X			X	X					X
TXV failure	X		X		X				X	X		X	X	X					
TXV size is small																			X
TXV size is big																			
ID failure	X	X	X	X	X	X	X	X	X	X	X	X	X	X		X	X	X	X
OD Control Board failure																		X	
Compressor failure	X	X	X	X		X	X					X	X	X		X	X	X	
Cooling loop is not attached												X	X	X					
Cooling loop grease is not enough												X	X	X					
Compressor and Gas furnace are operating at the same time																		X	X
Low ID CFM	X				X				X			X	X	X				X	

Outdoor Normal Temperature Operating Range: 17-62°F / Indoor Normal Temperature Operating Range: 65 - 85°F

### WARNING

**AVOID CONTACT WITH THE CHARGED AREA.**

•NEVER TOUCH THE CHARGED AREA BEFORE CONFIRMING THAT THE RESIDUAL VOLTAGE IS 50 VOLTS OR LESS.

1. SHUT DOWN THE POWER AND LEAVE THE CONTROL BOX FOR 10 MINUTES.
2. MAKE SURE TO TOUCH THE EARTH GROUND TERMINAL TO RELEASE THE STATIC ELECTRICITY FROM YOUR BODY (TO PREVENT FAILURE OF THE PC BOARD).
3. MEASURE THE RESIDUAL VOLTAGE IN THE SPECIFIED MEASUREMENT POSITION USING A VOM WHILE PAYING ATTENTION NOT TO TOUCH THE CHARGED AREA.
4. IMMEDIATELY AFTER MEASURING THE RESIDUAL VOLTAGE, DISCONNECT THE CONNECTORS OF THE OUTDOOR UNIT'S FAN MOTOR. (IF THE FAN BLADE ROTATES BY STRONG WIND BLOWING AGAINST IT, THE CAPACITOR WILL BE CHARGED, CAUSING THE DANGER OF ELECTRICAL SHOCK.)



# TROUBLESHOOTING

# OUTDOOR UNIT ERROR CODES

Fault Code	Control Board LED Display	Transmitted Climate Talk Message	Thermostat Fault	Probable Causes	Corrective Actions
12	E12	OD CTRL FAIL1	Indicates a general memory error.	<ul style="list-style-type: none"> <li>High electrical noise</li> <li>Faulty control board</li> </ul>	<ul style="list-style-type: none"> <li>Replace control board if necessary</li> </ul>
13	E13	HI PRESSURE C (C = CRITICAL)	This error indicates the equipment is experiencing frequent high pressure faults.	<ul style="list-style-type: none"> <li>Blocked/restricted condenser coil and/or lines</li> <li>Stop valve not completely open</li> <li>Overcharge</li> <li>Outdoor fan not running</li> <li>High pressure switch (HPS) inoperable</li> <li>Faulty TXV</li> <li>Faulty control board</li> </ul>	<ul style="list-style-type: none"> <li>Check and clean condenser coil and/or lines</li> <li>Check the opening of stop valve, should be full open; Repair/replace if needed</li> <li>Check refrigerant charge level; Adjust if needed</li> <li>Check outdoor fan motor &amp; wiring; Repair/replace if needed</li> <li>Check TXV; Replace if needed</li> <li>Replace control board if necessary</li> </ul>
14	-	HI PRESSURE M (M = MINOR)	This error indicates the equipment is experiencing frequent high pressure faults. Control has determined continued operation is acceptable. This indicates they may be a problem with the equipment.	<ul style="list-style-type: none"> <li>Blocked/restricted condenser coil and/or lines</li> <li>Stop valve not completely open</li> <li>Overcharge</li> <li>Outdoor fan not running</li> <li>High pressure switch (HPS) inoperable</li> <li>Faulty TXV</li> <li>Faulty control board</li> </ul>	<ul style="list-style-type: none"> <li>Check and clean condenser coil and/or lines</li> <li>Check the opening of stop valve, should be full open; Repair/replace if needed</li> <li>Check refrigerant charge level; Adjust if needed</li> <li>Check outdoor fan motor &amp; wiring; Repair/replace if needed</li> <li>Check TXV; Replace if needed</li> <li>Replace control board if necessary</li> <li>Check high pressure switch; Replace if necessary</li> </ul>
15	E15	LOW PRESSURE C	This error indicates the equipment is experiencing frequent low pressure faults.	<ul style="list-style-type: none"> <li>Stop valve not completely open</li> <li>Restriction in refrigerant lines</li> <li>Low refrigerant charge</li> <li>Refrigerant leak</li> <li>Low pressure sensor inoperable or not properly connected</li> <li>Indoor fan motor not functioning correctly</li> <li>Faulty TXV</li> <li>Faulty control board</li> </ul>	<ul style="list-style-type: none"> <li>Check the opening of stop valve, should be full open; Repair/replace if needed</li> <li>Check for restrictions in refrigerant line; Repair/replace if needed</li> <li>Check refrigerant charge level; Adjust if needed</li> <li>Test for system leaks using leak test procedure</li> <li>Check the connection to low pressure sensor; Repair/replace if needed</li> <li>Check TXV; Replace if needed</li> <li>Check indoor blower motor &amp; wiring; Repair/replace if needed</li> <li>Replace control board if necessary</li> </ul>
16	-	LOW PRESSURE M	This error indicates the equipment is experiencing frequent low pressure faults. Control has determined continued operation is acceptable. This indicates they may be a problem with the equipment.	<ul style="list-style-type: none"> <li>Stop valve not completely open</li> <li>Restriction in refrigerant lines</li> <li>Low refrigerant charge</li> <li>Refrigerant leak</li> <li>Low pressure sensor inoperable or not properly connected</li> <li>Indoor fan motor not functioning correctly</li> <li>Faulty TXV</li> <li>Faulty control board</li> </ul>	<ul style="list-style-type: none"> <li>Check the opening of stop valve, should be full open; Repair/replace if needed</li> <li>Check for restrictions in refrigerant line; Repair/replace if needed</li> <li>Check refrigerant charge level; Adjust if needed</li> <li>Test for system leaks using leak test procedure</li> <li>Check the connection to low pressure sensor; Repair/replace if needed</li> <li>Check TXV; Replace if needed</li> <li>Check indoor blower motor &amp; wiring; Repair/replace if needed</li> <li>Replace control board if necessary</li> </ul>
17	E17	COMPRESSOR FAIL	This error indicates the equipment is experiencing frequent compressor faults.	<ul style="list-style-type: none"> <li>Stop valve not completely open</li> <li>The compressor wire is lost phase</li> <li>Compressor motor failure</li> </ul>	<ul style="list-style-type: none"> <li>Check the opening of stop valve, should be full open; Repair/replace if needed</li> <li>Check the wire between control board and compressor</li> <li>Inspect compressor motor for proper function; Replace if necessary</li> </ul>
18	E18	OD CTRL FAIL2	Indicates the control board may need to be replaced.	<ul style="list-style-type: none"> <li>Outdoor fan motor not connected properly</li> <li>Faulty control board</li> <li>Noise</li> </ul>	<ul style="list-style-type: none"> <li>Check wiring from Outdoor fan motor to control board; Repair if needed.</li> <li>Replace control board if necessary</li> </ul>
19	E19	PCB OR FAN FAIL	This error indicates the equipment is experiencing frequent outdoor control board and/or motor faults.	<ul style="list-style-type: none"> <li>Obstruction in fan rotation</li> <li>Outdoor fan motor not connected properly</li> <li>Outdoor fan not running</li> <li>Faulty control board</li> <li>Noise</li> </ul>	<ul style="list-style-type: none"> <li>Check and clean grille or any debris</li> <li>Check wiring from Outdoor fan motor to control board; Repair if needed</li> <li>Check outdoor fan motor &amp; wiring. Repair/replace if needed</li> <li>Replace control board if necessary</li> </ul>
20	E20	EEV OPEN CKT	EEV coil is not connected.	<ul style="list-style-type: none"> <li>Outdoor EEV coil is not connected.</li> <li>Faulty outdoor EEV coil.</li> </ul>	<ul style="list-style-type: none"> <li>Check outdoor EEV coil connection. Repair/replace as needed.</li> </ul>
21	E21	EEV CTRL FAIL	This error indicates the equipment is experiencing frequent low discharge superheat faults.	<ul style="list-style-type: none"> <li>Thermistors inoperable or improperly connected</li> <li>Faulty TXV</li> <li>Faulty outdoor EEV coil</li> <li>Faulty outdoor EEV</li> <li>Over charge</li> <li>Faulty pressure sensor</li> <li>Faulty control board</li> </ul>	<ul style="list-style-type: none"> <li>Check the connection to thermistors; Repair/replace if needed</li> <li>Check TXV; Replace/repair if needed</li> <li>Check outdoor EEV coil; Repair/replace if needed</li> <li>Check outdoor EEV; Replace/repair if needed</li> <li>Check refrigerant charge level; Adjust if needed</li> <li>Check pressure sensor; Repair/replace if needed</li> <li>Replace control board if necessary</li> </ul>

# TROUBLESHOOTING

# OUTDOOR UNIT ERROR CODES

Fault Code	Control Board LED Display	Transmitted Climate Talk Message	Thermostat Fault	Probable Causes	Corrective Actions
22	E22	HI DISCH TEMP	This error indicates the equipment is experiencing frequent high discharge temperature faults. Discharge thermistor is not put on correct position.	<ul style="list-style-type: none"> <li>Discharge thermistor inoperable or improperly connected</li> <li>Discharge thermistor is put on incorrect position or off</li> <li>Low refrigerant charge</li> <li>Overcharge</li> <li>Faulty compressor</li> </ul>	<ul style="list-style-type: none"> <li>Check discharge thermistor resistance and connections; Repair/replace as needed</li> <li>Check discharge thermistor position</li> <li>Check refrigerant charge level; Adjust if needed</li> <li>Check the compressor; Repair/replace if needed</li> </ul>
23	E23	DISCH TEMP FAIL	The control has detected that the Discharge Temperature Sensor is out of range.	<ul style="list-style-type: none"> <li>Discharge thermistor inoperable or improperly connected</li> </ul>	<ul style="list-style-type: none"> <li>Check discharge thermistor resistance and connections; Repair/replace as needed</li> </ul>
24	E24	HPS OPEN	The high pressure switch is open.	<ul style="list-style-type: none"> <li>High pressure switch (HPS) inoperable</li> </ul>	<ul style="list-style-type: none"> <li>Check resistance on HPS to verify operation; Replace if needed</li> </ul>
25	E25	AIR SENSOR FLT	The outdoor air temperature sensor is open or shorted.	<ul style="list-style-type: none"> <li>Faulty outdoor thermistor sensor or disconnect</li> </ul>	<ul style="list-style-type: none"> <li>Inspect and test sensor; Replace sensor if needed</li> </ul>
26	E26	PRESSURE SENSOR	The control determines that the pressure sensor is not reacting properly.	<ul style="list-style-type: none"> <li>Low pressure sensor inoperable or not properly connected</li> </ul>	<ul style="list-style-type: none"> <li>Check the connection to low pressure sensor; Repair/replace if needed</li> </ul>
27	E27	COIL TEMP FAIL1	The control detects that the Outdoor Defrost Sensor is out of range.	<ul style="list-style-type: none"> <li>Outdoor defrost thermistor inoperable or not properly connected</li> </ul>	<ul style="list-style-type: none"> <li>Check the connection to OD defrost thermistor; Repair as needed</li> </ul>
28	E28	COIL TEMP FAIL2	The control has detected that the Outdoor Coil Temperature Sensor is out of range.	<ul style="list-style-type: none"> <li>Outdoor coil thermistor inoperable or not properly connected</li> </ul>	<ul style="list-style-type: none"> <li>Check the connection to OD coil thermistor; Repair/replace if needed</li> </ul>
29	E29	LIQ TEMP FAIL	The control has detected that the Liquid Temperature Sensor is out of range.	<ul style="list-style-type: none"> <li>Liquid thermistor inoperable or not properly connected</li> </ul>	<ul style="list-style-type: none"> <li>Check the connection to liquid thermistor; Repair/replace if needed</li> </ul>
30	E30	OD CTRL FAIL3	Indicates the control board may need to be replaced.	<ul style="list-style-type: none"> <li>Wiring to control board disconnected</li> <li>Faulty control board</li> <li>Noise</li> </ul>	<ul style="list-style-type: none"> <li>Check wiring to control board; Repair as needed</li> <li>Replace control board if necessary</li> </ul>
31	E31	HI LEAK CURRENT	The control has detected high leakage current (high voltage).	<ul style="list-style-type: none"> <li>Improper ground</li> <li>Faulty compressor</li> </ul>	<ul style="list-style-type: none"> <li>Check ground screws/lugs and wiring; Repair/replace if needed</li> <li>Check the compressor; Repair/replace if needed</li> </ul>
32 <sup>2</sup>	E32	HI TEMP CTRL1	This error indicates the equipment is experiencing high temperature faults on the outdoor control board.	<ul style="list-style-type: none"> <li>Ambient air conditions too high</li> <li>Cooling bracket screw(s) missing or not properly fastened (2-4 ton only)</li> <li>No or poor thermal grease coating between cooling plumbing and cooling bracket on control board (2-4 ton only)</li> <li>Outdoor fan low speed (5 ton only)</li> <li>No flow or limited flow through control board cooling circuit (potential restriction in line or low refrigerant) (2-4 ton only)</li> <li>Stop valve not completely open (2-4 ton only)</li> </ul>	<ul style="list-style-type: none"> <li>Cycle power; re-try during usable ambient temperature range</li> <li>Verify cooling bracket screws in place and secure; Secure fasteners as needed (2-4 ton only)</li> <li>Check thermal grease inside cooling bracket on control board; Apply additional grease as needed</li> <li>Check outdoor fan motor &amp; wiring; Repair/replace if needed (5 ton only)</li> <li>Check for restriction in line</li> <li>Check refrigerant charge level; Adjust if needed (2-4 ton only)</li> <li>Check the opening of stop valve, should be full open; Repair/replace if needed (2-4 ton only)</li> </ul>
33 <sup>2</sup>	-	HI TEMP CTRL2	This error indicates the equipment is experiencing high temperature faults on the outdoor control board. Control has determined continued operation is acceptable. This indicates they may be a problem with the equipment.	<ul style="list-style-type: none"> <li>Ambient air conditions too high</li> <li>Cooling bracket screw(s) missing or not properly fastened (2-4 ton only)</li> <li>No or poor thermal grease coating between cooling plumbing and cooling bracket on control board (2-4 ton only)</li> <li>Outdoor fan low speed (5 ton only)</li> <li>No flow or limited flow through control board cooling circuit (potential restriction in line or low refrigerant) (2-4 ton only)</li> <li>Stop valve not completely open (2-4 ton only)</li> </ul>	<ul style="list-style-type: none"> <li>Cycle power; re-try during usable ambient temperature range</li> <li>Verify cooling bracket screws are in place and secure; Secure fasteners as needed (2-4 ton only)</li> <li>Check thermal grease inside cooling bracket on control board; Apply additional grease as needed</li> <li>Check outdoor fan motor &amp; wiring; Repair/replace if needed (5 ton only)</li> <li>Check for restriction in line</li> <li>Check refrigerant charge level; Adjust if needed (2-4 ton only)</li> <li>Check the opening of stop valve - it should be fully open; Repair/replace if needed (2-4 ton only)</li> </ul>
34	E34	CURRENT SPIKE	Board detected a high current condition. This indicates the potential for a short circuit.	<ul style="list-style-type: none"> <li>Current spike in supply</li> <li>Stop valve not completely open</li> <li>The compressor wire is lost phase</li> <li>Faulty control board</li> <li>Faulty compressor</li> </ul>	<ul style="list-style-type: none"> <li>Check power supply for in-rush current during start-up or steady state operation</li> <li>Check the opening of stop valve, should be full open; Repair/replace if needed</li> <li>Check the wire between control board and compressor</li> <li>Replace control board if necessary</li> <li>Check the compressor; Repair/replace if needed</li> </ul>

Fault Code	Control Board LED Display	Transmitted Climate Talk Message	Thermostat Fault	Probable Causes	Corrective Actions
35	E35	HIGH CURRENT	Board detected a high current condition.	<ul style="list-style-type: none"> <li>Short circuit condition</li> <li>Stop valve not completely open</li> <li>Overcharge</li> <li>Faulty control board</li> <li>Faulty compressor</li> </ul>	<ul style="list-style-type: none"> <li>Check installation clearances.</li> <li>Check the opening of stop valve, should be full open; Repair/replace if needed</li> <li>Check refrigerant charge level; Adjust if needed</li> <li>Replace control board if necessary</li> <li>Check the compressor; Repair/replace if needed.</li> </ul>
36	E36	STARTUP ERROR	The control encountered an abnormal condition during the startup procedure.	<ul style="list-style-type: none"> <li>Blocked/restricted condenser coil and/or lines</li> <li>The compressor wire is lost phase</li> <li>Inconsistent compressor load</li> <li>Faulty control board</li> </ul>	<ul style="list-style-type: none"> <li>Check and clean condenser coil and/or lines</li> <li>Check the wire between control board and compressor</li> <li>Replace control board if necessary</li> </ul>
37	E37	OD CTRL FAIL4	Indicates the control board may need to be replaced.	<ul style="list-style-type: none"> <li>Outdoor fan motor not connected properly</li> <li>Faulty control board</li> </ul>	<ul style="list-style-type: none"> <li>Check wiring from outdoor fan motor to control board; Repair if needed</li> <li>Replace control board if necessary</li> </ul>
38	E38	COMP VOLTAGE	The control has detected a voltage related issue with the compressor.	<ul style="list-style-type: none"> <li>High or low voltage from supply</li> <li>The compressor wire is lost phase</li> <li>Faulty control board</li> </ul>	<ul style="list-style-type: none"> <li>Correct low/high line voltage condition; Contact local utility if needed</li> <li>Check the wire between control board and compressor</li> <li>Replace control board if necessary</li> </ul>
39	E39	OD CTRL FAIL5	Indicates the control board may need to be replaced.	<ul style="list-style-type: none"> <li>Thermistors inoperable or improperly connected</li> <li>Faulty control board</li> </ul>	<ul style="list-style-type: none"> <li>Check the connection to thermistors; Repair/replace if needed</li> <li>Replace control board if necessary</li> </ul>
40	E40	COMP MISMATCH	Control determines that its compressor requirement is different than the compressor capability.	<ul style="list-style-type: none"> <li>Bluetooth® Shared Data Loader BTSDL01 not correct</li> <li>Control board mismatch</li> </ul>	<ul style="list-style-type: none"> <li>Check Bluetooth® Shared Data Loader BTSDL01 data vs. air conditioner model</li> <li>Verify control board size vs. air conditioner model; Replace control board if necessary</li> </ul>
41	E41	LOW REFRIGERANT	The control has detected a low refrigerant condition.	<ul style="list-style-type: none"> <li>Refrigerant leak</li> <li>Low refrigerant charge</li> <li>Thermistors inoperable or not properly connected</li> </ul>	<ul style="list-style-type: none"> <li>Test for system leaks using leak test procedure</li> <li>Check refrigerant charge level; Adjust if needed</li> <li>Check the connection to thermistor; Repair/replace if needed</li> </ul>
42	E42	LOW LINE VOLT	Control detects a low power supply voltage condition.	<ul style="list-style-type: none"> <li>Low line voltage supply</li> </ul>	<ul style="list-style-type: none"> <li>Check circuit breakers and fuses; Replace if needed</li> <li>Verify unit is connected to power supply as specified on rating plate</li> <li>Correct low line voltage condition; Contact local utility if needed</li> </ul>
43	E43	HIGH LINE VOLT	Control detects a high power supply voltage condition.	<ul style="list-style-type: none"> <li>High line voltage supply</li> </ul>	<ul style="list-style-type: none"> <li>Verify unit is connected to power supply as specified on rating plate</li> <li>Correct high line voltage condition; Contact local utility if needed</li> </ul>
44	E44	OP TEMP RANGE	The control detects the outdoor temperature outside recommended operational range. Unit may continue to operate normally.	<ul style="list-style-type: none"> <li>Ambient air conditions too high or low</li> </ul>	<ul style="list-style-type: none"> <li>Cycle power; re-try during usable ambient temperature range</li> </ul>
45	E45	NO COOLING TEST	The control is unable to start the Cooling mode test because indoor heat has been turned on by thermostat. Please set thermostat to off position.	<ul style="list-style-type: none"> <li>Heat provided by secondary heating source</li> </ul>	<ul style="list-style-type: none"> <li>Turn off heater using thermostat before running AHRI mode</li> </ul>
46	E46	NO HEATING TEST	The control is unable to start the Heating mode test because indoor heat has been turned on by thermostat. Please set thermostat to off position.	<ul style="list-style-type: none"> <li>Heat provided by secondary heating source</li> </ul>	<ul style="list-style-type: none"> <li>Turn off heater using thermostat before running AHRI mode</li> </ul>
47	E47	NO SYS VER TEST	The control is unable to start the System Verification test because indoor heat has been turned on by thermostat. Please set thermostat to off position.	<ul style="list-style-type: none"> <li>Heat provided by secondary heating source</li> </ul>	<ul style="list-style-type: none"> <li>Turn off heater using thermostat before operation</li> </ul>
48	E48	NO PUMP DOWN	The control is unable to enter the Pump Down Mode because indoor heat has been turned on by thermostat. Please set thermostat to off position.	<ul style="list-style-type: none"> <li>Heat provided by secondary heating source</li> </ul>	<ul style="list-style-type: none"> <li>Turn off heater using thermostat before operation</li> </ul>
49	E49	NO CHARGE MODE	The control is unable to enter Charging Mode because indoor heat has been turned on by thermostat. Please set thermostat to off position.	<ul style="list-style-type: none"> <li>Heat provided by secondary heating source</li> </ul>	<ul style="list-style-type: none"> <li>Turn off heater using thermostat before operation</li> </ul>
50	E50	LINE VOLT CTRL	This indicates there is a voltage issue on the control board. See service manual for troubleshooting information.	<ul style="list-style-type: none"> <li>High or low voltage from supply</li> <li>Faulty control board</li> </ul>	<ul style="list-style-type: none"> <li>Correct low/high line voltage condition; Contact local utility if needed</li> <li>Replace control board if necessary</li> </ul>
51 <sup>+2</sup>	E51	OD COMM ERROR	This indicates potential communication issues have been detected by the outdoor control board.	<ul style="list-style-type: none"> <li>Communication wiring disconnected</li> </ul>	<ul style="list-style-type: none"> <li>Check communication wiring; Repair as needed</li> </ul>
52	-	COMP FAIL MINOR	This error indicates the equipment is experiencing frequent compressor faults. Control has determined continued operation is acceptable. This indicates they may be a problem with the equipment.	<ul style="list-style-type: none"> <li>Stop valve not completely open</li> <li>The compressor wire is lost phase</li> <li>Compressor motor failure</li> </ul>	<ul style="list-style-type: none"> <li>Check the opening of stop valve, should be full open; Repair/replace if needed</li> <li>Check the wire between control board and compressor</li> <li>Inspect compressor motor for proper function; Replace if necessary</li> </ul>

# TROUBLESHOOTING

# OUTDOOR UNIT ERROR CODES

Fault Code	Control Board LED Display	Transmitted Climate Talk Message	Thermostat Fault	Probable Causes	Corrective Actions
53	-	PCB PR FAN MIN	This error indicates the equipment is experiencing frequent outdoor control board and/or motor faults. Control has determined continued operation is acceptable. This indicates there may be a problem with the equipment.	<ul style="list-style-type: none"> <li>Obstruction in fan rotation</li> <li>Outdoor fan motor not connected properly</li> <li>Outdoor fan not running</li> <li>Faulty control board</li> <li>Noise</li> </ul>	<ul style="list-style-type: none"> <li>Check and clean grille of any debris</li> <li>Check wiring from outdoor fan motor to control board; Repair if needed</li> <li>Check outdoor fan motor &amp; wiring; Repair/replace if needed</li> <li>Replace control board if necessary</li> </ul>
54	-	EEV MINOR	This error indicates the equipment is experiencing frequent low discharge superheat faults. Control has determined continued operation is acceptable. This indicates they may be a problem with the equipment.	<ul style="list-style-type: none"> <li>Thermistors inoperable or improperly connected</li> <li>Faulty TXV</li> <li>Faulty control board</li> </ul>	<ul style="list-style-type: none"> <li>Check the connection to thermistors; Repair/replace if needed</li> <li>Check TXV; Replace if needed</li> <li>Replace control board if necessary</li> </ul>
55	-	HI DIS TEMP MIN	This error indicates the equipment is experiencing frequent high discharge temperature faults. Control has determined continued operation is acceptable. This indicates they may be a problem with the equipment.	<ul style="list-style-type: none"> <li>Discharge thermistor inoperable or improperly connected</li> <li>Discharge thermistor is put on incorrect position or off</li> <li>Low refrigerant charge</li> <li>Overcharge</li> <li>Faulty compressor</li> </ul>	<ul style="list-style-type: none"> <li>Check discharge thermistor resistance and connections; Repair/replace as needed</li> <li>Check discharge thermistor position</li> <li>Check refrigerant charge level; Adjust if needed</li> <li>Check refrigerant charge level; Adjust if needed</li> <li>Check the compressor; Repair/replace if needed</li> </ul>
57	-	CL LOOP SWEAT	This indicates the control is sensing sweating on the cooling loop.	<ul style="list-style-type: none"> <li>Refrigerant Leak</li> <li>Low refrigerant charge</li> <li>Faulty TXV</li> <li>Thermistors inoperable or improperly connection</li> </ul>	<ul style="list-style-type: none"> <li>Test for system leaks using leak test procedure</li> <li>Check refrigerant charge level; Adjust if needed</li> <li>Check TXV; Replace if needed</li> <li>Check the connection to thermistors; Repair/replace if needed</li> </ul>
B0	Eb0	NO ID AIRFLOW	The estimated airflow from indoor subsystem is near to 0 CFM.	<ul style="list-style-type: none"> <li>Failed indoor blower motor</li> <li>Indoor fan motor not properly connected</li> <li>Too much static pressure</li> </ul>	<ul style="list-style-type: none"> <li>Check ID fan motor wiring and connectors; Repair/replace if needed</li> <li>Check ID fan motor; Replace if needed</li> </ul>
B9	Eb9	LOW ID AIRFLOW	Estimated airflow from motor is lower than the airflow requirement.	<ul style="list-style-type: none"> <li>Failed indoor blower motor</li> <li>Indoor fan motor not properly connected</li> <li>Too much static pressure</li> </ul>	<ul style="list-style-type: none"> <li>Check ID fan motor wiring and connectors; Repair/replace if needed</li> <li>Check ID fan motor; Replace if needed</li> </ul>
D0	Ed0	NO NET DATA	Control board does not have the necessary data for it to properly perform its functions.	<ul style="list-style-type: none"> <li>Air conditioner is wired as part of a communicating system and integrated control module does not contain any shared data.</li> </ul>	<ul style="list-style-type: none"> <li>Replace control board if necessary</li> <li>Re-write shared data using Bluetooth® Shared Data Loader BTSDL01</li> </ul>
D1	Ed1	INVALID DATA	Control board does not the appropriate data needed to properly perform its functions.	<ul style="list-style-type: none"> <li>Air conditioner is wired as part of a communicating system and integrated control module contains invalid shared data or network data is invalid for the integrated control module.</li> </ul>	<ul style="list-style-type: none"> <li>Replace control board if necessary</li> <li>Re-write shared data using Bluetooth® Shared Data Loader BTSDL01</li> </ul>
D2	Ed2	INVALID SYSTEM	The airflow requirement is greater than the airflow capability of the indoor subsystem.	<ul style="list-style-type: none"> <li>Air conditioner/heat pump is wired as part of a communicating system and outdoor unit requires airflow greater than indoor unit's airflow capability</li> <li>Shared data is incompatible the system or missing parameters</li> <li>Communication wiring has loose connection.</li> </ul>	<ul style="list-style-type: none"> <li>Verify shared data is correct for your specific model; Repopulate data if required</li> <li>Check communication wiring. Repair as needed.</li> </ul>
D3	Ed3	INVALID CONFIG	There is a mismatch between the shared data and the control physical hardware.	<ul style="list-style-type: none"> <li>Shared data sent to integrated control module does not match hardware configuration.</li> </ul>	<ul style="list-style-type: none"> <li>Verify shared data is correct for your specific model; Repopulate data if required.</li> </ul>
D4	Ed4	INVALID MC DATA	The Bluetooth® Shared Data Loader BTSDL01 data has been rejected.	<ul style="list-style-type: none"> <li>Shared data on Bluetooth® Shared Data Loader BTSDL01 has been rejected.</li> </ul>	<ul style="list-style-type: none"> <li>Verify shared data is correct for your specific model; Repopulate data if required.</li> </ul>
<b>Items below are messages only displayed on the thermostat screen.</b>					
11	E11	RUN SYS TEST	This test is required at startup. Installer should navigate to the ComfortNet User Menu, choose Air Conditioner, then EQUIP TEST and SYSTEM TEST. Selecting ON will run the required test. Display will clear once testing is complete.	<ul style="list-style-type: none"> <li>Incomplete SYSTEM TEST</li> <li>SYSTEM TEST is running</li> </ul>	MESSAGE ONLY

# TROUBLESHOOTING

## RE-WRITING SHARED DATA TO OUTDOOR UNIT USING BLUETOOTH® SHARED DATA LOADER BTSDL01

Check Troubleshooting codes to determine the need to flash shared data to outdoor unit. Follow the below procedure to flash shared data.

Procedure to flash shared data to Outdoor unit using Bluetooth® Shared Data Loader BTSDL01

1. Turn the power OFF to the outdoor unit.
2. Disconnect the Climate Talk (CT) connector from the outdoor unit.
3. Insert the Bluetooth® Shared Data Loader BTSDL01 on the outdoor unit.
4. Turn the power ON to the outdoor unit.
5. Verify that H1P (red LED) flashes twice. This step confirms that the data has been transferred from the Bluetooth® Shared Data Loader BTSDL01 to the outdoor unit.
6. Turn the power OFF to the outdoor unit.
7. Remove the Bluetooth® Shared Data Loader BTSDL01 from the unit.

8. Connect the Climate Talk (CT) connector to the outdoor unit.
9. Turn the power ON to the outdoor unit.
10. Continue the operation of the unit as desired.

### NOTE:

1. If there is an error E11 on the 7-segment display of the Outdoor unit after step 11, run the System Verification Test on the Outdoor unit using the thermostat menu.
  - AC - Menu → Air Conditioner → Equip Test → System Verification Test → ON
  - HP - Menu → Air Conditioner → Equip Test → System Verification Test → ON
2. The control boards for different 19.2 SEER2 OD units (2T, 3T, 4T, 5T) are different. Below are the names of the connectors for quick identification.
  - Bluetooth® Shared Data Loader BTSDL01 connector - X52A (white - 12 pin connector)
  - Climate Talk connector - X851A (green - 9 pin connector)
  - Red LED - H1P



IDENTIFICATION OF CONNECTORS ON 19.2 SEER2 OD CONTROL BOARD

# TROUBLESHOOTING



ZOOMED VIEW OF 19.2 SEER2 OD CONTROL BOARD

# TROUBLESHOOTING

## NETWORK TROUBLESHOOTING

If a network communication error code has occurred, use the following steps to help troubleshoot the system. (For network communication error codes, refer to the table below and the tables of error codes for outdoor unit and indoor unit.)

After any wiring changes have been made or DS1 dip switches on the outdoor unit control board have been changed, apply power to the system and see if the error codes have cleared.

1. Confirm low voltage wiring is correct per installation instructions. Check for miswiring. (i.e. Terminal 1 and 2 is reversed.)

**NOTE:** A removable plug connector is provided with the control to make thermostat wire connections. This plug may be removed, wire connections made to the plug, and replaced. It is strongly recommended that you do not connect more than two wires into a single terminal in the field because there is a risk of the wires becoming loose, which may result in intermittent operation.

2. Check wires for damage. (i.e. Broken wire at terminal, broken inside wire nuts or damaged cable between units.)

3. Perform continuity check on wires to make sure cable is OK. Replace the cable if necessary.
4. Change both dip switches of DS1 on the outdoor unit control board to the opposite position. See image above.

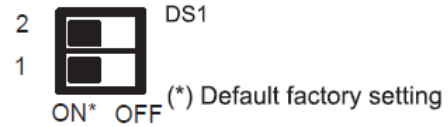

The integrated control module has some onboard tools that can be used to troubleshoot the network. These tools are: red communications LED, green receive (Rx) LED, and the learn button.

- Red communications LED – Indicates the status of the network. The table below indicates the LED status and the corresponding potential problem.
- Green receive LED – Indicates network traffic. The table below indicates the LED status and the corresponding potential problem.
- LEARN button – Used to reset the network. Press the button for approximately 5 seconds to reset the network.

LED COLOR	LED Status	Indication	Probable Causes	Corrective Actions
Red Communications LED Outdoor unit control board:(H1P) Indoor unit control board :(H2P)	Off	Normal condition	• None	• None
	1 Flash	Communications failure	• Unknown packet is received • Communications failure	• Depress learn button • Verify wiring connection
	2 Flash	Out-of-box reset	• Control power up • Learn button depressed	• None
Green Receive LED Outdoor unit control board:(H2P) Indoor unit control board:(H3P)	Off	No power Communications error	• No power to unit • Open fuse • Communication error	• Check circuit breakers and fuses; Reset/Replace if needed • Reset network by depressing learn button • Check communication wires (terminal 1/terminal 2 wires); Replace if needed • Check for shorts in low voltage wiring.
	1 Steady Flash	No network found	• Broken/disconnected communication wire(s) • Unit is installed as a legacy/traditional system	• Check communication wires (terminal 1/terminal 2 wires); Replace if needed • Check installation type (legacy/traditional or communicating)
	Rapid Flashing	Normal network traffic	• Control is “talking” on network as expected	• None
	On Solid	Terminal 1/Terminal 2 miss-wire	• Terminal 1 and Terminal 2 wires reversed at indoor unit, thermostat, or outdoor unit • Short between terminal 1 and terminal 2 wires • Short between terminal 1 or terminal 2 two wires and terminal C (24VAC) or terminal R (24VAC, COM)	• Check communication wires (terminal 1/terminal 2 wires); Replace if needed

# TROUBLESHOOTING

# THERMISTOR RESISTANCE VALUE

		Tm : Coil Tl : Liquid Tb : Defrost Tgi: Indoor Gas Tli: Indoor Liquid		Tl : Liquid		Td : Discharge		Ta : Ambient	
TEMP	TEMP	Thermistor Resistance	Volts	Thermistor Resistance	Volts	Thermistor Resistance	Volts	Thermistor Resistance	Volts
(°C)	(F)	R (kΩ)	DC (V)	R (kΩ)	DC (V)	R (kΩ)	DC (V)	R (kΩ)	DC (V)
-30	-22	364.43	4.58	364.43	4.58	4759.15	4.96	362.48	4.58
-25	-13	267.00	4.45	267.00	4.45	3454.24	4.94	265.99	4.45
-20	-4	197.81	4.29	197.81	4.29	2533.62	4.92	197.31	4.28
-15	5	148.10	4.09	148.10	4.09	1877.01	4.90	147.86	4.09
-10	14	111.99	3.86	111.99	3.86	1403.82	4.86	111.88	3.86
-5	23	85.49	3.61	85.49	3.61	1059.45	4.82	85.43	3.61
0	32	65.84	3.33	65.84	3.33	806.47	4.77	65.80	3.33
5	41	51.09	3.04	51.09	3.04	618.95	4.70	51.10	3.04
10	50	39.96	2.74	39.96	2.74	478.76	4.62	39.99	2.74
15	59	31.50	2.44	31.50	2.44	373.11	4.53	31.54	2.44
20	68	25.01	2.16	25.01	2.16	292.86	4.41	25.06	2.16
25	77	20.00	1.89	20.00	1.89	231.44	4.28	20.04	1.89
30	86	16.10	1.64	16.10	1.64	184.11	4.13	16.13	1.64
35	95	13.04	1.42	13.04	1.42	147.37	3.95	13.07	1.42
40	104	10.63	1.22	10.63	1.22	118.68	3.76	10.65	1.22
45	113	8.71	1.04	8.71	1.04	96.13	3.56	8.73	1.05
50	122	7.18	0.89	7.18	0.89	78.29	3.34	7.18	0.89
55	131	5.95	0.76	5.95	0.76	64.10	3.11	-	-
60	140	4.96	0.65	4.96	0.65	52.76	2.87	-	-
65	149	4.16	0.56	4.16	0.56	43.63	2.64	-	-
70	158	3.50	0.48	3.50	0.48	36.26	2.41	-	-
75	167	2.96	0.41	2.96	0.41	30.27	2.18	-	-
80	176	2.51	0.35	2.51	0.35	25.38	1.97	-	-
85	185	2.14	0.30	2.14	0.30	21.37	1.77	-	-
90	194	1.83	0.26	1.83	0.26	18.06	1.58	-	-
95	203	1.58	0.23	1.58	0.23	15.33	1.41	-	-
100	212	1.36	0.20	1.36	0.20	13.06	1.25	-	-
105	221	1.18	0.17	1.18	0.17	11.17	1.11	-	-
110	230	1.02	0.15	1.02	0.15	9.59	0.99	-	-
115	239	0.89	0.13	0.89	0.13	8.25	0.87	-	-
120	248	0.78	0.12	0.78	0.12	7.13	0.77	-	-
125	257	0.68	0.10	0.68	0.10	6.18	0.68	-	-
130	266	0.60	0.09	0.60	0.09	5.37	0.61	-	-
135	275	0.53	0.08	0.53	0.08	4.69	0.54	-	-
140	284	0.47	0.07	0.47	0.07	4.10	0.48	-	-
145	293	0.42	0.06	0.42	0.06	3.59	0.42	-	-
150	302	0.37	0.06	0.37	0.06	3.16	0.37	-	-





<b>R-410A Pressure vs. Temperature Chart</b>											
PSIG	°F	PSIG	°F	PSIG	°F	PSIG	°F	PSIG	°F	PSIG	°F
12	-37.7	114	37.8	216	74.3	318	100.2	420.0	120.7	522	137.6
14	-34.7	116	38.7	218	74.9	320	100.7	422.0	121.0	524	137.9
16	-32.0	118	39.5	220	75.5	322	101.1	424.0	121.4	526	138.3
18	-29.4	120	40.5	222	76.1	324	101.6	426.0	121.7	528	138.6
20	-36.9	122	41.3	224	76.7	326	102.0	428.0	122.1	530	138.9
22	-24.5	124	42.2	226	77.2	328	102.4	430.0	122.5	532	139.2
24	-22.2	126	43.0	228	77.8	330	102.9	432.0	122.8	534	139.5
26	-20.0	128	43.8	230	78.4	332	103.3	434.0	123.2	536	139.8
28	-17.9	130	44.7	232	78.9	334	103.7	436.0	123.5	538	140.1
30	-15.8	132	45.5	234	79.5	336	104.2	438.0	123.9	540	140.4
32	-13.8	134	46.3	236	80.0	338	104.6	440.0	124.2	544	141.0
34	-11.9	136	47.1	238	80.6	340	105.1	442.0	124.6	548	141.6
36	-10.1	138	47.9	240	81.1	342	105.4	444.0	124.9	552	142.1
38	-8.3	140	48.7	242	81.6	344	105.8	446.0	125.3	556	142.7
40	-6.5	142	49.5	244	82.2	346	106.3	448.0	125.6	560	143.3
42	-4.5	144	50.3	246	82.7	348	106.6	450.0	126.0	564	143.9
44	-3.2	146	51.1	248	83.3	350	107.1	452.0	126.3	568	144.5
46	-1.6	148	51.8	250	83.8	352	107.5	454.0	126.6	572	145.0
48	0.0	150	52.5	252	84.3	354	107.9	456.0	127.0	576	145.6
50	1.5	152	53.3	254	84.8	356	108.3	458.0	127.3	580	146.2
52	3.0	154	54.0	256	85.4	358	108.8	460.0	127.7	584	146.7
54	4.5	156	54.8	258	85.9	360	109.2	462.0	128.0	588	147.3
56	5.9	158	55.5	260	86.4	362	109.6	464.0	128.3	592	147.9
58	7.3	160	56.2	262	86.9	364	110.0	466.0	128.7	596	148.4
60	8.6	162	57.0	264	87.4	366	110.4	468.0	129.0	600	149.0
62	10.0	164	57.7	266	87.9	368	110.8	470.0	129.3	604	149.5
64	11.3	166	58.4	268	88.4	370	111.2	472.0	129.7	608	150.1
66	12.6	168	59.0	270	88.9	372	111.6	474.0	130.0	612	150.6
68	13.8	170	59.8	272	89.4	374	112.0	476.0	130.3	616	151.2
70	15.1	172	60.5	274	89.9	376	112.4	478.0	130.7	620	151.7
72	16.3	174	61.1	276	90.4	378	112.6	480.0	131.0	624	152.3
74	17.5	176	61.8	278	90.9	380	113.1	482.0	131.3	628	152.8
76	18.7	178	62.5	280	91.4	382	113.5	484.0	131.6	632	153.4
78	19.8	180	63.1	282	91.9	384	113.9	486.0	132.0	636	153.9
80	21.0	182	63.8	284	92.4	386	114.3	488.0	132.3	640	154.5
82	22.1	184	64.5	286	92.8	388	114.7	490.0	132.6	644	155.0
84	23.2	186	65.1	288	93.3	390	115.0	492.0	132.9	648	155.5
86	24.3	188	65.8	290	93.8	392	115.5	494.0	133.3	652	156.1
88	25.4	190	66.4	292	94.3	394	115.8	496.0	133.6	656	156.6
90	26.4	192	67.0	294	94.8	396	116.2	498.0	133.9	660	157.1
92	27.4	194	67.7	296	95.2	398	116.6	500.0	134.0	664	157.7
94	28.5	196	68.3	298	95.7	400	117.0	502.0	134.5	668	158.2
96	29.5	198	68.9	300	96.2	402	117.3	504.0	134.8	672	158.7
98	30.5	200	69.5	302	96.6	404	117.7	506.0	135.2	676	159.2
100	31.2	202	70.1	304	97.1	406	118.1	508.0	135.5	680	159.8
102	32.2	204	70.7	306	97.5	408	118.5	510.0	135.8	684	160.3
104	33.2	206	71.4	308	98.0	410	118.8	512.0	136.1	688	160.8
106	34.1	208	72.0	310	98.4	412	119.2	514.0	136.4	692	161.3
108	35.1	210	72.6	312	98.9	414	119.6	516.0	136.7	696	161.8
110	35.5	212	73.2	314	99.3	416	119.9	518.0	137.0		
112	36.9	214	73.8	316	99.7	418	120.3	520.0	137.3		

# TROUBLESHOOTING

Required Liquid Line Temperature						
LIQUID PRESSURE AT SERVICE VALVE (PSIG)	REQUIRED SUBCOOLING TEMPERATURE (°F)					
	8	10	12	14	16	18
189	58	56	54	52	50	48
195	60	58	56	54	52	50
202	62	60	58	56	54	52
208	64	62	60	58	56	54
215	66	64	62	60	58	56
222	68	66	64	62	60	58
229	70	68	66	64	62	60
236	72	70	68	66	64	62
243	74	72	70	68	66	64
251	76	74	72	70	68	66
259	78	76	74	72	70	68
266	80	78	76	74	72	70
274	82	80	78	76	74	72
283	84	82	80	78	76	74
291	86	84	82	80	78	76
299	88	86	84	82	80	78
308	90	88	86	84	82	80
317	92	90	88	86	84	82
326	94	92	90	88	86	84
335	96	94	92	90	88	86
345	98	96	94	92	90	88
354	100	98	96	94	92	90
364	102	100	98	96	94	92
374	104	102	100	98	96	94
384	106	104	102	100	98	96
395	108	106	104	102	100	98
406	110	108	106	104	102	100
416	112	110	108	106	104	102
427	114	112	110	108	106	104
439	116	114	112	110	108	106
450	118	116	114	112	110	108
462	120	118	116	114	112	110
474	122	120	118	116	114	112
486	124	122	120	118	116	114
499	126	124	122	120	118	116
511	128	126	124	122	120	118

# TROUBLESHOOTING

 <b>WARNING</b>	
<p><b>HIGH VOLTAGE</b>          DISCONNECT ALL POWER BEFORE SERVICING.          MULTIPLE POWER SOURCES MAY BE PRESENT. FAILURE TO DO SO MAY CAUSE PROPERTY DAMAGE, PERSONAL INJURY OR DEATH.</p>	
 <b>CAUTION</b>	
<p>WHEN REPLACING THE ELECTRICAL BOARD, DO NOT TOUCH THE HATCHED AREAS. BEFORE INSTALLING THE NEW ELECTRICAL BOARD, BE SURE TO WIPE THE GREASE OFF THE REFRIGERANT TUBING. EXERCISE CAUTION TO NOT DAMAGE THE ELECTRICAL CONNECTIONS. DISCONNECT AS NEEDED.</p>	

## UNINSTALL THE ELECTRICAL BOARD

When uninstalling the main electrical board, remove the screws holding the cover in place. If board replacement is attempted without following proper uninstallation procedure, the refrigerant piping might be damaged. Always replace the grease with new grease on heat sink used for cooling. Not replacing grease may result in insufficient cooling and may damage the electrical board.

1. Remove the fixing screw A.

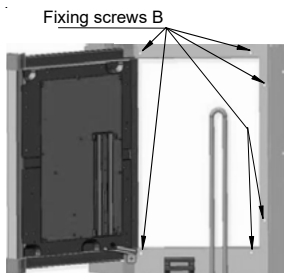
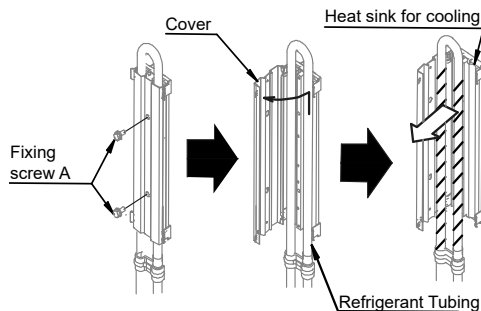

2. Lift the cover and open it in the direction shown in the figure.
3. Remove fixing screws B affixing the sheet metal plate.
4. Carefully slide the sheet metal plate with the electrical board behind the refrigerant tubing as shown.

## INSTALL THE ELECTRICAL BOARD

When working on a service port, ensure that no refrigerant and/or compressor oil is sprayed onto the electrical board. This could damage the board's functionality.

1. Wipe the stale grease completely from the installed piping. If you reinstall the control board, make sure to wipe clean the heat sink on the board. Coat the surface with the standard quantity of the specified new grease.
2. Carefully slide the sheet metal plate back in and fix the screws B.
3. Do not apply force to the parts on the control board. Hold the control board plate NOT the control board.
4. Ensure that the liquid tube does not come in contact with any part of the PCB assembly.
5. Gently fit the tube in the heat sink troughs. Ensure good contact.
6. Close the cover, slide it downwards, fix it with the nails (two nails) and tighten fixing screws A so that the piping is tightly connected.

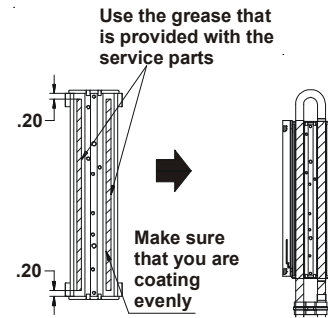

Tighten torque:  
 $14.1 \pm 1.7$  lbf-in

Tighten with a driver until the position where a tightening torque increases suddenly. Then extra-tighten by  $30^\circ$  to  $40^\circ$

# TROUBLESHOOTING

## WARNING

AVOID CONTACT WITH THE CHARGED AREA.

• NEVER TOUCH THE CHARGED AREA BEFORE CONFIRMING THAT THE RESIDUAL VOLTAGE IS 50 VOLTS OR LESS.

1. SHUT DOWN THE POWER AND LEAVE THE CONTROL BOX FOR 10 MINUTES.
2. MAKE SURE TO TOUCH THE EARTH GROUND TERMINAL TO RELEASE THE STATIC ELECTRICITY FROM YOUR BODY (TO PREVENT FAILURE OF THE PC BOARD).
3. MEASURE THE RESIDUAL VOLTAGE IN THE SPECIFIED MEASUREMENT POSITION USING A VOM WHILE PAYING ATTENTION NOT TO TOUCH THE CHARGED AREA.
4. IMMEDIATELY AFTER MEASURING THE RESIDUAL VOLTAGE, DISCONNECT THE CONNECTORS OF THE OUTDOOR UNIT'S FAN MOTOR. (IF THE FAN BLADE ROTATES BY STRONG WIND BLOWING AGAINST IT, THE CAPACITOR WILL BE CHARGED, CAUSING THE DANGER OF ELECTRICAL SHOCK.)

\*SXV902410\*\*

\*SXV903610\*\*

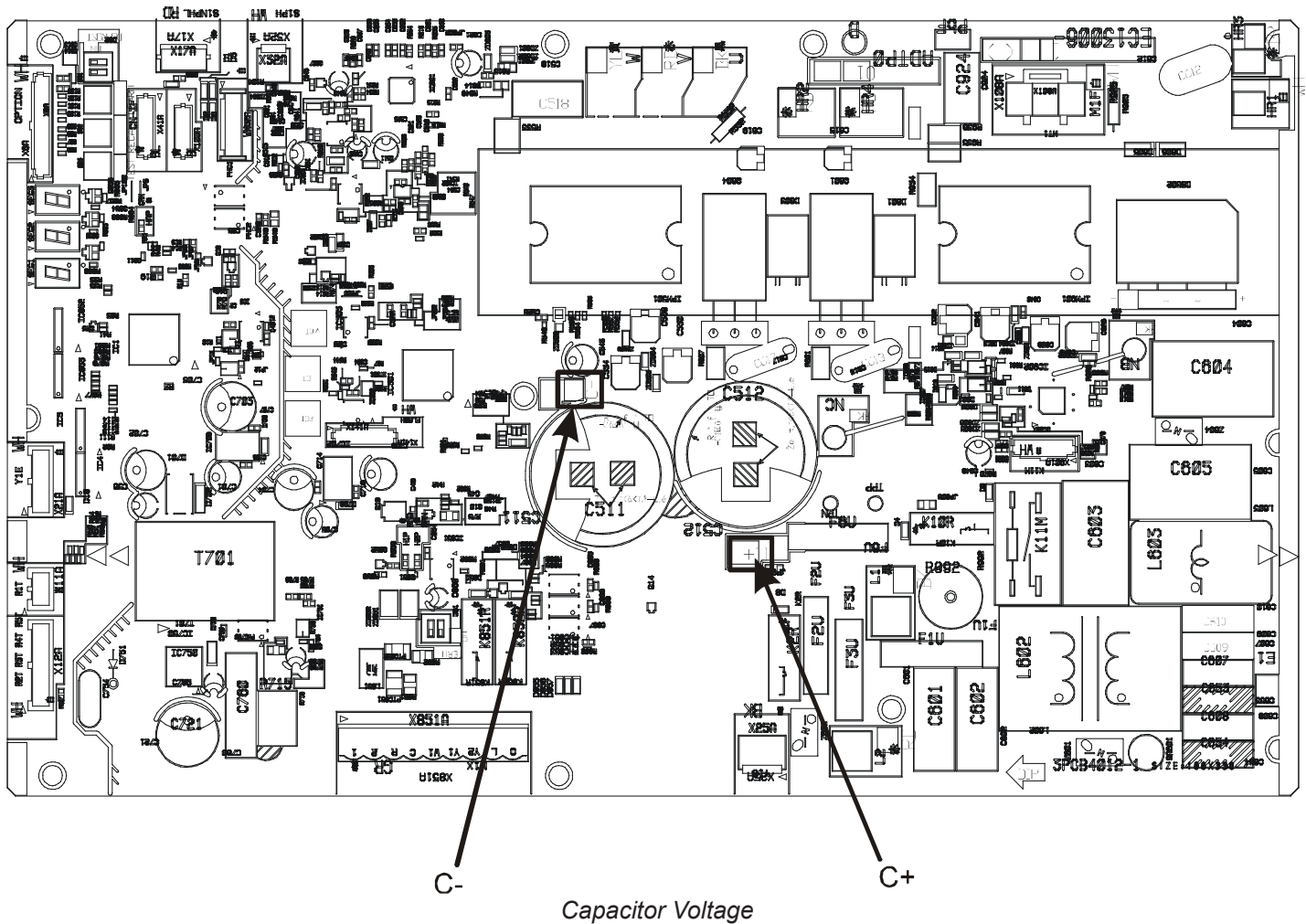



# TROUBLESHOOTING

## WARNING

AVOID CONTACT WITH THE CHARGED AREA.

• NEVER TOUCH THE CHARGED AREA BEFORE CONFIRMING THAT THE RESIDUAL VOLTAGE IS 50 VOLTS OR LESS.

1. SHUT DOWN THE POWER AND LEAVE THE CONTROL BOX FOR 10 MINUTES.
2. MAKE SURE TO TOUCH THE EARTH GROUND TERMINAL TO RELEASE THE STATIC ELECTRICITY FROM YOUR BODY (TO PREVENT FAILURE OF THE PC BOARD).
3. MEASURE THE RESIDUAL VOLTAGE IN THE SPECIFIED MEASUREMENT POSITION USING A VOM WHILE PAYING ATTENTION NOT TO TOUCH THE CHARGED AREA.
4. IMMEDIATELY AFTER MEASURING THE RESIDUAL VOLTAGE, DISCONNECT THE CONNECTORS OF THE OUTDOOR UNIT'S FAN MOTOR. (IF THE FAN BLADE ROTATES BY STRONG WIND BLOWING AGAINST IT, THE CAPACITOR WILL BE CHARGED, CAUSING THE DANGER OF ELECTRICAL SHOCK.)

**\*SXV906010\*\***

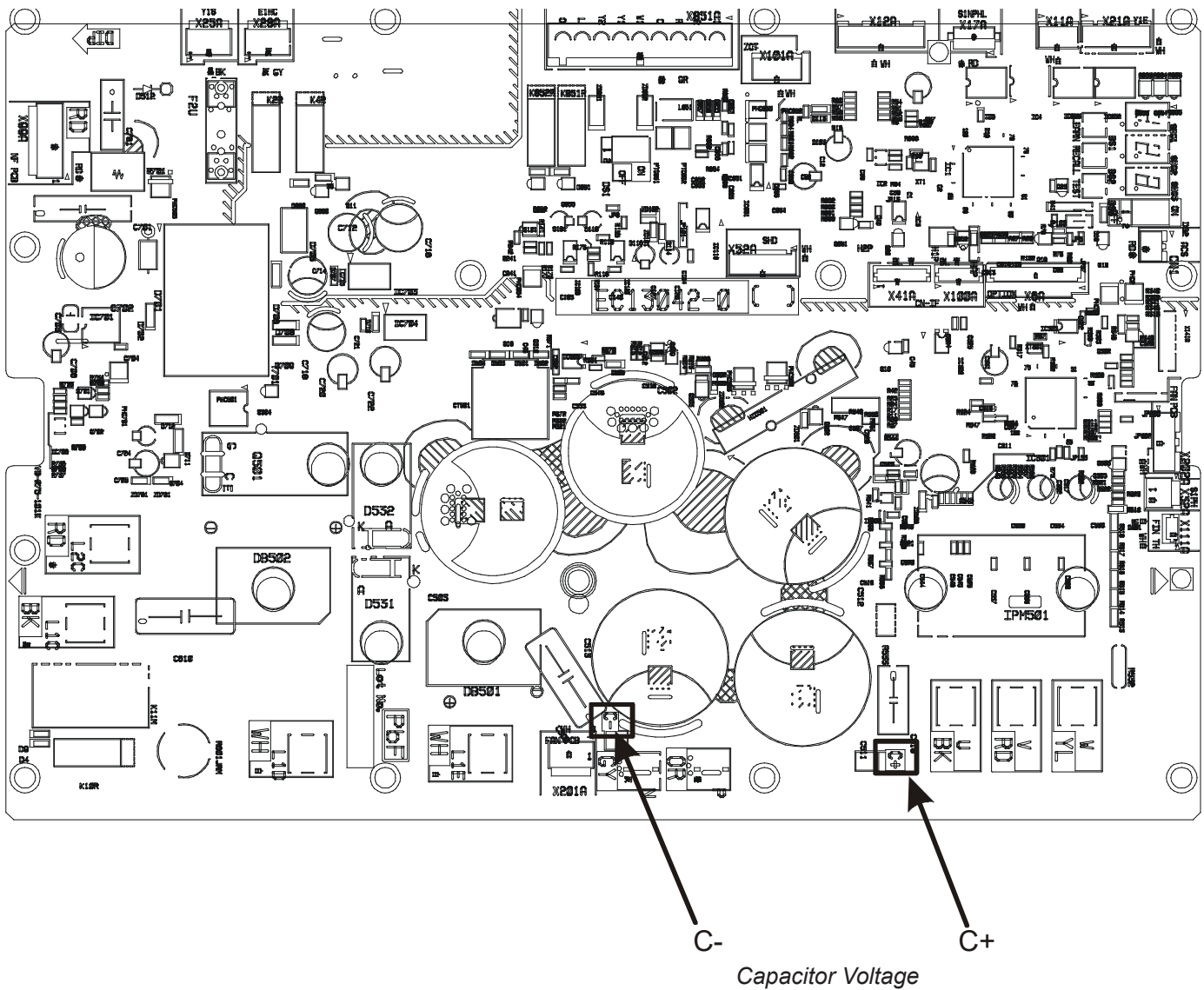

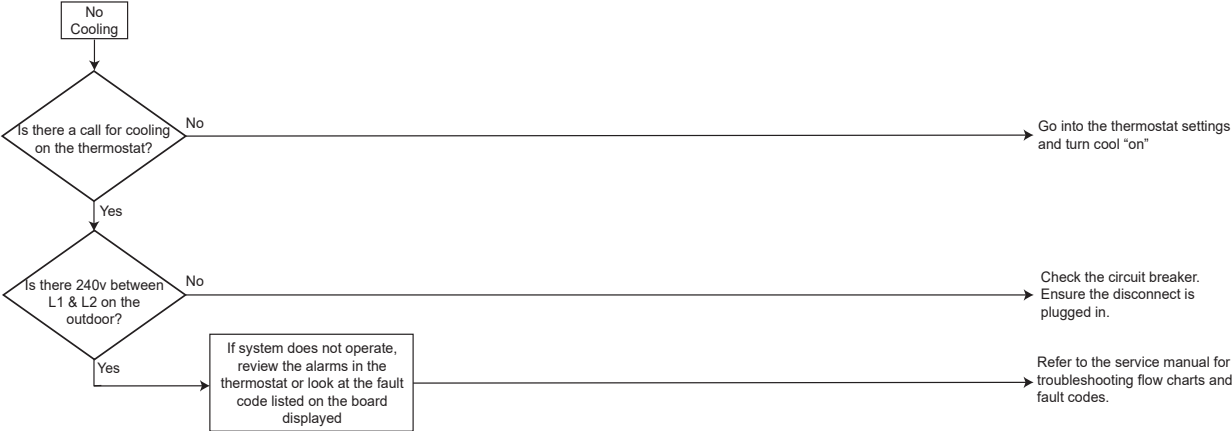

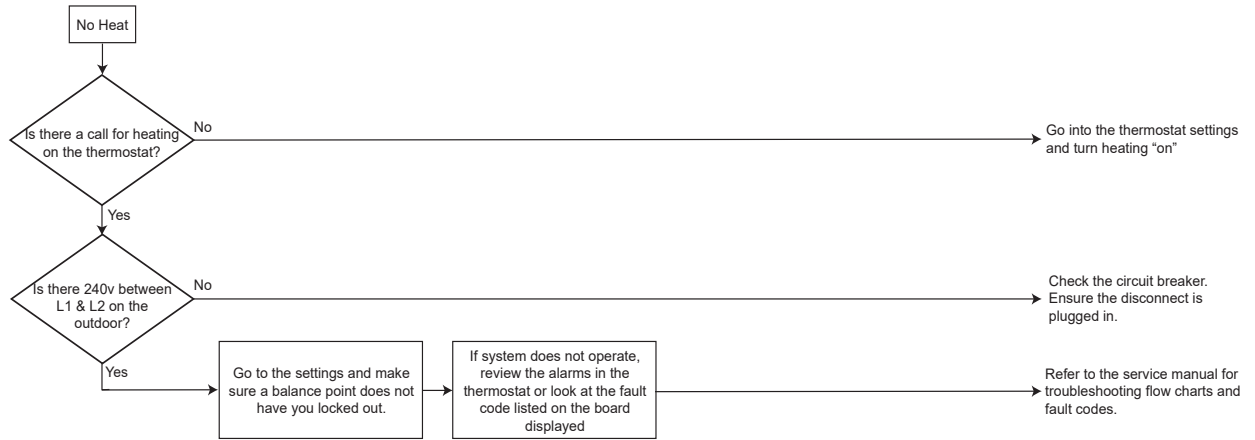



# Troubleshooting

# Error Code - 13

**Error Code:**  
13 - High pressure error critical

**Applicable Models:**  
Outdoor units

**Method of Error Detection:**  
(Cooling) OD hex mid thermistor  
(Heating) ID pressure sensor

**Error Decision Conditions:**  
When the pressure is higher than  
4.2 MPa (605 PSIG)



# Troubleshooting

# Error Code - 14

**Error Code:**  
14 - High pressure error minor

**Applicable Models:**  
Outdoor AC  
Outdoor HP

**Method of Error Detection:**  
(Cooling) OD hex mid thermistor  
(Heating) ID pressure sensor

**Error Decision Conditions:**  
When the pressure is higher than 4.2 MPa (605 PSIG)

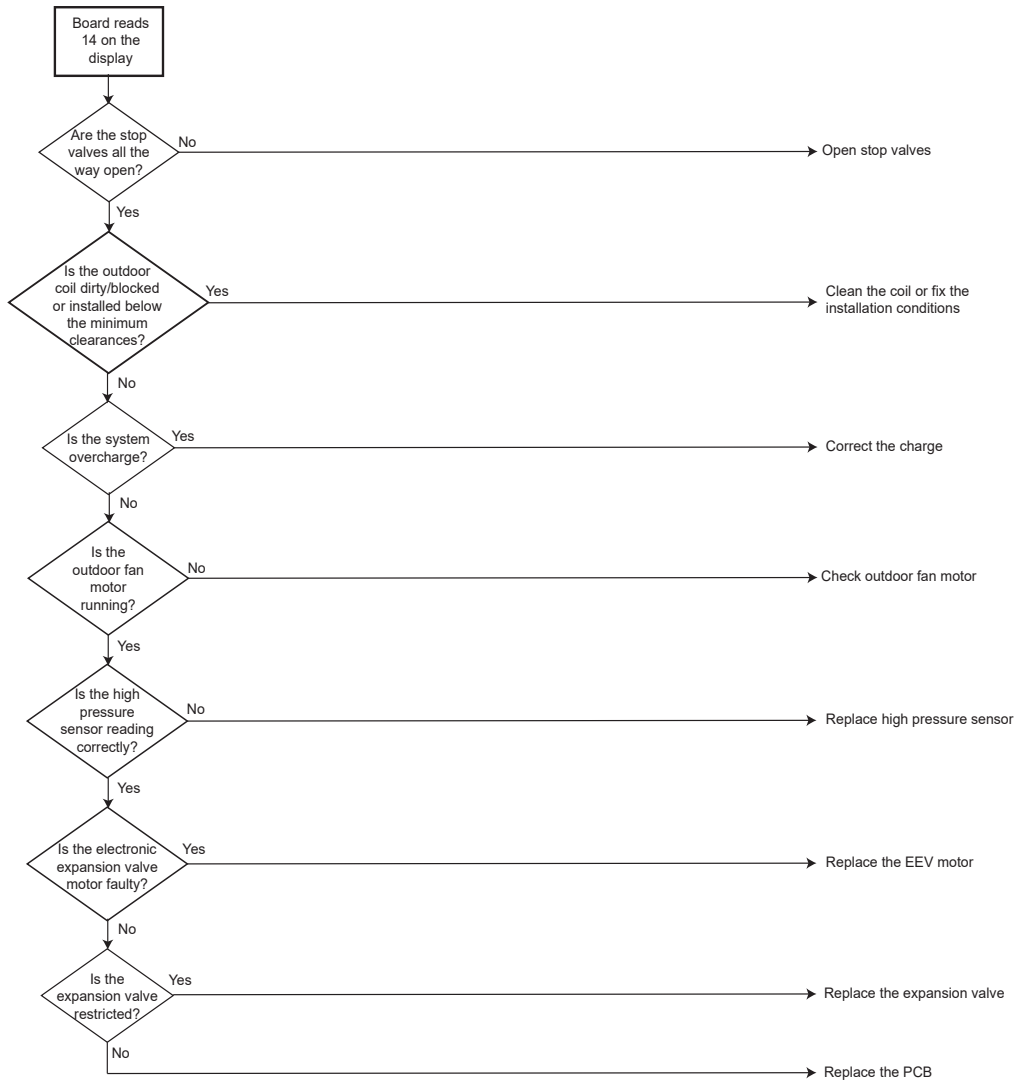

# Troubleshooting

# Error Code - 15 & 16

**Error Code:**  
 15 - Low pressure error  
 16 - Low pressure error (Minor)

**Applicable Models:**  
 Outdoor AC  
 Outdoor HP

**Method of Error Detection:**  
 (Cooling) ID or OD pressure sensor  
 (Heating) OD pressure sensor

**Error Decision Conditions:**  
 When it detect less pressure than criteria for 5 minutes.  
 (All Others.)  
 [Cooling] 0.12Mpa (17psi)  
 [Heating] 0.12Mpa (17psi)  
  
 (5T AC)  
 [Cooling] 0.59Mpa (85psi)  
 [Heating] 0.12Mpa (17psi)

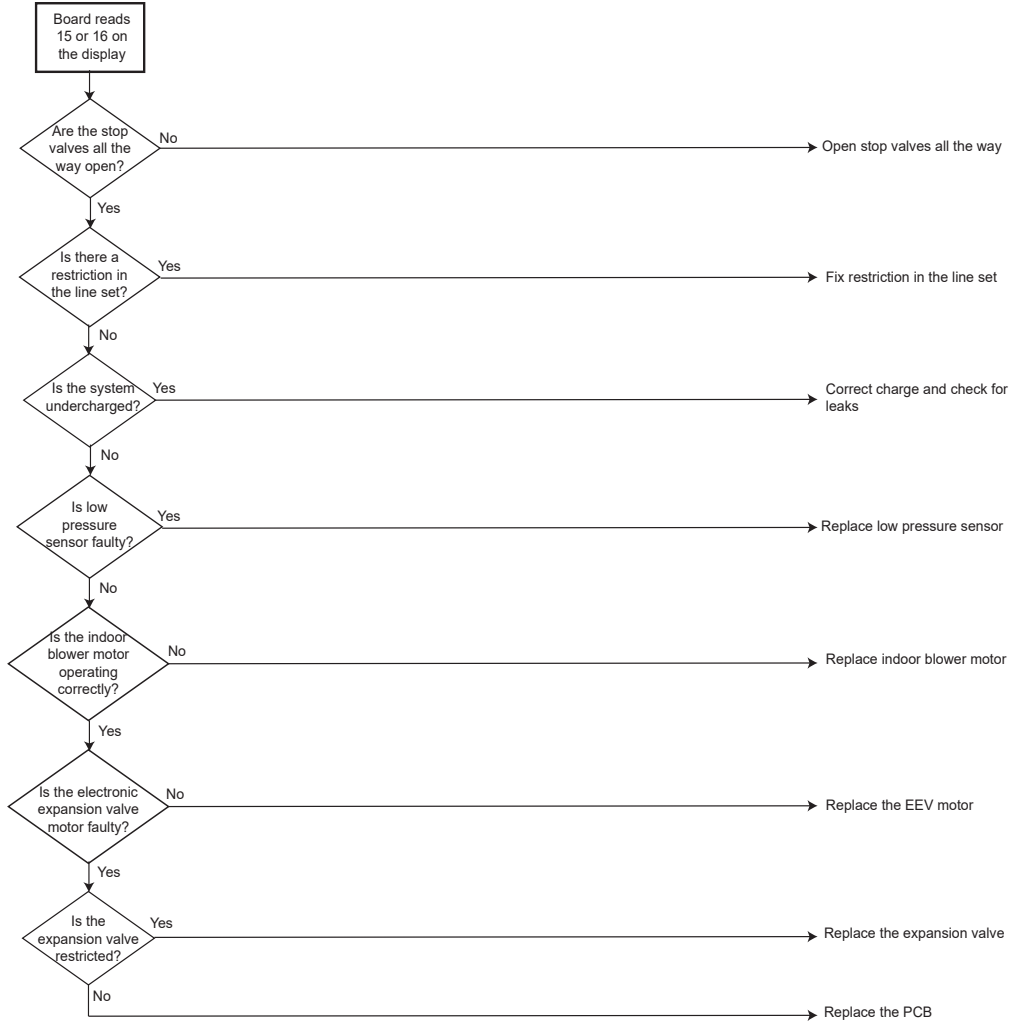

# Troubleshooting

# Error Code - 18 & 19

**Error Code:**  
18 - OD CTRL Fail 2  
19 - PCB or Fan Fail

**Applicable Models:**  
Outdoor AC  
Outdoor HP

**Method of Error Detection:**  
Disruption in the board communications/ overheating

**Error Decision Conditions:**  
Disruption in the board communications/ overheating



# Troubleshooting

# Error Code - 20

**Error Code:**  
20 - EEV open circuit

**Applicable Models:**  
Outdoor HP

**Method of Error Detection:**  
EEV coil is not connected

**Error Decision Conditions:**  
EEV coil is not connected

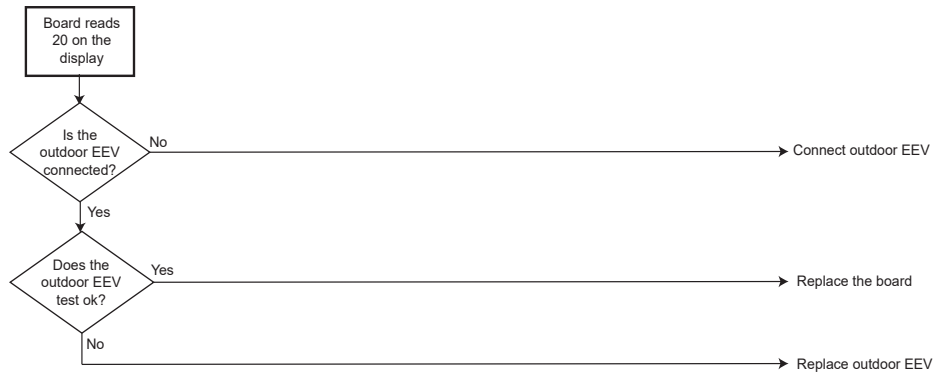

# Troubleshooting

# Error Code - 21

**Error Code:**  
21 - EEV control error

**Applicable Models:**  
Outdoor AC  
Outdoor HP

**Method of Error Detection:**  
Detected by discharge pipe superheat and EEV pulse.

**Error Decision Conditions:**  
When discharge pipe superheat became excessive low and EEV pulse is minimum.

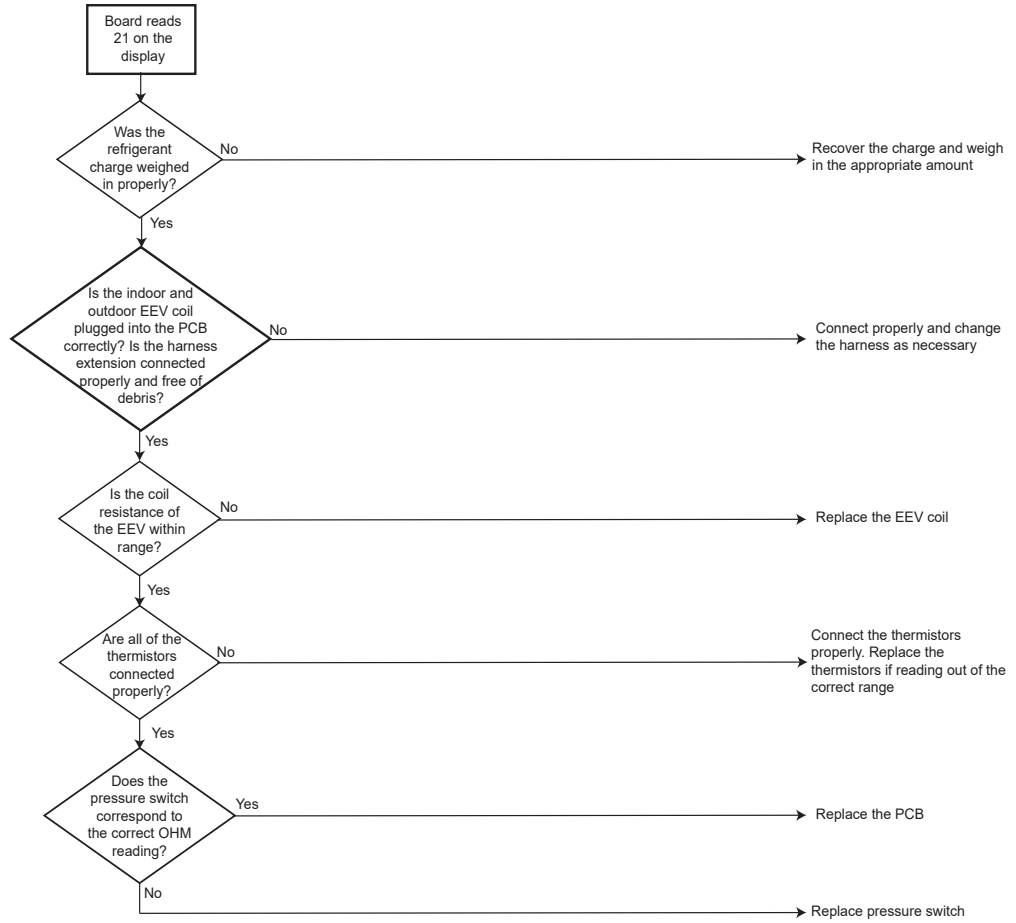

**Error Code:**  
22 - High discharge temperature error

**Applicable Models:**  
Outdoor AC  
Outdoor HP

**Method of Error Detection:**  
Detected by discharge temperature

**Error Decision Conditions:**  
When discharge temperature became excessive high

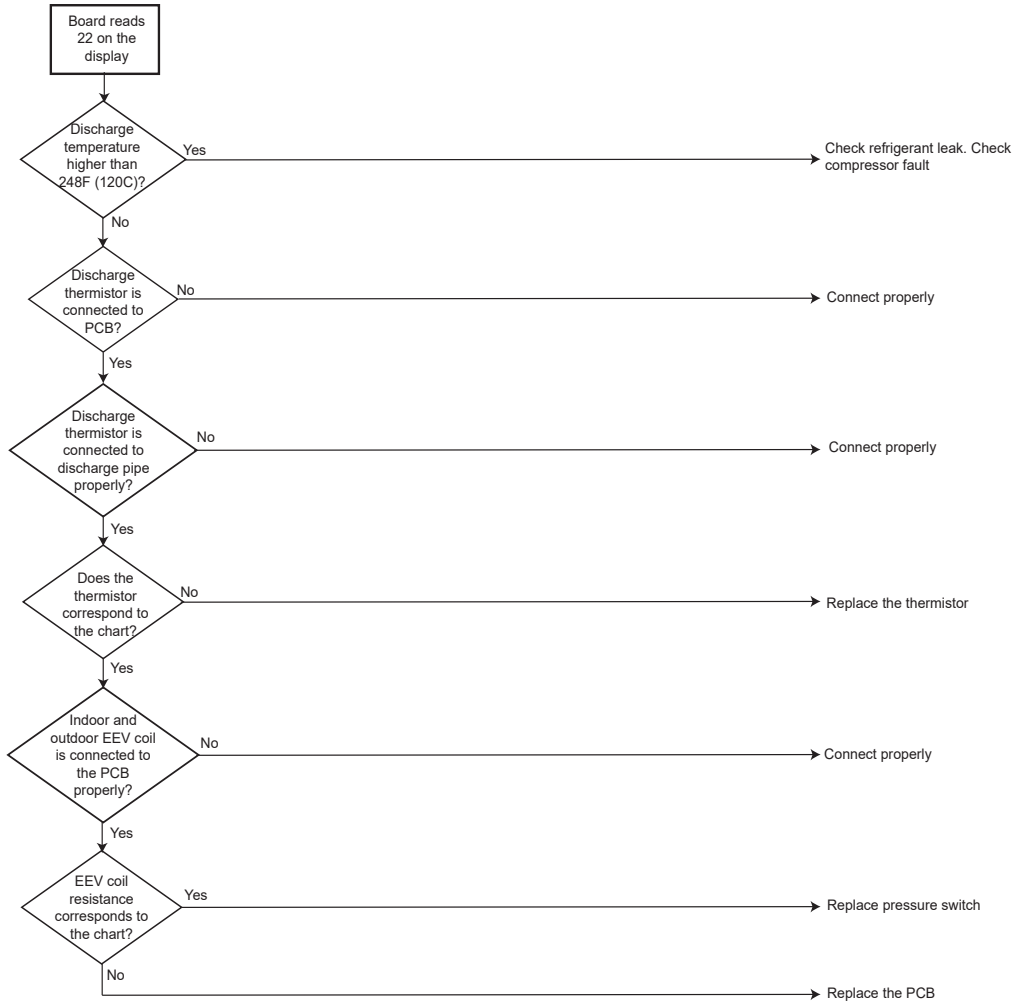

# Troubleshooting

# Error Code 23, 25, 27, 28, 29

**Error Code:**  
 23 - DISCH temperature fail  
 25 - Air sensor fault  
 27 - Coil temperature fail 1  
 28 - Coil temperature fail 2  
 29 - Liquid temperatre fail

**Applicable Models:**  
 Outdoor AC  
 Outdoor HP

**Method of Error Detection:**  
 23 - Detected by discharge temperature sensor  
 25 - Detected by air temperature sensor  
 27 - Detected by defrost sensor  
 28 - Detected by outdoor coil temperature sensor  
 29 - Detected by liquid temperature sensor

**Error Decision Conditions:**  
 23 - Discharge temperature sensor is out of range  
 25 - Outdoor air temperature sensor is open or shorted  
 27 - Outdoor defrost sensor is out of range  
 28 - Outdoor coil temperature is out of range  
 29 - Liquid temperature sensor is out of range

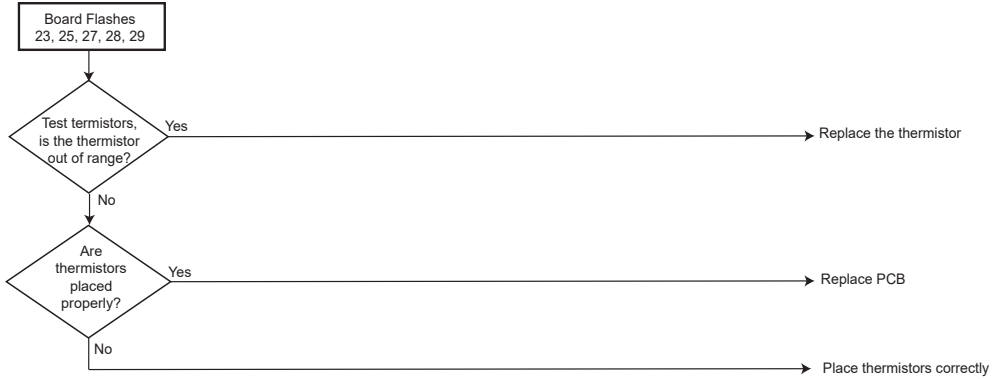



**Error Code:**  
24 - HPS open

**Applicable Models:**  
Outdoor AC  
Outdoor HP

**Method of Error Detection:**  
High pressure switch is open

**Error Decision Conditions:**  
High pressure switch is open

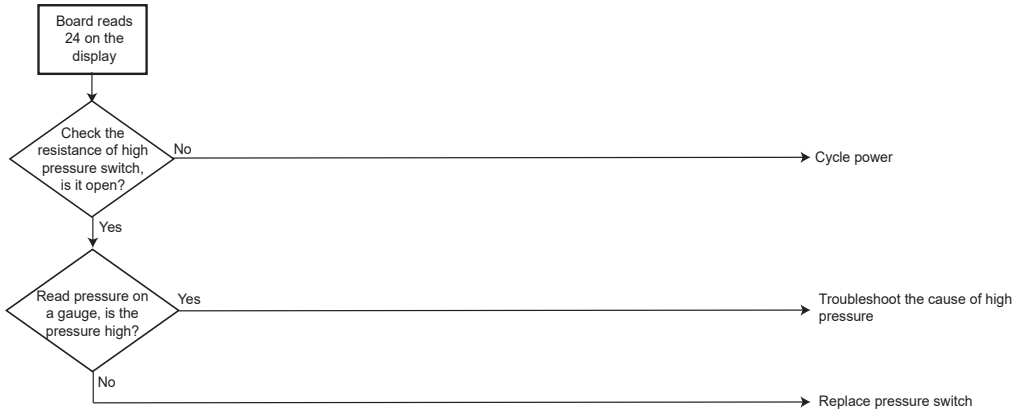

# Troubleshooting

# Error Code - 26

**Error Code:**  
26 - Pressure sensor

**Applicable Models:**  
Outdoor AC  
Outdoor HP

**Method of Error Detection:**  
Detected by pressure sensor

**Error Decision Conditions:**  
The control determines that the pressure sensor is not reacting properly

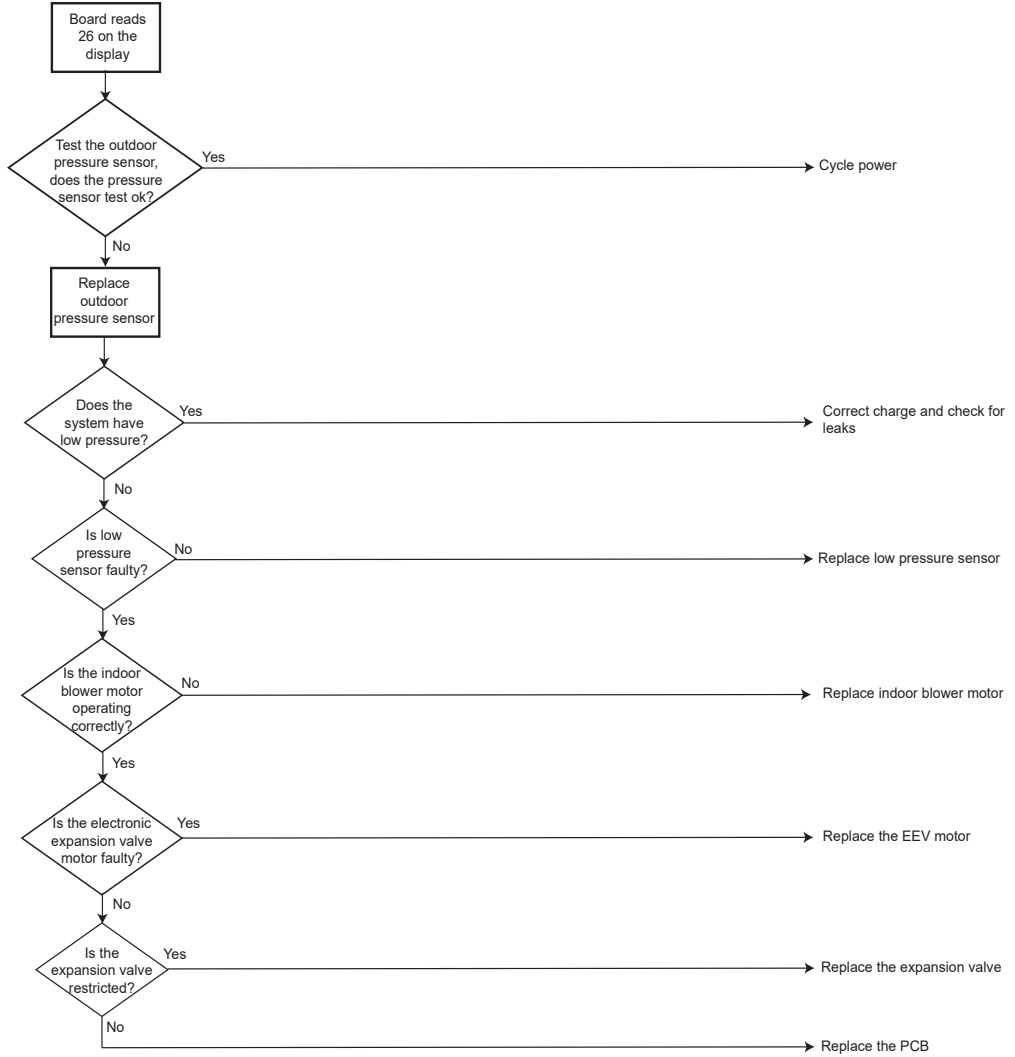

**Error Code:**  
30 - OD CTRL fail 3

**Applicable Models:**  
Outdoor AC  
Outdoor HP

**Method of Error Detection:**  
Control board

**Error Decision Conditions:**  
Indicates the control board may need to be replaced

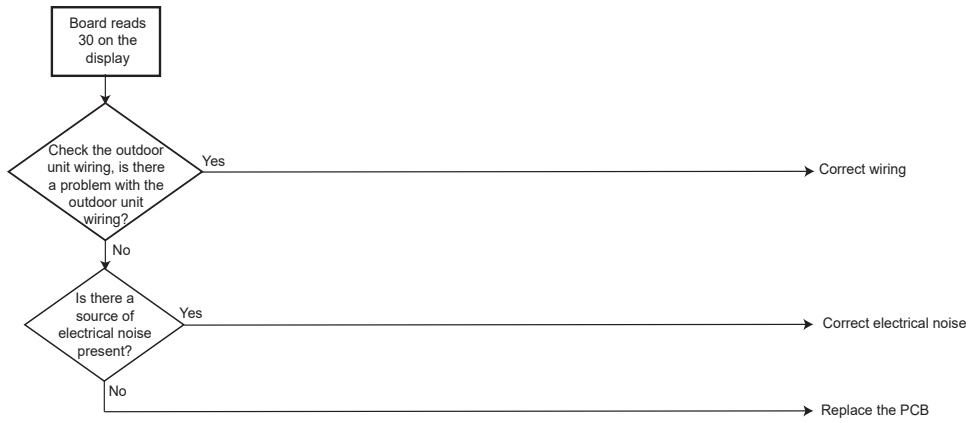

**Error Code:**  
31 - HI leak current

**Applicable Models:**  
Outdoor AC  
Outdoor HP

**Method of Error Detection:**  
Detected by continuity of OL switch.

**Error Decision Conditions:**  
The control has detected high leakage current (high voltage)

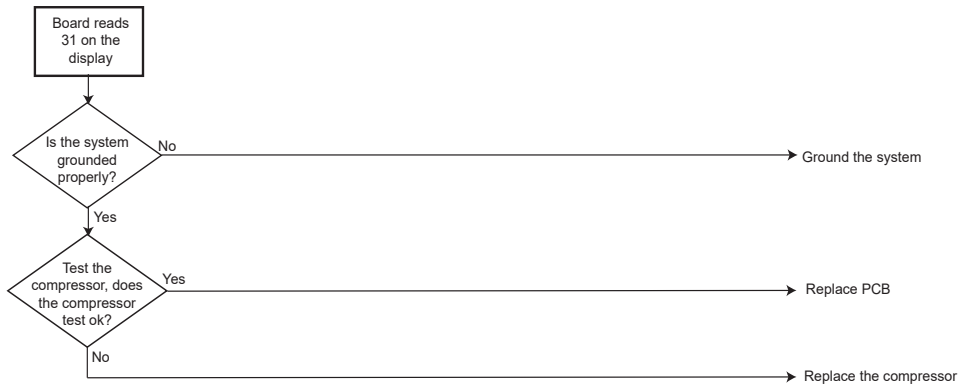

# Troubleshooting

# Error Code - 32 with cooling loop

**Error Code:**  
32 - Outdoor PCB high temperature error

**Applicable Models:**  
Outdoor AC 1.5-3.0 ton  
Outdoor HP 1.5-30. ton

**Method of Error Detection:**  
Detected by thermistor on inverter cooling fin

**Error Decision Conditions:**  
When the temperature became excessive high

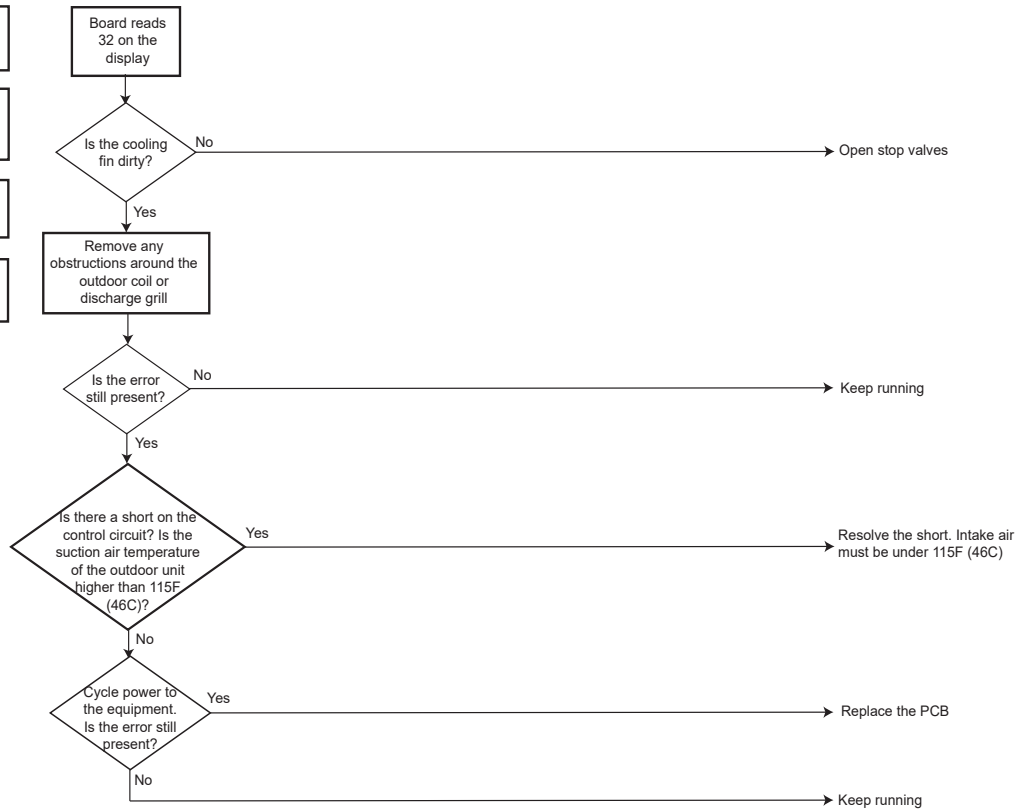

# Troubleshooting

# Error Code - 32 with heat sink

**Error Code:**  
32 - Outdoor PCB high temperature error

**Applicable Models:**  
Outdoor AC 3.5-5.0 ton  
Outdoor HP 3.5-5.0 ton

**Method of Error Detection:**  
Detected by thermistor on inverter cooling plate

**Error Decision Conditions:**  
When the temperature became excessive high

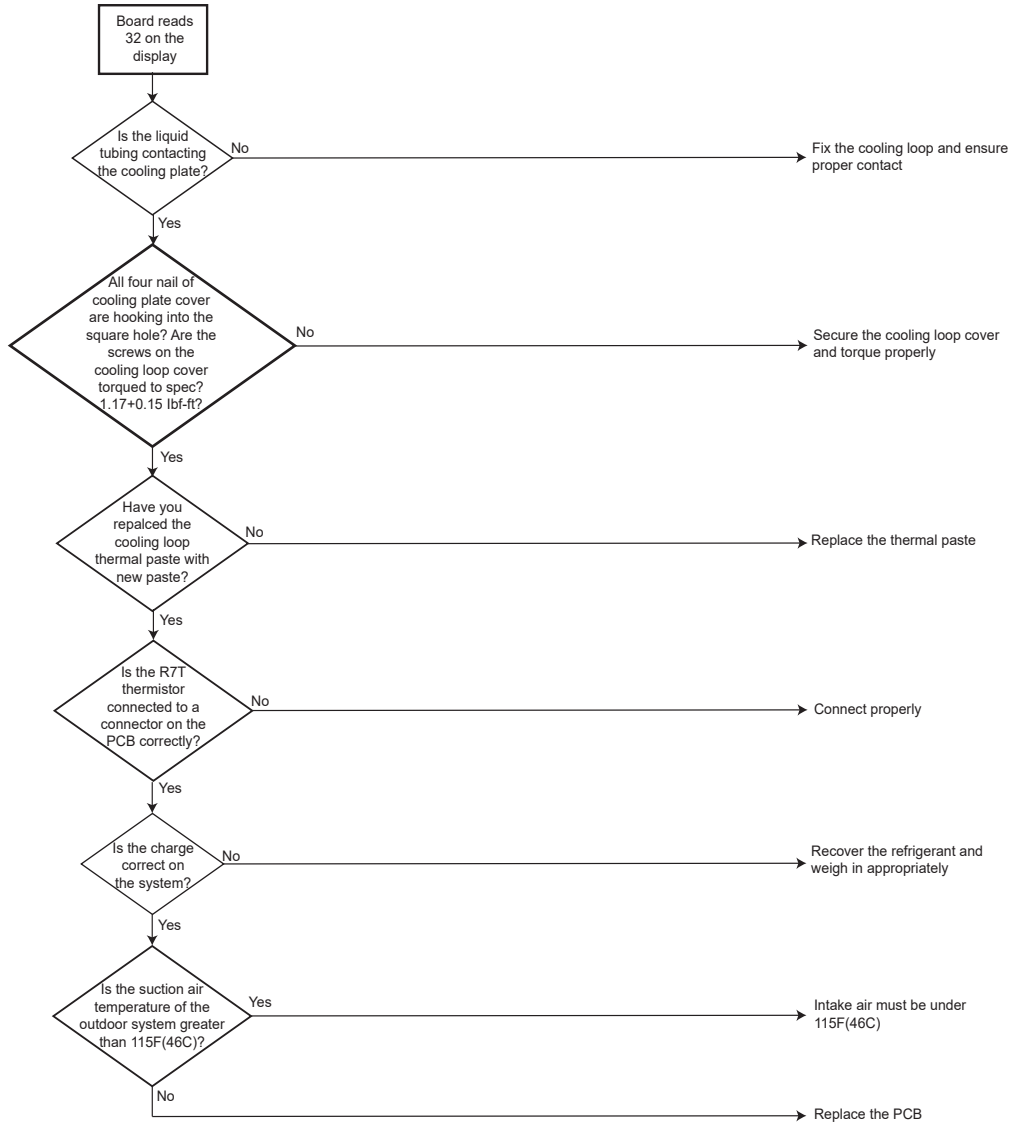

# Troubleshooting

# Error Code - 57

**Error Code:**  
57 - Refrigerant cooling sweat error

**Applicable Models:**  
Outdoor HP 3.5-5.0 ton

**Method of Error Detection:**  
Detected by outdoor liquid temperature

**Error Decision Conditions:**  
When outdoor liquid pipe temperature became excessive low during heating operation

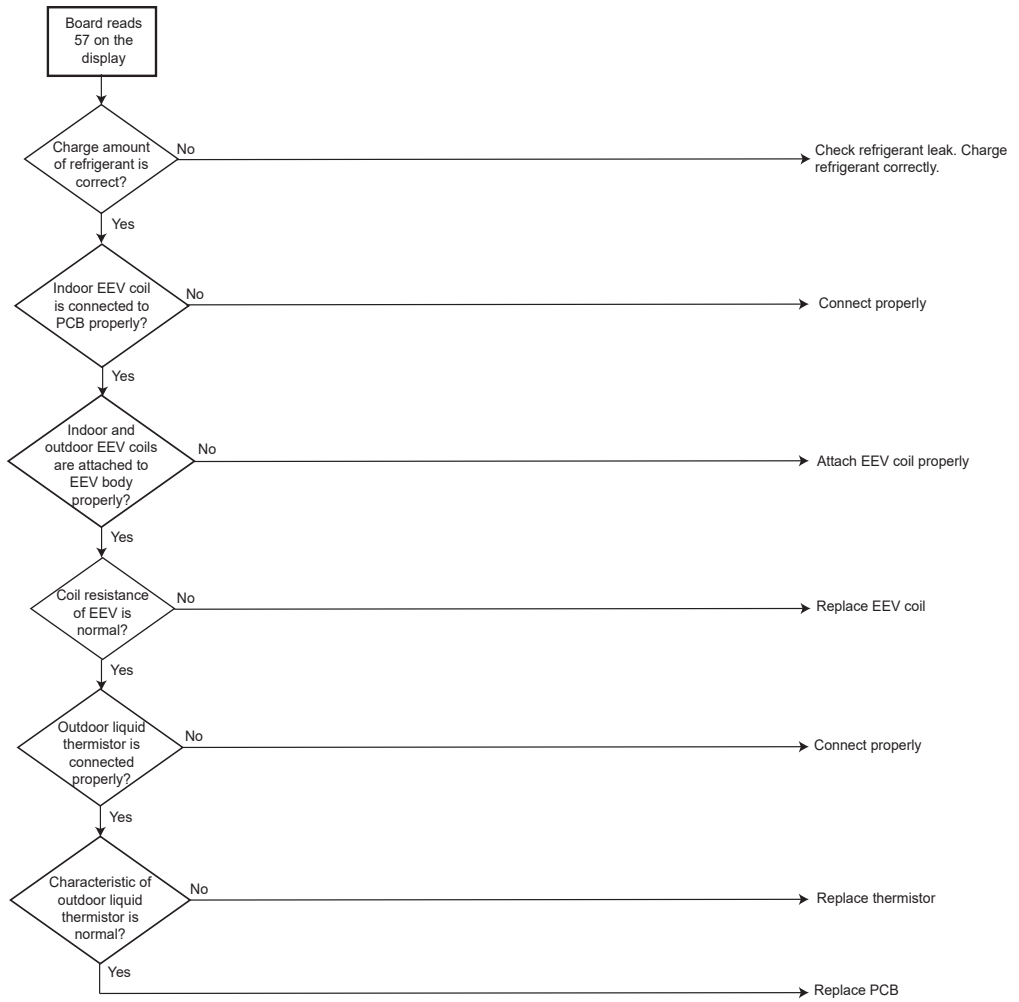

**Error Code:**  
70 - EEV open circuit

**Applicable Models:**  
DV\*\*FEC / DV\*\*PEC / CAPE(A) /  
CHPE

**Method of Error Detection:**  
Check indoor EEV coil connection

**Error Decision Conditions:**  
EEV connector not detected

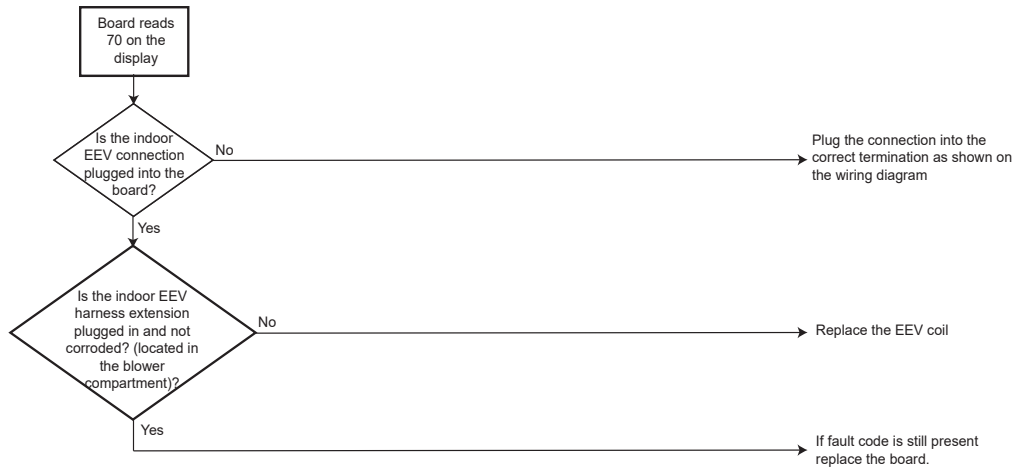



# Troubleshooting

# Error Code - 73

**Error Code:**  
73 - Liquid side thermistor abnormality

**Applicable Models:**  
DV\*\*FEC  
DV\*\*PEC  
CAPE(A)  
CHPE

**Method of Error Detection:**  
Check indoor thermistor resistance value (X15A, 4 and 5 pins)

**Error Decision Conditions:**  
Open or short circuit of the thermistor (When thermistor detected continuous 20 seconds about less than \*43.6C (-46.48F) or more than 90C (194F).) (When thermistor resistance less than 1342 ohm or more than 1.7M ohm)

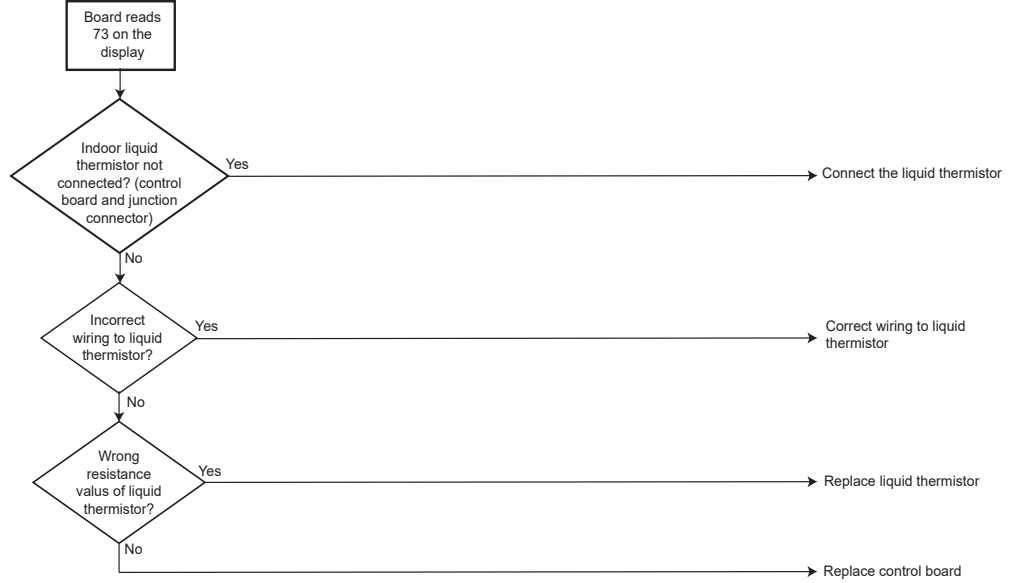

**Error Code:**  
74 - Gas side thermistor abnormality

**Applicable Models:**  
DV\*\*FEC  
DV\*\*PEC  
CAPE(A)  
CHPE

**Method of Error Detection:**  
Check indoor thermistor resistance value (X15A, 1 and 2 pin)

**Error Decision Conditions:**  
Open or short circuit of the thermistor (When thermistor detected continuous 20 seconds about less than -43.6C (146.48F) or more than 165C (329F), or when output DCV is about less than 0.04 VDC.) (When thermistor resistance less than 309 ohm or more than 1.7 M ohm)

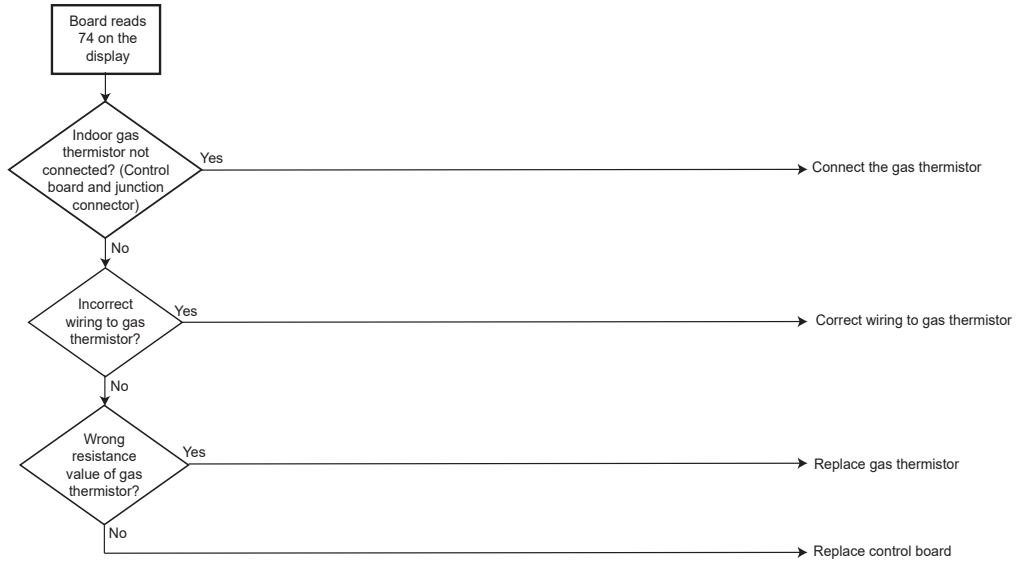

# Troubleshooting

# Error Code - 75

**Error Code:**  
75 - Pressure sensor abnormality

**Applicable Models:**  
DV\*\*FEC  
DV\*\*PEC  
CAPE(A)  
CHPE

**Method of Error Detection:**  
Check indoor thermistor resistance value (X16A,3 and 4 pin)

**Error Decision Conditions:**  
Open or short circuit of the pressure (When sensor detected continuous 5 minutes less than -0.049MPa (-7.11PSI) or more than 4.41MPa (640PSI) or when output DCV is about less than 0.13 VDC or more than 4.63 VDC.)

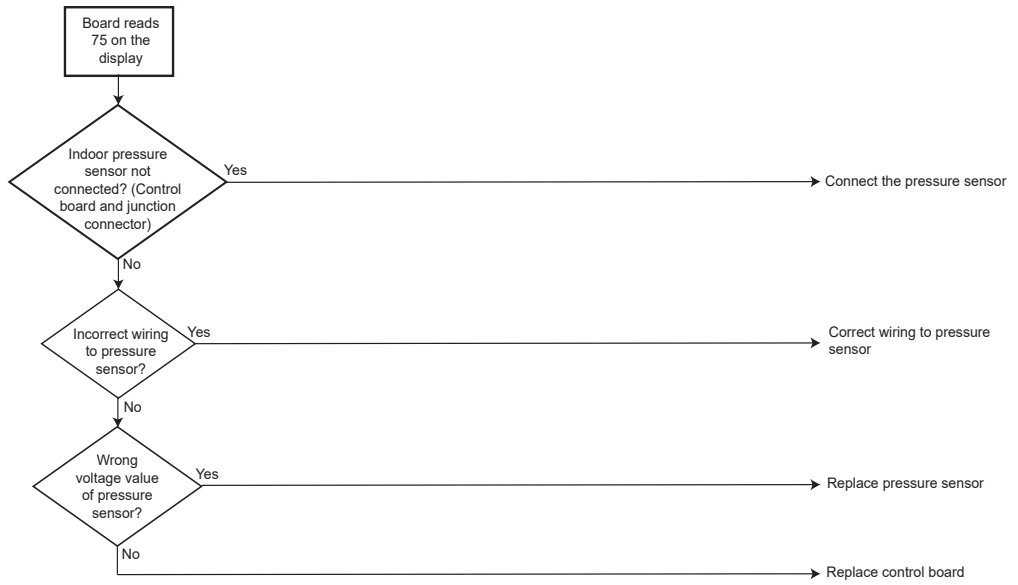

**Error Code:**  
77 - Indoor unit - Thermostat communication error (Start-up & during operation)

**Applicable Models:**  
DV\*\*FEC  
DV\*\*PEC  
CAPE(A)  
CHPE

**Method of Error Detection:**  
Check communicate connection

**Error Decision Conditions:**  
When a thermostat cant be recognized on a node list even if it passes for 60 seconds agter a node list is received. When receiving a node list newly during the above judgment, 60 seconds are recounted once again.

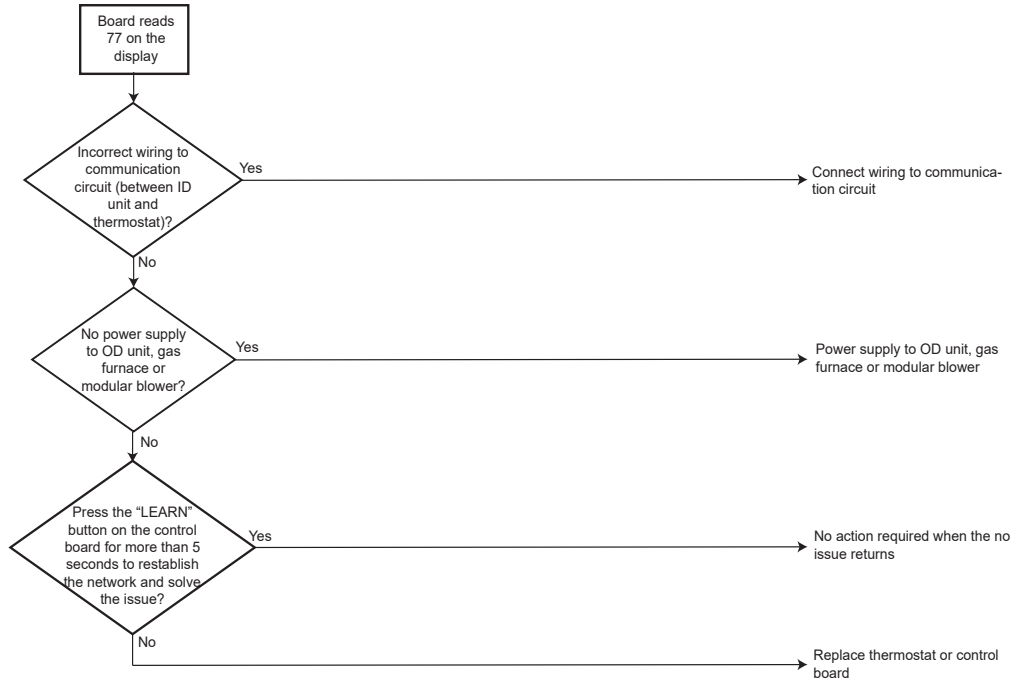

# Troubleshooting

# Error Code B0 & B1

**Error Code:**  
 B0 - Blower motor not running  
 B1 - Blower motor communication error

**Applicable Models:**  
 DV\*\*REC  
 DV\*\*PEC

**Method of Error Detection:**  
 B0 - Number of revolutions of the blower motor  
 B1 - Motor communication status

**Error Decision Conditions:**  
 B0 - When feedback rpm < 50 is detected for 5 times or when checked feedback rpm < 50 reached 100 times. (When checked feedback rpm reaches 720 times.)  
 B1 - When the communication from the motor can not be received correctly 5 seconds in a continuous.

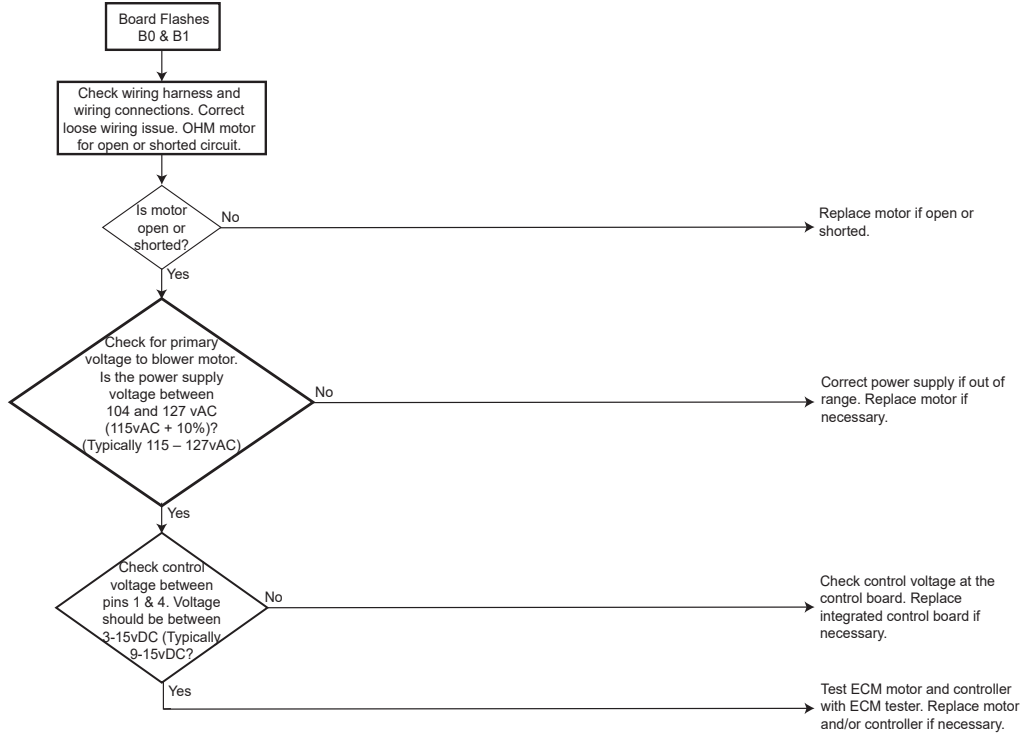

# Troubleshooting

# Error Code - B2-B6, B9

**Error Code:**  
 B2 - Blower motor operating in power, temp or speed limiting conditions  
 B3 - Circulating blower motor is operating in a power, temperature, or speed limiting condition  
 B4 - Blower motor- Current trip (or) lost rotor  
 B5 - Circulator blower motor fails to start 10 consecutive times  
 B6 - Circulator blower motor shuts down for over or under voltage condition. Circulator blower motor shuts down due to over temperature condition on power module  
 B9 - Low indoor airflow (with electric heat mode)

**Applicable Models:**  
 Indoor equipment

**Method of Error Detection:**  
 B2 - According to the control status flags of the motor  
 B3 - Air handler operates at reduced performance. Airflow delivered is less than expected  
 B4 - According to the control status flags of the motor  
 B5 - No air handler operation  
 B6 - No air handler operation  
 B9 - Number of revolutions of the blower motor

**Error Decision Conditions:**  
 B2 - When the motor sets Control Status Flags (bit3, bit4 or bit9) (\*).  
 bit3=Power limit  
 bit4=Temp limit  
 bit9=Over temp  
 B3 - When the motor sets Control Status Flags (bit3, bit4 or bit9) (\*).  
 bit3=Power limit  
 bit4=Temp limit  
 bit9=Over temp  
 B4 - When the motor sets Control Status Flags (bit5=1 or bit6=1) (\*).  
 bit5=Lost Rotor trip  
 bit6=Current trip  
 B5 - When the motor is locked up and the demand for operation has been presented 10 times with no operation  
 B6 - High/low voltage is detected in the controller.  
 B9 - When EH demand is active and the above conditions.  
 • When "50rpm<Feedback rpm"<"Minrpm(150rpm) " is detected for 10 times consecutively  
 Or  
 • When feedback from motor's rpm is 50rpm > and Min rpm (150rpm) and it happens 360 times.  
 (When checked rpm reaches 720 times,)

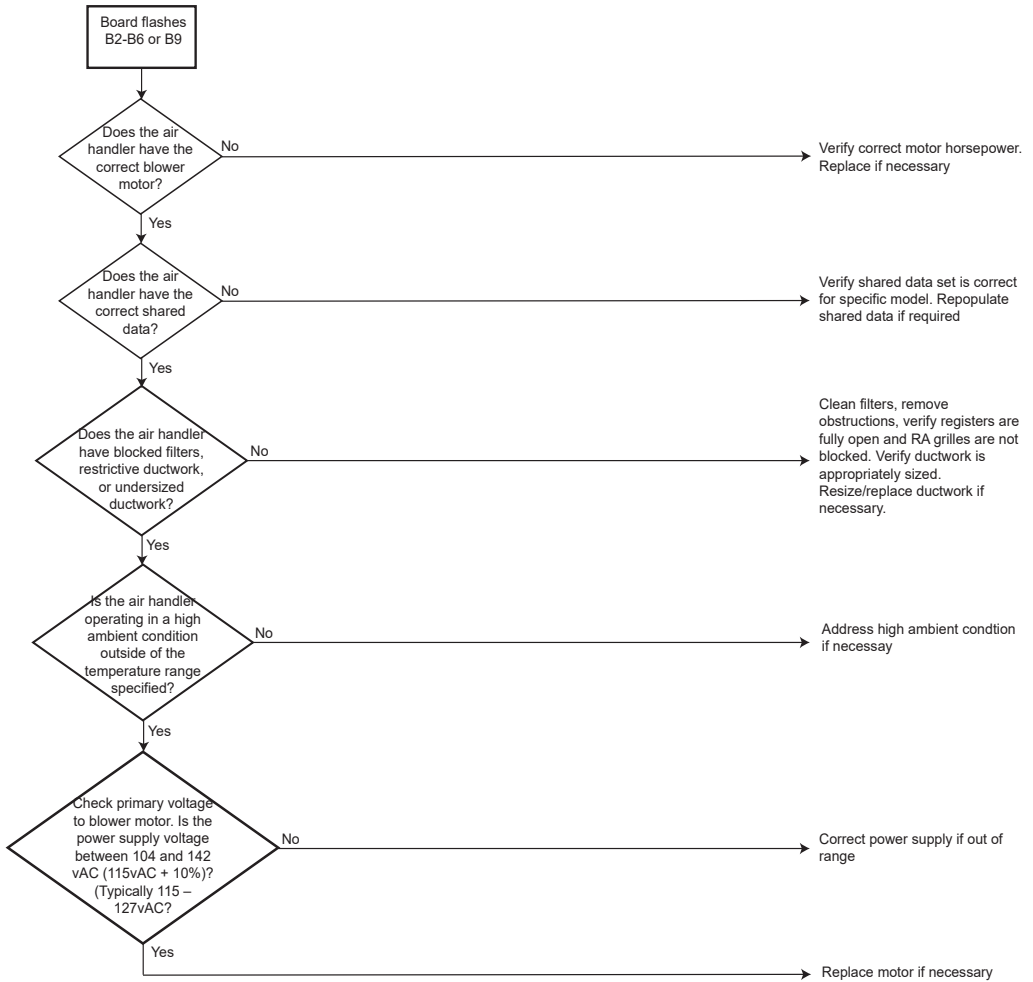

# Troubleshooting

# Error Code - B7

**Error Code:**  
B7 - ID blower motor does not have required parameters to function. Motor fails to start 40 consecutive times.

**Applicable Models:**  
EEV air handler

**Method of Error Detection:**  
According to the control status flags of the motor

**Error Decision Conditions:**  
When the motor sets control status flags =(bit10 = 1)

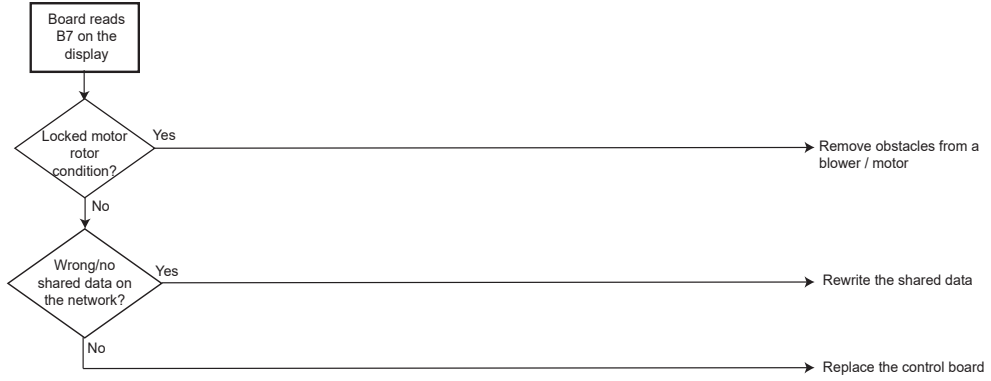

# Troubleshooting

# Error Code - B9

**Error Code:**  
B9 - Low indoor airflow (without electric heat mode)

**Applicable Models:**  
DV\*\*FEC  
DV\*\*PEC

**Method of Error Detection:**  
Number of revolutions of the blower motor

**Error Decision Conditions:**  
When no EH demand is active and the blower conditions

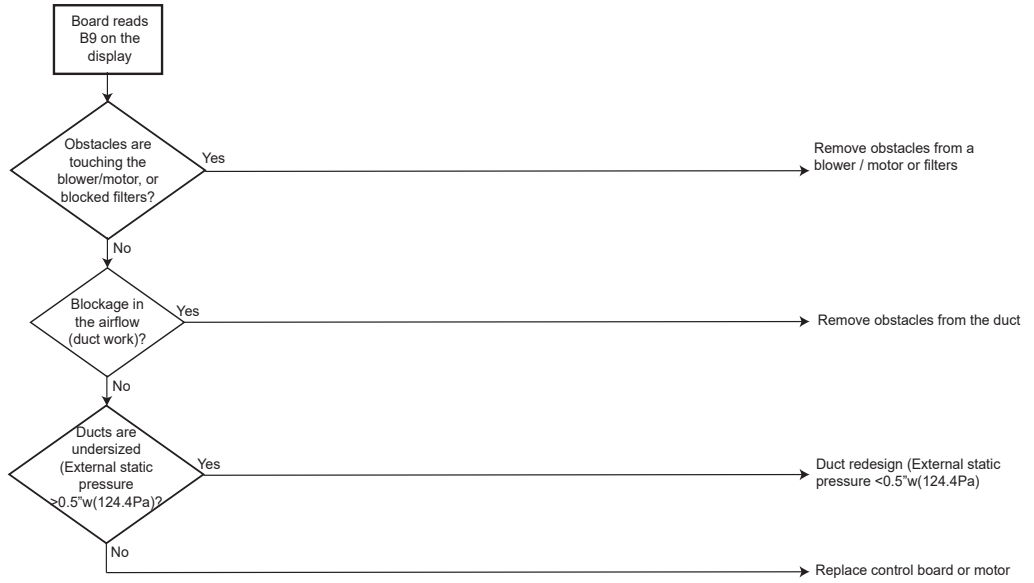



# Troubleshooting

# Error Code - D0, D1, D4

**Error Code:**  
D0 - Data not yet on network (No net data)  
D1 - Invalid data on network (Invalid data)  
D4 - Invalid bluetooth shared data loader BTSDL01 data (Invalid MC data)

**Applicable Models:**  
Indoor / outdoor equipment

**Method of Error Detection:**  
Shown on the system display

**Error Decision Conditions:**  
Air conditioner/heat pump fails to operate. Integrated control module diagnostic/ status LED display shows the indicated code

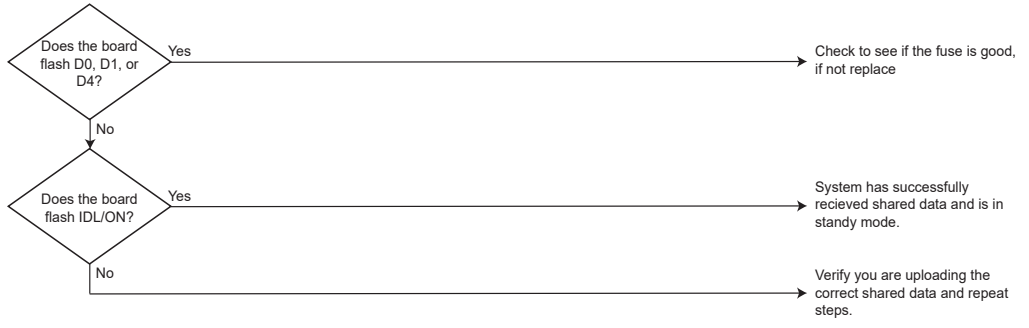

**Error Code:**  
d2 - System mismatch

**Applicable Models:**  
Outdoor AC  
Outdoor HP

**Method of Error Detection:**  
Communication data from indoor unit

**Error Decision Conditions:**  
When required CFM exceeds maximum CFM limit of the indoor unit. When a connected indoor unit is not EEV type.

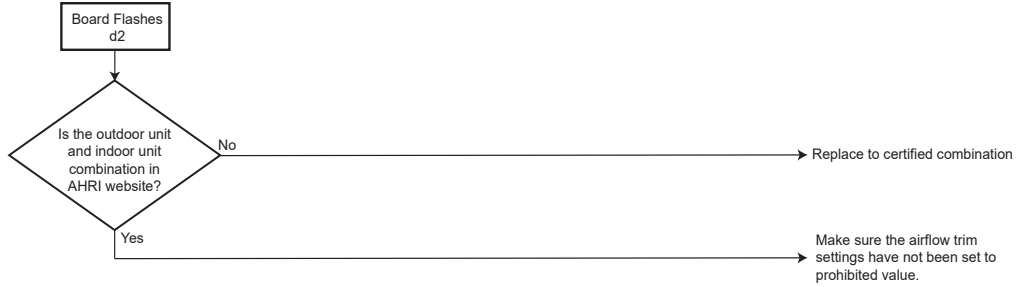

# Troubleshooting

# Error Code - EC

**Error Code:**  
EC - Heater too large / Heater too small / No heater match

**Applicable Models:**  
Indoor units

**Method of Error Detection:**  
Integrated control module LED display provides the indicated error

**Error Decision Conditions:**  
Electric heaters fail to energize on a call for W1 or Auxiliary Emergency heat. Electric heat airflow is higher than expected on a call for W1 or Auxiliary Emergency heat.

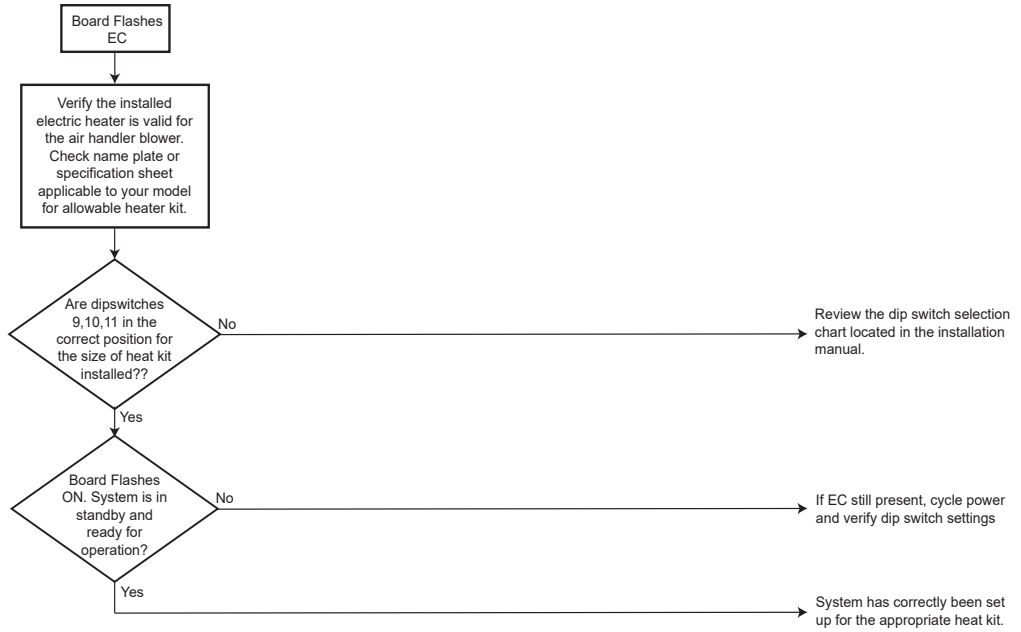

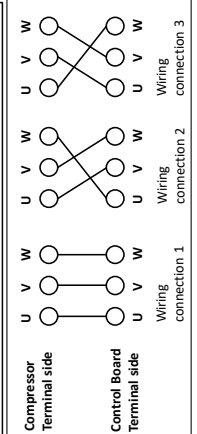
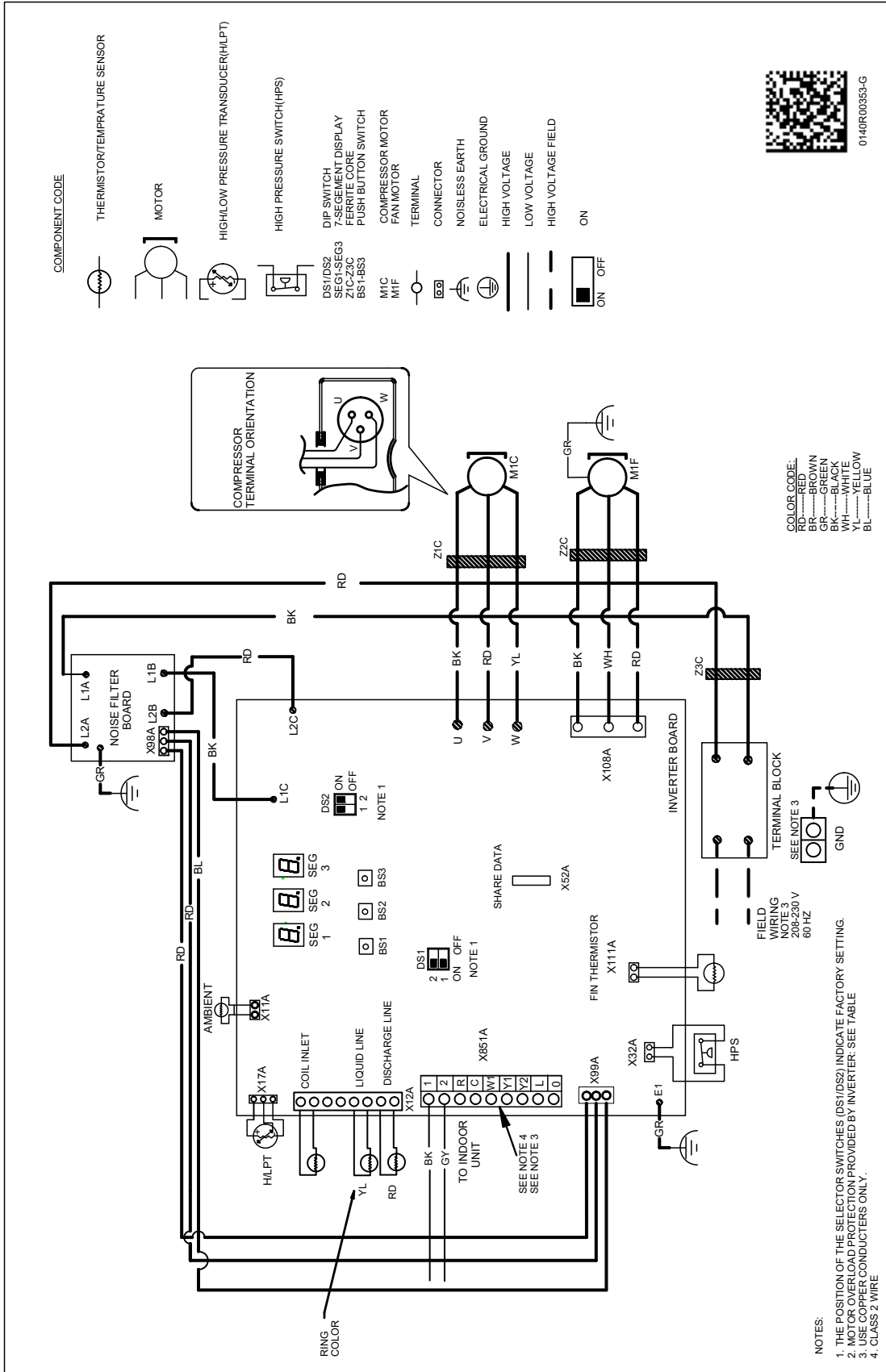

**NOTE:** The compressor can operate normally in any of the following wiring connections shown on the right.  
(Wiring connection between control board and compressor terminal)

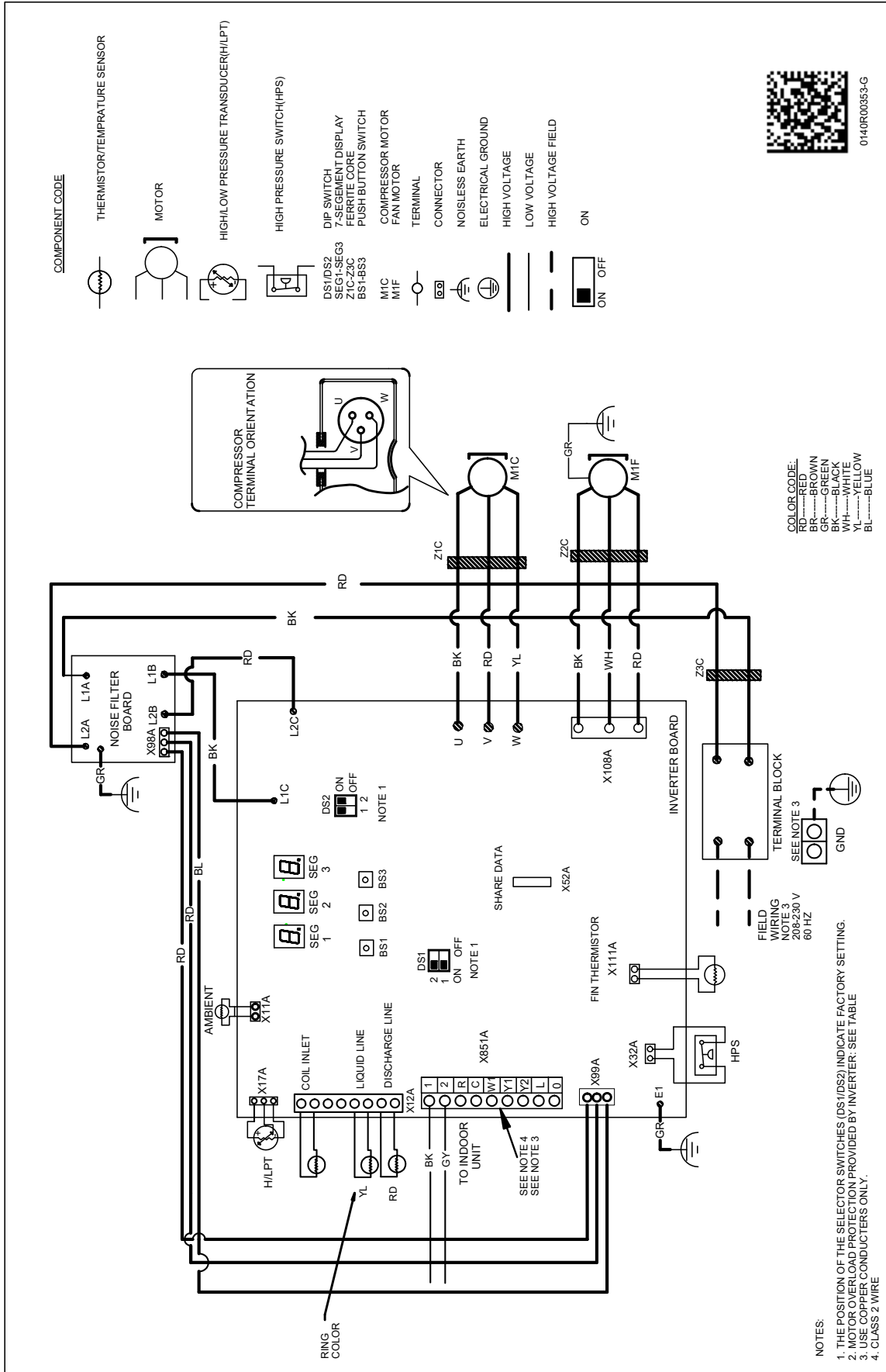



# WIRING DIAGRAM

**WARNING**

**HIGH VOLTAGE!**  
**DISCONNECT ALL POWER BEFORE SERVICING OR INSTALLING THIS UNIT.**  
**MULTIPLE POWER SOURCES MAY BE PRESENT. FAILURE TO DO SO MAY CAUSE PROPERTY DAMAGE, PERSONAL INJURY OR DEATH.**

## INDOOR UNIT FOR TXV APPLICABLE UNIT (MBVC\*\*00AA-A)

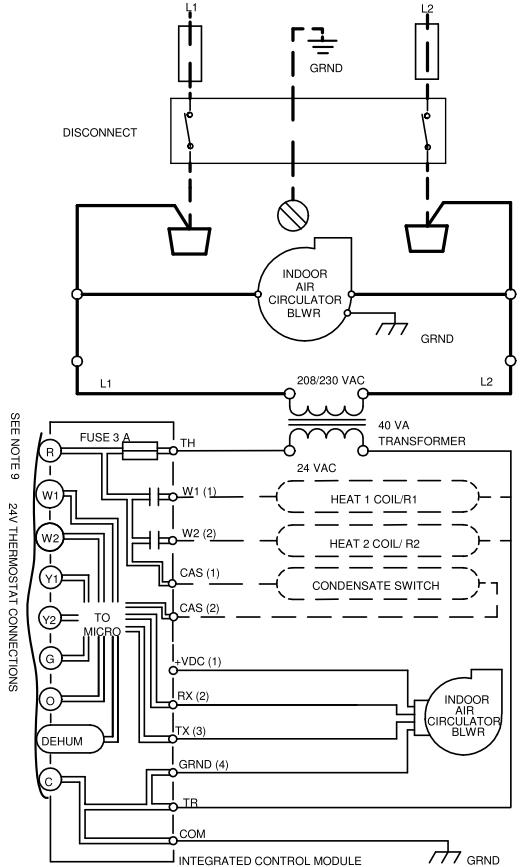
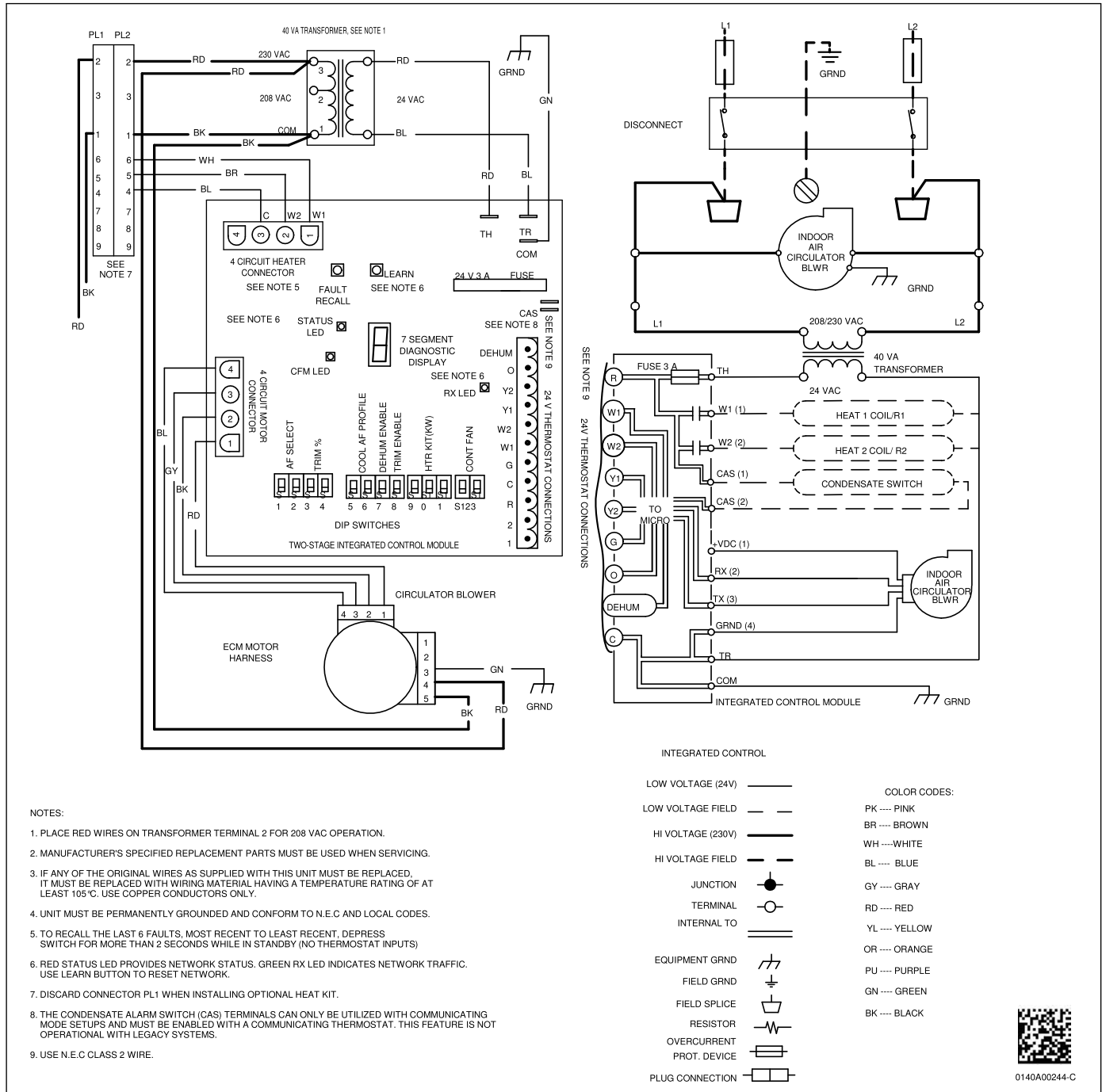

**INTEGRATED CONTROL**

LOW VOLTAGE (24V) ———	COLOR CODES:
LOW VOLTAGE FIELD - - -	PK ---- PINK
HI VOLTAGE (230V) ———	BR ---- BROWN
HI VOLTAGE FIELD - - -	WH ---- WHITE
JUNCTION ●	BL ---- BLUE
TERMINAL ○	GY ---- GRAY
INTERNAL TO ≡	RD ---- RED
EQUIPMENT GRND ⚡	YL ---- YELLOW
FIELD GRND ⚡	OR ---- ORANGE
FIELD SPLICE ⚡	PU ---- PURPLE
RESISTOR ⚡	GN ---- GREEN
OVERCURRENT ⚡	BK ---- BLACK
PROT. DEVICE ⚡	
PLUG CONNECTION ⚡	

- NOTES:**
- PLACE RED WIRES ON TRANSFORMER TERMINAL 2 FOR 208 VAC OPERATION.
  - MANUFACTURER'S SPECIFIED REPLACEMENT PARTS MUST BE USED WHEN SERVICING.
  - IF ANY OF THE ORIGINAL WIRES AS SUPPLIED WITH THIS UNIT MUST BE REPLACED, IT MUST BE REPLACED WITH WIRING MATERIAL HAVING A TEMPERATURE RATING OF AT LEAST 105°C. USE COPPER CONDUCTORS ONLY.
  - UNIT MUST BE PERMANENTLY GROUNDED AND CONFORM TO N.E.C AND LOCAL CODES.
  - TO RECALL THE LAST 6 FAULTS, MOST RECENT TO LEAST RECENT, DEPRESS SWITCH FOR MORE THAN 2 SECONDS WHILE IN STANDBY (NO THERMOSTAT INPUTS)
  - RED STATUS LED PROVIDES NETWORK STATUS. GREEN RX LED INDICATES NETWORK TRAFFIC. USE LEARN BUTTON TO RESET NETWORK.
  - DISCARD CONNECTOR PL1 WHEN INSTALLING OPTIONAL HEAT KIT.
  - THE CONDENSATE ALARM SWITCH (CAS) TERMINALS CAN ONLY BE UTILIZED WITH COMMUNICATING MODE SETUPS AND MUST BE ENABLED WITH A COMMUNICATING THERMOSTAT. THIS FEATURE IS NOT OPERATIONAL WITH LEGACY SYSTEMS.
  - USE N.E.C CLASS 2 WIRE.



0140A00244-C

Wiring is subject to change. Always refer to wiring diagram on the unit for the most up to date wiring.

# WIRING DIAGRAM

INDOOR UNIT FOR EEV APPLICABLE UNIT (AMVE\*\*)



**WARNING**

**HIGH VOLTAGE!**  
 DISCONNECT ALL POWER BEFORE SERVICING OR INSTALLING THIS UNIT.  
 MULTIPLE POWER SOURCES MAY BE PRESENT. FAILURE TO DO SO MAY  
 CAUSE PROPERTY DAMAGE, PERSONAL INJURY OR DEATH.

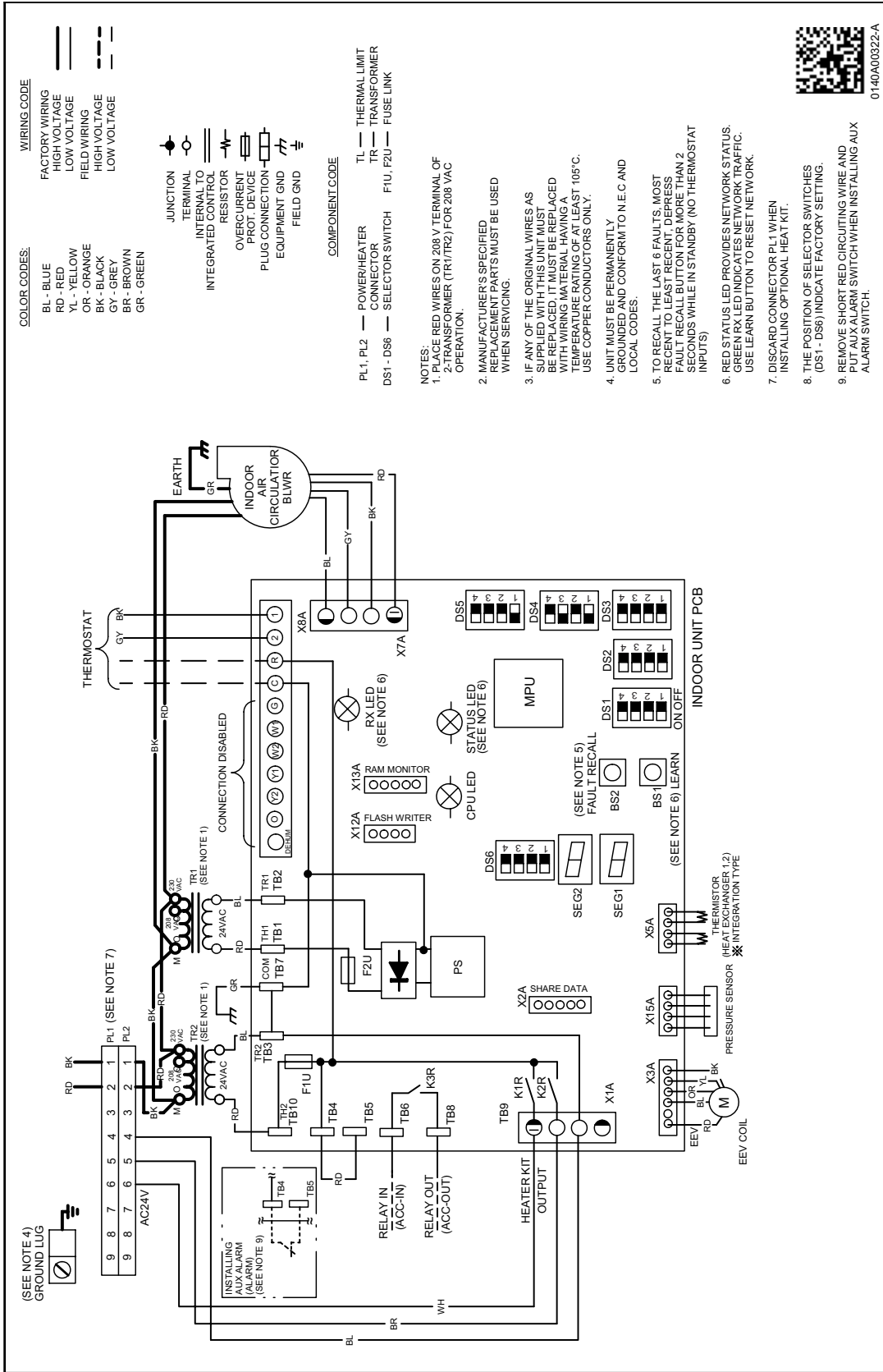

NOTE: The position of the black square indicates the setting position of the selector switches (DS1-DS6).



# ACCESSORIES

## EXPANSION VALVES

**\*SXV90\*\*10\*\***

Model Name	TXV-Kit
*SXV902410**	TXV-V24
*SXV903610**	TXV-V36
*SXV904810**	TXV-V48
*SXV906010**	TXV-V60

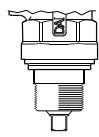
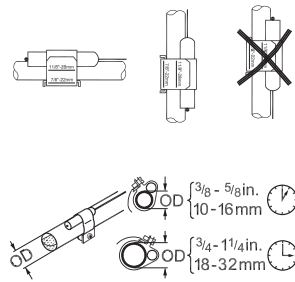
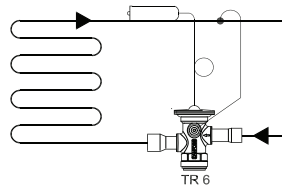
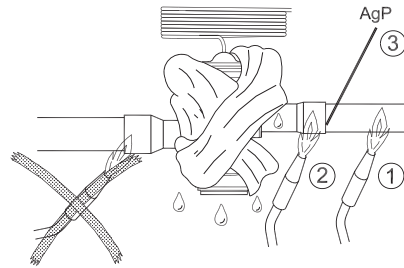
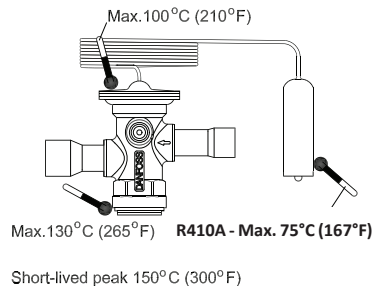

Ø=19mm (3/4 in.)  
T=10Nm (7ft-lbf)



SS = 2°C (3.6°F) or according to customer specification

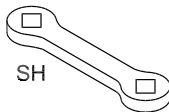

ΔSH/360° ≈ R410A: 0.6°C / turn - 1.1°F / turn

	Number of turns from SS to TIGHT Spring	Number of turns from SS to LOOSE Spring
	⊕	⊖
<b>R410A</b>	+9.5	-2

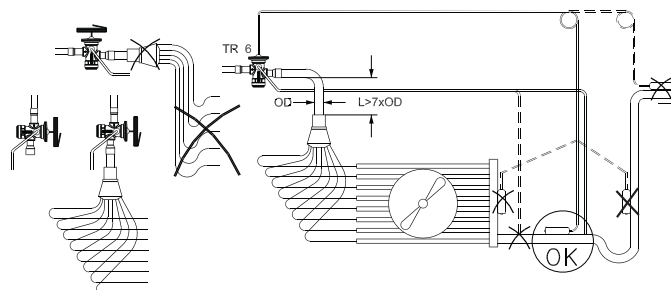

# ACCESSORIES

## AMVE

### HEATER KIT

MODELS	HKX03XC	HKX05XC	HKX06XC	HKX08XC	HKX10XC	HKC05XC	HKC08XC	HKC10XC	HKC15XA	HKC15XB	HKC15XF	HKC19CA	HKC19CB	HKC20DH	HKC20DB	HKC20XF	HKC25DA	HKC25DB
AMVE24BP14**	X	X	X	X	X	X	X	X										
AMVE36CP14**		X	X	X	X	X	X	X	X	X	X	X	X					
AMVE48DP14**		X	X	X	X	X	X	X		X	X			X	X			
AMVE60DP14**		X	X	X	X	X	X	X		X	X			X	X	X	X	X

\*Revision level that may or may not be designated.

NOTE: Airflow selection should meet the minimum requirements as mentioned in the air handler Installation instructions.

For heater kit installation, it is important to set the capacity of the electric heater at Set-up menu on the thermostat and DIP switch on indoor unit control board. For more information, please see indoor unit I/O manual.

ELECTRIC HEAT AIRFLOW TABLE							
Htr kW	9	10	11	AMVE24BP14**	AMVE36CP14**	AMVE48DP14**	AMVE60DP14**
3	ON	ON	ON	730	850**	NR	NR
5	ON	ON	OFF	780	1250	1250	1250
6	ON	OFF	ON	850	1300	1300	1300
8	ON	OFF	OFF	950	1500	1500	1500
10	OFF	ON	ON	1025	1550	1550	1550
15	OFF	ON	OFF	NR	1720	1720	1780
19*	OFF	OFF	ON	NR	NR	NR	NR
20				NR	1800	1815	1850
21 or 25*	OFF	OFF	OFF	NR	NR	1850	1850

NOTE: Airflow data shown applies to the electric heat only in either legacy mode or communicating mode operation.

NR- Not rated

+For match up with a 2 ton outdoor unit: Heater kit application shall not exceed 10 kW.  
Airflow for 5 kW up to 10 kW heater kits shall be set to 850 cfm speed tap of ON-ON-ON.

++For match up with a 3 ton outdoor unit: Heater kit application shall not exceed 15 kW.  
Airflow for 5 kW up to 15 kW heater kits shall be set to 1300 cfm speed tap of ON-OFF-ON.

Airflow for 5 kW up to 20 kW heater kits shall be set to 1500 cfm speed tap of ON-OFF-OFF

\*\* 3 kW heater kit is not applicable for this indoor application.