

Service and Troubleshooting

ASXC, DSXC, AND GSXC CONDENSING UNITS, ASZC, DSZC, AND GSZC SPLIT SYSTEM HEAT PUMPS WITH R-410A REFRIGERANT BLOWERS, COILS, & ACCESSORIES

Pride and workmanship go into every product to provide our customers with quality products. It is possible, however, that during its lifetime a product may require service. Products should be serviced only by a qualified service technician who is familiar with the safety procedures required in the repair and who is equipped with the proper tools, parts, testing instruments and the appropriate service manual. **REVIEW ALL SERVICE INFORMATION IN THE APPROPRIATE SERVICE MANUAL BEFORE BEGINNING REPAIRS.**

For service information related to the Bluetooth® Shared Data Loader BTSDL01 referenced in this manual, please refer to the installation instructions for the BTSDL01 at www.coolcloudhvac.com/loaderuserguide.



WARNING

ONLY PERSONNEL THAT HAVE BEEN TRAINED TO INSTALL, ADJUST, SERVICE, MAINTENANCE OR REPAIR (HEREINAFTER, "SERVICE") THE EQUIPMENT SPECIFIED IN THIS MANUAL SHOULD SERVICE THE EQUIPMENT.

THIS EQUIPMENT IS NOT INTENDED FOR USE BY PERSONS (INCLUDING CHILDREN) WITH REDUCED PHYSICAL, SENSORY OR MENTAL CAPABILITIES, OR LACK OF EXPERIENCE AND KNOWLEDGE, UNLESS THEY HAVE BEEN GIVEN SUPERVISION OR INSTRUCTION CONCERNING USE OF THE APPLIANCE BY A PERSON RESPONSIBLE FOR THEIR SAFETY.

CHILDREN SHOULD BE SUPERVISED TO ENSURE THAT THEY DO NOT PLAY WITH THE EQUIPMENT.

THE MANUFACTURER WILL NOT BE RESPONSIBLE FOR ANY INJURY OR PROPERTY DAMAGE ARISING FROM IMPROPER SUPERVISION, SERVICE OR SERVICE PROCEDURES. IF YOU SERVICE THIS UNIT, YOU ASSUME RESPONSIBILITY FOR ANY INJURY OR PROPERTY DAMAGE WHICH MAY RESULT. IN ADDITION, IN JURISDICTIONS THAT REQUIRE ONE OR MORE LICENSES TO SERVICE THE EQUIPMENT SPECIFIED IN THIS MANUAL, ONLY LICENSED PERSONNEL SHOULD SERVICE THE EQUIPMENT. IMPROPER SUPERVISION, INSTALLATION, ADJUSTMENT, SERVICING, MAINTENANCE OR REPAIR OF THE EQUIPMENT SPECIFIED IN THIS MANUAL, OR ATTEMPTING TO INSTALL, ADJUST, SERVICE OR REPAIR THE EQUIPMENT SPECIFIED IN THIS MANUAL WITHOUT PROPER SUPERVISION OR TRAINING MAY RESULT IN PRODUCT DAMAGE, PROPERTY DAMAGE, PERSONAL INJURY OR DEATH.



WARNING

DO NOT BYPASS SAFETY DEVICES.

RS6200007r27
May 2023

©2019-2023 Daikin Comfort Technologies Manufacturing, L.P.

Amana® is a registered trademark of Maytag Corporation or its related companies and is used under license. All rights reserved.

IMPORTANT INFORMATION

TABLE OF CONTENTS

IMPORTANT INFORMATION.....	2	CHECKING HEATER FUSE LINK (OPTIONAL ELECTRIC HEATERS).....	46
PRODUCT INFORMATION.....	4	CHECKING HEATER ELEMENTS	47
SYSTEM OPERATION.....	19	REFRIGERATION REPAIR PRACTICE	47
SERVICING.....	27	LEAK TESTING (NITROGEN OR NITROGEN-TRACED)	47
CHECKING VOLTAGE	27	SYSTEM EVACUATION	48
CHECKING WIRING	27	DEEP VACUUM METHOD.....	48
COMFORTBRIDGE™ TECHNOLOGY AIR HANDLER (B*).....	27	TRIPLE EVACUATION METHOD.....	48
CHECKING TRANSFORMER AND CONTROL CIRCUIT.....	33	CHARGING	49
CHECKING TIME DELAY RELAY	33	FINAL CHARGE ADJUSTMENT	49
CHECKING UNITARY (UC) CONTROL COMPRESSOR.....	33	CHECKING COMPRESSOR EFFICIENCY	50
CHECKING HIGH AND LOW VOLTAGE TO ECM MOTOR	33	OVERFEEDING	50
COPELAND COMFORT ALERT™ - UNITARY (UC) CONTROL DIAGNOSTICS APPLIES TO ASXC, ASZC, AND DSZC 2-STAGE MODELS	33	UNDERFEEDING.....	50
CHECKING HIGH PRESSURE CONTROL	34	SUPERHEAT	51
CHECKING LOW PRESSURE CONTROL	34	CHECKING SUPERHEAT	51
CHECKING HIGH AND LOW PRESSURE SWITCH VOLTAGE.....	34	CHECKING SUBCOOLING.....	51
CHECKING CAPACITOR.....	35	CHECKING EXPANSION VALVE OPERATION.....	52
RESISTANCE CHECK USING A DIGITAL MULTI-METER	35	CHECKING RESTRICTED LIQUID LINE	56
CAPACITANCE CHECK USING A DIGITAL MULTI-METER (IN CAPACITANCE MODE)	35	OVERCHARGE OF REFRIGERANT	56
TESTING A RUN CAPACITOR UNDER LOAD.....	36	NON-CONDENSABLES.....	56
CHECKING EMERSON ULTRATECH™ ECM MOTORS.....	36	COMPRESSOR BURNOUT.....	56
CHECKING COMPRESSOR.....	38	REFRIGERANT PIPING.....	57
RESISTANCE TEST	39	SINGLE PIECE AIR HANDLER EXTERNAL STATIC PRESSURE	57
GROUND TEST	39	TWO PIECE AIR HANDLER EXTERNAL STATIC PRESSURE	58
UNLOADER TEST PROCEDURE WITH COMFORT ALERT™ UNITARY (UC) CONTROL DIAGNOSTICS	40	MAINTENANCE	58
LOCKED ROTOR TEST	40	WIRING DIAGRAM	101
OPERATION TEST	40		
TESTING CRANKCASE HEATER (OPTIONAL ITEM).....	41		
CHECKING REVERSING VALVE AND SOLENOID ...	41		
TESTING DEFROST CONTROL	42		
TESTING TEMPERATURE SENSORS (COMMUNICATING READY MODELS ONLY)	42		
AVPTC/MBVC HEATER CONTROL.....	42		
ELECTRIC HEATER (OPTIONAL ITEM)	44		
CHECKING HEATER LIMIT CONTROL(S)	46		

OUTSIDE THE U.S., call 1-713-861-2500.

(Not a technical assistance line for dealers.) Your telephone company will bill you for the call.

IMPORTANT INFORMATION

IMPORTANT NOTICES

RECOGNIZE SAFETY SYMBOLS, WORDS AND LABELS



WARNING

TO PREVENT THE RISK OF PROPERTY DAMAGE, PERSONAL INJURY OR DEATH, DO NOT STORE COMBUSTIBLE MATERIALS OR USE GASOLINE OR OTHER FLAMMABLE LIQUIDS OR VAPORS IN THE VICINITY OF THIS APPLIANCE.



WARNING

HIGH VOLTAGE
DISCONNECT ALL POWER BEFORE SERVICING OR INSTALLING THIS UNIT. MULTIPLE POWER SOURCES MAY BE PRESENT. FAILURE TO DO SO MAY CAUSE PROPERTY DAMAGE, PERSONAL INJURY OR DEATH.



WARNING

THIS UNIT SHOULD NOT BE CONNECTED TO, OR USED IN CONJUNCTION WITH, ANY DEVICES THAT ARE NOT DESIGN CERTIFIED FOR USE WITH THIS UNIT OR HAVE NOT BEEN TESTED AND APPROVED BY THE MANUFACTURER. SERIOUS PROPERTY DAMAGE OR PERSONAL INJURY, REDUCED UNIT PERFORMANCE AND/OR HAZARDOUS CONDITIONS MAY RESULT FROM USE OF DEVICES THAT HAVE NOT BEEN APPROVED OR CERTIFIED BY THE MANUFACTURER.

SAFE REFRIGERANT HANDLING

While these items will not cover every conceivable situation, they should serve as a useful guide.



WARNING

REFRIGERANTS ARE HEAVIER THAN AIR. THEY CAN "PUSH OUT" THE OXYGEN IN YOUR LUNGS OR IN ANY ENCLOSED SPACE. TO AVOID POSSIBLE DIFFICULTY IN BREATHING OR DEATH:

- NEVER PURGE REFRIGERANT INTO AN ENCLOSED ROOM OR SPACE. BY LAW, ALL REFRIGERANT MUST BE RECLAIMED.
- IF AN INDOOR LEAK IS SUSPECTED, THOROUGHLY VENTILATE THE AREA BEFORE BEGINNING WORK.
- LIQUID REFRIGERANT CAN BE VERY COLD. TO AVOID POSSIBLE FROSTBITE OR BLINDNESS, AVOID CONTACT WITH REFRIGERANT AND WEAR GLOVES AND GOGGLES. IF LIQUID REFRIGERANT DOES CONTACT YOUR SKIN OR EYES, SEEK MEDICAL HELP IMMEDIATELY.
- ALWAYS FOLLOW EPA REGULATIONS. NEVER BURN REFRIGERANT, AS POISONOUS GAS WILL BE PRODUCED.



WARNING

TO AVOID POSSIBLE INJURY, EXPLOSION OR DEATH, PRACTICE SAFE HANDLING OF REFRIGERANTS.



WARNING

THE COMPRESSOR POE OIL FOR R-410A UNITS IS EXTREMELY SUSCEPTIBLE TO MOISTURE ABSORPTION AND COULD CAUSE COMPRESSOR FAILURE. DO NOT LEAVE SYSTEM OPEN TO ATMOSPHERE ANY LONGER THAN NECESSARY FOR INSTALLATION.



WARNING

TO AVOID POSSIBLE EXPLOSION:

- NEVER APPLY FLAME OR STEAM TO A REFRIGERANT CYLINDER. IF YOU MUST HEAT A CYLINDER FOR FASTER CHARGING, PARTIALLY IMMERSE IT IN WARM WATER.
- NEVER FILL A CYLINDER MORE THAN 80% FULL OF LIQUID REFRIGERANT.
- NEVER ADD ANYTHING OTHER THAN R-22 TO AN R-22 CYLINDER OR R-410A TO AN R-410A CYLINDER. THE SERVICE EQUIPMENT USED MUST BE LISTED OR CERTIFIED FOR THE TYPE OF REFRIGERANT USED.
- STORE CYLINDERS IN A COOL, DRY PLACE. NEVER USE A CYLINDER AS A PLATFORM OR A ROLLER.



WARNING

TO AVOID POSSIBLE EXPLOSION, USE ONLY RETURNABLE (NOT DISPOSABLE) SERVICE CYLINDERS WHEN REMOVING REFRIGERANT FROM A SYSTEM.

- ENSURE THE CYLINDER IS FREE OF DAMAGE WHICH COULD LEAD TO A LEAK OR EXPLOSION.
 - ENSURE THE HYDROSTATIC TEST DATE DOES NOT EXCEED 5 YEARS.
 - ENSURE THE PRESSURE RATING MEETS OR EXCEEDS 400 LBS.
- WHEN IN DOUBT, DO NOT USE CYLINDER.

PRODUCT IDENTIFICATION

	A	S	X	C	16	036	1	**	
	1	2	3	4	5,6	7,8,9	10	11,12	
Brand	Amana® Brand High Feature Set								Engineering *
									Major/ Minor Revisions
									* Not used for order or inventory control
Product Category	S Split System								Electrical
									1- 208/230 V, 1 Phase, 60 Hz
Unit Type	X Condenser R-410A Z Heat Pump R-410A								Nominal Capacity
									024 2 Tons 048 4 Tons
									036 3 Tons 060 5 Tons
Communication Feature	C Integrated communicating ComfortBridge™ Technology								Efficiency
									16 16 SEER 18 18 SEER 20 20 SEER

	A	S	Z	C	7	A	36	1	0	A	A	
	1	2	3	4	5	6	7,8	9	10	11	12	
Brand	Amana® Brand											Minor Revision
												A
Product Category	S – Split System R-410A											Major Revision
												A
Unit Type	X Condenser Z Heat Pump											Variation
Feature	N – Single Stage H – Enhanced B – Two Stage C – Premium M – Multi-Family V – Ultimate											Electrical
												208/230 V, 1 Phase, 60 Hz
SEER2	13.4 – 13.7 = 3 16.6 - 17.5 = 7 13.8 – 14.5 = 4 17.6 - 18.5 = 8 14.6 – 15.5 = 3 18.6 - 19.5 = 9 15.6 – 16.5 = 6 19.6 + = 0											Nominal Capacity
												18 - 1½ tons 42- 3½ Tons
												24 - 2 tons 48- 4 Tons
												30 - 2½ tons 60- 5 Tons
												36 - 3 tons
												Sales Region
												N - North O - All Regions S - Southeast & North

PRODUCT IDENTIFICATION

	A	M	V	T	36	B	P	1	4	05	A	
	1	2	3	4	5,6	7	8	9	10	11,12	13,14	
Product											Engineering *	
A Corporate Air Handler											Major/Minor Revisions	
D Daikin Air Handler											A - Initial Release B - 1st Revision	
Unit Application											Electric Heat KW	
C Ceiling Mount											5 = 5kw	
M Multi-Positional											8 = 8kw	
W Wall Mount											10 = 10kw	
F Fit Compatible Multi-Positional											Refrigerant	
H Horizontal Discharge Compatible Multi-Positional											3 - R32	
Motor											4 - R410A	
S MS-ECM											6 - R410A or R22	
V VS-ECM Communicating											Electrical	
Expansion Device											1 208/240 V, 1 Phase, 60 Hz	
E Electronic Expansion Valve											Cabinet	
F Flowrator											N - Uncased	
T Thermal Expansion Valve											P - Painted	
Nominal Capacity Range											U - Unpainted	
12 = 1 Ton	36 = 3.0 Tons									Cabinet Width		
18 = 1.5 Tons	42 = 3.5 Tons									AC* Series	AM* Series	AW* Series
24 = 2.0 Tons	48 = 4.0 Tons									M = 43.25"	B = 17.5"	S = 20.2"
30 = 2.5 Tons	60 = 5.0 Tons									L = 49.25"	C = 21.0"	L = 24.0"
											D = 24.5"	

*denotes ahri wild cards

PRODUCT IDENTIFICATION



C A P F A 1 8 1 4 A 6 A A
1 2 3 4 5 6 7 8 9 10 11 12 13

Product Category

C Indoor Coil

Application

A Upflow/Downflow
 H Horizontal

Cabinet Finish

U Uncased
 P Cased- Painted
 C Cased- Unpainted

Expansion Device

F Flowrater
 T TXV
 E Electronic Expansion Device

Coil Configuration

A A Coil
 S Slab

Engineering

Major/ Minor Revisions

Refrigerant

2- R-22 only
 4- R-410A only
 6- R-22 or R-410A compatible

Nominal Width for Gas Furnace

A- 14" Width D- 24.5" Width
 B- 17.5" Width N- Not Applicable (Slab Coil)
 C- 21" Width

Cased Height

14- 14" Coil 22- 22" Coil
 18- 18" Coil 26- 26" Coil
 30- 30" Coil

Nominal Capacity Range

17, 18- 1.5 Tons 29, 30- 2.5 Tons 42- 3.5 Tons 60- 5 Tons
 23, 24- 2 Tons 35, 36- 3 Tons 48- 4 Tons

PRODUCT IDENTIFICATION

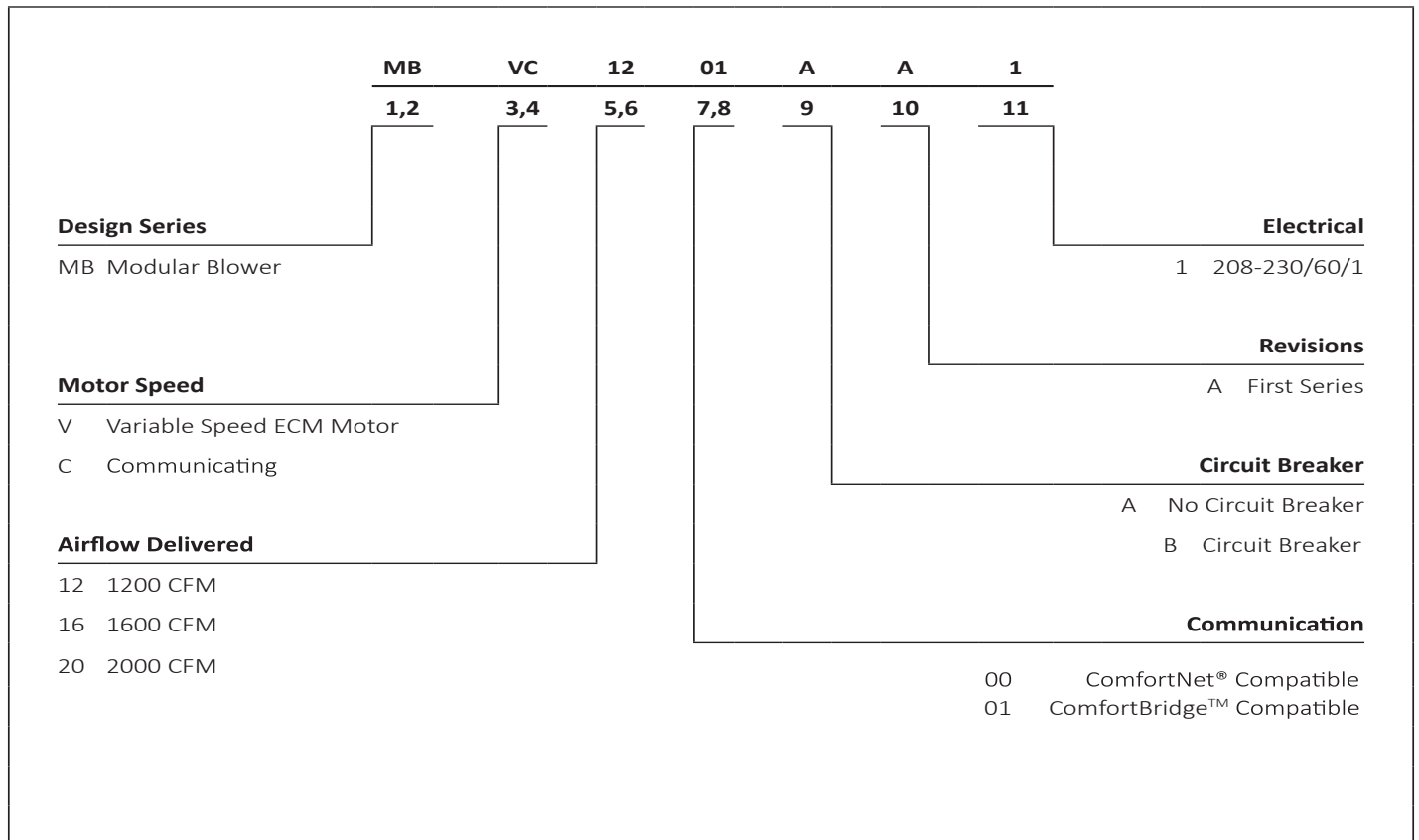
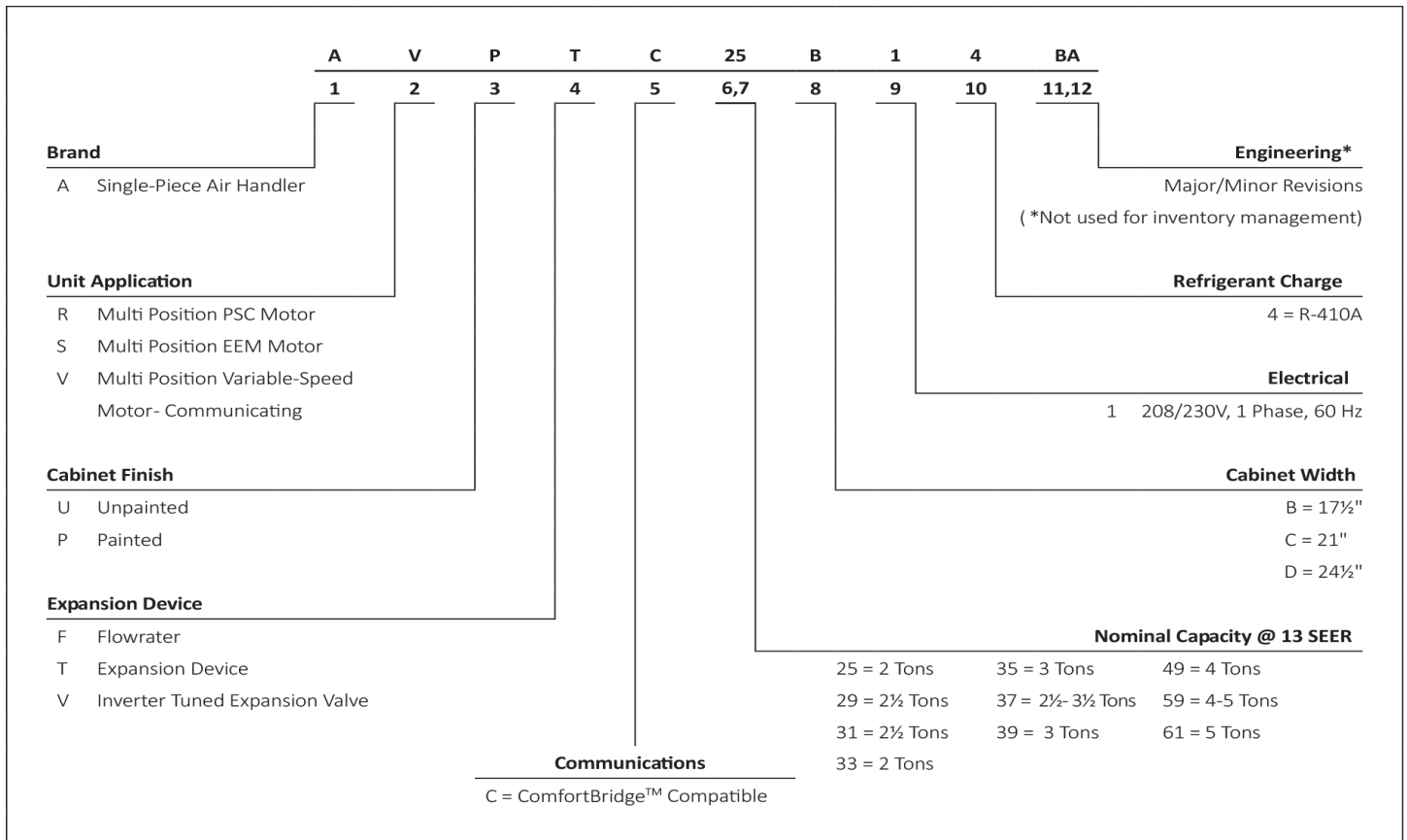

PRODUCT IDENTIFICATION

ASXC16	
AMANA® BRAND SPLIT X-COMMUNICATING CONDENSERS R-410A 16 SEER	
Model/Rev	Description
ASXC160**1AA	Introduces Amana® brand 2-stage 16 SEER condensing units with R-410A, communicating models.
ASXC160601BA	Use ZPS49 compressor.
ASXC160481BA	SmartCoil® coils
ASXC160(24/36)1BB	Wiring diagram updated with notes.
ASXC160(48-60)1BB	Motor changed to Nidec.
ASXC160(24/36)1BC ASXC160(48-60)1BC	Ultratech® 2.0 compressor change.
ASXC160(24/36)1BD ASXC160(48-60)1BD	Replaced PCBHR103 Communicating Heat Pump Control Board with PCBHR104 Communicating Heat Pump Control Board.
ASXC160(241, 481)BE	Refrigerant charge reduction
ASXC160(24,36,48,60)1CA	16 SEER 2-Stage AC Development with improved performance.

ASXC18	
AMANA® BRAND SPLIT X-COMMUNICATING CONDENSERS R-410A 18 SEER	
Model/Rev	Description
ASXC18**1AA	Initial release of Amana® brand 2-stage 16 SEER condensing units with R-410A, communicating models.
ASXC180(36/48/60)1AB	Wiring diagram updated with notes.
ASXC180(36/48-60)1AC	Replaced compressors ZPS20K4EPFV230 with ZPS20K5EPFV130 and compressor ZPS30K4EPFV230 with ZPS30K5EPFV130.
ASXC180(36/48-60)1AD	Replaced PCBHR103 Communicating Heat Pump Control Board with PCBHR104 Communicating Heat Pump Control Board.
ASXC180(24/36/48/60)BA	18 SEER 2-Stage AC Development with improved performance.
ASX180481BB	[Design Improvement]: Updating shared data for 18 SEER, 2-stage, 4 ton AC in communicating installations. Releasing minor revision for affected models.

PRODUCT IDENTIFICATION

GSXC16	
GOODMAN® BRAND SPLIT X-COMMUNICATING CONDENSERS R-410A 16 SEER	
Model/Rev	Description
GSXC160(24/36/48/60)1CA	16 SEER 2-Stage AC Development with improved performance.

GSXC18	
GOODMAN® BRAND SPLIT X-COMMUNICATING CONDENSERS R-410A 18 SEER	
Model/Rev	Description
GSXC180(24/36/48/60)1BA	18 SEER 2-Stage AC Development with improved performance.
GSXC180481BB	[Design Improvement]: Updating shared data for 18 SEER, 2-stage, 4 ton AC in communicating installations. Releasing minor revision for affected models
GSXC180(24/36/48/60)1BA	18 SEER 2-Stage AC Development with improved performance.

PRODUCT IDENTIFICATION

DSXC16	
DELUXE SPLIT X-COMMUNICATING CONDENSERS R-410A 16 SEER	
Model/Rev	Description
DSXC160**1AA	Initial release of Goodman® Deluxe brand 2-stage 16 SEER condensing units with R-410A, communicating models.
DSXC160(24/36)1AB	Wiring diagram updated with notes.
DSXC160(24/36)1AC DSXC160(48-60)1BC	Ultratech® 2.0 compressor.
DSXC160481BA	SmartCoil® coils.
DSXC160601BA	ZPS49K compressor.
DSXC160(48-60)1BB	Motor changed to Nidec.
DSXC160241AF DSXC160481BE	Refrigerant charge reduction

DSXC18	
DELUXE SPLIT X-COMMUNICATING CONDENSERS R-410A 18 SEER	
Model/Rev	Description
DSXC18**1AA	Initial release of Goodman® Deluxe brand 2-stage 18 SEER condensing units with R-410A, communicating models.
DSXC180(36/48/60)1AB	Wiring diagram updated with notes.
DSXC18036AC	Replaced compressors ZPS20K4EPFV230 with ZPS20K5EPFV130 and compressor ZPS30K4EPFV230 with ZPS30K5EPFV130.
DSXC180(48-60)1AC	Ultratech® 2.0 compressor change.

PRODUCT IDENTIFICATION

ASZC16	
AMANA® BRAND SPLIT Z-COMMUNICATING HEAT PUMP R-410A 16 SEER	
Model/Rev	Description
ASZC160**1AA	Introduces Amana® brand 2-stage 16 SEER heat pump units with R-410A, communicating models.
ASZC160(24/36)1AB ASZC160(48/60)1AB	Sanhua (RANCO) reversing valves
ASZC160(24-48)1AC ASZC160601BA	Release of models with accumulators and crankcase heaters.
ASZC160(24-36)]1AD ASZC160601BB	Motor changed to Nidec.
ASZC160(24-36)1AE	Replaced compressors ZPS20K4EPFV230 with ZPS20K5EPFV130 and compressor ZPS30K4EPFV230 with ZPS30K5EPFV130.
ASZC160481AE	Ultratech® 2.0 compressor change.
ASZC160(24/36)1CA ASZC160(48/60)1CA	Replaced compressors with Copeland's UltraTech™ 3 lineup. Transitioned coils to 7mm. Offers improved performance.

ASZC18	
AMANA® BRAND SPLIT Z-COMMUNICATING HEAT PUMPS R-410A 18 SEER	
Model/Rev	Description
ASZC180**1AA	Introduces Amana® brand 2-stage 18 SEER heat pump units with R-410A, communicating models.
ASZC180601BC ASZC180601BB	Ultratech® 2.0 compressor change.
ASZC180(36/48/60)1AB	Release of models with accumulators and crankcase heaters.
ASZC180(36-4)]1AC ASZC180601BA ASZC180361AD	Sanhua (RANCO) reversing valves
ASZC180[24/36/48/60]1CA	Replaced compressors with Copeland's UltraTech™ 3 lineup. Transitioned coils to 7mm. Offers improved performance.

PRODUCT IDENTIFICATION

GSZC16	
GOODMAN® BRAND SPLIT Z-COMMUNICATING HEAT PUMP R-410A 16 SEER	
Model/Rev	Description
GSZC160[24/36/48/60]1CA	Replaced compressors with Copeland's UltraTech™ 3 lineup. Transitioned coils to 7mm. Offers improved performance.

GSZC18	
GOODMAN® BRAND SPLIT Z-COMMUNICATING HEAT PUMP R-410A 16 SEER	
Model/Rev	Description
GSZC180[24/36/48/60]	Replaced compressors with Copeland's UltraTech™ 3 lineup. Transitioned coils to 7mm. Offers improved performance.

ASZC7	
AMANA® BRAND SPLIT Z-COMMUNICATING HEAT PUMP R-410A 17.2 SEER2	
Model/Rev	Description
ASZC70(24/36/48/30)1AA	17.2 SEER 2-Stage HP Development Optimized for 2023 DOE Regulation

GSZC7	
GOODMAN® BRAND SPLIT Z-COMMUNICATING HEAT PUMP R-410A 17.2 SEER2	
Model/Rev	Description
GSZC70(24/36/48/30)1AA	17.2 SEER 2-Stage HP Development Optimized for 2023 DOE Regulation

PRODUCT IDENTIFICATION

DSZC16	
DELUXE SPLIT Z-COMMUNICATING HEAT PUMP R-410A 16 SEER	
Model/Rev	Description
DSZC16**1AA	Initial release of Goodman® brand Deluxe 2-stage 16 SEER heat pump units with R-410A, communicating models.
DSZC160(24/36)1AB DSZC160(48/60)1AB	Sanhua (RANCO) reversing valves.
DSZC160(24-48)1AC DSZC160601BA	Release of models with accumulators and crankcase heaters.
DSZC160(24-48)1AD DSZC160601BB DSZC160481AE DSZC160601BC	Ultratech® 2.0 compressor change.
DSZC160(24-36)1AE	Replaced compressors ZPS20K4EPFV230 with ZPS20K5EPFV130 and compressor ZPS30K4EPFV230 with ZPS30K5EPFV130.

DSZC18	
DELUXE SPLIT Z-COMMUNICATING HEAT PUMP R-410A 18 SEER	
Model/Rev	Description
DSZC18**1AA	Initial release of Goodman® brand Deluxe 2-stage 18 SEER heat pump units with R-410A, communicating models.
DSZC180(36/48/60)1AB	Sanhua (RANCO) reversing valves.
DSZC180361AD	Replaced compressors ZPS20K4EPFV230 with ZPS20K5EPFV130 and compressor ZPS30K4EPFV230 with ZPS30K5EPFV130.
DSZC180(36-48)1AC DSZC180601BA	Release of models with accumulators and crankcase heaters.
DSZC160(24-48)1AD DSZC160601BB	Ultratech® 2.0 compressor change.

AVPTC****14	
SINGLE PIECE AIR HANDLER MULTIPLE-POSITION VARIABLE SPEED PAINTED TXV WITH 4-WIRE COMMUNICATING CONTROL	
Model/Rev	Description
AVPTC183014AA AVPTC313714AA AVPTC426014AA	Initial release of 13 SEER air handler with communicating control and serial communicating indoor blower motor.
AVPTC183014AB AVPTC313714AB AVPTC426014AB	Replaced PCBJA10 communicating air handler control board with PCBJA103.
AVPTC31C14AD	To rate AVPTC/DVPTC31 models to 3Kw heater kit.

PRODUCT IDENTIFICATION

AVPTC**14 SINGLE PIECE AIR HANDLER MULTIPLE-POSITION VARIABLE SPEED PAINTED TXV WITH 4-WIRE COMMUNICATING CONTROL	
MODEL/REV	DESCRIPTION
AVPTC25B14BA AVPTC29B14BA AVPTC31C14BA AVPTC33C14BA AVPTC35B14BA AVPTC37B14BA AVPTC37C14BA AVPTC37D14BA AVPTC39C14BA AVPTC49C14BA AVPTC49D14BA AVPTC59C14BA AVPTC59D14BA AVPTC61D14BA	ECM Based Air Handler with New Comfort Bridge™ Compatible PCB Control Board

AMVT**1400 SINGLE PIECE AIR HANDLER MULTIPLE-POSITION VARIABLE SPEED PAINTED TXV WITH 4-WIRE COMMUNICATING CONTROL	
MODEL/REV	DESCRIPTION
AMVT24BP1400AA AMVT30BP1400AA AMVT36BP1400AA AMVT36CP1400AA AMVT42CP1400AA AMVT48CP1400AA AMVT48DP1400AA AMVT60DP1400AA	VS-ECM Based Air Handler with New Comfort Bridge™ Compatible PCB Control Board, Optimized for 2023 DOE Regulation

MBVC**01 SINGLE PIECE AIR HANDLER MULTIPLE-POSITION VARIABLE SPEED PAINTED TXV WITH 4-WIRE COMMUNICATING CONTROL	
MODEL/REV	DESCRIPTION
MBVC1201 MBVC1601 MBVC2001	ECM Based Air Handler with New Comfort Bridge™ Compatible PCB Control Board

NOTE: This service manual contains AVPTC information for revisions A* & B*. If servicing, pay attention to which PCB board is being used.

PRODUCT IDENTIFICATION

CAUF	
C-INDOOR COIL A-UPFLOW/DOWNFLOW UNCASSED FLOWRATOR	
Model/Rev	Description
CAUF*****6AA	Initial release of CAUF Dayton Upflow/Downflow coils.
CAUF*****6BA	Burr Oak Louvered Fin released in place of the Wavy Fin.
CAUF*****6DA	Replaced existing copper coils and other associated parts with aluminum components.
CAUF*****6DB	Drain pan material changed.
CAUF1824A6RDB CAUF1824B6RDB	Manufacturing Location Change from Dayton to Houston. Designated by "R".
CAUF36***CA	Redesign from 2 row to 3 row for performance improvement.
CAUF3030(A/B)6RDB CAUF3030(C/D)6RDB CAUF3131(B/C)6RDB	Manufacturing Location Change from Dayton to Houston. Designated by "R".
CAUFA*****6A*	Initial Release.
CAUFA*****6B* CAUFA*****6C*	Major revision update for A-Chassis drain port relocation

PRODUCT IDENTIFICATION

CHPF	
C-INDOOR COIL HORIZONTAL A-COIL PAINTED FLOWRATOR	
Model/Rev	Description
CHPF****6AA	Intial release of 13 SEER CHPF horizontal A coil.
CHPF****6BA	Released Burr Oak Louvered Fin in place of the Wavy Fin. The rows changed by one, (i.e. 4 row to 3 row; 3 row to 2 row) where applicable.
CHPF1824A6CA CHPF2430B6CA CHPF3636B6CA CHPF3642C6CA CHPF3642D6CA CHPF3743C6BA CHPF3743D6BA CHPF4860D6DA	Louvered fins. Replaced copper tube hairpins with aluminum hairpins.
CHPF1824A6CB CHPF2430B6CB CHPF3636B6CB CHPF3642C6CB CHPF3642D6CB CHPF3743C6BB CHPF3743D6BB CHPF4860D6DB	Drain pan material change to a Decabromodiphenyl Ether free resin.
CHPF1824A6CC CHPF2430B6CC CHPF3636B6CC CHPF3642C6CC CHPF3642D6CC CHPF3743C6BC CHPF3743D6BC CHPF4860D6DC	Change to prepainted wrappers

PRODUCT IDENTIFICATION

CAPF	
C-INDOOR COIL A-UPFLOW/DOWNFLOW PAINTED FLOWRATOR	
Model/Rev	Description
CAPF*****6AA	Initial release of CAPF Dayton Upflow/Downflow coils.
CAPF*****6BA	Burr Oak Louvered Fin released in place of the Wavy Fin.
CAPF36***CA	Redesigned for performance improvement from 2 row to 3 row.
CAPF*****6DA	Replaced existing copper coils and other associated parts with aluminum components.
CAPF*****6DB	Drain pan material changed
CAPF1824A6DC CAPF1824B6DC CAPF1824C6DC CAPF3030A6DC CAPF3030B6DC CAPF3030C6DC CAPF3030D6DC CAPF3131B6DC CAPF3131C6DC CAPF3137B6AB CAPF3636A6DC CAPF3636B6DC CAPF3636C6DC CAPF3636D6DC CAPF3642C6DC CAPF3642D6DC CAPF3743C6DC CAPF3743D6DC CAPF4860C6DC CAPF4860D6DC CAPF4961C6DC CAPF4961D6DC	Redesign the wrapper for the CAPF to provide increased ease of installation.
CAPFA1818B6A CAPFA1818B6A	Cased Uncased 7mm AL Coils. Replaced 3/8 aluminum tubing in residential splits indoor coils with more efficient 7mm aluminum tubing.
CAPFA*****6A*	Initial Release
CAPFA*****6B*	Major revision update for A-chassis drain port relocation
CAPFA*****6C*	

PRODUCT IDENTIFICATION

CAPT	
C-INDOOR COIL A-UPFLOW/DOWNFLOW PAINTED CASED FLOWRATOR W/TXV	
Model/Rev	Description
CAPT3131B4BA CAPT3131C4BA	Initial release of coils with factory-installed, non-adjustable TXV. Single stage AHRI ratings for CAPT3131 NTC combinations.
CAPT3743C4AA CAPT3743D4AA	Initial release of single stage AHRI ratings for CAPT3743 NTC combinations.
CAPT4961C4AA CAPT4961D4AA	Initial release of single stage AHRI ratings for CAPT4961C4 NTC combinations.
CAPT3131B4AB CAPT3131C4AB CAPT3743C4AB CAPT3743D4AB CAPT4961C4AB CAPT4961D4AB	Redesign the wrapper for the CAPT to provide increased ease of installation.

CSCF	
C-INDOOR COIL S-HORIZONTAL SLAB COIL C-UNPAINTED FLOWRATOR	
Model/Rev	Description
CSCF****6AA	Initial release of 13 SEER CSCF horizontal slab coils.
CSCF****6BA	Burr Oak Louvered Fin released in place of the Wavy Fin. Rows reduced by one where applicable.
CSCF1824N6BB CSCF3036N6BB CSCF3642N6CB CSCF4860N6CB	Drain pan material changed.
CSCF1824N6CA CSCF3036N6CA CSCF3642N6CA CSCF4860N6CA	Replaced copper coils and other associated parts with aluminum components.

SYSTEM OPERATION

COMMUNICATING SYSTEM

The communicating platform is a system that includes a communicating air handler/furnace/modular blower and air conditioner or heat pump. Any other system configurations are considered traditional (or legacy) system.

A **communicating** heating/air conditioning system differs from a legacy/traditional system in the manner in which the indoor unit, outdoor unit and thermostat interact with one another. In a traditional system, the thermostat sends commands to the indoor and outdoor units via analog 24 VAC signals. It is a one-way communication path in that the indoor and outdoor units typically do not return information to the indoor board.

On the other hand, the indoor unit and outdoor system “communicate” digitally with one another. It is now a two-way communications path. The thermostat still sends commands to the indoor and outdoor units. However, the indoor board may also request and receive information from the outdoor unit. This information may be displayed on the Cool Cloud HVAC app.

AIRFLOW CONSIDERATIONS

Airflow demands are managed different in a fully communicating system than they are in a legacy wired system. The system operating mode (as determined by the thermostat) determines which unit calculates the system airflow demand. If the indoor unit is responsible for determining the airflow demand, it calculates the demand and sends it to the ECM motor. If the outdoor unit or thermostat is responsible for determining the demand, it calculates the demand and transmits the demand along with a fan request to the indoor unit. The indoor unit then sends the demand to the ECM motor. The following table lists the various communicating systems, the operating mode, and airflow demand source.

For example, assume the system is an air conditioner matched with an air handler. With a call for low stage cooling, the air conditioner will calculate the system’s low stage cooling airflow demand. The air conditioner will then send a fan request along with the low stage cooling airflow demand to the air handler. Once received, the air handler will send the low stage cooling airflow demand to the ECM motor. The ECM motor then delivers the low stage cooling airflow. The table below lists the nominal high and low stage airflow for the communicating air conditioners and heat pumps.

Models	Cooling		Heating	
	High	Low	High	Low
*SZC160241	800	600	800	600
*SZC160361	1200	800	1200	800
*SZC160481	1550	1100	1550	1100
*SZC160601	1800	1210	1800	1210
*SZC180241	850	550	850	550
*SZC180361	1250	850	1250	850
*SZC180481	1750	1210	1750	1210
*SZC180601	1750	1210	1750	1210
*SZC70241	800	560	800	560
*SZC70361	1200	840	1200	840
*SZC70481	1600	1120	1600	1120
*SZC70601	1890	1323	1890	1323

CONTROL WIRING

NOTE: Refer to section Electrical Connections - High Voltage Connections for 208/230 volt line connections to the air conditioner or heat pump.

NOTE: A removable plug connector is provided with the control to make thermostat wire connections. This plug may be removed, wire connections made to the plug, and replaced. It is strongly recommended that you do not connect multiple wires into a single terminal. Wire nuts are recommended to ensure one wire is used for each terminal. Failure to do so may result in intermittent operation.

Typical 18 AWG thermostat wire may be used to wire the system components. 100 feet is the maximum length of wire recommended between indoor unit and outdoor unit, or between indoor unit and thermostat.

NOTE: It is highly recommended that the fault history be cleared.

SYSTEM OPERATION

Occasionally the need to trouble-shoot the network may arise. The integrated air handler control has some on-board tools that may be used to troubleshoot the network. These tools are: red communications LED, green receive (Rx) LED, and learn button. Refer to the Communications Troubleshooting Chart and Air Handler Diagnostic Codes below for error codes, possible causes and corrective actions.

- Red Communications LED - Indicates the status of the network. The table below indicates the LED status and the corresponding potential problem.
- Green Receive Communication LED - Indicates network traffic. The table below indicates the LED status and the corresponding potential problem.
- Learn Button - Used to reset the network. Depress the button for approximately 2 seconds to reset the network.

COMMUNICATIONS TROUBLESHOOTING CHART

LED	LED Status	Indication	Possible Causes	Corrective Action(s)	Notes & Cautions
Green Receive LED	Off	<ul style="list-style-type: none"> • No Power • Communications error 	<ul style="list-style-type: none"> • No power to air handler • Open fuse • Communications error 	<ul style="list-style-type: none"> • Check fuses and circuit breakers; replace/reset • Replace blown fuse • Check for shorts in low voltage wiring in air handler/system • Reset network by depressing learn button • Check data 1/data 2 voltages 	<ul style="list-style-type: none"> • Turn power OFF prior to repair
Communicating	Rapid Flashing	<ul style="list-style-type: none"> • Normal network traffic 	<ul style="list-style-type: none"> • Control is "talking" on network as expected 	<ul style="list-style-type: none"> • None 	<ul style="list-style-type: none"> • None

SYSTEM OPERATION

COOLING

The refrigerant used in the system is R-410A. It is a clear, colorless, non-toxic and non-irritating liquid. R-410A is a 50:50 blend of R-32 and R-125. The boiling point at atmospheric pressure is -62.9°F.

A few of the important principles that make the refrigeration cycle possible are: heat always flows from a warmer to a cooler body. Under lower pressure, a refrigerant will absorb heat and vaporize at a low temperature. The vapors may be drawn off and condensed at a higher pressure and temperature to be used again.

The indoor evaporator coil functions to cool and dehumidify the air conditioned spaces through the evaporative process taking place within the coil tubes.

NOTE: The pressures and temperatures shown in the refrigerant cycle illustrations on the following pages are for demonstration purposes only. Actual temperatures and pressures are to be obtained from the “Expanded Performance Chart”.

Liquid refrigerant at condensing pressure and temperatures, (270 psig and 122°F), leaves the outdoor condensing coil through the drier and is metered into the indoor coil through the metering device. As the cool, low

pressure, saturated refrigerant enters the tubes of the indoor coil, a portion of the liquid immediately vaporizes. It continues to soak up heat and vaporizes as it proceeds through the coil, cooling the indoor coil down to about 48°F.

Heat is continually being transferred to the cool fins and tubes of the indoor evaporator coil by the warm system air. This warming process causes the refrigerant to boil. The heat removed from the air is carried off by the vapor.

As the vapor passes through the last tubes of the coil, it becomes superheated. That is, it absorbs more heat than is necessary to vaporize it. This is assurance that only dry gas will reach the compressor. Liquid reaching the compressor can weaken or break compressor valves.

The compressor increases the pressure of the gas, thus adding more heat, and discharges hot, high pressure superheated gas into the outdoor condenser coil.

In the condenser coil, the hot refrigerant gas, being warmer than the outdoor air, first loses its superheat by heat transferred from the gas through the tubes and fins of the coil. The refrigerant now becomes saturated, part liquid, part vapor and then continues to give up heat until it condenses to a liquid alone. Once the vapor is fully liquefied, it continues to give up heat which subcools the liquid, and it is ready to repeat the cycle.

COOLING CYCLE

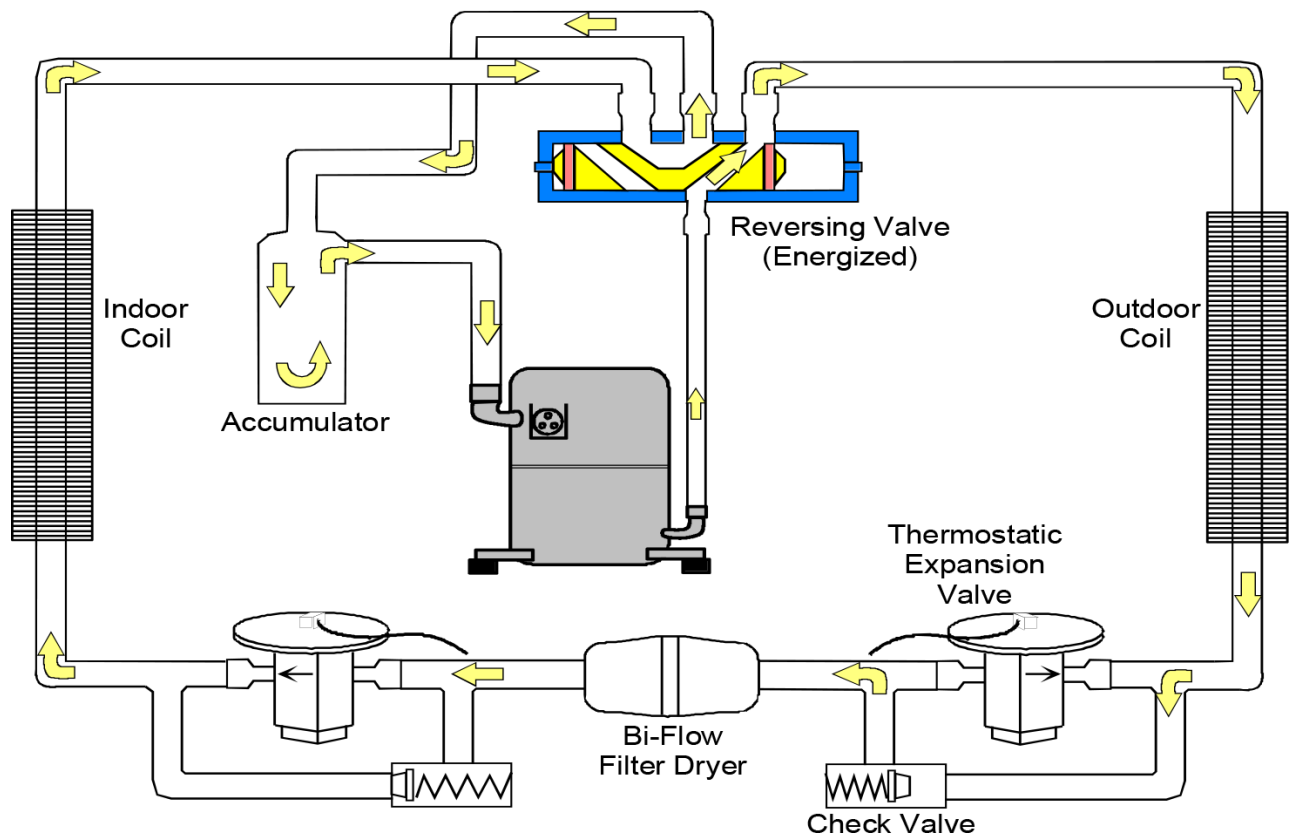

SYSTEM OPERATION

HEATING

The heating portion of the refrigeration cycle is similar to the cooling cycle. By energizing the reversing valve solenoid coil, the flow of the refrigerant is reversed. The indoor coil now becomes the condenser coil, and the outdoor coil becomes the evaporator coil.

The check valve at the indoor coil will open by the flow of refrigerant letting the now condensed liquid refrigerant bypass the indoor expansion device. The check valve at the outdoor coil will be forced closed by the refrigerant flow, thereby utilizing the outdoor expansion device.

DEFROST CYCLE - COMMUNICATING MODELS

The defrosting of the outdoor coil is jointly controlled by the UC PCB and the outdoor coil temperature (OCT) sensor.

The OCT sensor is clamped to a feeder tube entering the outdoor coil. Defrost timing periods of 30, 60, 90 or 120 minutes may be selected via the dipswitch settings on the UC PCB. During operation, if the coil temperature is low enough (approximately 31° F), the microprocessor will accumulate the compressor run time. When the total compressor run time reaches 30, 60, 90 or 120 minutes, and there is a call for heat, the PCB will initiate a defrost cycle.

When the microprocessor detects the coil temperature to be high enough (approximately 75 OF), or 10 minutes of maximum defrost cycle time has elapsed, whichever occurs first, the defrost cycle is terminated and the timing period is reset. The field service personnel can also advance a heat pump to the defrost cycle by simultaneously pressing the "TEST" button and the "RECALL" button on the UC board.

Use the dipswitches to select defrost time interval (30, 60, 90 or 120 minutes) See chart below.

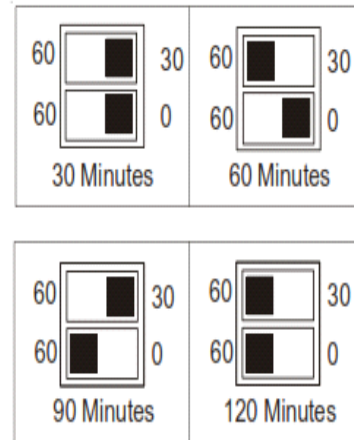

Dipswitch Settings for Selection of Defrost Time

HEATING CYCLE

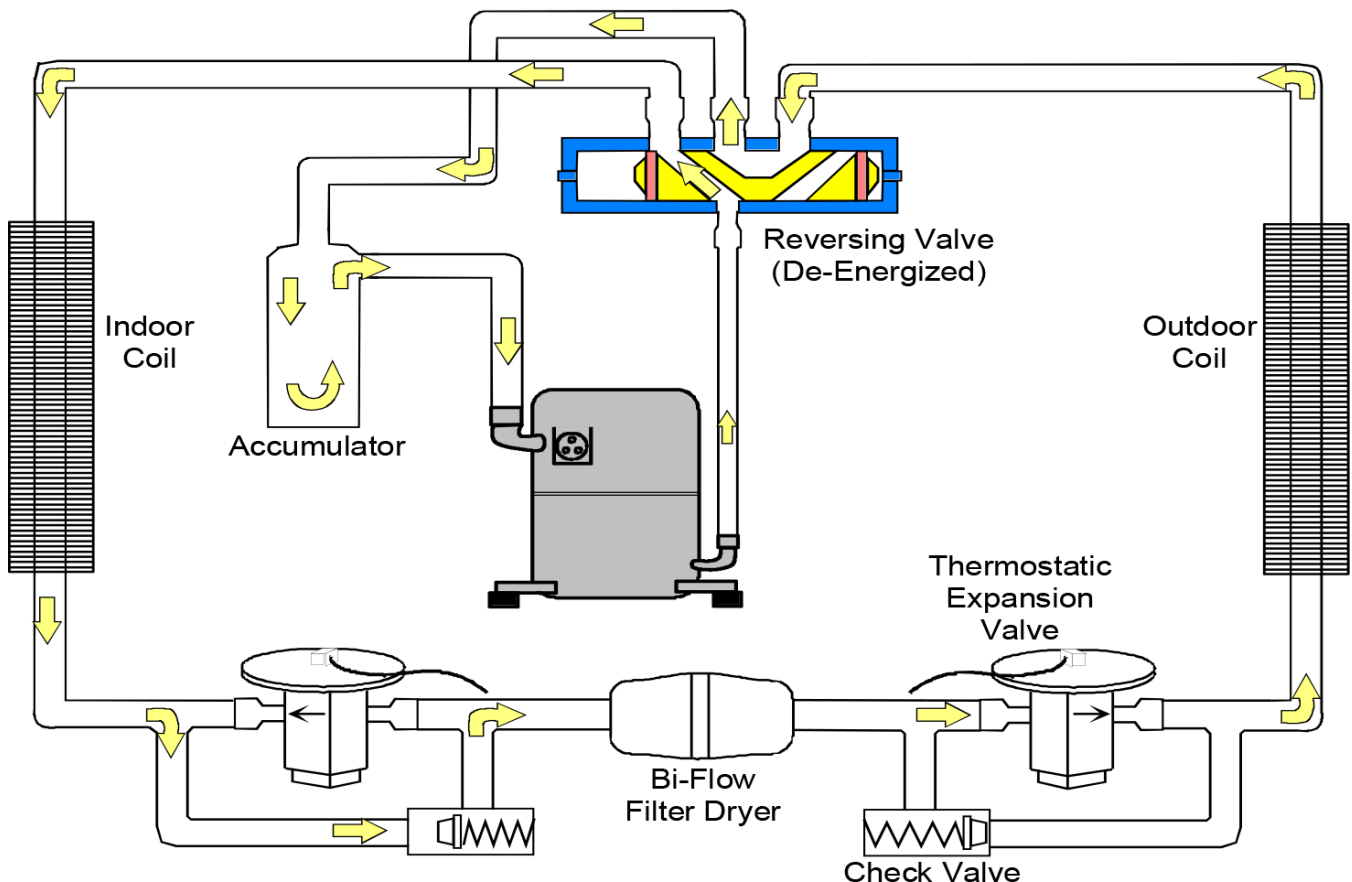

SYSTEM OPERATION

REVERSING VALVE

With a heat pump the reversing valve can leak. Discharge gases can leak into the suction inside the valve. Compound gages will give the same symptoms as bad compressor valves. The temperature between true suction and the suction line after the valve should not be greater than 4 degrees.

TROUBLESHOOTING THE REVERSING VALVE FOR ELECTRICAL FAILURE

1. Place unit into the cooling mode. Test for 24 volts at the solenoid. If there is no voltage present at coil, check the control voltage.
2. If voltage is present, loosen the nut on the top of the coil. Remove the coil, there should be slight resistance.
3. If the slight resistance is felt, remove the coil. As you remove the coil listen carefully, an audible click should be detected. The clicking is due to the movement of the pilot valve plunger. The absence of a clicking sound indicates the plunger is stuck.

TROUBLESHOOTING MECHANICAL FAILURES ON A REVERSING VALVE BY PRESSURE

1. Troubleshooting the reversing valve can be done by pressure and touch.
2. Raise the head pressure. In the cooling mode block the fan exhaust. Once head pressure has been raised, cycle between cooling and heating and see if the piston can be freed.

TROUBLE SHOOTING MECHANICAL FAILURES ON A REVERSING VALVE BY TEMPERATURE

1. When operating properly the valve contains refrigerant gases at certain temperatures.
2. The discharge line should be the same temperature after the valves discharge line.
3. The true suction should be the same as the suction line after the valve. If there is a 4-degree difference, the valve is leaking.

EXPANSION VALVE/CHECK VALVE ASSEMBLY
IN COOLING OPERATION

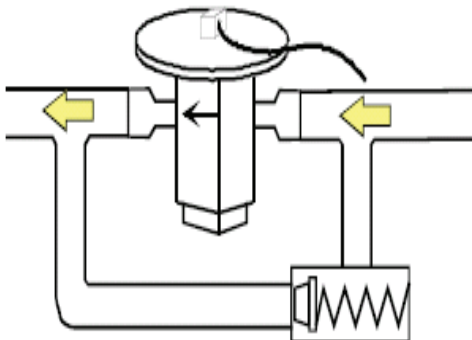

EXPANSION VALVE/CHECK VALVE ASSEMBLY
IN HEATING OPERATION

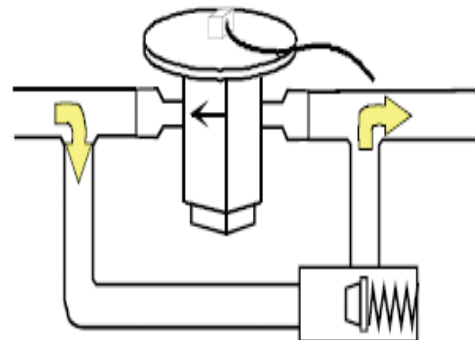

Most expansion valves used in current Goodman/Amana® Brand Heat Pump products use an internally checked expansion valve.

This type of expansion valve does not require an external check valve as shown above. However, the principle of operation is the same.

SYSTEM OPERATION

SEQUENCE OF OPERATION

AVPTC/DSXC CONDENSER

The AVPTC air handler matched with an ASXC or GSXC condensing unit constitutes a communicating network. The two components, or subsystems, making up the system communicate with one another with information passed between both components.

NOTE: The individual subsystems will cease operation if the request for operation is NOT refreshed after 5 minutes. This is a built-in safe guard to prevent the possibility of runaway operation.

1.0 COOLING OPERATION - LOW AND HIGH STAGE COOL

1.1 The thermostat sends a 24VAC Y signal to the control requesting cooling. The internal control algorithms will then send a request for low stage cooling through the network to the unitary (UC) control in the condenser. The UC control receives the command and processes any compressor and fan delays. **NOTE: The main control algorithm might start with a high stage cooling call and skip the low stage step if necessary.**

1.2 The UC control sends a request for low stage fan speed to the air handler/modular blower. The blower energizes the ECM blower motor at the appropriate speed.

1.3 The condenser energizes the compressor and condenser fan motor at the appropriate low stage speeds.

1.4 The system operates at low stage cooling.

1.5 If the thermostat demand cannot be met on low stage cooling, the internal algorithm of the board takes over and sends a request for high stage cooling to the condenser. The condenser in turn sends a request for high stage fan speed to the air handler/modular blower. The blower increases the blower speed to the high stage cooling speed.

1.6 The condenser's unitary control energizes the high stage compressor solenoid and switches the condenser fan motor to high speed.

1.7 The system operates at high stage cooling.

1.8 Once the thermostat demand is satisfied, the thermostat commands the UC control to end cooling operation. The condenser de-energizes the compressor and condenser fan motor. The UC control continues providing a fan request until any cooling blower OFF delays have expired.

NOTE: The only time auxiliary/emergency heat can be utilized is when the system is connected legacy and a heat pump thermostat is utilized.

2.0 HEATING OPERATION - AUXILIARY/EMERGENCY HEAT

2.1 The thermostat sends a request for emergency heat to the air handler.

2.2 The air handler control energizes the ECM blower motor at the emergency heat speed. The electric heat sequencer outputs are also energized, thus energizing the electric heaters.

2.3 The system operates at emergency heat.

2.4 Once the thermostat demand is satisfied, the thermostat commands the air handler to end emergency heat operation. The air handler control de-energizes the electric heat sequencer outputs. The ECM blower motor remains energized until any blower OFF delay timing has expired.

3.0 CONTINUOUS FAN OPERATION

3.1 With a demand for continuous fan operation, the thermostat sends a fan request (24VAC G signal) to the integrated air handler. The control energizes the variable speed ECM motor at fan demand based on the menu setting. The fan demand provided by the thermostat will range between 30% and 100% of the air handler's maximum airflow capability.

3.2 If the thermostat demand for continuous fan is removed, the integrated AH control immediately de-energizes the ECM blower motor.

AVPTC/DSZC HEAT PUMP AND CTK0* COMMUNICATING THERMOSTAT

The AVPTC matched with an ASZC or DSZC condensing unit wired in 1 and 2 between the indoor and outdoor constitute a communicating system. The three components, or subsystems, making up the system communicate with one another with information passed between the two components. This leads to a somewhat non-traditional manner in which the system components receive commands for system operation. All system commands are routed from the component through the network to the appropriate destination component.

NOTE: Communicating heat pump systems are designed to utilize a balance point temperature. The balance point temperature in part controls heat pump operation. If the outdoor temperature is below the balance point, the heat pump is disable and only electric heat is available for heating. The balance point temperature is set via the CoolCloud HVAC app or utilizing the push buttons on the indoor board.

SYSTEM OPERATION

The CoolCloud HVAC app also allows the user to disable the electric heaters in the air handler depending on the outdoor temperature. The electric heaters are disabled if the outdoor temperature is above the set point. All heating is supplied by the heat pump.

The outdoor air temperature is acquired from the outdoor air temperature (OAT) sensor included with the ASZC/DSZC heat pump models. Faults with the sensor will affect heating operation.

1.0 HEATING OPERATION

OUTDOOR TEMPERATURE ABOVE THE HEAT PUMP BALANCE POINT

1.1 The ComfortBridge control algorithm sends a request for the outdoor air temperature to the heat pump. The heat pump returns an outdoor air temperature that is above the balance point temperature. Heat pump heating is enabled as mentioned above, even if the temperature is above the balance point, the internal algorithms might still have determined the heat pump isn't capable of getting the job done. If this is the case, the heat pump will not be active until the algorithm resets.

1.2 The ComfortBridge control algorithm sends a request for low stage heat pump heating to the unitary (UC) control in the heat pump. The UC control receives the command and processes any compressor and fan delays.

NOTE: The main control algorithm might start with a high stage heating call and skip the low stage step if necessary.

1.3 The UC control sends a request for low stage fan speed to the air handler/modular blower. The blower energizes the ECM blower motor at the appropriate speed.

1.4 The condenser energizes the compressor and condenser fan motor at the appropriate low stage speeds.

1.5 The system operates at low stage heat pump heating.

1.6 If the thermostat demand cannot be met on low stage heat pump heating. The heat pump in turn sends a request for high stage fan speed to the air handler. The AH control increases the blower speed to the high stage heat pump heating speed.

1.7 The heat pump's unitary control energizes the high stage compressor solenoid and switches the condenser fan motor to high speed.

1.8 The system operates at high stage heat pump heating.

1.9 If the thermostat demand cannot be met on high stage heat pump heating.

1.10 Upon receiving a demand for auxiliary heat, the air handler control determines the appropriate airflow for high stage heat pump + auxiliary heat operation and operates the ECM blower motor at that airflow demand. The air handler control determines which airflow demand is greatest and applies that demand when operating the ECM blower motor.

1.11 The system operates at high stage heat pump heating plus auxiliary heat.

1.12 Once the thermostat demand is satisfied, the ComfortBridge control algorithm commands the heat pump to end heat pump heating operation. The compressor and outdoor fan motor are de-energized.

The air handler is commanded to end auxiliary heat operation. The air handler control de-energizes the electric heat sequencer outputs. The ECM blower motor remains energized until any blower OFF delay timing has expired.

2.0 OUTDOOR TEMPERATURE BELOW THE HEAT PUMP BALANCE POINT

2.1 The indoor board sends a request for the outdoor air temperature to the heat pump. The heat pump returns an outdoor air temperature that is below the balance point temperature. Heat pump heating is disabled.

2.2 The outdoor board sends a request for auxiliary heat to the air handler.

2.2 The air handler control energizes the ECM blower motor at the auxiliary heat speed. The electric heat sequencer outputs are also energized, thus energizing the electric heaters.

2.3 The system operates at auxiliary heat.

2.4 Once the thermostat demand is satisfied, the ComfortBridge control algorithm commands the air handler to end auxiliary heat operation. The air handler control de-energizes the electric heat sequencer outputs. The ECM blower motor remains energized until any blower OFF delay timing has expired.

SYSTEM OPERATION

3.0 DEFROST OPERATION

3.1 While the system is operating in heat pump heating (**see 2.0 Heating Operation**), the control in the outdoor unit may determine that a defrost cycle is needed. Upon determining that a defrost cycle is needed, the UC control de-energizes the condenser fan motor and energizes the reversing valve.

3.2 The compressor may be de-energized for a short delay during the reversing valve shift. (The delay period is adjustable via the CoolCloud HVAC app or the push buttons on the indoor board. The compressor delay is intended to eliminate compressor noise during the reversing valve shift.) The compressor will energize (or re-energize) at high stage.



3.3 The UC control sends a request for defrost operation to the integrated air handler control. The air handler control energizes the electric heat sequencer outputs and operates the ECM blower motor at the electric heat speed.

3.4 Once the defrost cycle is terminated, the heat pump commands the air handler/modular blower to end defrost operation.

3.5 The system returns to heat pump heating operation that was in effect prior to the defrost cycle.

SERVICING

CHECKING VOLTAGE

 WARNING
<p>HIGH VOLTAGE! DISCONNECT ALL POWER BEFORE SERVICING OR INSTALLING. MULTIPLE POWER SOURCES MAY BE PRESENT. FAILURE TO DO SO MAY CAUSE PROPERTY DAMAGE, PERSONAL INJURY OR DEATH.</p> 

1. Remove doors, control panel cover, etc. from unit being tested.

With power ON:



 WARNING
<p>LINE VOLTAGE NOW PRESENT.</p>

2. Using a voltmeter, measure the voltage across terminals L1 and L2 of the contactor for single phase units, and L3, for 3 phase units.
3. No reading - indicates open wiring, open fuse(s) no power or etc. from unit to fused disconnect service. Repair as needed.
4. If incoming voltage is within the range listed in the chart below, energize the unit.
5. Using a voltmeter, measure the voltage with the unit starting and operating to determine if voltage is within the range listed in the chart below.
6. If the voltage falls below the minimum voltage, check the line wire size. Long runs of undersized wire can cause low voltage. If the wire size is adequate, notify the local power company regarding either low or high voltage.

Unit Supply Voltage		
Voltage	Min.	Max.
208/230	198	253

NOTE: When operating electric heaters on voltages other than 240 volts, refer to the System Operation section on electric heaters to calculate temperature rise and air flow. Low voltage may cause insufficient heating.

CHECKING WIRING

 WARNING
<p>HIGH VOLTAGE! DISCONNECT ALL POWER BEFORE SERVICING OR INSTALLING. MULTIPLE POWER SOURCES MAY BE PRESENT. FAILURE TO DO SO MAY CAUSE PROPERTY DAMAGE, PERSONAL INJURY OR DEATH.</p> 

1. Check wiring visually for signs of overheating, damaged insulation and loose connections.
2. Use an ohmmeter to check continuity of any suspected open wires.
3. If any wires must be replaced, replace with comparable gauge and insulation thickness.

COMFORTBRIDGE™ TECHNOLOGY AIR HANDLER (B*)

AVPTC MOTOR ORIENTATION

If the unit is in the upflow position, there is no need to rotate the motor. If the unit is in the downflow position, loosen motor mount and rotate motor as shown in the AVPTC Motor Orientation figure below. Be sure motor is oriented with the female connections on the casing down. If the motor is not oriented with the connections down, water could collect in the motor and may cause premature failure.

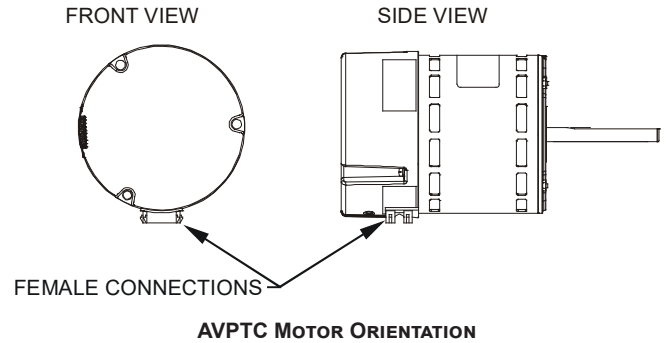

COOL CLOUD HVAC PHONE APPLICATION

Actual screens may look different based on the mobile device being used.

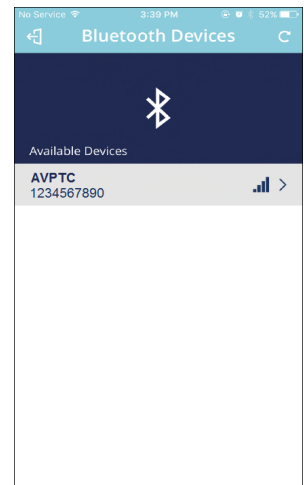
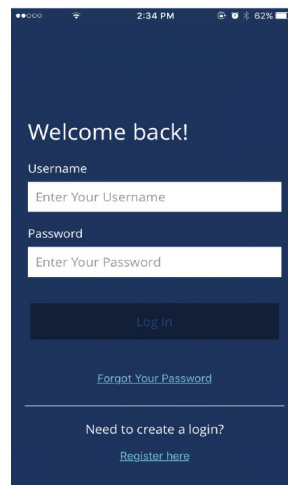

SERVICING

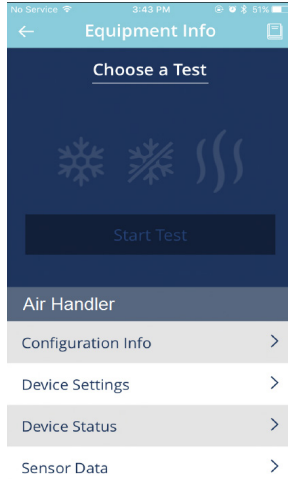

This air handler is Bluetooth ready and functions with the Cool Cloud HVAC phone application designed to improve the contractor's setup / diagnostic experience. Users can see specific model information, review active diagnostic error codes, observe system menu testing of all operational modes (heat / cool / fan) directly from the phone. The phone application is also capable of directly updating the air handler software anytime updates are available. The application will automatically notify the user.

NOTE: The software update may take up to 20 minutes to complete.

QUICK START GUIDE FOR COMMUNICATING OUTDOOR UNITS

EXTREMELY IMPORTANT: For all cooling calls the system only requires a single Y input from the thermostat. For all heating calls (including applications with backup electric heater kits) the system only requires a single W input from the thermostat. Internal algorithms will control all available cooling and heating stages based on these inputs. Any single-stage 24VAC thermostat can be used. For proper operation, the thermostat must be setup to control a single stage AC outdoor unit and to control single stage electric heat operation. The control board does not accommodate an O wire thermostat input (reversing valve signal). If a heat pump is installed, the thermostat should be setup as stated above. Setting the thermostat for the heat pump control or multistage control may result in incorrect performance.

1. Connect all necessary thermostat wires to the thermostat connector on the air handler control as instructed by the applicable wiring diagrams shown in this section.
2. Connect the 1 & 2 wires between the indoor and outdoor unit for communicating operation.

Note: Verify two stage outdoor units include a 24VAC transformer (for outdoor control board power). Two stage outdoor units may not behave properly without this 24 VAC transformer.

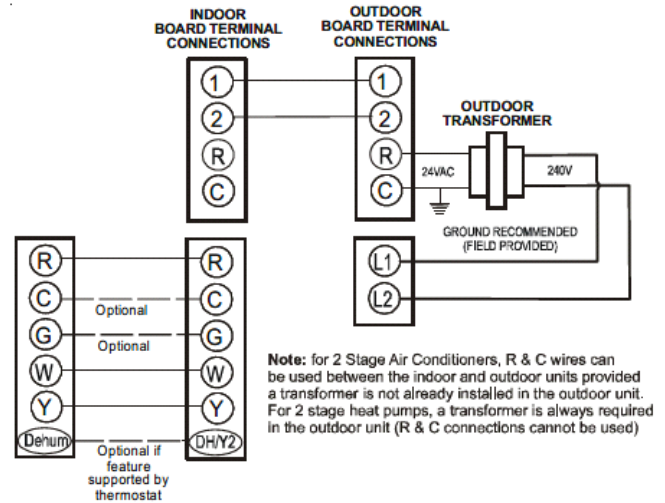

COMMUNICATING TWO STAGE AIR CONDITIONER OR HEAT PUMP

3. Download the Cool Cloud HVAC phone application for charging and to configure /test system.

NOTE: When new versions of Bluetooth Communication Software and Air Handler Control Software are available, the phone application notifies the user. Software updates are classified as either optional or mandatory and installed by using the phone application. Ensure all mandatory software updates and install if necessary.

CHARGING

1. Two-stage outdoor units using the Cool Cloud HVAC application:
 - A. Using the cooling icon after entering the outdoor unit menus, energize the outdoor unit to 49% capacity or lower.
 - B. Charge the outdoor unit as required using the charging information provided with the outdoor equipment.

QUICK START GUIDE FOR NON-COMMUNICATING OUTDOOR UNITS

EXTREMELY IMPORTANT: For two stage electric heat kit control the system only needs a single W input. Internal algorithms will control staging automatically based on the single W input. For non-communicating outdoor unit wiring, see instructions below:

1. Use the wiring diagrams on the next page to connect low voltage thermostat wires.

NOTE: When installing the air handler with a non-communicating heat pump, wire directly to the "O" terminal on the non-communicating heat pump. See the following figures.

SERVICING

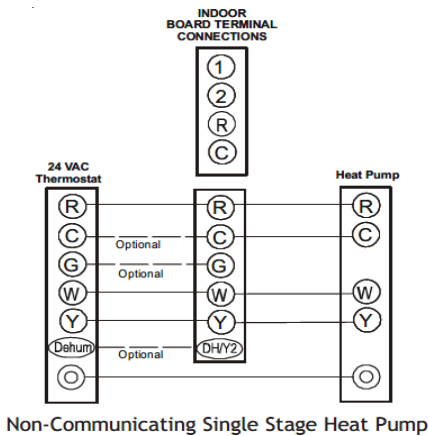
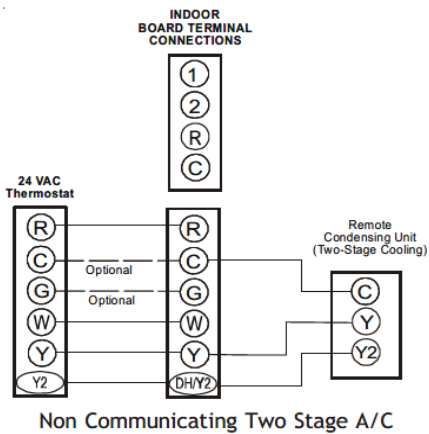
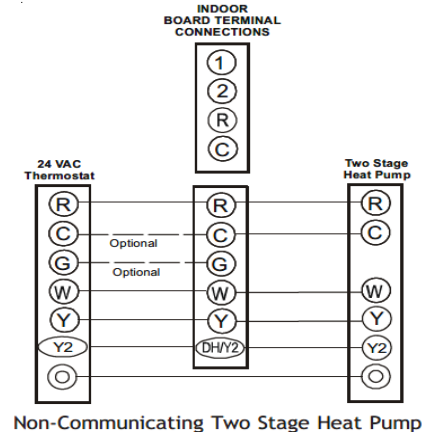
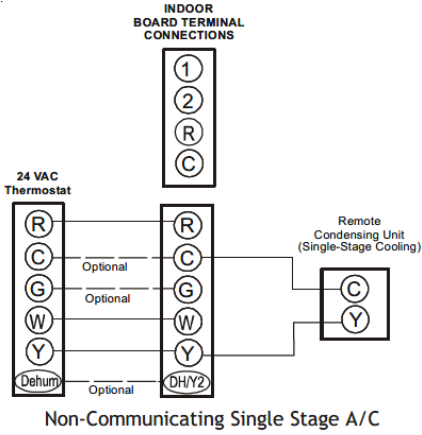

- Download the Cool Cloud HVAC phone application.

NOTE: When new versions of Bluetooth Communication Software and Air Handler Control Software are available, the phone application notifies the user. Software updates are classified as either optional or mandatory and installed by using the phone application. Ensure all mandatory software updates have been installed. Review notes for optional software updates and install if necessary.

- Go to the Non-Comm Outdoor Setting Menu (0d5) using the on board push buttons or the Cool Cloud HVAC phone application. Select “1AC” for single stage Air Conditioners, “1HP” for single stage Heat Pumps, “2AC” for two stage Air Conditioners and “2HP” for 2 stage Heat Pumps.
- Go to the Tonnage Units Menu (ton) and select the tonnage value that corresponds to the desired airflow for the outdoor unit. See the following table.

NOTE: For the two stage non-communicating outdoor units, system will stage airflow automatically for low stage operation.

NOTE: The system will not provide airflows above the max Airflow Value.

- Use the Cool Cloud HVAC phone application to configure/test air handler operations.

NOTE: The phone application cannot test a non-communicating outdoor unit. The thermostat will be required for outdoor unit testing.

Single-stage outdoor units:

- Provide a cooling call from the thermostat and charge accordingly.

ELECTRIC HEATER KIT TESTING

- Select the electric heat icon after entering the air handler menus while using the Cool Cloud phone application.

SERVICING

2. Select any value less than 50% for low stage operation and any value greater than 50% for high stage operation.
3. Confirm thermostat heating and cooling calls function properly for high stage operation.

DEHUMIDIFICATION

Dehumidification allows the air handler's circulator blower to operate at a reduced speed during a combined thermostat call for cooling and a dehumidification call from the thermostat or humidistat. This lower blower speed increases dehumidification of the conditioned air as it passes through the indoor coil. The control board is equipped with a 24 volt dehumidification input (DH) located on the thermostat wiring connector. The terminal can be configured to enable dehumidification when the input is energized or de-energized. When using an external dehumidistat, connect it between the R and DH terminals. If the humidistat closes on humidity rise or the thermostat energizes this terminal when dehumidification is required, set the control board Dehum Logic Menu (dHL) to "HI" using the push buttons or Cool Cloud HVAC phone application. If the humidistat opens on humidity or the thermostat de-energizes this terminal when dehumidification is required, set the Dehum Logic Menu to "Lo" using the push buttons or Cool Cloud HVAC phone application.

AUXILIARY ALARM SWITCH

The control is equipped with a 24VAC Aux Alarm to be used for a condensate switch install (designated by CONDENSATE IN/OUT on the control). By default, the connected AUX switch is normally closed and opens when the water level in the evaporator coil base pan reaches an undesirable level. The control responds by displaying a "E0F" error code and turning off the outdoor condensing unit. If the AUX switch is detected to be in the closed position for 30 seconds, normal operation resumes and the error message is no longer displayed.

START-UP PROCEDURE

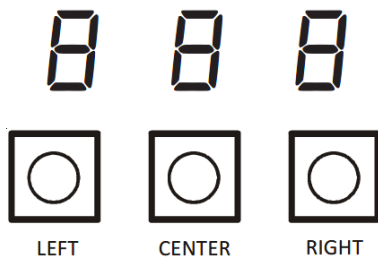

The air handler includes three on-board push buttons allowing users to navigate indoor and outdoor system menus. The Right and Left buttons allow the user to scroll through the main menus and to then scroll through available options within specific menus. The Center button is used to enter into a main menu and to then permanently select options within those menus.

NOTE: After scrolling to the desired option within a menu, that option may be flashing on the 7-segment displays. This indicates the option has not been officially selected. Pressing the Center button two times will select that option. The first press will stop the flashing. The second will make the selection official and return you to the main menu.

ACCESSORY CONTROL (HUMIDIFIERS, DEHUMIDIFIERS, VENTILATORS)

If an external humidifier, dehumidifier or ventilator is installed, it may require airflow from the HVAC system to function properly.

1. Make sure the installed 24VAC thermostat is capable of controlling the accessory or accessories.
2. Connect the appropriate accessory control wires to the accessory devices from the thermostat (see thermostat manual for connection and setup instructions).
3. If the thermostat is capable of providing a continuous fan call (G signal) during accessory operation:

Make sure to connect the thermostat G terminal to the G terminal on the indoor unit. Setup thermostat to ensure G signal is energized during accessory operation.

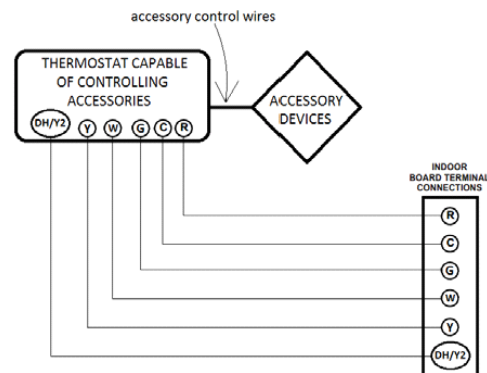

4. Select the appropriate fan only airflow for the accessory using the indoor unit push button menus or the Cool Cloud HVAC phone application.
5. Using the thermostat, independently test each accessory in addition to the independently testing continuous fan mode.

SERVICING

Dehumidification Control Options

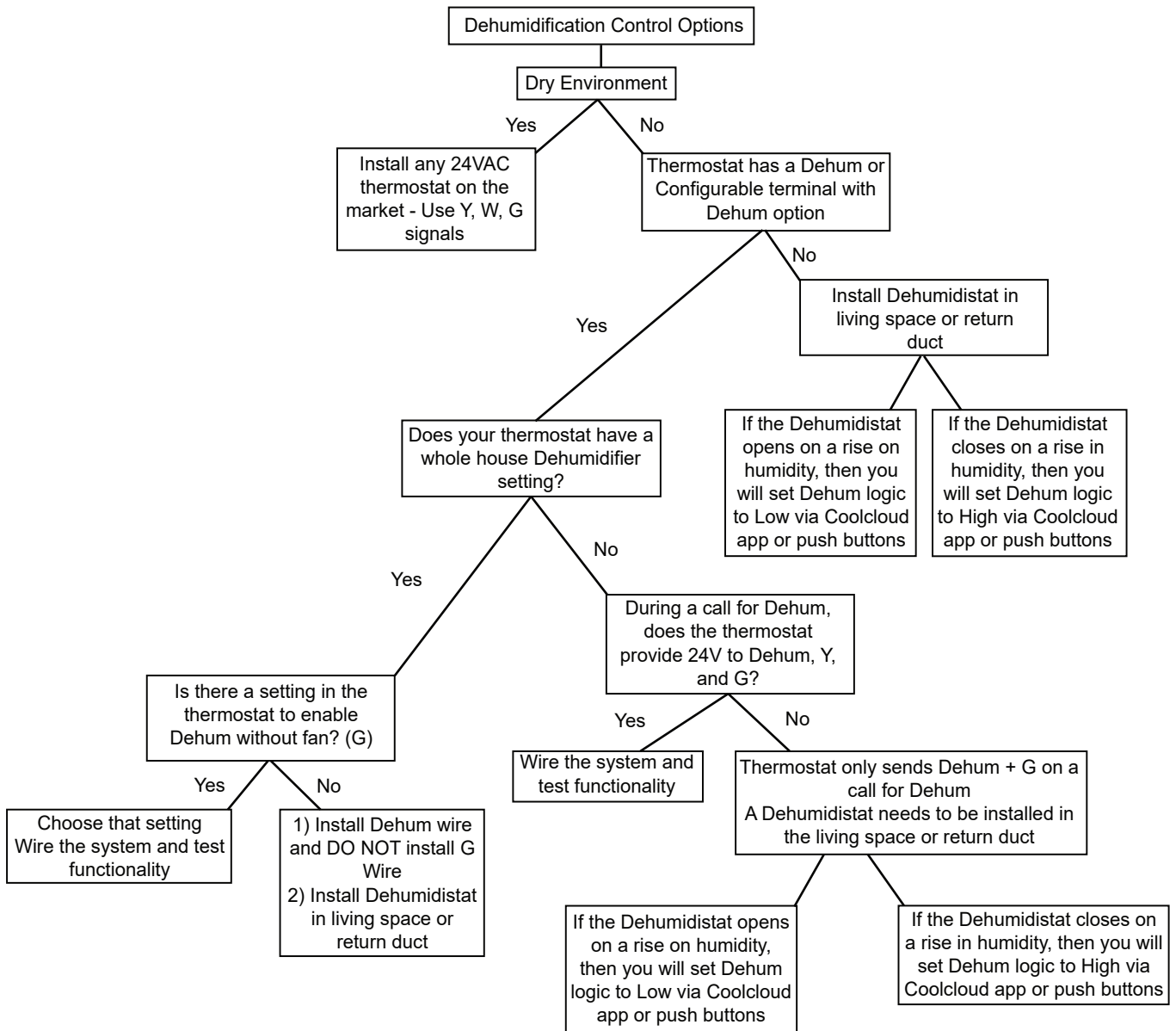

Key Mitigations:

1. Full featured TS (dehum & overcool)
2. Connect G and dehum wire correctly
3. Dehumidistat



SERVICING

CHECKING TRANSFORMER AND CONTROL CIRCUIT

 WARNING
<p>HIGH VOLTAGE! DISCONNECT ALL POWER BEFORE SERVICING OR INSTALLING. MULTIPLE POWER SOURCES MAY BE PRESENT. FAILURE TO DO SO MAY CAUSE PROPERTY DAMAGE, PERSONAL INJURY OR DEATH.</p> 

A step-down transformer (208/240 volt primary to 24 volt secondary) is provided with each indoor unit. This allows ample capacity for use with resistance heaters. The outdoor sections do not contain a transformer (see note below).

NOTE: Communicating condensing units may have an optional 240VAC to 24VAC transformer installed. This transformer provides 24VAC power to the unitary (UC) control in some communicating system installation scenarios.

 WARNING
<p>DISCONNECT ALL POWER BEFORE SERVICING.</p>

1. Remove control panel cover, or etc., to gain access to transformer.

With power ON:

 WARNING
<p>LINE VOLTAGE NOW PRESENT.</p>

2. Using a voltmeter, check voltage across secondary voltage side of transformer (R to C).
3. No voltage indicates faulty transformer, bad wiring, or bad splices.
4. Check transformer primary voltage at incoming line voltage connections and/or splices.
5. If line voltage available at primary voltage side of transformer and wiring and splices good, transformer is inoperative. Replace.

CHECKING TIME DELAY RELAY

Time delays are used in electric heaters to sequence in multiple electric heaters.

 WARNING
<p>DISCONNECT ALL POWER BEFORE SERVICING.</p>

1. Tag and disconnect all wires from male spade connections of relay.

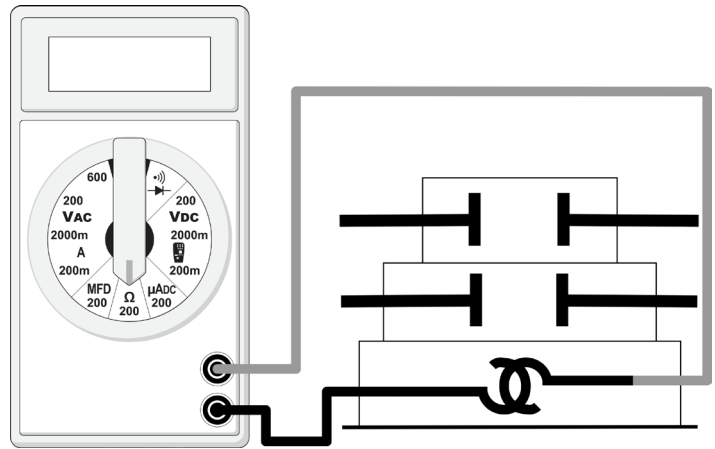

TESTING COIL CIRCUIT

CHECKING UNITARY (UC) CONTROL COMPRESSOR CONTACTOR/RELAY CONTACTS

 WARNING
<p>DISCONNECT ALL POWER BEFORE SERVICING.</p>

1. Connect voltmeter to lugs (L2) and (C).
2. With power ON, provide a call for cool or heat pump to energize the on-board compressor contactor/relay.



 WARNING
<p>LINE VOLTAGE NOW PRESENT.</p>

3. Measure voltage across on-board compressor contactor/relay contacts.
 - A. No voltage indicates the contacts are closed and the contactor/relay is functioning properly.
 - B. A reading of approximately half of the supply voltage (example: 115VAC for 230VAC) indicates the relay is open. Replace UC control if relay does not close.

NOTE: The unitary (UC) control has a built-in short cycle delay. Ensure short cycle delay has elapsed before making voltage measurements.

SERVICING

CHECKING HIGH AND LOW VOLTAGE TO ECM MOTOR

 WARNING
<p>HIGH VOLTAGE! DISCONNECT ALL POWER BEFORE SERVICING OR INSTALLING. MULTIPLE POWER SOURCES MAY BE PRESENT. FAILURE TO DO SO MAY CAUSE PROPERTY DAMAGE, PERSONAL INJURY OR DEATH.</p> 

1. Measure voltage between black and brown motor leads. This should measure 208/230 volts depending on your power supply.
2. If voltage is present proceed to check fan relay contacts and voltage.

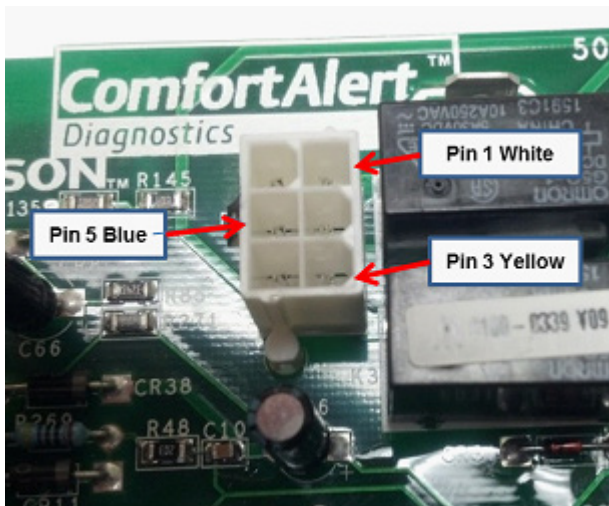

CHECKING FAN RELAY CONTACTS - ECM FAN MOTOR

1. Disconnect fan motor harness from plug on the UC board.
2. Energize the system in low stage and check voltage:
 - Pin 5(Blue wire) to Pin 3(Yellow wire) = 24VAC
3. Energize the system in high stage and check voltage:
 - Pin 5(Blue wire) to Pin 3(Yellow wire) = 24VAC
 - Pin 5(Blue wire) to Pin 1(White wire) = 24 VAC



4. If voltage is present at these pins plug harness into plug on PC board and check voltages at motor to test for broken wires.
5. If all voltages are present motor is defective and needs to be replaced.

CHECKING RELAY CONTACTS - PSC FAN MOTOR

 WARNING
<p>HIGH VOLTAGE! DISCONNECT ALL POWER BEFORE SERVICING OR INSTALLING. MULTIPLE POWER SOURCES MAY BE PRESENT. FAILURE TO DO SO MAY CAUSE PROPERTY DAMAGE, PERSONAL INJURY OR DEATH.</p> 

1. Disconnect the motor leads from 6-circuit fan motor wire harness.
2. Connect a voltmeter between circuit 3 and circuits 2 (low speed) or 1 (high speed).



NOTE: Circuit 3 is connected directly to L2.

3. Energize the system at low or high stage.

 WARNING
LINE VOLTAGE NOW PRESENT.

4. The measured voltage between circuit 3 and circuits 2 or 1 should be approximately 0VAC, which indicates the relay contacts are closed. A voltage measurement of approximately 115VAC indicates the relay is open. Replace the control if the relay checks open when it should be closed.



COPELAND COMFORT ALERT™ - UNITARY (UC) CONTROL DIAGNOSTICS APPLIES TO ASXC, ASZC, AND DSZC 2-STAGE MODELS

 WARNING
<p>HIGH VOLTAGE! DISCONNECT ALL POWER BEFORE SERVICING OR INSTALLING. MULTIPLE POWER SOURCES MAY BE PRESENT. FAILURE TO DO SO MAY CAUSE PROPERTY DAMAGE, PERSONAL INJURY OR DEATH.</p> 

The Copeland Comfort Alert™ diagnostics are fully integrated into the unitary (UC) control. The UC control and integrated Comfort Alert™ diagnostics provide around-the-clock monitoring for common electrical problems, compressor defects and broad system faults. If a problem is detected, LED indicators flash the proper alert codes to help you quickly pinpoint the problem.

SERVICING

CHECKING HIGH PRESSURE CONTROL

 WARNING	
HIGH VOLTAGE! DISCONNECT ALL POWER BEFORE SERVICING OR INSTALLING. MULTIPLE POWER SOURCES MAY BE PRESENT. FAILURE TO DO SO MAY CAUSE PROPERTY DAMAGE, PERSONAL INJURY OR DEATH.	

The high pressure control capillary senses the pressure in the compressor discharge line. If abnormally high condensing pressures develop, the contacts of the control open, breaking the control circuit before the compressor motor overloads. This control is automatically reset.

TEST 1. TESTING HIGH PRESSURE CONTROL IN COOLING MODE

1. Connect refrigerant gages to unit.
2. Disconnect power to outdoor unit.
3. Remove control panel cover.
4. Disconnect black wire from condenser fan motor (single stage units) or remove plug from control board on 2 stage units. Note: Tape or isolate black wire to prevent possible short.
5. Apply power to unit and set thermostat to cool and set for all for cool.
6. High pressure switch should open at 610 PSIG +/- 10 PSIG and close at 420 PSIG +/- 25 PSIG
7. If high pressure switch does not operate in these parameters replace switch.

TEST 2. TESTING HIGH PRESSURE CONTROL IN HEATING MODE

1. Connect refrigerant gages to unit.
2. Disconnect power to indoor unit.
3. Remove control panel cover.
4. Disconnect black wire from evaporator fan motor (single stage units) or remove plug from control board on 2 stage units. Note: Tape or isolate black wire to prevent possible short.
5. Apply power to unit and set thermostat to heat and set for call for heat.
6. High pressure switch should open at 610 PSIG +/- 10 PSIG and close at 420 PSIG +/- 25 PSIG
7. If high pressure switch does not operate in these parameters replace switch.

With power ON:

 WARNING
LINE VOLTAGE NOW PRESENT.

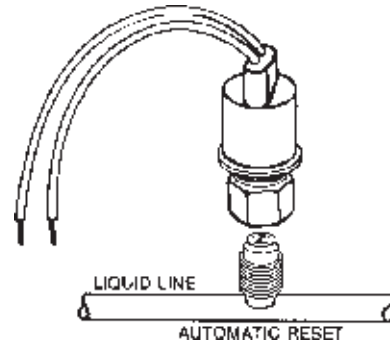

CHECKING LOW PRESSURE CONTROL

The low pressure control senses the pressure in the suction line and will open its contacts on a drop in pressure. The low pressure control will automatically reset itself with a rise in pressure.

TEST 1. TESTING LOW PRESSURE CONTROL IN COOLING MODE

1. Connect refrigerant gages to unit.
2. Disconnect power to indoor unit.
3. Remove control panel cover.
4. Disconnect black wire from evaporator fan motor (single stage units) or remove plug from control board on 2 stage units. Note: Tape or isolate black wire to prevent possible short.
5. Apply power to unit and set thermostat to cool and set for a call for cool.
6. Low pressure switch should open at 21 PSIG, and auto reset (close) at approximately 50 PSIG.
7. If low pressure switch does not operate in these parameters replace switch.

TEST 2. TESTING LOW PRESSURE CONTROL IN HEATING MODE

1. Connect refrigerant gages to unit.
2. Disconnect power to outdoor unit.
3. Remove control panel cover.
4. Disconnect black wire from condenser fan motor (single stage units) or remove plug from control board on 2 stage units. Note: Tape or isolate black wire to prevent possible short.
5. Apply power to unit and set thermostat to cool and set for all for cool.
6. Low pressure switch should open at 21 PSIG and auto reset (close) at approximately 50 PSIG
7. If low pressure switch does not operate in these parameters replace switch.

CHECKING HIGH AND LOW PRESSURE SWITCH VOLTAGE

The HPC and LPC are wired in series so output at both switches should be the same when switches are closed voltage reading should be 6.5vdc or 8.0vac. NOTE: the Discharge Thermostat is wired in series with the HPC if DT is open you will read input voltage on the HPC and no voltage on the output of HPC or LPC.

SERVICING



CHECKING CAPACITOR

CAPACITOR, RUN

A run capacitor is wired across the auxiliary and main windings of a single phase permanent split capacitor motor. The capacitor's primary function is to reduce the line current while greatly improving the torque characteristics of a motor. This is accomplished by using the 90° phase relationship between the capacitor current and voltage in conjunction with the motor windings, so that the motor will give two phase operation when connected to a single phase circuit. The capacitor also reduces the line current to the motor by improving the power factor.

The line side of this capacitor is marked with "COM" and is wired to the line side of the circuit.

RESISTANCE CHECK USING A DIGITAL MULTI-METER

 WARNING	
HIGH VOLTAGE! DISCONNECT ALL POWER BEFORE SERVICING OR INSTALLING. MULTIPLE POWER SOURCES MAY BE PRESENT. FAILURE TO DO SO MAY CAUSE PROPERTY DAMAGE, PERSONAL INJURY OR DEATH.	

CHECK FOR DIGITAL TEST

1. Set the meter on Ohm range (Set it at least 1000 Ohm=1k).

 WARNING
DISCHARGE CAPACITOR THROUGH A 200 TO 300 OHM RESISTOR BEFORE HANDLING.

2. Connect the Meter leads to the Capacitor terminals.
3. Digital meter will show a reading momentarily (Figure 1). Note the reading.



FIGURE 1



FIGURE 2

4. Reading will immediately return to the OL = (Open Line) (Figure 2). Every attempt of Step 2 will show the same result as was in step 4 and Step 5. This indicates that the capacitor is good.
5. If there is no Change, then capacitor is dead and must be replaced.

CHECK FOR ANALOG METER

- A. Good Condition - indicator swings to zero and slowly returns to infinity. (Start capacitor with bleed resistor will not return to infinity. It will still read the resistance of the resistor).
- B. Shorted - indicator swings to zero and stops there - replace.
- C. Open - no reading - replace. (Start capacitor would read resistor resistance.)

CAPACITANCE CHECK USING A DIGITAL MULTI-METER (IN CAPACITANCE MODE)

 WARNING
DISCHARGE CAPACITOR THROUGH A 200 TO 300 OHM RESISTOR BEFORE HANDLING.

NOTE: You can do this test with a multi-meter if you have a Capacitance meter on your multi-meter.

1. Remove the capacitor from the circuit.
2. Now Select "Capacitance" on your multi-meter.
3. Now connect the capacitor terminals to the multi-meter leads.
4. If the reading is near to the actual value of the capacitor (i.e. the printed value on the capacitor). The capacitor is good. (Note that the reading may be less than the actual printed value of the capacitor).
5. If you read a significantly lower capacitance or none at all, then capacitor is dead and must be replaced.

CAPACITOR, START SCROLL COMPRESSOR MODELS

In most cases hard start components are not required on Scroll compressor equipped units due to a non-replaceable check valve located in the discharge line of the compressor. However, in installations that encounter low lock rotor voltage, a hard start kit can improve starting characteristics and reduce light dimming within the home. Only hard start kits approved by Amana® brand or Copeland should be used. "Kick Start" and/or "Super Boost" kits are not approved start assist devices.

The discharge check valve closes off high side pressure to the compressor after shut down allowing equalization through the scroll flanks. Equalization requires only about ½ second.

SERVICING

To prevent the compressor from short cycling, a Time Delay Relay (Cycle Protector) has been added to the low voltage circuit.

TESTING A RUN CAPACITOR UNDER LOAD

1. Measure the amperage of the wire from Herm on the capacitor to start terminal on compressor.
2. Multiply the amperage reading by the constant of 2,652.
3. Measure voltage across the capacitor between "HERM" and "C" terminals this is the measured voltage across the start and run terminals on the compressor.
4. Divide total from step 2 by the voltage measurement. This total is the capacitance. This give a more accurate measurement of the capacitor's performance.
5. Read the rated MFD on the capacitor and compare to your actual readings. If outside of +/- tolerance stated on the capacitor, replacement of the capacitor may be recommended.

Formula: Start Winding Amps x 2,652 ÷ capacitor voltage = microfarads.

CHECKING EMERSON ULTRATECH™ ECM MOTORS

DESCRIPTION

The ComfortBridge Air Handlers models utilize an Emerson, 4-wire variable speed ECM blower motor. The ECM blower motor provides constant CFM.

The motor is a serially communicating variable speed motor. Only four wires are required to control the motor: +Vdc, Common, Receive, and Transmit.

The +Vdc and Common wires provide power to the motor's low voltage control circuits.

GENERAL CHECKS/CONSIDERATIONS



1. Check power supply to the air handler or modular blower. Ensure power supply is within the range specified on rating plate.
2. Check motor power harness. Ensure wires are continuous and make good contact when seated in the connectors. Repair or replace as needed.
3. Check motor control harness. Ensure wires are continuous and make good contact when seated in the connectors. Repair or replace as needed.
4. Check thermostat and thermostat wiring. Ensure thermostat is providing proper cooling/heating/continuous fan demands. Repair or replace as needed.
5. Check blower wheel. Confirm wheel is properly seated on motor shaft. Set screw must be on shaft flat and torqued to 165 in-lbs minimum. Confirm

wheel has no broken or loose blades. Repair or replace as needed.

6. Ensure motor and wheel turn freely. Check for interference between wheel and housing or wheel and motor. Repair or replace as needed.
7. Check housing for cracks and/or corrosion. Repair or replace as needed.
8. Check motor mounting bracket. Ensure mounting bracket is tightly secured to the housing. Ensure bracket is not cracked or broken.

EMERSON ULTRACHECK-EZ™ DIAGNOSTIC TOOL

The Emerson UltraCheck-EZ™ diagnostic tool may be used to diagnose the ECM motor.

 WARNING	
HIGH VOLTAGE! DISCONNECT ALL POWER BEFORE SERVICING OR INSTALLING. MULTIPLE POWER SOURCES MAY BE PRESENT. FAILURE TO DO SO MAY CAUSE PROPERTY DAMAGE, PERSONAL INJURY OR DEATH.	

To use the diagnostic tool, perform the following steps:

1. Disconnect power to the air handler.
2. Disconnect the 4-circuit control harness from the motor.
3. Plug the 4-circuit connector from the diagnostic tool into the motor control connector.
4. Connect one alligator clip from the diagnostic tool to a ground source.
5. Connect the other alligator clip to a 24VAC source.

NOTE: The alligator clips are NOT polarized.

NOTE: The UltraCheck-EZ™ diagnostic tool is equipped with a non-replaceable fuse. Connecting the tool to a source other than 24VAC could damage the tool and cause the fuse to open. Doing so will render the diagnostic tool inoperable.

6. Turn on power to air handler or modular blower.

 WARNING
LINE VOLTAGE NOW PRESENT.

7. Depress the orange power button on the diagnostic tool to send a run signal to the motor. Allow up to 5 seconds for the motor to start.

NOTE: If the orange power button does not illuminate when depressed, the tool either has an open fuse or is not properly connected to a 24VAC source.

SERVICING

- The green LED on the diagnostic tool will blink indicating communications between the tool and motor. See table below for indications of tool indicators and motor actions. Replace or repair as needed.

Power Button	Green LED	Motor Action	Indication(s)
OFF	OFF	Not Rotating	Confirm 24VAC to UltraCheck-EZ™ tool. If 24VAC is confirmed, diagnostic tool is inoperable.
ON	Blinking	Rotating	Motor and control/end bell are functioning properly.
ON	OFF	Rotating	Replace motor control/end bell.
ON	Blinking	Not Rotating	Check motor (see <i>Motor Checks</i> below).
ON	OFF	Not Rotating	Replace motor control/end bell; verify motor (see <i>Motor Checks</i> below).

- Depress the orange power button to turn off motor.
- Disconnect power. Disconnect diagnostic tool.
- Reconnect the 4-wire harness from control board to motor.

ELECTRICAL CHECKS - HIGH VOLTAGE POWER CIRCUITS

 **WARNING**

HIGH VOLTAGE!
DISCONNECT ALL POWER BEFORE SERVICING OR INSTALLING. MULTIPLE POWER SOURCES MAY BE PRESENT. FAILURE TO DO SO MAY CAUSE PROPERTY DAMAGE, PERSONAL INJURY OR DEATH.



- Disconnect power to air handler or modular blower.
- Disconnect the 5-circuit power connector to the ECM motor.
- Turn on power to air handler or modular.

 **WARNING**

LINE VOLTAGE NOW PRESENT.

- Measure voltage between pins 4 and 5 on the 5-circuit connector. Measured voltage should be the same as the supply voltage to the air handler or modular.

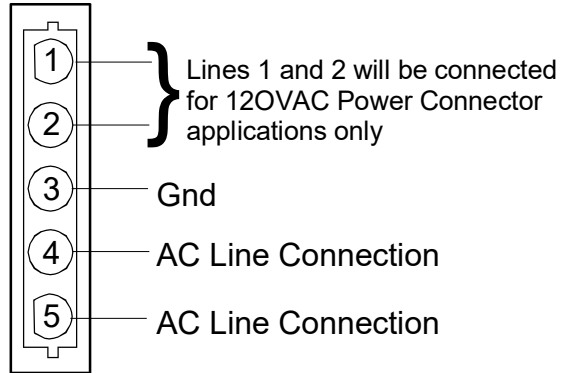

- Measure voltage between pins 4 and 3. Voltage should be approximately half of the voltage measured in step 4.
- Measure voltage between pins 5 and 3. Voltage should be approximately half of the voltage measured in step 4.
- If no voltage is present, check supply voltage to air handler or modular blower.
- Disconnect power to air handler or modular blower. Reconnect the 5-circuit power harness disconnected in step 2.

ELECTRICAL CHECKS - LOW VOLTAGE CONTROL CIRCUITS

- Turn on power to air handler or modular.

 **WARNING**

LINE VOLTAGE NOW PRESENT.

- Check voltage between pins on the 4-wire motor control harness between the motor and control board.
- Voltage on pins should read:
 - Pins 1 to 4 = 3.3vdc
 - Pins 1 to 2 = 3.3vdc
 - Pins 3 to 4 = 15vdc

MOTOR CONTROL/END BELL CHECKS

 **WARNING**

HIGH VOLTAGE!
DISCONNECT ALL POWER BEFORE SERVICING OR INSTALLING. MULTIPLE POWER SOURCES MAY BE PRESENT. FAILURE TO DO SO MAY CAUSE PROPERTY DAMAGE, PERSONAL INJURY OR DEATH.



- Disconnect power to air handler or modular blower.

NOTE: Motor contains capacitors that can hold a charge for several minutes after disconnecting power. Wait 5 minutes after removing power to allow capacitors to discharge.

SERVICING

2. Disconnect the motor control harness and motor power harness.
3. Remove the blower assembly from the air handler or modular blower.
4. Remove the (3) screws securing the control/end bell to the motor. Separate the control/end bell. Disconnect the 3-circuit harness from the control/end bell to remove the control/end bell from the motor.
5. Inspect the NTC thermistor inside the control/end bell (see figure below). Replace control/end bell if thermistor is cracked or broken.

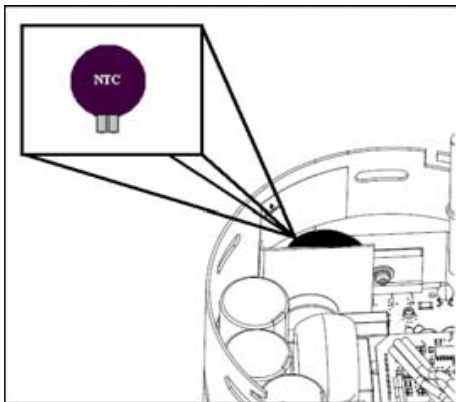

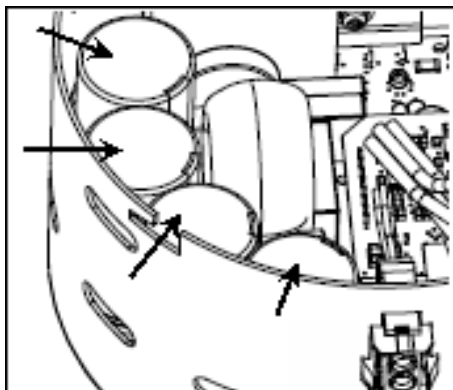

6. Inspect the large capacitors inside the control/end bell (see figure below). Replace the control/end bell if any of the capacitors are bulging or swollen.



7. Locate the 3-circuit connector in the control/end bell. Using an ohmmeter, check the resistance between each terminal in the connector. If the resistance is 100 W or greater, the control/end bell is functioning properly. Replace the control/end bell if the resistance is lower than 100 W.
8. Reassemble motor and control/end bell in reverse of disassembly. Replace blower assembly into air handler or modular blower.

MOTOR CHECKS

 WARNING	
HIGH VOLTAGE! DISCONNECT ALL POWER BEFORE SERVICING OR INSTALLING. MULTIPLE POWER SOURCES MAY BE PRESENT. FAILURE TO DO SO MAY CAUSE PROPERTY DAMAGE, PERSONAL INJURY OR DEATH.	

1. Disconnect power to air handler or modular blower.

NOTE: Motor contains capacitors that can hold a charge for several minutes after disconnecting power. Wait 5 minutes after removing power to allow capacitors to discharge.

2. Disassemble motor as described in steps 2 through 4 above.
3. Locate the 3-circuit harness from the motor. Using an ohmmeter, measure the resistance between each motor phase winding. The resistance levels should be equal. Replace the motor if the resistance levels are unequal, open circuited or short circuited.
4. Measure the resistance between each motor phase winding and the motor shell. Replace the motor if any phase winding is short circuited to the motor shell.
5. Reassemble motor and control/end bell in reverse of disassembly. Replace blower assembly into air handler or modular blower.

CHECKING COMPRESSOR

 WARNING
HERMETIC COMPRESSOR ELECTRICAL TERMINAL VENTING CAN BE DANGEROUS. WHEN INSULATING MATERIAL WHICH SUPPORTS A HERMETIC COMPRESSOR OR ELECTRICAL TERMINAL SUDDENLY DISINTEGRATES DUE TO PHYSICAL ABUSE OR AS A RESULT OF AN ELECTRICAL SHORT BETWEEN THE TERMINAL AND THE COMPRESSOR HOUSING, THE TERMINAL MAY BE EXPELLED, VENTING THE VAPOR AND LIQUID CONTENTS OF THE COMPRESSOR HOUSING AND SYSTEM.

If the compressor terminal PROTECTIVE COVER and gasket (if required) are not properly in place and secured, there is a remote possibility if a terminal vents, that the vaporous and liquid discharge can be ignited, spouting flames several feet, causing potentially severe or fatal injury to anyone in its path.

This discharge can be ignited external to the compressor if the terminal cover is not properly in place and if the discharge impinges on a sufficient heat source. Ignition of the discharge can also occur at the venting terminal or inside the compressor, if there is sufficient contaminant air present in the system and an electrical arc occurs as the terminal vents.

SERVICING

Ignition cannot occur at the venting terminal without the presence of contaminant air, and cannot occur externally from the venting terminal without the presence of an external ignition source.

Therefore, proper evacuation of a hermetic system is essential at the time of manufacture and during servicing.

To reduce the possibility of external ignition, all open flame, electrical power, and other heat sources should be extinguished or turned off prior to servicing a system.

If the following test indicates shorted, grounded or open windings, see procedures for the next steps to be taken.



RESISTANCE TEST

Each compressor is equipped with an internal overload.

The line break internal overload senses both motor amperage and winding temperature. High motor temperature or amperage heats the disc causing it to open, breaking the common circuit within the compressor on single phase units.

Heat generated within the compressor shell, usually due to recycling of the motor, high amperage or insufficient gas to cool the motor, is slow to dissipate. Allow at least three to four hours for it to cool and reset, then retest.

Fuse, circuit breaker, ground fault protective device, etc. has not tripped.

 WARNING	
HIGH VOLTAGE! DISCONNECT ALL POWER BEFORE SERVICING OR INSTALLING. MULTIPLE POWER SOURCES MAY BE PRESENT. FAILURE TO DO SO MAY CAUSE PROPERTY DAMAGE, PERSONAL INJURY OR DEATH.	

1. Remove the leads from the compressor terminals.

 WARNING
SEE WARNINGS BEFORE REMOVING COMPRESSOR TERMINAL COVER.

2. Using an ohmmeter, test continuity between terminals S-R, C-R, and C-S, on single phase units.

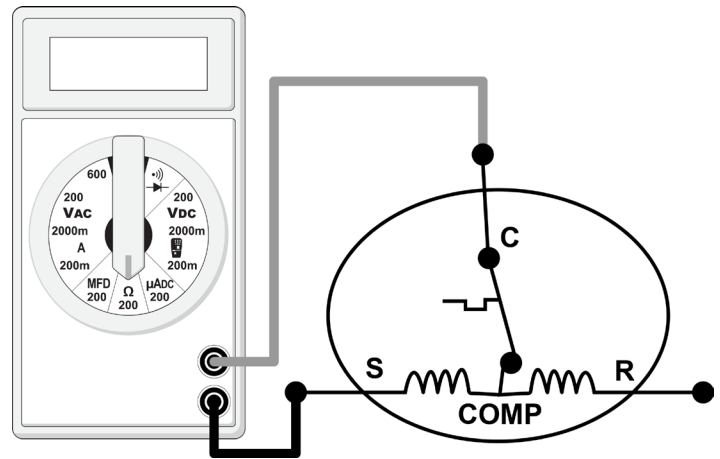

TESTING COMPRESSOR WINDINGS

If either winding does not test continuous, replace the compressor.

NOTE: If an open compressor is indicated, allow ample time for the internal overload to reset before replacing compressor.

GROUND TEST

If fuse, circuit breaker, ground fault protective device, etc. has tripped, this is a strong indication that an electrical problem exists and must be found and corrected. The circuit protective device rating must be checked and its maximum rating should coincide with that marked on the equipment nameplate.

With the terminal protective cover in place, it is acceptable to replace the fuse or reset the circuit breaker **ONE TIME ONLY** to see if it was just a nuisance opening. If it opens again, **DO NOT** continue to reset.

Disconnect all power to unit, making sure that all power legs are open.

1. Carefully remove the compressor terminal protective cover and inspect for loose leads or insulation breaks in the lead wires.
2. Disconnect the three leads going to the compressor terminals at the compressor or nearest point to the compressor.
3. Check for a ground separately between each of the three terminals and ground (such as an unpainted tube on the compressor). If there is any reading of continuity to ground on the meter, the compressor should be considered defective.
4. If ground is indicated, replace the compressor.

SERVICING

⚠ WARNING

DAMAGE CAN OCCUR TO THE GLASS EMBEDDED TERMINALS IF THE LEADS ARE NOT PROPERLY REMOVED. THIS CAN RESULT IN TERMINAL AND HOT OIL DISCHARGING.

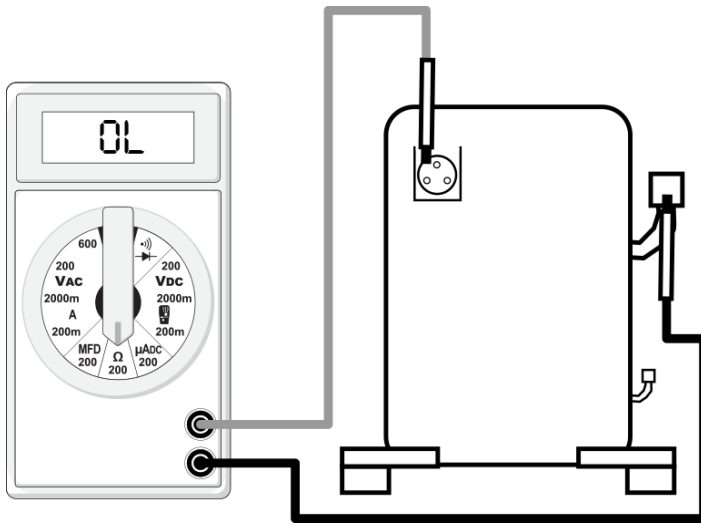

COMPRESSOR GROUND TEST

2. If Step 1 does not give the expected results remove the solenoid plug from the compressor and with the unit running and the thermostat calling for Y2 to be energized test the voltage output at the plug with a dc voltmeter. The reading should be 4 to 18 VDC for Comfort Alert. If not, unplug the harness from the module and check voltage at the “High” pins of the module. The module will not power the unloader solenoid if the compressor is not running.
3. If the correct DC voltage is at the control circuit molded plug measure the unloader coil resistance. Shut off power and remove the control circuit molded plug from the compressor and measure the unloader solenoid coil resistance. If the coil resistance is infinite, zero, or grounded, the compressor must be replaced.

LOCKED ROTOR TEST

If fuse, circuit breaker, ground fault protective device, etc. has tripped, this is a strong indication that an electrical problem exists and must be found and corrected. The circuit protective device rating must be checked and its maximum rating should coincide with that marked on the equipment nameplate.

UNLOADER TEST PROCEDURE WITH COMFORT ALERT™ UNITARY (UC) CONTROL DIAGNOSTICS

If you suspected that the unloader is not working, the following methods may be used to verify operation.



1. Operate the system and measure compressor amperage. Cycle the unloader on and off at ten second intervals by applying and removing Y2 voltage to the module. Wait five seconds after power is applied to Y2 before taking a reading. An increase in compressor amperage should be observed when switching from part-load to full-load and a reduction in compressor amperage should be observed when changing from full-load to part-load. The percent change in current depends on the operating conditions and voltage.

Before checking for locked rotor, the compressor terminals should be checked for open windings (see S-17A Resistance Test) and the run capacitor and start capacitor (if used) should be checked thoroughly (see S-15 Checking Capacitor).

With power ON:

⚠ WARNING



LINE VOLTAGE NOW PRESENT.

1. Check the serial data plate for the compressor locked rotor amps (LRA) rating.
2. Using an ampmeter, measure the amperage reading for the run and common wires to the compressor. Since the compressor motor overload will likely trip soon after drawing locked rotor amps, this measurement should be taken as soon as the compressor starts.
3. If the amperage reading roughly equals the compressor LRA rating and all other checks have been completed, locked rotor amps has been verified.

OPERATION TEST

If the voltage, capacitor, overload and motor winding test fail to show the cause for failure:

SERVICING

 WARNING
<p>HIGH VOLTAGE! DISCONNECT ALL POWER BEFORE SERVICING OR INSTALLING. MULTIPLE POWER SOURCES MAY BE PRESENT. FAILURE TO DO SO MAY CAUSE PROPERTY DAMAGE, PERSONAL INJURY OR DEATH.</p> 

1. Remove unit wiring from disconnect switch and wire a test cord to the disconnect switch.

NOTE: The wire size of the test cord must equal the line wire size and the fuse must be of the proper size and type.

2. With the protective terminal cover in place, use the three leads to the compressor terminals that were disconnected at the nearest point to the compressor and connect the common, start and run clips to the respective leads.
3. Connect good capacitors of the right MFD and voltage rating into the circuit as shown.
4. With power ON, close the switch.

 WARNING
LINE VOLTAGE NOW PRESENT.

- A. If the compressor starts and continues to run, the cause for failure is somewhere else in the system.
- B. If the compressor fails to start - replace.

COPELAND COMPRESSOR

03	A	12345	L
YEAR	MONTH	SERIAL NUMBER	PLANT

TESTING CRANKCASE HEATER (OPTIONAL ITEM)

The crankcase heater must be energized a minimum of four (4) hours before the condensing unit is operated.

Crankcase heaters are used to prevent migration or accumulation of refrigerant in the compressor crankcase during the off cycles and prevents liquid slugging or oil pumping on start up.

A crankcase heater will not prevent compressor damage due to a floodback or over charge condition.

 WARNING
DISCONNECT ALL POWER BEFORE SERVICING.

1. Disconnect the heater lead in wires.
2. Using an ohmmeter, check heater continuity - should test continuous. If not, replace.

NOTE: The positive temperature coefficient crankcase heater is a 40 watt 265 voltage heater. The cool resistance of the heater will be approximately 1800 ohms. The resistance will become greater as the temperature of the compressor shell increases.

CHECKING REVERSING VALVE AND SOLENOID

Occasionally the reversing valve may stick in the heating or cooling position or in the mid-position.

When stuck in the mid-position, part of the discharge gas from the compressor is directed back to the suction side, resulting in excessively high suction pressure. An increase in the suction line temperature through the reversing valve can also be measured. Check operation of the valve by starting the system and switching the operation from COOLING to HEATING cycle.

If the valve fails to change its position, test the voltage (24V) at the valve coil terminals, while the system is on the COOLING cycle.

All heat pumps and communicating heat pumps wired in legacy - If no voltage is registered at the coil terminals, check the operation of the thermostat and the continuity of the connecting wiring from the "O" terminal of the thermostat to the unit.

Communicating heat pumps only - Check voltage (24VAC) at the non-insulated terminal E22 on the UC control board (RVS on silkscreen) and "C" terminal on the 7-pin or 4-pin connector on the UC control

If voltage is registered at the coil, tap the valve body lightly while switching the system from HEATING to COOLING, etc. If this fails to cause the valve to switch positions, remove the coil connector cap and test the continuity of the reversing valve solenoid coil. If the coil does not test continuous - replace it.

If the coil test continuous and 24 volts is present at the coil terminals, the valve is inoperative - replace it.

SERVICING

TESTING DEFROST CONTROL

LEGACY MODELS:

COMMUNICATING UNITS:

To check the defrost control for proper sequencing, proceed as follows: With power ON; unit not running.

1. Set thermostat to call for heating.
2. Press **TEST** and **RECALL** buttons simultaneously for approximately 3 seconds, then release them. System should go into defrost immediately.
3. Using VOM check for voltage across terminals "C & O". Meter should read 24 volts (skip this step if system a fully communicating system)
4. Visually inspect to see that the frost is gradually melting on the coil and the compressor is running.
5. Using VOM check for voltage across "W2 & C" terminals on the board. You should read 24 volts.
6. If not as above, replace control board.
7. Set thermostat to off position and disconnect power before removing any jumpers or wires.



TESTING TEMPERATURE SENSORS

(COMMUNICATING READY MODELS ONLY)

The ASXC and DSXC **communicating** air conditioner models are factory equipped with an outdoor air temperature (OAT) sensor.

The ASZC and DSZC **communicating** heat pump models are equipped with both an outdoor air temperature (OAT) sensor and an outdoor coil temperature (OCT) sensor. The OAT provides the balance point temperature in heat pump systems (air handler w/electric heat + heat pump) and dual fuel systems. The OCT sensor provides the outdoor coil temperature and is used in determining defrost cycles.

To check either the outdoor air or outdoor coil temperature sensors:

 WARNING
<p>HIGH VOLTAGE! DISCONNECT ALL POWER BEFORE SERVICING OR INSTALLING. MULTIPLE POWER SOURCES MAY BE PRESENT. FAILURE TO DO SO MAY CAUSE PROPERTY DAMAGE, PERSONAL INJURY OR DEATH.</p> 

1. Disconnect power to the air conditioner or heat pump.
2. Disconnect the sensor from the unitary (UC) control.
3. Connect an ohmmeter across the sensor terminals. The ohmmeter should read be 10kW, +/-10%, at 75°F. Replace the sensor if the sensor is open, shorted, or outside the valid resistance range.

AVPTC/MBVC HEATER CONTROL

DESCRIPTION

The ComfortBridge models utilize an electronic control that provides ECM blower motor control and control of up to two electric heat sequencers. The control has thermostat inputs for 2 stages of cooling, and one stage of electric heat (electric heat staging is done internally), and dehumidification. Control input is 24VAC. Dehumidification is enabled/disabled via thermostat.

FEATURES

The new handler control includes advanced diagnostic features with fault recall and estimated CFM display via on-board LED. Diagnostics include heater kit selection diagnostics, open fuse, internal control fault, data errors, and blower motor faults.

The estimated CFM is displayed on the LED digital display. ex. A08 = 800 CFM.

Ohm Reading of Communicating Outdoor Unit Sensors									
T, °F	RW@T	T, °F	RW@T	T, °F	RW@T	T, °F	RW@T	T, °F	RW@T
-40	336,000	5	72,940	50	19,903	95	6,530	140	2,488
-31	242,700	14	55,319	59	15,714	104	5,327	149	2,083
-22	177,000	23	42,324	68	12,493	113	4,370	158	1,752
-13	130,400	32	32,654	77	10,000	122	3,603	167	1,480
-4	97,060	41	25,396	86	8,056	134	2,986	176	1,255

SERVICING



The ComfortBridge air handlers may be used in a full communicating system when matched with a compatible outdoor system. A fully communicating system offers advanced setup and diagnostic features.

BASIC OPERATION

The air handler control receives thermostat inputs from a 24VAC thermostat. For cooling and heat pump operation, the control operates the variable speed blower motor at the demand as determined from the thermostat input(s). If a demand for electric heat is received, the control will provide a 24VAC output for up to two electric heat sequencers.

TROUBLESHOOTING

MOTOR CONTROL CIRCUITS



 WARNING
<p>HIGH VOLTAGE! DISCONNECT ALL POWER BEFORE SERVICING OR INSTALLING. MULTIPLE POWER SOURCES MAY BE PRESENT. FAILURE TO DO SO MAY CAUSE PROPERTY DAMAGE, PERSONAL INJURY OR DEATH.</p> 

1. Turn on power to air handler or modular.

 WARNING
LINE VOLTAGE NOW PRESENT.

2. Check voltage between pins 1 and 4 at the 4-wire motor connector on the control board. See *Electrical Checks - Low Voltage Control Circuits* section.

ELECTRIC HEAT SEQUENCER OUTPUTS

 WARNING
<p>HIGH VOLTAGE! DISCONNECT ALL POWER BEFORE SERVICING OR INSTALLING. MULTIPLE POWER SOURCES MAY BE PRESENT. FAILURE TO DO SO MAY CAUSE PROPERTY DAMAGE, PERSONAL INJURY OR DEATH.</p> 

1. Turn on power to air handler or modular blower.

 WARNING
LINE VOLTAGE NOW PRESENT.

2. Disconnect the 4-circuit harness connecting the control to the electric heater kit.
3. Provide a thermostat demand for low stage auxiliary heat (W1). Measure the voltage between circuits

1 and 3 at the on-board electric heat connector. Voltage should measure 24VAC. Replace control if no voltage is present.

NOTE: Allow for any built-in time delays before making voltage measurements. Any electric heater faults that are present may prevent the heater output from energizing. Verify that no heater faults are present before making voltage measurements.

4. Provide a thermostat demand for high stage auxiliary heat (W1 + W2). Measure the voltage between circuits 1 and 3 at the on-board electric heat connector. Measure the voltage between circuits 2 and 3 at the on-board electric heat connector. Voltage should measure 24VAC. Replace control if no voltage is present.

The integrated air handler control has some on-board tools that may be used to troubleshoot the network. These tools are: red communications LED, green receive (Rx) LED, and learn button. These are described below:

- A. Red communications LED – Indicates the status of the network. Refer to the Network Troubleshooting Chart for the LED status and the corresponding potential problem.
- B. Green receive LED – Indicates network traffic. Refer to the Network Troubleshooting Chart for the LED status and the corresponding potential problem.
- C. Learn button – Used to reset the network. Depress the button for approximately 2 seconds to reset the network.

Voltages between the two data lines and between each data line and common may be used to determine if the network is operating properly.

Do the following to measure the voltages on the communications data lines.

 WARNING
LINE VOLTAGE NOW PRESENT.

DATA LINE VOLTAGE TROUBLESHOOTING AND BIAS SWITCHES

Proper data voltage is essential to robust and reliable communication on the **communicating** system. Any wiring issues must be corrected for good communication.

- Poor wiring connections at the terminal blocks
- Low voltage wires that are shorted, grounded or broken.
- Communicating wires that are not connected to the proper terminals at the connector.

SERVICING

- 24 volt common outside and inside are not at the same ground potential.
- It is **STRONGLY** recommended that you do not connect multiple wires into a single terminal on the wiring connector.
- Wire nuts are recommended to connect multiple wires to connector ensuring one wire is used for each terminal.
- Failure to do so may result in intermittent operation.
- Typical 18 AWG thermostat wire may be used to wire the system components. One hundred feet is the maximum length of wire between indoor and outdoor units or between indoor unit and thermostat.
- When outdoor transformer is used and there at least three thermostat wires running to the outdoor unit use one of the extra wires to connect the two 24 volt commons together. This will ensure both 24 volt commons are at the same ground potential.
- When outdoor transformer is used and there are only two thermostat wires running to the outdoor unit ground the 24 volt common "C" of the outdoor transformer to a chassis ground (earth ground. This is not as good as the third wire but it is better than leaving the outdoor 24 volt common floating.

ELECTRIC HEATER (OPTIONAL ITEM)

Optional electric heaters may be added, in the quantities shown in the specifications section, to provide electric resistance heating. Under no condition shall more heaters than the quantity shown be installed.

The low voltage circuit in the air handler is factory wired and terminates at the location provided for the electric heater(s). A minimum of field wiring is required to complete the installation.

Other components such as a Heating/Cooling Thermostat and Outdoor Thermostats are available to complete the installation.

The system CFM can be determined by measuring the static pressure external to the unit. The installation manual supplied with the blower coil, or the blower performance table in the service manual, shows the CFM for the static measured.

Alternately, the system CFM can be determined by operating the electric heaters and indoor blower **WITHOUT** having the compressor in operation. Measure the temperature rise as close to the blower inlet and outlet as possible.

If other than a 240V power supply is used, refer to the **BTUH CAPACITY CORRECTION FACTOR** chart below.

BTUH CAPACITY CORRECTION FACTOR				
SUPPLY VOLTAGE	250	230	220	208
MULTIPLICATION FACTOR	1.08	.92	.84	.75

EXAMPLE: Five (5) heaters provide 24.0 KW at the rated 240V. Our actual measured voltage is 220V, and our measured temperature rise is 42°F. Find the actual CFM:

Answer: 24.0KW, 42°F Rise, 240 V = 1800 CFM from the **TEMPERATURE RISE** chart on the right.

Heating output at 220 V = 24.0KW x 3.413 x .84 = 68.8 MBH.

Actual CFM = 1800 x .84 Corr. Factor = 1400 CFM.

NOTE: The temperature rise table is for sea level installations. The temperature rise at a particular KW and CFM will be greater at high altitudes, while the external static pressure at a particular CFM will be less.

TEMPERATURE RISE (°F) @ 240V								
CFM	3.0 kW	4.8 kW	7.2 kW	9.6 kW	14.4 kW	19.2 kW	24.0 kW	28.8 kW
600	16	25	38	51	-	-	-	-
700	14	22	33	43	-	-	-	-
800	12	19	29	38	57	-	-	-
900	11	17	26	34	51	-	-	-
1000	10	15	23	30	46	-	-	-
1100	9	14	21	27	41	55	-	-
1200	8	13	19	25	38	50	-	-
1300	7	12	18	23	35	46	-	-
1400	7	11	16	22	32	43	54	65
1500	6	10	15	20	30	40	50	60
1600	6	9	14	19	28	38	47	57
1700	6	9	14	18	27	36	44	53
1800	5	8	13	17	25	34	42	50
1900	5	8	12	16	24	32	40	48
2000	5	8	12	15	23	30	38	45
2100	5	7	11	14	22	29	36	43
2200	4	7	11	14	21	27	34	41
2300	4	7	10	13	20	26	33	39

ELECTRIC HEATER CAPACITY BTUH								
HTR KW	3.0 KW	4.7 KW	6.0 KW	7.0 KW	9.5 KW	14.2 KW	19.5 KW	21.0 KW
BTUH	10200	16200	20400	23800	32400	48600	66500	71600

SERVICING

FORMULAS:

$$\begin{aligned}\text{Heating Output} &= \text{KW} \times 3413 \times \text{Corr. Factor} \\ \text{Actual CFM} &= \text{CFM (from table)} \times \text{Corr. Factor} \\ \text{BTUH} &= \text{KW} \times 3413 \\ \text{BTUH} &= \text{CFM} \times 1.08 \times \text{Temperature Rise (T)} \\ \text{CFM} &= \frac{\text{KW} \times 3413}{1.08 \times T} \\ T &= \frac{\text{BTUH}}{\text{CFM} \times 1.08}\end{aligned}$$

CONTROL SYSTEM – GENERAL INFORMATION

The air handler contains internal logic to control equipment staging. An adjustable target runtime is available (range from 1 to 240 minutes) and set through the appropriate system menu. The system will constantly be adjusting staging in an effort to satisfy the thermostat call for cooling (Y only) or heating (W Only) as close to the set target runtime as possible. See information below for setting options.

Comfort Setting Menu (CFS): There are 6 options available in the Comfort Setting Menu which impacts system target run time and electric heat functionality. Electric heat operation adjustments only apply if a communicating heat pump is installed. Comfort Setting Options 1 – 5 have set values for the System Target Runtime and option 6 enables additional menus to customize all comfort settings. See list below for the System Target Run times associated with the first 5 Comfort Settings. These first 5 options are setup to help satisfy the thermostat slower or faster based on the selection where option 1, with a 10 minute Target Runtime, is attempting to satisfy much faster than option 5, with a 30 minute Target Runtime.

SYSTEM TARGET RUNTIME:

Comfort Setting Option 1) 10 Minute System Target Runtime
Comfort Setting Option 2) 15 Minute System Target Runtime
Comfort Setting Option 3) 20 Minute System Target Runtime
Comfort Setting Option 4) 25 Minute System Target Runtime
Comfort Setting Option 5) 30 Minute System Target Runtime

Electric Heat Adjustment: This system will automatically determine if the heat pump is capable of satisfying the thermostat in the selected System Target Runtime. If the heat pump is unable to satisfy in the selected time, electric heat settings will determine how many attempts should be given to the heat pump before temporarily locking it out and using the furnace. These electric heat settings also determine at what time the system should remove the temporary heat pump lockout and run the heat pump again. There are four adjustable items associated with back up

electric heat operation control. In the same way as the System Target Time, each of these items have defaulted values for Comfort Settings 1 – 5. Only when Comfort Setting 6 is selected will each item be available for full adjustment.

- 1. Stage Up Percent (7 segment menu SUP):** This is a value that determines how far past the target runtime the system should continue running the heat pump before transitioning to the furnace. For example, assume this menu was set to 20% with a target runtime of 20 minutes. If the thermostat did not remove the heating call after 20 minutes, the system would allow for an additional 20% heat pump run (20% of the 20 minute target is an additional 4 minutes). In this case, the system would turn on back up electric heat after 24 minutes if the thermostat call was still present. Each time this occurs, the system records this as a strike against the heat pump (the strike is important when looking at the Over Target Threshold)
- 2. Over Target Threshold (7 segment menu Ott):** If the heat pump has consecutively activated back up electric heat for the selected Over Target Threshold amount of times, meaning for this many consecutive cycles it has been unable to satisfy the target time by itself, then the heat pump will be temporarily locked out and the furnace will become the primary heat source.
- 3. Stage Down Percent (7 segment menu SdP):** This only applies when the heat pump and back up electric heat are activated on initial start-up. In this case, the system will try to determine when the best time to operate the heat pump individually again. To determine this, the system looks at how easily the air handler is able to satisfy the thermostat using the heat pump with back up electric heat. Assume this setting is 15% and the target time is 20 minutes. If the heat pump with back up electric heat can satisfy the thermostat in less than 17 minutes (20 minutes - 15% = 17 minutes) then the algorithm records a strike against the air handler (this strike is important when looking at the Under Target Threshold).
- 4. Under Target Threshold (7 segment menu Utt):** If the air handler is able to satisfy the thermostat using the heat pump with back up electric heat for the selected number of consecutive cycles the electric heat operation will be temporarily removed. The heat pump will then be used during the next cycle. If the heat pump can satisfy the thermostat in less than the System Target Runtime the back up heat operation will be completely removed and the heat pump will become the primary heat source again. If it fails to do so, the strike count against the furnace will be reset and the furnace will remain the temporary primary heat source until the Under Target Threshold is reached again.

SERVICING

The system will automatically make adjustments in an attempt to satisfy the thermostat as close to this target runtime as possible. After a power cycle or mode change (cooling to heating or heating to cooling) the system will run full capacity for the selected mode during the first thermostat call. Based on the selected target runtime and how long the initial cycle takes to satisfy the thermostat, the control algorithm will adjust the system stage times for a 2 stage unit or the capacity demand percentage for an inverter / modulating unit for the next cycle. NOTE: Actual run times may change depending on variations of load throughout the day.

The following table shows the default values for all Comfort Setting Options (1 – 5)

Comfort Setting Option	Target Time (Minutes)	Stage Up Percentage (%)	Stage Down Percentage (%)	Over Target Threshold (Strike Count)	Under Target Threshold (Strike Count)
1	10	20	20	2	10
2	15	20	20	4	8
3	20	20	20	6	6
4	25	20	20	8	4
5	30	20	20	10	2

The following table shows the ranges for each of item when the adjustable Comfort Setting Option 6 is selected. The table shows the minimum value, the maximum value and the defaulted value. All items can be adjusted up or down by increments of 1 which provides full flexibility for all items.

NOTE: It is critical that these numbers be set properly. If Comfort Setting option 3 is desired but a target time of 60 is preferred, select Comfort Setting Option 6 to enable all the adjustable menus, set the Target Time to 60 and make sure the other menus are set to match that of Comfort Setting Option 3.

Menu	Minimum Value	Maximum Value	Default Value
Target Time (t9t)	1 minute	240 minutes	60 minutes
Stage Up Percent (SUP)	0%	100%	20%
Stage Down Percent (SdP)	0%	100%	20%
Over Target Threshold (Ott)	1 strike	254 strikes	20 strikes
Under Target Threshold (Utt)	1 strike	254 strikes	20 strikes

CIRCULATOR BLOWER SPEED

The Airflow quantity is displayed as a number on the three 7 segment displays, rounded to the nearest 100 CFM. The display alternates airflow amount and the system operating status.

Each furnace has a “Maximum CFM” it is capable of providing. All fan operations (Constant CFM, Cooling Airflow Profiles, Low and High Stage gas heat airflow, outdoor Air Conditioner / Heat Pump Airflow, etc.) are based off of multipliers which are percentages of this maximum CFM.

Max CFM is as follows:

- 3 Ton Models 1400 CFM
- 4 Ton Models 1760 CFM
- 5 Ton Models 2200 CFM

For Communicating Outdoor Units: Main airflow adjustment is not required. The Outdoor unit will determine the appropriate amount of indoor airflow to request. Airflow Trims can be made if desired.

For Non-Communicating outdoor units, determine the proper airflow (based off tonnage of) the outdoor unit. Most cooling systems are designed to work with airflow between 350 and 450 CFM per ton. 400 CFM/TON is the industry standard. Once desired airflow has been determined, see Tonnage / Airflow table to identify the Tonnage Selection that is closest to the desired airflow. This table is based on 400 CFM per ton where Airflow = (400 CFM) x (Selected Tonnage).

Example: if 1520 CFM is the desired airflow the Tonnage Selection that matches this is 3.8

Enter the Tonnage (ton) menu either by using the on board push buttons or phone application and select the Tonnage Selection you identified.

NOTE: Trim is also available if additional adjustment is required.

CHECKING HEATER LIMIT CONTROL(S)

Each individual heater element is protected with a limit control device connected in series with each element to prevent overheating of components in case of low airflow. This limit control will open its circuit at approximately 150°F.

WARNING

HIGH VOLTAGE!
DISCONNECT ALL POWER BEFORE SERVICING OR INSTALLING. MULTIPLE POWER SOURCES MAY BE PRESENT. FAILURE TO DO SO MAY CAUSE PROPERTY DAMAGE, PERSONAL INJURY OR DEATH.



1. Remove the wiring from the control terminals.
2. Using an ohmmeter, test for continuity across the normally closed contacts. No reading indicates the control is open - replace if necessary.

IF FOUND OPEN - REPLACE - DO NOT WIRE AROUND.

CHECKING HEATER FUSE LINK (OPTIONAL ELECTRIC HEATERS)

Each individual heater element is protected with a one time fuse link which is connected in series with the element. The fuse link will open at approximately 333°.

SERVICING



WARNING

DISCONNECT ALL POWER BEFORE SERVICING.

1. Remove heater element assembly so as to expose fuse link.
2. Using an ohmmeter, test across the fuse link for continuity - no reading indicates the link is open. Replace as necessary.

NOTE: The link is designed to open at approximately 333°F. DO NOT WIRE AROUND - determine reason for failure.

CHECKING HEATER ELEMENTS



WARNING

DISCONNECT ALL POWER BEFORE SERVICING.

1. Disassemble and remove the heating element.
2. Visually inspect the heater assembly for any breaks in the wire or broken insulators.
3. Using an ohmmeter, test the element for continuity - no reading indicates the element is open. Replace as necessary.

REFRIGERATION REPAIR PRACTICE



DANGER

ALWAYS REMOVE THE REFRIGERANT CHARGE IN A PROPER MANNER BEFORE APPLYING HEAT TO THE SYSTEM.

When repairing the refrigeration system:



WARNING

HIGH VOLTAGE!
DISCONNECT ALL POWER BEFORE SERVICING OR INSTALLING. MULTIPLE POWER SOURCES MAY BE PRESENT. FAILURE TO DO SO MAY CAUSE PROPERTY DAMAGE, PERSONAL INJURY OR DEATH.



1. Never open a system that is under vacuum. Air and moisture will be drawn in.
2. Plug or cap all openings.
3. Remove all burrs and clean the brazing surfaces of the tubing with sand cloth or paper. Brazing materials do not flow well on oxidized or oily surfaces.
4. Clean the inside of all new tubing to remove oils and pipe chips.

5. When brazing, sweep the tubing with dry nitrogen to prevent the formation of oxides on the inside surfaces.
6. Complete any repair by replacing the liquid line drier in the system, evacuate and charge.

BRAZING MATERIALS

IMPORTANT NOTE: Torch heat required to braze tubes of various sizes is proportional to the size of the tube. Tubes of smaller size require less heat to bring the tube to brazing temperature before adding brazing alloy. Applying too much heat to any tube can melt the tube. Service personnel must use the appropriate heat level for the size of the tube being brazed.

NOTE: The use of a heat shield when brazing is recommended to avoid burning the serial plate or the finish on the unit. Heat trap or wet rags should be used to protect heat sensitive components such as service valves and TXV valves.

Copper to Copper Joints - Sil-Fos used without flux (alloy of 15% silver, 80% copper, and 5% phosphorous). Recommended heat 1400°F.

Copper to Steel Joints - Silver Solder used without a flux (alloy of 30% silver, 38% copper, 32% zinc). Recommended heat - 1200°F.

LEAK TESTING (NITROGEN OR NITROGEN-TRACED)



WARNING

TO AVOID THE RISK OF FIRE OR EXPLOSION, NEVER USE OXYGEN, HIGH PRESSURE AIR OR FLAMMABLE GASES FOR LEAK TESTING OF A REFRIGERATION SYSTEM.



WARNING

TO AVOID POSSIBLE EXPLOSION, THE LINE FROM THE NITROGEN CYLINDER MUST INCLUDE A PRESSURE REGULATOR AND A PRESSURE RELIEF VALVE. THE PRESSURE RELIEF VALVE MUST BE SET TO OPEN AT NO MORE THAN 450 PSIG.

Leak test the system using dry nitrogen and soapy water to identify leaks. If you prefer to use an electronic leak detector, charge the system to 10 PSIG with the appropriate system refrigerant (see Serial Data Plate for refrigerant identification). Do not use an alternative refrigerant. Using dry nitrogen finish charging the system to 450 PSIG. Apply the leak detector to all suspect areas. When leaks are discovered, repair the leaks, and repeat the pressure test. If leaks have been eliminated proceed to system evacuation.

SERVICING

SYSTEM EVACUATION

Condensing unit liquid and suction valves are closed to contain the charge within the unit. The unit is shipped with the valve stems closed and caps installed. Do not open valves until the system is evacuated.



WARNING

REFRIGERANT UNDER PRESSURE!
FAILURE TO FOLLOW PROPER PROCEDURES MAY CAUSE PROPERTY DAMAGE, PERSONAL INJURY OR DEATH.

NOTE: Scroll compressors should never be used to evacuate or pump down a heat pump or air conditioning system.



CAUTION

PROLONGED OPERATION AT SUCTION PRESSURES LESS THAN 20 PSIG FOR MORE THAN 5 SECONDS WILL RESULT IN OVERHEATING OF THE SCROLLS AND PERMANENT DAMAGE TO THE SCROLL TIPS, DRIVE BEARINGS AND INTERNAL SEAL.

DEEP VACUUM METHOD (RECOMMENDED)

The Deep Vacuum Method requires a vacuum pump rated for 500 microns or less. This method is an effective and efficient way of assuring the system is free of non-condensable air and moisture. As an alternative, the Triple Evacuation Method is detailed in the Service Manual for this product model.

It is recommended to remove the Schrader Cores from the service valves using a core-removal tool to expedite the evacuation procedure.

1. Connect the vacuum pump, micron gauge, and vacuum rated hoses to both service valves. Evacuation must use both service valves to eliminate system mechanical seals.
2. Evacuate the system to less than 500 microns.
3. Isolate the pump from the system and hold vacuum for 10 minutes (minimum). Typically, pressure will rise slowly during this period. If the pressure rises to less than 1000 microns and remains steady, the system is considered leak-free; proceed to system charging and startup.
4. If pressure rises above 1000 microns but holds steady below 2000 microns, non-condensable air or moisture may remain or a small leak is present. Return to step 2: If the same result is achieved check for leaks and repair. Repeat the evacuation procedure.
5. If pressure rises above 2000 microns, a leak is present. Check for leaks and repair. Repeat the evacuation procedure.

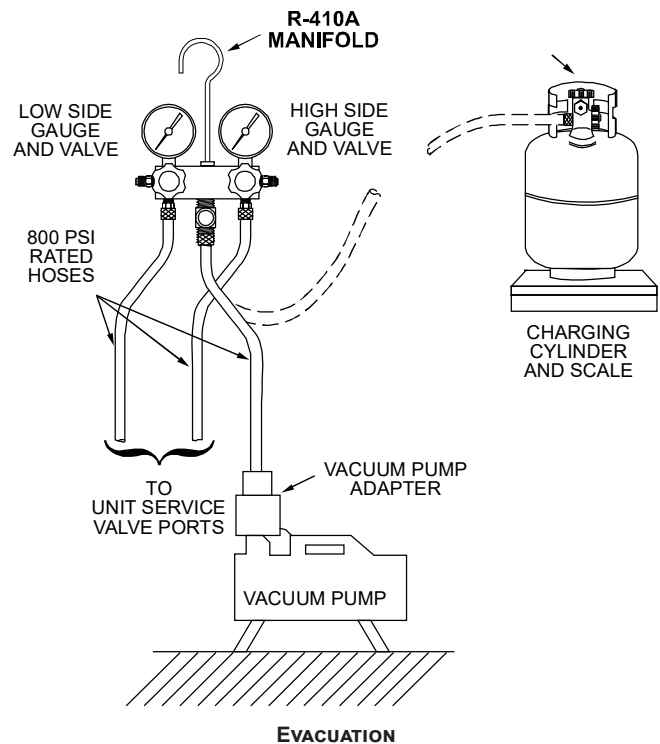
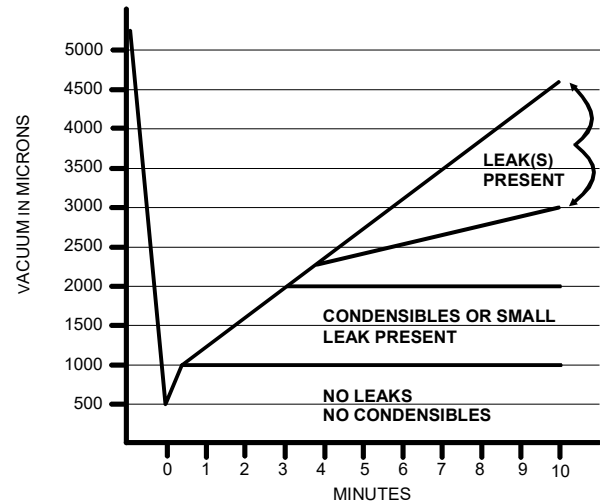



TRIPLE EVACUATION METHOD (ALTERNATE)

1. Evacuate the system to 4000 microns and hold for 15 minutes. Break the vacuum with dry nitrogen, bring the system pressure to 2-3 PSIG, and hold for 20 minutes. Release the nitrogen,
2. Evacuate to 1500 microns and hold for 20 minutes. Break the vacuum with dry nitrogen again, bring the system pressure back to 2-3 PSIG, and hold for 20 minutes.
3. Evacuate the system to 500 microns and hold for 60 minutes.
4. If the pressure rises to 1000 microns or less and remains steady the system is considered leak free; proceed to start-up.

SERVICING

CHARGING

 WARNING
REFRIGERANT UNDER PRESSURE! <ul style="list-style-type: none">• DO NOT OVERCHARGE SYSTEM WITH REFRIGERANT.• DO NOT OPERATE UNIT IN A VACUUM OR AT NEGATIVE PRESSURE. FAILURE TO FOLLOW PROPER PROCEDURES MAY CAUSE PROPERTY DAMAGE, PERSONAL INJURY OR DEATH.
 CAUTION
USE REFRIGERANT CERTIFIED TO AHRI STANDARDS. USED REFRIGERANT MAY CAUSE COMPRESSOR DAMAGE AND IS NOT COVERED UNDER THE WARRANTY. MOST PORTABLE MACHINES CANNOT CLEAN USED REFRIGERANT TO MEET AHRI STANDARDS.
 CAUTION
DAMAGE TO THE UNIT CAUSED BY OPERATING THE COMPRESSOR WITH THE SUCTION VALVE CLOSED IS NOT COVERED UNDER THE WARRANTY AND MAY CAUSE SERIOUS COMPRESSOR DAMAGE.

Charge the system with the exact amount of refrigerant. Refer to the specification section or check the unit nameplates for the correct refrigerant charge. An inaccurately charged system will cause future problems.

NOTE: R410A should be drawn out of the storage container or drum in liquid form due to its fractionation properties, but should be “Flashed” to its gas state before entering the system. There is commercially available restriction devices that fit into the system charging hose set to accomplish this. DO NOT charge liquid R410A into the compressor.

NOTE: Power must be supplied to the 18 SEER outdoor units containing ECM motors before the power is applied to the indoor unit. Sending a low voltage signal without high voltage power present at the outdoor unit can cause malfunction of the control module on the ECM motor.

Adequate refrigerant charge for the matching evaporator coil or air handler and 15 feet of line set is supplied with the condensing unit. If using evaporator coils or air handlers other than HSVTC coil it may be necessary to add or remove refrigerant to attain proper charge. If line set exceeds 15 feet in length, refrigerant should be added at .6 ounces per foot of liquid line.

NOTE: The outdoor temperature should be 60°F or higher when charging the unit. Charge should always be checked using subcooling when using TXV equipped indoor coil to verify proper charge.

When opening valves with retainers, open each valve only until the top of the stem is $\frac{1}{8}$ " from the retainer. To avoid loss of refrigerant, DO NOT apply pressure to the retainer. When opening valves without a retainer remove service valve cap and insert a hex wrench into the valve stem and back out the stem by turning the hex wrench counterclockwise. Open the valve until it contacts the rolled lip of the valve body.

NOTE: These are not back-seating valves. It is not necessary to force the stem tightly against the rolled lip.

Break vacuum by fully opening liquid service valve.

After the refrigerant charge has bled into the system, open the suction service valve. The service valve cap is the secondary seal for the valves and must be properly tightened to prevent leaks. Make sure cap is clean and apply refrigerant oil to threads and sealing surface on inside of cap. Tighten cap finger-tight and then tighten additional $\frac{1}{8}$ of a turn (1 wrench flat), or to the following specification, to properly seat the sealing surfaces.

EXPANSION VALVE SYSTEM

NOTE: Units matched with indoor coils equipped with non-adjustable TXV should be charged by subcooling only.

NOTE: The TXV should NOT be adjusted at light load conditions 55° to 60°F. Use the following guidelines and methods to check unit operation and ensure that the refrigerant charge is within limits. Charge the unit on low stage.

FINAL CHARGE ADJUSTMENT

Airflow and Total Static Pressure for the indoor unit should be verified before attempting to charge system.

1. Total static pressure is .5" WC or less.
2. Airflow is correct for installed unit.
3. Airflow tables are in the installation manual and Spec Sheet for Indoor Unit.
4. Complete charging information are in Service Manual RS6200006.

NOTE: Superheat adjustments should not be made until indoor ambient conditions have stabilized. This could take up to 24 hours depending on indoor temperature and humidity. Before checking superheat run the unit in cooling for 10-15 minutes or until refrigerant pressures stabilize. Use the following guidelines and methods to check unit operation and ensure that the refrigerant charge is within limits.

SERVICING

Units matched with indoor coils equipped with a non-adjustable TXV should be charged by Subcooling only. Superheat on indoor coils with adjustable TXV valves are factory set and no adjustment is normally required during startup. Only in unique applications due to refrigerant line length, differences in height between the indoor and outdoor unit and refrigerant tubing sizes or poor performance should Superheat setting require adjustment. These adjustments should only be performed by qualified service personnel. For detailed charge and TXV adjustments refer to the appropriate Service Manual.

Units Equipped with Adjustable Expansion Valves should be charged by Subcooling and Superheat adjusted only if necessary.

1. Purge gauge lines. Connect service gauge manifold to base-valve service ports. Run the system in low stage at least 10 minutes to allow pressure to stabilize.
2. Temporarily install a thermometer on the liquid line at the liquid line service valve and 4-6" from the compressor on the suction line. Ensure the thermometer makes adequate contact and is insulated for best possible readings. Use liquid line temperature to determine subcooling and vapor temperature to determine superheat.
3. Check subcooling and superheat. Systems with TXV application should have a subcooling of 5 to 7°F and superheat of 7 to 9 °F.
 - A. If subcooling and superheat are low, adjust TXV to 7 to 9 °F superheat, and then check subcooling.

NOTE: To adjust superheat, turn the valve stem clockwise to increase and counter clockwise to decrease.

- B. If subcooling is low and superheat is high, add charge to raise subcooling to 5 to 7 °F then check superheat.
- C. If subcooling and superheat are high, adjust TXV valve to 7 to 9 °F superheat, then check subcooling.
- D. If subcooling is high and superheat is low, adjust TXV valve to 7 to 9 °F superheat and remove charge to lower the subcooling to 5 to 7 °F.

NOTE: Do NOT adjust the charge based on suction pressure unless there is a gross undercharge.

4. Disconnect manifold set, installation is complete.

SUBCOOLING FORMULA = SATURATED LIQUID TEMP.
- LIQUID LINE TEMP.

NOTE: Check the Schrader ports for leaks and tighten valve cores if necessary. Install caps finger-tight.

HEAT PUMP - HEATING CYCLE

The proper method of charging a heat pump in the heat mode is by weight with the additional charge adjustments for line size, line length, and other system components. For best results on outdoor units with TXVs, superheat should be 8°F at 4-6" from the compressor. Make final charge adjustments in the cooling cycle.

CHECKING COMPRESSOR EFFICIENCY

The reason for compressor inefficiency is broken or damaged scroll flanks on Scroll compressors, reducing the ability of the compressor to pump refrigerant vapor.

The condition of the scroll flanks is checked in the following manner:

1. Attach gauges to the high and low side of the system.
2. Start the system and run a "Cooling Performance Test."

If the test shows:

- A. Below normal high side pressure.
- B. Above normal low side pressure.
- C. Low temperature difference across coil.
- D. Low amp draw at compressor.

And the charge is correct. The compressor is faulty - replace the compressor.

OVERFEEDING

Overfeeding by the expansion valve results in high suction pressure, cold suction line, and possible liquid slugging of the compressor.

If these symptoms are observed:

1. Check for an overcharged unit by referring to the cooling performance charts in the servicing section.
2. Check the operation of the power element in the valve as explained in Checking Expansion Valve Operation.
3. Check for restricted or plugged equalizer tube.

UNDERFEEDING

Underfeeding by the expansion valve results in low system capacity and low suction pressures.

If these symptoms are observed:

1. Check for a restricted liquid line or drier. A restriction will be indicated by a temperature drop across the drier.

SERVICING

2. Check the operation of the power element of the valve as described in Checking Expansion Valve Operation.

SUPERHEAT

The expansion valves are factory adjusted to maintain 7 to 9 degrees superheat of the suction gas. Before checking the superheat or replacing the valve, perform all the procedures outlined under Air Flow, Refrigerant Charge, Expansion Valve - Overfeeding, Underfeeding. These are the most common causes for evaporator malfunction.

CHECKING SUPERHEAT

Refrigerant gas is considered superheated when its temperature is higher than the saturation temperature corresponding to its pressure. The degree of superheat equals the degrees of temperature increase above the saturation temperature at existing pressure. See Temperature - Pressure Chart on following pages.



CAUTION

TO PREVENT PERSONAL INJURY, CAREFULLY CONNECT AND DISCONNECT MANIFOLD GAUGE HOSES. ESCAPING LIQUID REFRIGERANT CAN CAUSE BURNS. DO NOT VENT REFRIGERANT TO ATMOSPHERE. RECOVER DURING SYSTEM REPAIR OR FINAL UNIT DISPOSAL.

1. Run system at least 10 minutes to allow pressure to stabilize.
2. For best results, temporarily install a thermometer on the liquid line at the liquid line service valve and 4-6" from the compressor on the suction line. Ensure the thermometer makes adequate contact and is insulated for best possible readings. Use liquid line temperature to determine sub-cooling and vapor temperature to determine superheat.

NOTE: An optional method is to locate the thermometer at the suction line service valve. Ensure the thermometer makes adequate contact and is insulated for best possible readings.

3. Refer to the superheat table provided for proper system superheat. Add charge to lower superheat or recover charge to raise superheat.

Superheat Formula = Suct. Line Temp. - Sat. Suct. Temp.

EXAMPLE:

- A. Suction Pressure = 143
- B. Corresponding Temp. °F. = 50
- C. Thermometer on Suction Line = 61°F.

To obtain the degrees temperature of superheat, subtract 50.0 from 61.0°F.

The difference is 11° Superheat. The 11° Superheat would fall in the ± range of allowable superheat.

CHECKING SUBCOOLING

Refrigerant liquid is considered subcooled when its temperature is lower than the saturation temperature corresponding to its pressure. The degree of subcooling equals the degrees of temperature decrease below the saturation temperature at the existing pressure.

1. Attach an accurate thermometer or preferably a thermocouple type temperature tester to the liquid line as it leaves the condensing unit.
2. Install a high side pressure gauge on the high side (liquid) service valve at the front of the unit.
3. Record the gauge pressure and the temperature of the line.
4. Review the technical information manual or specification sheet for the model being serviced to obtain the design subcooling.
5. Compare the hi-pressure reading to the "Required Liquid Line Temperature" chart (page 108). Find the hi-pressure value on the left column. Follow that line right to the column under the design subcooling value. Where the two intersect is the required liquid line temperature.
Alternately you can convert the liquid line pressure gauge reading to temperature by finding the gauge reading in Temperature - Pressure Chart and reading to the left, find the temperature in the °F. Column.
6. The difference between the thermometer reading and pressure to temperature conversion is the amount of subcooling.

Add charge to raise subcooling. Recover charge to lower subcooling.

Subcooling Formula = Sat. Liquid Temp. - Liquid Line Temp.

EXAMPLE:

- A. Liquid Line Pressure = 417
- B. Corresponding Temp. °F. = 120°
- C. Thermometer on Liquid line = 109°F.

To obtain the amount of subcooling subtract 109°F from 120°F.

The difference is 11° subcooling. See the specification sheet or technical information manual for the design subcooling range for your unit.

SERVICING

CHECKING EXPANSION VALVE OPERATION

1. Remove the remote bulb of the expansion valve from the suction line.
2. Start the system and cool the bulb in a container of ice water, closing the valve. As you cool the bulb, the suction pressure should fall and the suction temperature will rise.
3. Next warm the bulb in your hand. As you warm the bulb, the suction pressure should rise and the suction temperature will fall.
4. If a temperature or pressure change is noticed, the expansion valve is operating. If no change is noticed, the valve is restricted, the power element is faulty, or the equalizer tube is plugged.
5. Capture the charge, replace the valve and drier, evacuate and recharge.

SERVICING

EXPANSION VALVE KITS

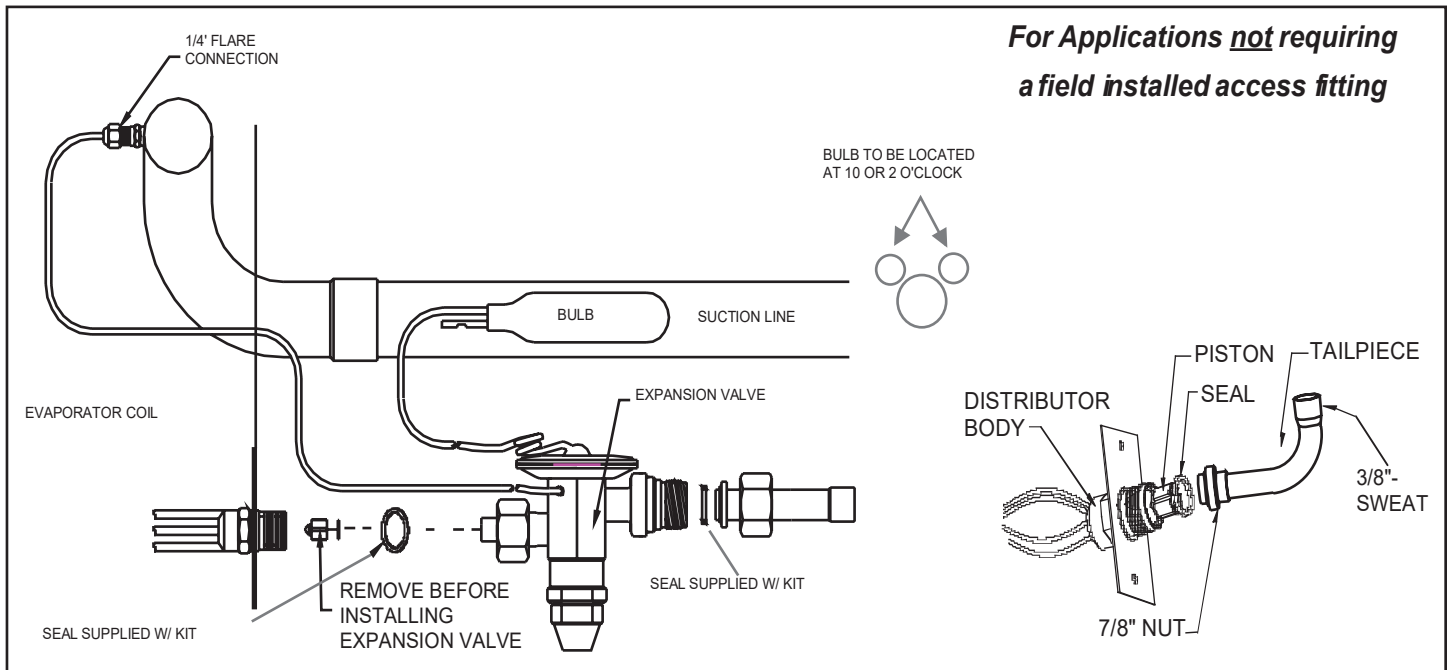
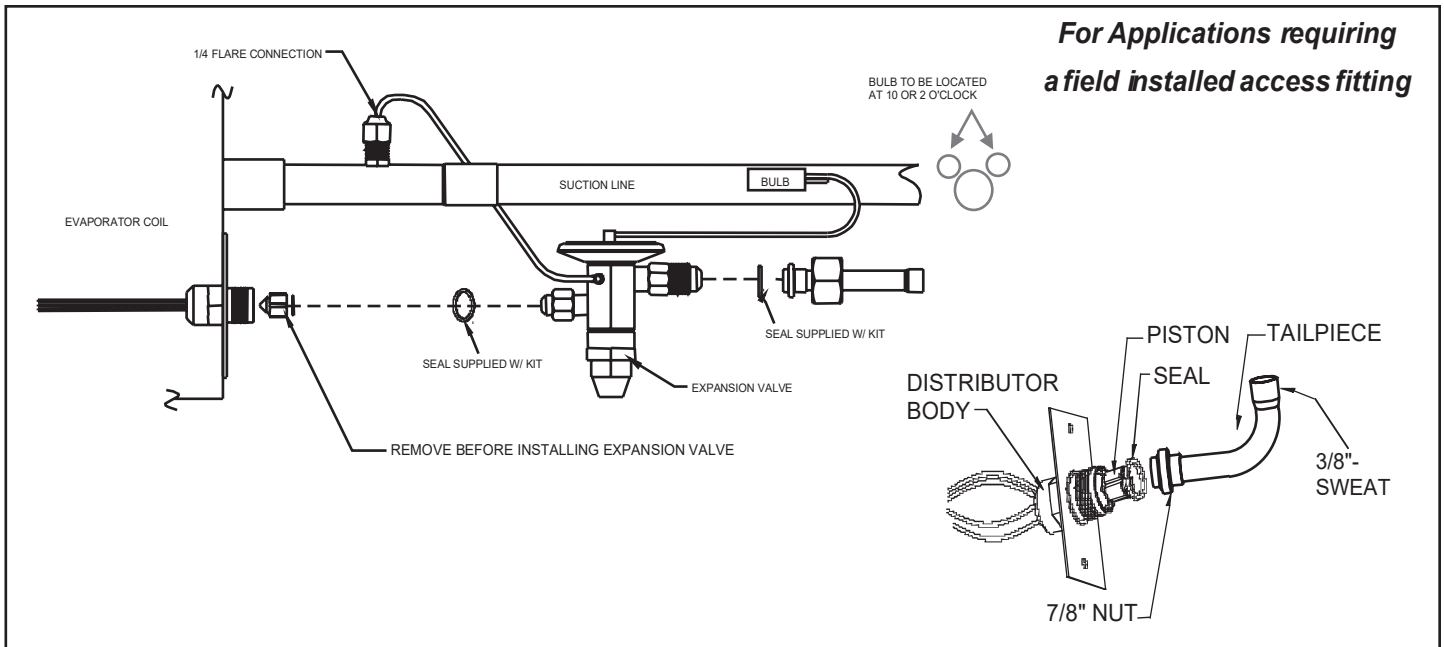

SERVICING

Pressure vs. Temperature Chart

R-410A

PSIG	°F	PSIG	°F	PSIG	°F	PSIG	°F	PSIG	°F	PSIG	°F
12	-37.7	114.0	37.8	216.0	74.3	318.0	100.2	420.0	120.7	522.0	137.6
14	-34.7	116.0	38.7	218.0	74.9	320.0	100.7	422.0	121.0	524.0	137.9
16	-32.0	118.0	39.5	220.0	75.5	322.0	101.1	424.0	121.4	526.0	138.3
18	-29.4	120.0	40.5	222.0	76.1	324.0	101.6	426.0	121.7	528.0	138.6
20	-36.9	122.0	41.3	224.0	76.7	326.0	102.0	428.0	122.1	530.0	138.9
22	-24.5	124.0	42.2	226.0	77.2	328.0	102.4	430.0	122.5	532.0	139.2
24	-22.2	126.0	43.0	228.0	77.8	330.0	102.9	432.0	122.8	534.0	139.5
26	-20.0	128.0	43.8	230.0	78.4	332.0	103.3	434.0	123.2	536.0	139.8
28	-17.9	130.0	44.7	232.0	78.9	334.0	103.7	436.0	123.5	538.0	140.1
30	-15.8	132.0	45.5	234.0	79.5	336.0	104.2	438.0	123.9	540.0	140.4
32	-13.8	134.0	46.3	236.0	80.0	338.0	104.6	440.0	124.2	544.0	141.0
34	-11.9	136.0	47.1	238.0	80.6	340.0	105.1	442.0	124.6	548.0	141.6
36	-10.1	138.0	47.9	240.0	81.1	342.0	105.4	444.0	124.9	552.0	142.1
38	-8.3	140.0	48.7	242.0	81.6	344.0	105.8	446.0	125.3	556.0	142.7
40	-6.5	142.0	49.5	244.0	82.2	346.0	106.3	448.0	125.6	560.0	143.3
42	-4.5	144.0	50.3	246.0	82.7	348.0	106.6	450.0	126.0	564.0	143.9
44	-3.2	146.0	51.1	248.0	83.3	350.0	107.1	452.0	126.3	568.0	144.5
46	-1.6	148.0	51.8	250.0	83.8	352.0	107.5	454.0	126.6	572.0	145.0
48	0.0	150.0	52.5	252.0	84.3	354.0	107.9	456.0	127.0	576.0	145.6
50	1.5	152.0	53.3	254.0	84.8	356.0	108.3	458.0	127.3	580.0	146.2
52	3.0	154.0	54.0	256.0	85.4	358.0	108.8	460.0	127.7	584.0	146.7
54	4.5	156.0	54.8	258.0	85.9	360.0	109.2	462.0	128.0	588.0	147.3
56	5.9	158.0	55.5	260.0	86.4	362.0	109.6	464.0	128.3	592.0	147.9
58	7.3	160.0	56.2	262.0	86.9	364.0	110.0	466.0	128.7	596.0	148.4
60	8.6	162.0	57.0	264.0	87.4	366.0	110.4	468.0	129.0	600.0	149.0
62	10.0	164.0	57.7	266.0	87.9	368.0	110.8	470.0	129.3	604.0	149.5
64	11.3	166.0	58.4	268.0	88.4	370.0	111.2	472.0	129.7	608.0	150.1
66	12.6	168.0	59.0	270.0	88.9	372.0	111.6	474.0	130.0	612.0	150.6
68	13.8	170.0	59.8	272.0	89.4	374.0	112.0	476.0	130.3	616.0	151.2
70	15.1	172.0	60.5	274.0	89.9	376.0	112.4	478.0	130.7	620.0	151.7
72	16.3	174.0	61.1	276.0	90.4	378.0	112.6	480.0	131.0	624.0	152.3
74	17.5	176.0	61.8	278.0	90.9	380.0	113.1	482.0	131.3	628.0	152.8
76	18.7	178.0	62.5	280.0	91.4	382.0	113.5	484.0	131.6	632.0	153.4
78	19.8	180.0	63.1	282.0	91.9	384.0	113.9	486.0	132.0	636.0	153.9
80	21.0	182.0	63.8	284.0	92.4	386.0	114.3	488.0	132.3	640.0	154.5
82	22.1	184.0	64.5	286.0	92.8	388.0	114.7	490.0	132.6	644.0	155.0
84	23.2	186.0	65.1	288.0	93.3	390.0	115.0	492.0	132.9	648.0	155.5
86	24.3	188.0	65.8	290.0	93.8	392.0	115.5	494.0	133.3	652.0	156.1
88	25.4	190.0	66.4	292.0	94.3	394.0	115.8	496.0	133.6	656.0	156.6
90	26.4	192.0	67.0	294.0	94.8	396.0	116.2	498.0	133.9	660.0	157.1
92	27.4	194.0	67.7	296.0	95.2	398.0	116.6	500.0	134.0	664.0	157.7
94	28.5	196.0	68.3	298.0	95.7	400.0	117.0	502.0	134.5	668.0	158.2
96	29.5	198.0	68.9	300.0	96.2	402.0	117.3	504.0	134.8	672.0	158.7
98	30.5	200.0	69.5	302.0	96.6	404.0	117.7	506.0	135.2	676.0	159.2
100	31.2	202.0	70.1	304.0	97.1	406.0	118.1	508.0	135.5	680.0	159.8
102	32.2	204.0	70.7	306.0	97.5	408.0	118.5	510.0	135.8	684.0	160.3
104	33.2	206.0	71.4	308.0	98.0	410.0	118.8	512.0	136.1	688.0	160.8
106	34.1	208.0	72.0	310.0	98.4	412.0	119.2	514.0	136.4	692.0	161.3
108	35.1	210.0	72.6	312.0	98.9	414.0	119.6	516.0	136.7	696.0	161.8
110	35.5	212.0	73.2	314.0	99.3	416.0	119.9	518.0	137.0		
112	36.9	214.0	73.8	316.0	99.7	418.0	120.3	520.0	137.3		

*Based on ALLIED SIGNAL Data

SERVICING

REQUIRED LIQUID LINE TEMPERATURE						
LIQUID PRESSURE AT SERVICE VALVE (PSIG)	REQUIRED SUBCOOLING TEMPERATURE (°F)					
	8	10	12	14	16	18
189	58	56	54	52	50	48
195	60	58	56	54	52	50
202	62	60	58	56	54	52
208	64	62	60	58	56	54
215	66	64	62	60	58	56
222	68	66	64	62	60	58
229	70	68	66	64	62	60
236	72	70	68	66	64	62
243	74	72	70	68	66	64
251	76	74	72	70	68	66
259	78	76	74	72	70	68
266	80	78	76	74	72	70
274	82	80	78	76	74	72
283	84	82	80	78	76	74
291	86	84	82	80	78	76
299	88	86	84	82	80	78
308	90	88	86	84	82	80
317	92	90	88	86	84	82
326	94	92	90	88	86	84
335	96	94	92	90	88	86
345	98	96	94	92	90	88
354	100	98	96	94	92	90
364	102	100	98	96	94	92
374	104	102	100	98	96	94
384	106	104	102	100	98	96
395	108	106	104	102	100	98
406	110	108	106	104	102	100
416	112	110	108	106	104	102
427	114	112	110	108	106	104
439	116	114	112	110	108	106
450	118	116	114	112	110	108
462	120	118	116	114	112	110
474	122	120	118	116	114	112
486	124	122	120	118	116	114
499	126	124	122	120	118	116
511	128	126	124	122	120	118

SERVICING

CHECKING RESTRICTED LIQUID LINE

When the system is operating, the liquid line is warm to the touch. If the liquid line is restricted, a definite temperature drop will be noticed at the point of restriction. In severe cases, frost will form at the restriction and extend down the line in the direction of the flow.

Discharge and suction pressures will be low, giving the appearance of an undercharged unit. However, the unit will have normal to high subcooling.

Locate the restriction, replace the restricted part, replace drier, evacuate and recharge.

OVERCHARGE OF REFRIGERANT

An overcharge of refrigerant is normally indicated by an excessively high head pressure.

An evaporator coil, using an expansion valve metering device, will basically modulate and control a flooded evaporator and prevent liquid return to the compressor.

An evaporator coil, using a capillary tube metering device, could allow refrigerant to return to the compressor under extreme overcharge conditions. Also with a capillary tube metering device, extreme cases of insufficient indoor air can cause icing of the indoor coil and liquid return to the compressor, but the head pressure would be lower.

There are other causes for high head pressure which may be found in the "Service Problem Analysis Guide."

If other causes check out normal, an overcharge or a system containing non-condensables would be indicated.

If this system is observed:

1. Start the system.
2. Remove and capture small quantities of gas from the suction line dill valve until the head pressure is reduced to normal.
3. Observe the system while running a cooling performance test. If a shortage of refrigerant is indicated, then the system contains non-condensables.

NON-CONDENSABLES

If non-condensables are suspected, shut down the system and allow the pressures to equalize. Wait at least 15 minutes. Compare the pressure to the temperature of the coldest coil since this is where most of the refrigerant will be. If the pressure indicates a higher temperature than that of the coil temperature, non-condensables are present.

Non-condensables are removed from the system by first removing the refrigerant charge, replacing and/or installing liquid line drier, evacuating and recharging.

CHECKING COMPRESSOR EFFICIENCY

The reason for compressor inefficiency is broken or damaged scroll flanks on Scroll compressors, reducing the ability of the compressor to pump refrigerant vapor. The condition of the scroll flanks is checked in the following manner.

1. Attach gauges to the high and low side of the system.
2. Start the system and run a "Cooling Performance Test". If the test shows:
 - A. Below normal high side pressure.
 - B. Above normal low side pressure.
 - C. Low temperature difference across coil.
 - D. Low amp draw at compressor.And the charge is correct. The compressor is faulty – replace the compressor.

COMPRESSOR BURNOUT

When a compressor burns out, high temperature develops causing the refrigerant, oil and motor insulation to decompose forming acids and sludge.

If a compressor is suspected of being burned-out, attach a refrigerant hose to the liquid line dill valve and properly remove and dispose of the refrigerant.

NOTICE

VIOLATION OF EPA REGULATIONS MAY RESULT IN FINES OR OTHER PENALTIES.

Now determine if a burn out has actually occurred. Confirm by analyzing an oil sample using a Sporlan Acid Test Kit, AK-3 or its equivalent.

Remove the compressor and obtain an oil sample from the suction stub. If the oil is not acidic, either a burnout has not occurred or the burnout is so mild that a complete clean-up is not necessary.

If acid level is unacceptable, the system must be cleaned by using the clean-up drier method.



CAUTION

DO NOT ALLOW THE SLUDGE OR OIL TO CONTACT THE SKIN. SEVERE BURNS MAY RESULT.

NOTE: The Flushing Method using R-11 refrigerant is no longer approved by Amana® Brand Heating-Cooling.

SERVICING

SUCTION LINE DRIER CLEAN-UP METHOD

The POE oils used with R410A refrigerant is an excellent solvent. In the case of a burnout, the POE oils will remove any burnout residue left in the system. If not captured by the refrigerant filter, they will collect in the compressor or other system components, causing a failure of the replacement compressor and/or spread contaminants throughout the system, damaging additional components.

Install a field supplied suction line drier. This drier should be installed as close to the compressor suction fitting as possible. The filter must be accessible and be rechecked for pressure drop after the system has operated for a time. It may be necessary to use new tubing and form as required.

NOTE: At least twelve (12) inches of the suction line immediately out of the compressor stub must be discarded due to burned residue and contaminants.

1. Remove compressor discharge line strainer.
2. Remove the liquid line drier and expansion valve.
3. Purge all remaining components with dry nitrogen or carbon dioxide until clean.
4. Install new components **including** liquid line drier.
5. Braze all joints, leak test, evacuate, and recharge system.
6. Start up the unit and record the pressure drop across the drier.
7. Continue to run the system for a minimum of twelve (12) hours and recheck the pressure drop across the drier. Pressure drop should not exceed 6 PSIG.
8. Continue to run the system for several days, repeatedly checking pressure drop across the suction line drier. If the pressure drop never exceeds the 6 PSIG, the drier has trapped the contaminants. Remove the suction line drier from the system.
9. If the pressure drop becomes greater, then it must be replaced and steps 5 through 9 repeated until it does not exceed 6 PSIG.

NOTICE: Regardless, the cause for burnout must be determined and corrected before the new compressor is started.

REFRIGERANT PIPING

The piping of a refrigeration system is very important in relation to system capacity, proper oil return to compressor, pumping rate of compressor and cooling performance of the evaporator.

POE oils maintain a consistent viscosity over a large temperature range which aids in the oil return to the compressor; however, there will be some installations which require oil return traps. These installations should be avoided whenever possible, as adding oil traps to the refrigerant lines also increases the opportunity for debris and moisture to be introduced into the system. Avoid long running traps in horizontal suction line.

ALUMINUM INDOOR COIL CLEANING (QUALIFIED SERVICER ONLY)

This unit is equipped with an aluminum tube evaporator coil. The safest way to clean the evaporator coil is to simply flush the coil with water. This cleaning practice remains as the recommended cleaning method for both copper tube and aluminum tube residential cooling coils.

An alternate cleaning method is to use one of the products listed in the technical publication **TP-109 (shipped in the literature bag with the unit)** to clean the coils. The cleaners listed are the only agents deemed safe and approved for use to clean round tube aluminum coils. TP-109 is available on the web site in Partner Link > Service Toolkit.

NOTE: Ensure coils are rinsed well after use of any chemical cleaners.

AIR HANDLER STATIC PRESSURE READINGS

SINGLE PIECE AIR HANDLER EXTERNAL STATIC PRESSURE

To determine proper airflow, proceed as follows:

1. Using a Inclined Manometer or Magnehelic gauge, measure the static pressure of the return duct at the inlet of the air handler, this will be a negative pressure (for example $-.30''\text{wc}$).
2. Measure the static pressure of the supply duct at the outlet of the air handler, this should be a positive pressure (for example $.20''\text{wc}$).
3. Add the two readings together (for example $-.30''\text{wc} + .20''\text{wc} = .50''\text{wc}$ total external static pressure).

NOTE: Both readings may be taken simultaneously and read directly on the manometer if so desired.

4. Consult proper air handler airflow chart for quantity of air (CFM) at the measured external static pressure.

SERVICING

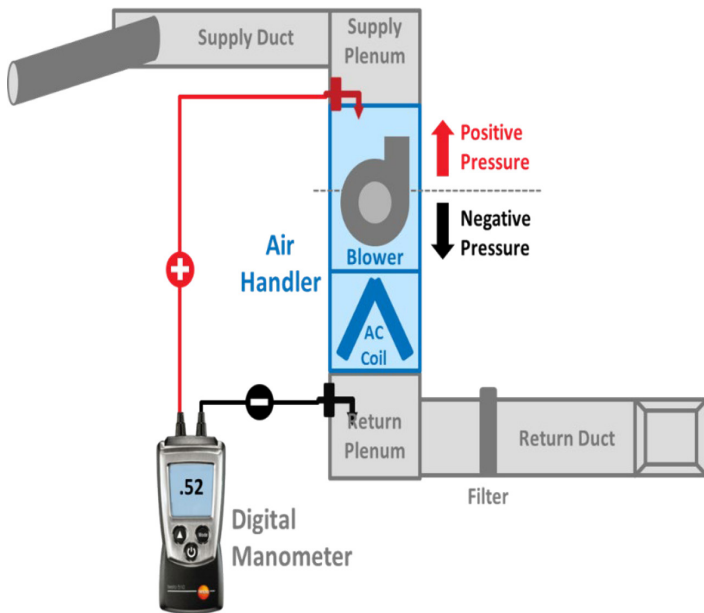

TWO PIECE AIR HANDLER EXTERNAL STATIC PRESSURE

To determine proper airflow, proceed as follows:

1. Using a Inclined Manometer or Magnehelic gauge, measure the static pressure between the outlet of the evaporator coil and the inlet of the air handler, this will be a negative pressure (for example $-.30''\text{wc}$).
2. Measure the static pressure of the supply duct at the outlet of the unit, this should be a positive pressure (for example $.20''\text{wc}$).
3. Add the two readings together (for example $-.30''\text{wc} + .20''\text{wc} = .50''\text{wc}$ total static pressure).

NOTE: Both readings may be taken simultaneously and read directly on the manometer if so desired.

4. Consult proper air handler airflow chart for quantity of air (CFM) at the measured external static pressure.

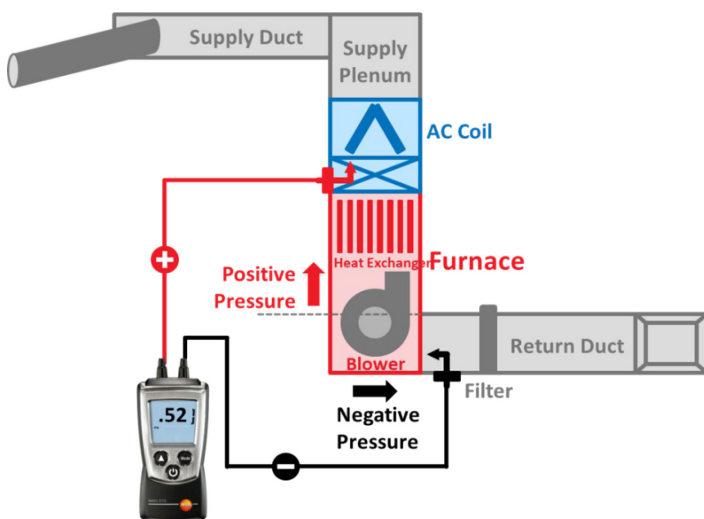

MAINTENANCE

MOTORS

Indoor and Outdoor motors are permanently lubricated and do not need additional oiling.

CLEANING OUTDOOR COIL

1. Check for oil deposits on coil this could be an indication of possible leak. If no leak detected spray coil with ordinary household detergent.
2. Using garden hose, spray coil vertically downward with constant stream of water at moderate pressure. Keep nozzle at a 15- to 20° angle, about 3 in. from coil face. Spray so debris is washed out of coil and base pan.
3. Reinstall top cover and position blade.
4. Reconnect electrical power and check for proper operation.

CLEANING OUTDOOR FAN BLADE

1. Check balance weights on fan blade.
2. Check fan blade setscrew for tightness.

ELECTRICAL CONTROLS AND WIRING

1. Disconnect power to both outdoor and indoor units.
2. Check all electrical connections for tightness.
3. Tighten all screws on electrical connections.
4. Connections that appear to be burned or smoky should be disassembled and cleaned all parts.
5. Wire connections that appear burned and corroded should be replaced and crimp tightly to assure they do not overheat.
6. Reconnect electrical power to indoor and outdoor units and check for proper operation.

CLEANING ALUMINUM COILS

Evaporator coils and air handlers are equipped with an aluminum tube evaporator coil. The safest way to clean the evaporator coil is to simply flush the coil with water. This cleaning practice remains as the recommended cleaning method for both copper tube and aluminum tube residential cooling coils.

An alternate cleaning method is to use one of the products listed in the technical publication TP-109 (shipped in the literature bag with the unit) to clean the coils. The cleaners listed are the only agents deemed safe and approved for use to clean round tube aluminum coils. TP-109 is available on the website in Partner Link > Service Toolkit.

NOTE: Ensure coils are rinsed well after use of any chemical cleaners.

SERVICING

AIR HANDLER TROUBLESHOOTING MATRIX (B*)

Symptoms of Abnormal Operation	Diagnostic / Status LED Codes	Fault Description	Possible Causes	Corrective Actions
No outdoor unit operations	EC1	Communication error with outdoor unit	Improper low voltage wiring between the indoor and outdoor unit Outdoor control board lost power during operation	Locate and correct improper low voltage wiring issue Identify reason outdoor control board lost power during operation
No Air Handler operation	E05	Open fuse	Short in low voltage wiring	Locate and correct short in low voltage wiring Replace fuse with 3-amp automotive type
No Air Handler operation	E0F	Auxiliary switch (condensate switch) open	High water level in the evaporation coil	Check evaporator drain pan, trap, piping
No Air Handler operation	Ed0	Data not yet on network	No network data	Populate shared data set using Bluetooth® Shared Data Loader BTSDL01
No Air Handler operation	Ed1	Invalid shared data	Air Handler blower does not contain an appropriate shared data set	Populate correct shared data using Bluetooth® Shared Data Loader BTSDL01
Operation different than expected or no operation	Ed4	Invalid shared data	Shared data set on Bluetooth® Shared Data Loader BTSDL01 has been rejected by integrated control module	Verify shared data set is correct for the specific model. Re-populate data using correct Bluetooth® Shared Data Loader BTSDL01 if required
No Air Handler operation	Eb0	Circulator blower motor not running with demand present	Loose or disconnected wiring connection at circulator motor power leads Open circuit in inductor or loose wiring connection at inductor (3/4 Hp and 1 Hp models only) Failed circulator blower motor	Tighten or correct wiring connection Verify continuous circuit through inductor. Replace if open or short circuit Check circulator blower motor
No Air Handler operation	Eb1	Integrated control module has lost communications with circulator blower motor	Loose wiring connection at circulator motor control leads Failed circulator blower motor Failed integrated control module	Tighten or correct wiring connection Check circulator blower motor, replace if necessary Check integrated control module, replace if necessary
No Air Handler operation	Eb2	Circulator blower motor horse power in shared data set does not match circulator blower motor horse power	Incorrect circulator blower motor in Air Handler Incorrect shared data set in integrated control module	Verify circulator blower if motor horse power is the same specified for the specific Air Handler model, replace if necessary Verify shared data set is correct for the specific model, re-populate data using correct Bluetooth® Shared Data Loader BTSDL01 if required
Air Handler operates at reduced performance Airflow delivered is less than expected	Eb3	Circulator blower motor is operating in a power, temperature, or speed limiting condition	Blocked filters Restrictive or undersized ductwork High ambient temperatures	Check filters for blockage, clean filters or remove obstruction Check ductwork for blockage, remove obstruction and verify all registers are fully open Verify ductwork is appropriately sized for system and resize/replace as needed

SERVICING

AIR HANDLER TROUBLESHOOTING MATRIX (B*)

Symptoms of Abnormal Operation	Diagnostic / Status LED Codes	Fault Description	Possible Causes	Corrective Actions
No Air Handler operation	Eb4	Circulator blower motor senses a loss of rotor control Circulator blower motor senses high current	Abnormal motor loading, sudden change in speed or torque, sudden blockage of air handler air inlet or outlet	Check filters, filter grills/registers, duct system and air handler inlet/outlet for blockages
No Air Handler operation	Eb5	Circulator blower motor fails to start 10 consecutive times	Obstruction in circulator blower housing Seized Circulator blower motor bearings Failed circulator blower motor	Check circulator blower for obstructions Remove and repair/replace wheel/motor if necessary Check circulator blower motor shaft rotation and motor, replace motor if necessary
No Air Handler operation	Eb6	Circulator blower motor shuts down for over or under voltage condition Circulator blower motor shuts down due to over temperature condition on power module	High or low AC line voltage to air handler High ambient temperatures	Check power to air handler Verify line voltage is within the range specified on the rating plate
No Air Handler operation	Eb7	Circulator blower motor does not have enough information to operate properly Motor fails to start 40 consecutive times	Error with integrated control module shared data	Verify control is populated with the correct shared data
Air Handler operates at reduced performance or operates on low stage when high stage is expected	Eb9	Airflow is lower than demanded	Blocked filters or restrictive ductwork Undersized ductwork	Check filters for blockage, clean filters or remove obstruction Check ductwork for blockage, remove obstruction and verify all registers are fully open Verify ductwork is appropriately sized for system, resize/replace ductwork if necessary

SERVICING

AIR HANDLER DISPLAY (B*)

LED Display	Menu Description
L6F	View 6 most recent fault codes and Clear Fault Codes if desired (furnace)
Lrn	Restart communications between the indoor and outdoor unit.
Cr	Control Firmware Revision Number
Sr	Control Shared Data Revision Number
F5d	Constant Fan Speed as percent of maximum airflow. Default = 30%
EHe	Electric Heater Kit Wattage (kW)
EFd	Electric Heat Off Delay (seconds)
End	Electric Heat On Delay (seconds)
EEF	Electric Heat Airflow Trim (percentage)
Est	Percentage of high stage electric heating airflow to run during low stage electric heat operation
CF5	1 = system will try to satisfy the thermostat quickly. 5 (default) = system will try to satisfy the thermostat more slowly.
dHL	Select "Hi" to enable dehumidification when the thermostat DH terminal is energized. Select "Lo" to enable dehumidification when the thermostat DH terminal is de-energized. (default = Hi)
QdS	Select number of stages for the non-communicating outdoor unit. (ARC for single-stage Air Conditioners, IHP for single stage Heat Pumps, 2AC for two stage Air Conditioners or 2HP for two stage heat pumps)
ton	Indoor Airflow for non-communicating outdoor units. (values based on 400CFM per ton) (default = 3.0 Ton)
CTF	Cooling Airflow Trim (default 0%)
CRP	Cooling Airflow Profile setting (default = profile D shown as 4)
Cnd	Cooling Airflow On Delay Time (default = 5 seconds)
CFd	Cooling Airflow Off Delay Time. (default = 60 seconds)
CSt	Percentage of high stage cooling airflow to run during low stage operation. (default = 70%)
dHS	Electric heat operation during defrost. 1 = low stage 2 (default) = high stage
HtF	Heat Pump Indoor Airflow Trim (default = 0%)
HFd	Heat Pump Heating Airflow Off Delay Time (default = 60 seconds)
Hnd	Heat Pump Heating Airflow On Delay Time (default = 5 seconds)
HSt	Percentage of high stage heat pump heating airflow to run during low stage operation. (default = 70%)
EHR	When heat pump heating and electric heat are running at the same time, this percentage is used for additional airflow trim
dHE	Enables or disables dehumidification feature in the outdoor unit. (default = Enabled)
CbP	Balance point temperature. The Compressor will not operate below temperature. (Default = 0°F)
EbP	Backup Heat Balance Points
Hdl	Compressor run time between defrost cycles. (default = 30 minutes) (2 stage units)
CdL	Compressor off delay at the beginning and end of a defrost cycle. (default = 30 seconds)

LED Display	Menu Description
FCL	View 6 most recent fault codes and Clear Fault Codes if desired (outdoor communicating units)
t9t	Menu is enabled if the CF5 menu is set to 6. Select the target time the system will attempt to satisfy the thermostat.
SUP	Menu is enabled if the CF5 menu is set to 6. Select the percentage past the target time when the system will enable electric heat operation during heat mode.
0tt	Menu is enabled if the CF5 is set to 6. (Electric heat will run during the next heat call if the heat pump fails to satisfy the custom target time for this number of consecutive cycles) (default = 20 cycles)
utt	Menu is enabled if the CF5 menu is set to 6. (if the addition of low stage electric heat is able to consecutively satisfy the thermostat under the set target time for this number of cycles, the system will transition to the heat pump for primary heating)
5dP	Menu is enabled if the CF5 menu is set to 6. (this percentage will help determine when switching back to heat pump only operation is appropriate. Default = 20%. If target time = 20 minutes, the addition of low stage electric heat must staisfy the thermostat by less than 16 minutes. (target time - 20% default = 16 minutes).

SERVICING

AIR HANDLER DISPLAY (B*)

LED Display	Description of System Status
<i>IDL</i>	Idle
<i>FAN</i>	Constant Fan
<i>AC</i>	Compressor Cooling, Single-Stage (non-comm units)
<i>1AC</i>	Compressor Cooling, Low Stage (non-comm units)
<i>2AC</i>	Compressor Cooling, High Stage (non-comm units)
<i>AC 1</i>	Compressor Cooling, Low Stage (comm units)
<i>AC 2</i>	Compressor Cooling, High Stage (comm units)
<i>HP</i>	Compressor Heat, Single Stage (non-comm units)
<i>1AC</i>	Compressor Heat, Low Stage (non-comm units)
<i>2AC</i>	Compressor Heat, High Stage (non-comm units)
<i>HP 1</i>	Compressor Heat, Low Stage (comm Units)
<i>HP 2</i>	Compressor Heat, High Stage (comm Units)
<i>HE</i>	Electric Heat, Single Stage
<i>HE 1</i>	Electric Heat, Single Stage
<i>HE 2</i>	Electric Heat, High Stage
<i>*dFE</i>	Defrost, Single Stage Electric Heat (non-comm units)
<i>dF 1</i>	Defrost, Low Stage Electric Heat
<i>dF 2</i>	Defrost, High Stage Electric Heat
<i>dHU</i>	Dehumidification

*If a system is a heat pump connected legacy, then a DFT will show on the board in 2 instances.

1. If the heat pump calls for a defrost, Y and a W will be energized resulting in a DFT code on the air handler display.
2. If the heat pump calls for auxiliary heat, Y and a W will be energized resulting in a DFT code on the air handler display.

Menu Navigation and Selection Instructions

Using Phone Application over Bluetooth Network:

- 1) Connect to the air handler (instructions provided by phone during connection process).
- 2) Select desired settings menu
- 3) Select item that requires adjustment and make necessary selection
- 4) Submit Changes

Using On-Board Push Buttons:

- 1) Use the Right and Left Buttons to scroll between menus
- 2) Use the Center Button to select desired menu when menu code is shown on 7-segment displays
- 3) Use the Left and Right Buttons to scroll through options within the desired menu (the display will flash while scrolling through options for selection)
- 4) Use the Center Button to select the displayed option (when selected the display will stop flashing)
- 5) Use the Center Button to finalize selection and return to the main menu

Profiles	Pre-Run	Short-Run	OFF Delay
1	-----	-----	60 sec/100%
2	-----	30 sec/50%	60 sec/100%
3	-----	7.5 min/82%	60 sec/100%
4	30 sec/50%	7.5 min/82%	60 sec/100%

Airflow Settings Instructions

- 1) For non-communicating installations, select the type of unit installed in the OdS menu (1AC = single-stage air conditioner, 1HP = single-stage heat pump, 2AC = 2 stage air conditioner, 2HP = 2 stage heat pump) Default = OFF (no outdoor unit).
- 2) Use the Tonnage Menu (ton) to select Cooling/Heat Pump Airflow (non-communicating installation). Tonnage selection options and corresponding airflow CFM can be found to the right.
[Airflow = Tonnage Selection x 400] Default selection is 6.0 tons.
- 3) [Optional] Use the Cooling Trim Menu (CtF) to adjust the cooling airflow from -10% to +10% (2% increments). This applies for 2 stage communicating outdoor units and single or 2 stage non-communicating outdoor units.
- 4) [Optional] Use the Heating Trim Menu (HtF) to adjust the heat pump airflow from -10% to +10% (2% increments). This applies for 2 stage communicating outdoor units and single or 2 stage non-communicating outdoor units.
- 5) [Optional] Use the Constant Fan Menu (FSD) to select the percentage of maximum airflow for continuous fan
- 6) [Optional] Use the Cooling Airflow Profile Menu (CAP) to select between 5 cooling airflow profiles. Profile options 1-4 are listed above (option 5 is adjustable). See installation manual for further details

Tonnage Menu (ton)

Tonnage Selection	Airflow	Tonnage Selection	Airflow
1.0	400	3.5	1400
1.1	440	3.6	1440
1.2	480	3.7	1480
1.3	520	3.8	1520
1.4	560	3.9	1560
1.5	600	4.0	1600
1.6	640	4.1	1640
1.7	680	4.2	1680
1.8	720	4.3	1720
1.9	760	4.4	1760
2.0	800	4.5	1800
2.1	840	4.6	1840
2.2	880	4.7	1880
2.3	920	4.8	1920
2.4	960	4.9	1960
2.5	1000	5.0	2000
2.6	1040	5.1	2040
2.7	1080	5.2	2080
2.8	1120	5.3	2120
2.9	1160	5.4	2160
3.0	1200	5.5	2200
3.1	1240	5.6	2240
3.2	1280	5.7	2280
3.3	1320	5.8	2320
3.4	1360	5.9	2360
3.5	1400	6.0	2400

Maximum Airflow Output

AVPTC25B14 AVPTC29B14 AVPTC35B14 AVPTC37B14	AVPTC33C14	AVPTC31C14 AVPTC37C14 AVPTC39C14	AVPTC37D14 AVPTC49C14	AVPTC49D14 AVPTC59C14	AVPTC59D14 AVPTC61D14
1200	1300	1600	1800	1900	2100

*If airflow is set above the model's maximum value, the output will be the maximum value

Electric Heat Airflow Table

Htr Kw	AVPTC25B14	AVPTC29B14	AVPTC35B14 AVPTC37B14	AVPTC31C14	AVPTC33C14	AVPTC37C14 AVPTC39C14	AVPTC49C14 AVPTC59C14	AVPTC37D14	AVPTC49D14 ++	AVPTC59D14	AVPTC61D14 +++
3	550	550	550	600	600	NR	NR	NR	NR	NR	NR
5	650	650	650	700	700	700	800	870	950	990	1030
6	700	700	700	770	750	770	800	970	1060	1110	1150
8	800	800	800	880	850	880	950	1060	1150	1200	1250
10	850	875	875	970	920	970	1090	1120	1220	1270	1320
15	875	875	1050	1090	950	1090	1290	1220	1520	1520	1650
19	NR	NR	NR	1280	NR	1280	1345	NR	NR	NR	NR
20	NR	NR	NR	NR	NR	NR	NR	1250	NR	1520	1690
21	NR	NR	NR	NR	NR	NR	NR	NR	NR	NR	NR
25	NR	NR	NR	NR	NR	NR	NR	NR	NR	NR	1750

Selecting Heater Kit: Use the Electric Heating Wattage Menu (EHT) to select heater kit size. See "Menu Navigation and Selection Instructions" above. Default selection is 0 (No Heat Kit). Select installed heater kit for heater kit operation.

NR - Not Rated

++ For match up with a 3 ton outdoor unit: Airflow for 5kW up to 15kW heater kits shall be set to 1220 CFM by selecting 10 in the Electric Heating Wattage (EHT) menu.

+++ For match up with a 3.5 ton outdoor unit: Heater kit application shall not exceed 20 kW. Airflow for 5kW up to 20kW heater kits shall be set to 1500 CFM by selecting 8 in the Electric Heating Wattage (EHT) menu.



0140A00615-C

Symptoms of Abnormal Operation		Diagnostic/Status LED Codes			Fault Description	Possible Causes	Corrective Actions	Notes & Cautions
		Green	Yellow	Red				
<ul style="list-style-type: none"> • Very long run time. • Four consecutive compressor protector trips with average run time between trips greater than 3 hours. • Compressor operating at high speed and outdoor fan operating at low speed • Integrated control module diagnostic/status LED's display the indicated code. 	OFF	1 Flash	OFF	ON if call present; OFF if no call	<ul style="list-style-type: none"> • Low Side Fault. 	<ul style="list-style-type: none"> • Low refrigerant charge. • Restriction in liquid line. • Indoor blower motor failure. • Indoor thermostat set extremely low. 	<ul style="list-style-type: none"> • Verify refrigerant charge; adjust as needed. • Check for restricted liquid line; repair/replace as needed. • Check indoor blower motor; repair/replace as needed. • Check indoor thermostat setting. 	<ul style="list-style-type: none"> • Turn power OFF prior to repair. • Fault will clear after 30 consecutive normal cycles. • Fault may be cleared by cycling 24VAC to control. • Replace with correct replacement part(s).
<ul style="list-style-type: none"> • Compressor and outdoor fan are off. • Thermostat demand is present. • Integrated control module diagnostic/status LED's display the indicated code. 	ON	1 Flash	OFF	ON if call present; OFF if no call	<ul style="list-style-type: none"> • Low Pressure • CO Trip. 	<ul style="list-style-type: none"> • Low refrigerant charge. • Restriction in liquid line. • Indoor blower motor failure. • Indoor thermostat set extremely low. 	<ul style="list-style-type: none"> • Verify refrigerant charge; adjust as needed. • Check for restricted liquid line; repair/replace as needed. • Check indoor blower motor; repair/replace as needed. • Check low pressure switch; repair/replace as needed. • Check indoor thermostat setting. 	<ul style="list-style-type: none"> • Turn power OFF prior to repair. • Replace with correct replacement part(s).
<ul style="list-style-type: none"> • Compressor and outdoor fan are off. • Low pressure switch trip 3 times within same thermostat demand. • Thermostat demand is present. • Integrated control module diagnostic/status LED's display the indicated code. 	ON	1 Flash	ON	ON if call present; OFF if no call	<ul style="list-style-type: none"> • LPCO Lockout (3 Trips). 	<ul style="list-style-type: none"> • Low refrigerant charge. • Restriction in liquid line. • Indoor blower motor failure. • Indoor thermostat set extremely low. 	<ul style="list-style-type: none"> • Verify refrigerant charge; adjust as needed. • Check for restricted liquid line; repair/replace as needed. • Check indoor blower motor; repair/replace as needed. • Check low pressure switch; repair/replace as needed. • Check indoor thermostat setting. 	<ul style="list-style-type: none"> • Turn power OFF prior to repair. • Must clear fault by cycling 24VAC to control. • Replace with correct replacement part(s).

Symptoms of Abnormal Operation	Diagnostic/Status LED Codes			Fault Description	Possible Causes	Corrective Actions	Notes & Cautions
	Green	Yellow	Red				
<ul style="list-style-type: none"> Four consecutive compressor protector trips with average run time between trips greater than 1 minute and less than 15 minutes. Low pressure and high pressure switches are closed. Integrated control module diagnostic/status LED's display the indicated code. 	OFF	2 Flashes	OFF	<ul style="list-style-type: none"> High Side Fault 	<ul style="list-style-type: none"> Blocked condenser coil. Outdoor fan not running. 	<ul style="list-style-type: none"> Check and clean condenser coil. Check outdoor fan motor; repair/replace as needed. Check outdoor fan motor wiring; repair/replace as needed. Check outdoor fan motor capacitor; replace as needed. 	<ul style="list-style-type: none"> Turn power OFF prior to repair. Fault will clear after 4 consecutive normal cycles. Fault may be cleared by cycling 24VAC to control. Replace with correct replacement part(s).
<ul style="list-style-type: none"> Compressor and outdoor fan are off. Thermostat demand is present. Integrated control module diagnostic/status LED's display the indicated code. 	ON	2 Flashes	OFF	<ul style="list-style-type: none"> High Pressure CO Trip 	<ul style="list-style-type: none"> Blocked condenser coil. Outdoor fan not running. 	<ul style="list-style-type: none"> Check and clean condenser coil. Check outdoor fan motor; repair/replace as needed. Check outdoor fan motor wiring; repair/replace as needed. Check outdoor fan motor capacitor; replace as needed. 	<ul style="list-style-type: none"> Turn power OFF prior to repair. Replace with correct replacement part(s).
<ul style="list-style-type: none"> Compressor and outdoor fan are off. Low pressure switch trip 3 times within same thermostat demand. Thermostat demand is present. Integrated control module diagnostic/status LED's display the indicated code. 	ON	2 Flashes	ON	<ul style="list-style-type: none"> HPCO Lockout (3 Trips) 	<ul style="list-style-type: none"> Blocked condenser coil. Outdoor fan not running. 	<ul style="list-style-type: none"> Check and clean condenser coil. Check outdoor fan motor; repair/replace as needed. Check outdoor fan motor wiring; repair/replace as needed. Check outdoor fan motor capacitor; replace as needed. 	<ul style="list-style-type: none"> Turn power OFF prior to repair. Must clear fault by cycling 24VAC to control. Replace with correct replacement part(s).
<ul style="list-style-type: none"> Run time for last 4 cycles is less than 3 minutes each. Compressor protector has not tripped. Low pressure and high pressure switches are closed. Integrated control module diagnostic/status LED's display the indicated code. 	OFF	3 Flashes	OFF	<ul style="list-style-type: none"> Short Cycling 	<ul style="list-style-type: none"> Intermittent thermostat demand. Faulty compressor relay. 	<ul style="list-style-type: none"> Check thermostat and thermostat wiring; repair/replace as needed. Check compressor relay operation; replace control as needed. 	<ul style="list-style-type: none"> Turn power OFF prior to repair. Fault will clear after 4 consecutive normal cycles. Fault may be cleared by cycling 24VAC to control. Replace with correct replacement part(s).

Symptoms of Abnormal Operation	Diagnostic/Status LED Codes			Fault Description	Possible Causes	Corrective Actions	Notes & Cautions
	Green	Yellow	Red				
<ul style="list-style-type: none"> Compressor and outdoor fan are off. Compressor protector trips four consecutive times. Average run time between trips is less than 15 seconds. Integrated control module diagnostic/status LED's display the indicated code. 	OFF	4 Flashes	ON ON if call present; OFF if no call	<ul style="list-style-type: none"> Locked Rotor 	<ul style="list-style-type: none"> Compressor bearings are seized. Failed compressor run capacitor. Faulty run capacitor wiring. Low line voltage. 	<ul style="list-style-type: none"> Check compressor operation; repair/replace as needed. Check run capacitor; replace as needed. Check wiring; repair/replace as needed. Verify line voltage is within range on rating plate; contact local utility is out of range. 	<ul style="list-style-type: none"> Turn power OFF prior to repair. Must clear fault by cycling 24VAC to control. Replace with correct replacement part(s).
<ul style="list-style-type: none"> Compressor and outdoor fan are off for greater than 4 hours. Low pressure and high pressure switches are closed. Integrated control module diagnostic/status LED's display the indicated code. 	OFF	5 Flashes	OFF ON if call present; OFF if no call	<ul style="list-style-type: none"> Open Circuit 	<ul style="list-style-type: none"> Power is disconnected. Failed compressor protector. Compressor not properly wired to control. 	<ul style="list-style-type: none"> Check circuit breakers and fuses. Check wiring to unit; repair/replace as needed. Check compressor; repair/replace as needed. Check compressor wiring; repair/replace as needed. 	<ul style="list-style-type: none"> Turn power OFF prior to repair. Fault will clear after 1 normal cycle. Fault may be cleared by cycling 24VAC to control. Replace with correct replacement part(s).
<ul style="list-style-type: none"> Compressor and outdoor fan are off. Low pressure and high pressure switches are closed. Integrated control module diagnostic/status LED's display the indicated code. 	OFF	6 Flashes	OFF ON if call present; OFF if no call	<ul style="list-style-type: none"> Open Start Circuit 	<ul style="list-style-type: none"> Compressor start winding is open. Failed compressor run capacitor. Faulty run capacitor wiring. Compressor not properly wired to control. Faulty compressor wiring. 	<ul style="list-style-type: none"> Check compressor; repair/replace as needed. Check run capacitor; replace as needed. Check wiring; repair/replace as needed. 	<ul style="list-style-type: none"> Turn power OFF prior to repair. Fault will clear after 1 normal cycle. Fault may be cleared by cycling 24VAC to control. Replace with correct replacement part(s).
<ul style="list-style-type: none"> Compressor and outdoor fan are off. Low pressure and high pressure switches are closed. Open start circuit has been detected 4 times with 5 minute delay between each detection. Integrated control module diagnostic/status LED's display the indicated code. 	OFF	6 Flashes	ON ON if call present; OFF if no call	<ul style="list-style-type: none"> Open Start Circuit Lockout 	<ul style="list-style-type: none"> Compressor start winding is open. Failed compressor run capacitor. Faulty run capacitor wiring. Compressor not properly wired to control. Faulty compressor wiring. 	<ul style="list-style-type: none"> Check compressor; repair/replace as needed. Check run capacitor; replace as needed. Check wiring; repair/replace as needed. 	<ul style="list-style-type: none"> Turn power OFF prior to repair. Must clear fault by cycling 24VAC to control. Replace with correct replacement part(s).

Symptoms of Abnormal Operation	Diagnostic/Status LED Codes				Fault Description	Possible Causes	Corrective Actions	Notes & Cautions
	Green	Yellow	Red	Red Y1				
<ul style="list-style-type: none"> Compressor and outdoor fan are off. Low pressure and high pressure switches are closed. Integrated control module diagnostic/status LED's display the indicated code. 	OFF	7 Flashes	OFF	ON if call present; OFF if no call	<ul style="list-style-type: none"> Open Run Circuit 	<ul style="list-style-type: none"> Compressor run winding is open. Compressor not properly wired to control. Faulty compressor wiring. 	<ul style="list-style-type: none"> Check compressor; repair/replace as needed. Check wiring; repair/replace as needed. 	<ul style="list-style-type: none"> Turn power OFF prior to repair. Fault will clear after 1 normal cycle. Fault may be cleared by cycling 24VAC to control. Replace with correct replacement part(s).
<ul style="list-style-type: none"> Compressor and outdoor fan are off. Low pressure and high pressure switches are closed. Open run circuit has been detected 4 times with 5 minute delay between each detection. Integrated control module diagnostic/status LED's display the indicated code. 	OFF	7 Flashes	ON	ON if call present; OFF if no call	<ul style="list-style-type: none"> Open Run Circuit Lockout 	<ul style="list-style-type: none"> Compressor run winding is open. Compressor not properly wired to control. Faulty compressor wiring. 	<ul style="list-style-type: none"> Check compressor; repair/replace as needed. Check wiring; repair/replace as needed. 	<ul style="list-style-type: none"> Turn power OFF prior to repair. Must clear fault by cycling 24VAC to control. Replace with correct replacement part(s).
<ul style="list-style-type: none"> Air conditioner/heat pump may appear to be operating normally. Compressor protector may be open (compressor and outdoor fan off). Integrated control module diagnostic/status LED's display the indicated code. 	OFF	8 Flashes	OFF	ON if call present; OFF if no call	<ul style="list-style-type: none"> Low Line Voltage 	<ul style="list-style-type: none"> Low line voltage. 	<ul style="list-style-type: none"> Check circuit breakers and fuses. Verify unit is connected to power supply as specified on rating plate. Correct low line voltage condition; contact local utility if needed. 	<ul style="list-style-type: none"> Turn power OFF prior to repair. Control detects line voltage less than 185 VAC.
<ul style="list-style-type: none"> Air conditioner/heat pump may appear to be operating normally. Compressor protector may be open (compressor and outdoor fan off). Integrated control module diagnostic/status LED's display the indicated code. 	ON	8 Flashes	OFF	ON if call present; OFF if no call	<ul style="list-style-type: none"> High Line Voltage 	<ul style="list-style-type: none"> High line voltage. 	<ul style="list-style-type: none"> Correct high line voltage condition; contact local utility if needed. Verify unit is connected to power supply as specified on rating plate. Correct low line voltage condition; contact local utility if needed. 	<ul style="list-style-type: none"> Turn power OFF prior to repair. Control detects line voltage greater than 255 VAC.

Symptoms of Abnormal Operation	Diagnostic/Status LED Codes			Fault Description	Possible Causes	Corrective Actions	Notes & Cautions
	Green	Yellow	Red				
<ul style="list-style-type: none"> Air conditioner/heat pump may appear to be operating normally. Integrated control module diagnostic/status LED's display the indicated code. 	OFF	9 Flashes	OFF	<ul style="list-style-type: none"> Low Pilot Voltage 	<ul style="list-style-type: none"> Control detects secondary voltage less than 18 VAC. Transformer overloaded. Low line voltage. 	<ul style="list-style-type: none"> Check fuse. Correct low secondary voltage condition. Check transformer; replace if needed. 	<ul style="list-style-type: none"> Turn power OFF prior to repair. Fault will clear if secondary voltage rises above 21VAC. Replace with correct replacement part(s).
<ul style="list-style-type: none"> Compressor is off. Integrated control module diagnostic/status LED's display the indicated code. 	OFF	ON	ON	<ul style="list-style-type: none"> Comp Protector Open 	<ul style="list-style-type: none"> No current through run or start windings. Compressor run winding is open. Compressor not properly wired to control. Faulty compressor wiring. Failed compressor run capacitor. Faulty run capacitor wiring. 	<ul style="list-style-type: none"> Check compressor; repair/replace as needed. Check wiring; repair/replace as needed. Check run capacitor; replace as needed. 	<ul style="list-style-type: none"> Turn power OFF prior to repair. Fault will clear after 1 normal cycle. Fault may be cleared by cycling 24VAC to control. Replace with correct replacement part(s).

7 SEGMENT LED (DS2)	7 SEGMENT LED (DS1)	DESCRIPTION OF CONDITION
0	n	Standby
0	1	Low Pressure CO Trip
0	1	Low Side Fault
0	2	High Pressure CO Trip
0	2	High Side Fault
0	3	Short Cycling
0	4	Locked Rotor
0	5	Open Circuit
0	6	Open Start Circuit
0	7	Open Run Circuit
0	8	No Line Voltage
0	9	Low Pilot Voltage
8	8	Power Up
A	2	Outdoor Air Temp Sensor Fault
A	3	Outdoor Coil Temp Sensor Fault *
b	0	No Indoor Airflow
b	9	Inadequate Airflow
C	3	Cool Mode Short Cycle Timer
C	1	Low Cool
C	2	High Cool
d	F	Defrost *
d	t	Max Defrost Time *
d	E	Forced Defrost *
d	0	Data not yet on Network
d	1	Invalid Data on Network
d	2	System Mis-Match
d	3	Configuration Mis-Match
d	4	Invalid Shared Data
E	E	Board Misoperation
E	5	Open Fuse
F	t	Field Test Mode
H	8	High Line Voltage
L	1	LPCO Lockout (3 Trips)
L	2	HPCO Lockout (3 Trips)
L	6	Open Start Circuit Lockout
L	7	Open Run Circuit Lockout
L	8	Low Line Voltage
P	3	Heat Mode Short Cycle Timer *
P	1	Low Heat *
P	2	High Heat *
P	0	Comp Protector Open
P	d	Pump Down

* CODE USED ON HEAT PUMP MODELS ONLY

NOTE 1: DS1, DS2 AND DS3 ARE LABELED ON THE CONTROL ABOVE EACH 7 SEGMENT LED DISPLAY

NOTE 2: 7 SEGMENT LED DISPLAY DS3 IS NOT USED



0140M00407-A

SYSTEM TROUBLESHOOTING

UNITARY DIAGNOSTIC CODES							
Symptoms of Abnormal Operation	Diagnostic/Status LED Display Codes			Fault Description	Possible Causes	Corrective Actions	Notes & Cautions
	Digit 3	Digit 2	Digit 1				
<ul style="list-style-type: none"> Integrated control module diagnostic/status LED display shows the indicated code. 	BLANK	A	2	<ul style="list-style-type: none"> Outdoor air temp sensor fault 	<ul style="list-style-type: none"> Shorted sensor. Open sensor Sensor disconnected Sensor out of range 	<ul style="list-style-type: none"> Check sensor connection Replace open/shorted sensor 	<ul style="list-style-type: none"> Turn power OFF prior to repair. Replace with correct replacement part.
<ul style="list-style-type: none"> Heat pump fails to operate in heating mode. Integrated control module diagnostic/status LED display shows the indicated code 	BLANK	A	3	<ul style="list-style-type: none"> Outdoor coil temp sensor fault 	<ul style="list-style-type: none"> Shorted sensor. Open sensor Sensor disconnected Sensor out of range 	<ul style="list-style-type: none"> Check sensor connection Replace open/shorted sensor 	<ul style="list-style-type: none"> Turn power OFF prior to repair. Replace with correct replacement part.
<ul style="list-style-type: none"> Air conditioner/heat pump fails to operate Integrated control module diagnostic/status LED display shows the indicated code 	BLANK	E	5	<ul style="list-style-type: none"> Open fuse 	<ul style="list-style-type: none"> Short in low voltage wiring 	<ul style="list-style-type: none"> Locate and correct short in low voltage wiring 	<ul style="list-style-type: none"> Turn power OFF prior to repair Replace fuse with 3-amp automotive type
<ul style="list-style-type: none"> Air conditioner/heat pump fails to operate Integrated control module diagnostic/status LED display shows the indicated code 	BLANK	E	E	<ul style="list-style-type: none"> Board misoperation 	<ul style="list-style-type: none"> Compressor relay contacts welded 	<ul style="list-style-type: none"> Replace control 	<ul style="list-style-type: none"> Turn power OFF prior to repair Replace with correct replacement part
<ul style="list-style-type: none"> Air conditioner/heat pump fails to operate Integrated control module diagnostic/status LED display shows the indicated code 	BLANK	b	0	<ul style="list-style-type: none"> Circulator blower motor is not running when it should be running 	<ul style="list-style-type: none"> Indoor blower motor problem Communications error between indoor and outdoor unit 	<ul style="list-style-type: none"> Check indoor blower motor Check indoor blower motor wiring Check indoor unit control Repair/replace any faulty wiring Repair/replace indoor blower motor or control 	<ul style="list-style-type: none"> Turn power OFF prior to repair Replace with correct replacement part
<ul style="list-style-type: none"> Air conditioner/heat pump operates at reduced performance Air conditioner/heat pump operating at low stage when expected to operate at high stage Integrated control module diagnostic/status LED display shows the indicated code 	BLANK	b	9	<ul style="list-style-type: none"> Airflow is lower than demanded 	<ul style="list-style-type: none"> Indoor blower motor problem Blocked filters Restrictive/undersized ductwork Indoor/outdoor unit mismatch 	<ul style="list-style-type: none"> Check indoor blower motor Check filters; clean/replace as needed Check ductwork; resize as needed Verify indoor and outdoor units are properly matched 	<ul style="list-style-type: none"> Turn power OFF prior to repair Replace with correct replacement part. See specification sheet(s) for airflow requirements and maximum external static pressure See specification sheets for approved system matches

UNITARY DIAGNOSTIC CODES							
Symptoms of Abnormal Operation	Diagnostic/Status LED Display Codes			Fault Description	Possible Causes	Corrective Actions	Notes & Cautions
	Digit 3	Digit 2	Digit 1				
<ul style="list-style-type: none"> • Air conditioner/heat pump fails to operate • Integrated control module diagnostic/status LED display shows the indicated code 	BLANK	d	0	<ul style="list-style-type: none"> • Data not yet on Network 	<ul style="list-style-type: none"> • Air conditioner/heat pump is wired as part of a communicating system and integrated control module does not contain any shared data 	<ul style="list-style-type: none"> • Verify system type (communicating or legacy) • Populate shared data using Bluetooth® Shared Data Loader BTSDL01 • Wire system as legacy system 	<ul style="list-style-type: none"> • Turn power OFF prior to repair • Use Bluetooth® Shared Data Loader BTSDL01 for your specific model • Insert Bluetooth® Shared Data Loader BTSDL01 BEFORE turning power ON. Bluetooth® Shared Data Loader BTSDL01 may be removed after data is loaded. Turn power OFF before removing Bluetooth® Shared Data Loader BTSDL01
<ul style="list-style-type: none"> • Air conditioner/heat pump fails to operate • Integrated control module diagnostic/status LED display shows the indicated code 	BLANK	d	1	<ul style="list-style-type: none"> • Invalid Data on Network 	<ul style="list-style-type: none"> • Air conditioner/heat pump is wired as part of a communicating system and integrated control module contains invalid shared data or network data is invalid for the integrated control module. 	<ul style="list-style-type: none"> • Verify system type (communicating or legacy) • Populate correct shared data using Bluetooth® Shared Data Loader BTSDL01 • Wire system as legacy system 	<ul style="list-style-type: none"> • Turn power OFF prior to repair • Use Bluetooth® Shared Data Loader BTSDL01 for your specific model • Insert Bluetooth® Shared Data Loader BTSDL01 BEFORE turning power ON. Bluetooth® Shared Data Loader BTSDL01 may be removed after data is loaded. Turn power OFF before removing Bluetooth® Shared Data Loader BTSDL01
<ul style="list-style-type: none"> • Air conditioner/heat pump fails to operate • Air conditioner/heat pump operating at reduced performance • Air conditioner/heat pump operating at low stage when expected to operate at high stage • Integrated control module diagnostic/status LED display shows the indicated code 	BLANK	d	2	<ul style="list-style-type: none"> • System mismatch 	<ul style="list-style-type: none"> • Air conditioner/heat pump is wired as part of a communicating system and outdoor unit requires airflow greater than indoor unit's airflow capability • Shared data is incompatible with the system or missing parameters 	<ul style="list-style-type: none"> • Verify system type (communicating or legacy) • Verify shared data is correct for your specific model; re-populate data if required • Wire system as legacy system. 	<ul style="list-style-type: none"> • Turn power OFF prior to repair • Use Bluetooth® Shared Data Loader BTSDL01 for your specific model • Insert Bluetooth® Shared Data Loader BTSDL01 BEFORE turning power ON. Bluetooth® Shared Data Loader BTSDL01 may be removed after data is loaded. Turn power OFF before removing Bluetooth® Shared Data Loader BTSDL01

UNITARY DIAGNOSTIC CODES							
Symptoms of Abnormal Operation	Diagnostic/Status LED Display Codes			Fault Description	Possible Causes	Corrective Actions	Notes & Cautions
	Digit 3	Digit 2	Digit 1				
<ul style="list-style-type: none"> Air conditioner/heat pump fails to operate Integrated control module diagnostic/status LED display shows the indicated code 	BLANK	d	3	<ul style="list-style-type: none"> Configuration Mismatch 	<ul style="list-style-type: none"> Shared data sent to integrated control module does not match hardware configuration 	<ul style="list-style-type: none"> Verify system type (communicating or legacy) Verify shared data is correct for your specific model; re-populate data if required Wire system as legacy system 	<ul style="list-style-type: none"> Turn power OFF prior to repair Use Bluetooth® Shared Data Loader BTSDL01 Insert Bluetooth® Shared Data Loader BTSDL01 BEFORE turning power ON. Bluetooth® Shared Data Loader BTSDL01 may be removed after data is loaded. Turn power OFF before removing Bluetooth® Shared Data Loader BTSDL01
<ul style="list-style-type: none"> Air conditioner/heat pump fails to operate Integrated control module diagnostic/status LED display shows the indicated code 	BLANK	d	4	<ul style="list-style-type: none"> Invalid Shared Data 	<ul style="list-style-type: none"> Shared data on Bluetooth® Shared Data Loader BTSDL01 has been rejected 	<ul style="list-style-type: none"> Verify system type (communicating or legacy) Verify shared data is correct for your specific model; re-populate data if required Wire system as legacy system 	<ul style="list-style-type: none"> Turn power OFF prior to repair Use Bluetooth® Shared Data Loader BTSDL01 for your specific model Insert Bluetooth® Shared Data Loader BTSDL01 BEFORE turning power ON. Bluetooth® Shared Data Loader BTSDL01 may be removed after data is loaded. Turn power OFF before removing Bluetooth® Shared Data Loader BTSDL01 Error code will be cleared once data is loaded.
<ul style="list-style-type: none"> Very long run time Four consecutive compressor protector trips with average run time between trips greater than 3 hours Compressor operating at high speed and outdoor fan operating at low speed Integrated control module diagnostic/status LED display shows the indicated code 	BLANK	0	1	<ul style="list-style-type: none"> Low Side Fault 	<ul style="list-style-type: none"> Low refrigerant charge Restriction in liquid line Indoor blower motor failure Indoor thermostat set extremely low 	<ul style="list-style-type: none"> Verify refrigerant charge; adjust as needed Check for restricted liquid line; repair/replace as needed Check indoor blower motor; repair/replace as needed Check indoor thermostat setting 	<ul style="list-style-type: none"> Turn power OFF prior to repair Fault will clear after 30 consecutive normal cycles Fault may be cleared by cycling 24VAC to control Replace with correct replacement part(s)
<ul style="list-style-type: none"> Compressor and outdoor fan are off Thermostat demand is present Integrated control module diagnostic/status LED display shows the indicated code 	BLANK	0	1	<ul style="list-style-type: none"> Low Pressure Cut Out Trip 	<ul style="list-style-type: none"> Low refrigerant charge Restriction in liquid line Indoor blower motor failure Indoor thermostat set extremely low 	<ul style="list-style-type: none"> Verify refrigerant charge; adjust as needed Check for restricted liquid line; repair/replace as needed Check indoor blower motor; repair/replace as needed Check low pressure switch; repair/replace as needed Check indoor thermostat setting 	<ul style="list-style-type: none"> Turn power OFF prior to repair Replace with correct replacement part(s)

UNITARY DIAGNOSTIC CODES							
Symptoms of Abnormal Operation	Diagnostic/Status LED Display Codes			Fault Description	Possible Causes	Corrective Actions	Notes & Cautions
	Digit 3	Digit 2	Digit 1				
<ul style="list-style-type: none"> Compressor and outdoor fan are off Low pressure switch trip 3 times within same thermostat demand Thermostat demand is present Integrated control module diagnostic/status LED display shows the indicated code 	BLANK	L	1	<ul style="list-style-type: none"> Low Pressure Cut Out Lockout (3 Trips) 	<ul style="list-style-type: none"> Low refrigerant charge Restriction in liquid line Indoor blower motor failure Indoor thermostat set extremely low 	<ul style="list-style-type: none"> Verify refrigerant charge; adjust as needed Check for restricted liquid line; repair/replace as needed Check indoor blower motor; repair/replace as needed Check low pressure switch; repair/replace as needed Check indoor thermostat setting 	<ul style="list-style-type: none"> Turn power OFF prior to repair Must clear fault by cycling 24VAC to control Replace with correct replacement part(s)
<ul style="list-style-type: none"> Four consecutive compressor protector trips with average run time between trips greater than 1 minute and less than 15 minutes Low pressure and high pressure switches are closed Integrated control module diagnostic/status LED display shows the indicated code 	BLANK	0	2	<ul style="list-style-type: none"> High Side Fault 	<ul style="list-style-type: none"> Blocked condenser coil Outdoor fan not running 	<ul style="list-style-type: none"> Check and clean the condenser coil Check outdoor fan motor; repair/replace as needed Check outdoor fan motor wiring; repair/replace as needed Check outdoor fan motor capacitor; replace as needed 	<ul style="list-style-type: none"> Turn power OFF prior to repair Fault will clear after 4 consecutive normal cycles Fault may be cleared by cycling 24VAC to control Replace with correct replacement part(s)
<ul style="list-style-type: none"> Compressor and outdoor fan are off Thermostat demand is present Integrated control module diagnostic/status LED display shows the indicated code 	BLANK	0	2	<ul style="list-style-type: none"> High Pressure Cut Out Trip 	<ul style="list-style-type: none"> Blocked condenser coil Outdoor fan not running 	<ul style="list-style-type: none"> Check and clean condenser coil Check outdoor fan motor; repair/replace as needed Check outdoor fan motor wiring; repair/replace as needed Check outdoor fan motor capacitor; replace as needed 	<ul style="list-style-type: none"> Turn power OFF prior to repair Replace with correct replacement part(s)
<ul style="list-style-type: none"> Compressor and outdoor fan are off Low pressure switch trip 3 times within same thermostat demand Thermostat demand is present Integrated control module diagnostic/status LED display shows the indicated code 	BLANK	L	2	<ul style="list-style-type: none"> High Pressure Cut Out Lockout (3 Trips) 	<ul style="list-style-type: none"> Blocked condenser coil Outdoor fan not running 	<ul style="list-style-type: none"> Check and clean condenser coil Check outdoor fan motor; repair/replace as needed Check outdoor fan motor wiring; repair/replace as needed Check outdoor fan motor capacitor; replace as needed 	<ul style="list-style-type: none"> Turn power OFF prior to repair Must clear fault by cycling 24VAC to control Replace with correct replacement part(s)

UNITARY DIAGNOSTIC CODES							
Symptoms of Abnormal Operation	Diagnostic/Status LED Display Codes			Fault Description	Possible Causes	Corrective Actions	Notes & Cautions
	Digit 3	Digit 2	Digit 1				
<ul style="list-style-type: none"> • Run time for last 4 cycles is less than 3 minutes each. • Compressor protector has not tripped. Low pressure and high pressure switches are closed. • Integrated control module diagnostic/status LED display shows the indicated code. 	BLANK	0	3	<ul style="list-style-type: none"> • Short Cycling 	<ul style="list-style-type: none"> • Intermittent thermostat demand • Faulty compressor relay 	<ul style="list-style-type: none"> • Check thermostat and thermostat wiring; repair/replace as needed • Check compressor relay operation; replace control as needed 	<ul style="list-style-type: none"> • Turn power OFF prior to repair • Fault will clear after 4 consecutive normal cycles • Fault may be cleared by cycling 24VAC to control • Replace with correct replacement part(s) • Minimum compressor run time is changed from 30 seconds to 3 minutes
<ul style="list-style-type: none"> • Compressor and outdoor fan are off • Compressor protector trips four consecutive times • Average run time between trips is less than 15 seconds • Integrated control module diagnostic/status LED display shows the indicated code 	BLANK	0	4	<ul style="list-style-type: none"> • Locked Rotor 	<ul style="list-style-type: none"> • Compressor bearings are seized • Failed compressor run capacitor • Faulty run capacitor wiring • Low line voltage 	<ul style="list-style-type: none"> • Check compressor operation; repair/replace as needed • Check run capacitor; replace as needed • Check wiring; repair/replace as needed • Verify line voltage is within range on rating plate; control local utility is out of range 	<ul style="list-style-type: none"> • Turn power OFF prior to repair • Must clear fault by cycling 24VAC to control • Replace with correct replacement part(s)
<ul style="list-style-type: none"> • Compressor and outdoor fan are off for greater than 4 hours • Low pressure and high pressure switches are closed • Integrated control module diagnostic/status LED display shows the indicated code 	BLANK	0	5	<ul style="list-style-type: none"> • Open Circuit 	<ul style="list-style-type: none"> • Power is disconnected • Failed compressor protector • Compressor not properly wired to control 	<ul style="list-style-type: none"> • Check circuit breakers and fuses • Check wiring to unit; repair/replace as needed • Check compressor; repair/replace as needed • Check compressor wiring; repair/replace as needed 	<ul style="list-style-type: none"> • Turn power OFF prior to repair • Fault will clear after 1 normal cycle • Fault may be cleared by cycling 24VAC to control • Replace with correct replacement part(s)
<ul style="list-style-type: none"> • Compressor and outdoor fan are off • Low pressure and high pressure switches are closed • Integrated control module diagnostic/status LED display shows the indicated code 	BLANK	0	6	<ul style="list-style-type: none"> • Open Start Circuit 	<ul style="list-style-type: none"> • Compressor start winding is open • Failed compressor run capacitor • Faulty run capacitor wiring • Compressor not properly wired to control • Faulty compressor wiring 	<ul style="list-style-type: none"> • Check compressor; repair/replace as needed • Check run capacitor; replace as needed • Check wiring; repair/replace as needed 	<ul style="list-style-type: none"> • Turn power OFF prior to repair • Fault will clear after 1 normal cycle • Fault may be cleared by cycling 24VAC to control • Replace will correct replacement part(s)

UNITARY DIAGNOSTIC CODES							
Symptoms of Abnormal Operation	Diagnostic/Status LED Display Codes			Fault Description	Possible Causes	Corrective Actions	Notes & Cautions
	Digit 3	Digit 2	Digit 1				
<ul style="list-style-type: none"> Compressor and outdoor fan are off Low pressure and high pressure switches are closed Open start circuit has been detected 4 times with 5 minute delay between each detection Integrated control module diagnostic/status LED display shows the indicated code 	BLANK	L	6	<ul style="list-style-type: none"> Open Start Circuit Lockout 	<ul style="list-style-type: none"> Compressor start winding is open Failed compressor run capacitor Faulty run capacitor wiring Compressor not properly wired to control Faulty compressor wiring 	<ul style="list-style-type: none"> Check compressor; repair/replace as needed Check run capacitor; replace as needed Check wiring repair/replace as needed 	<ul style="list-style-type: none"> Turn power OFF prior to repair Must clear fault by cycling 24VAC to control Replace with correct replacement part(s)
<ul style="list-style-type: none"> Compressor and outdoor fan are off Low pressure and high pressure switches are closed Integrated control module diagnostic/status LED display shows the indicated code 	BLANK	0	7	<ul style="list-style-type: none"> Open Run Circuit 	<ul style="list-style-type: none"> Compressor run winding is open Compressor not properly wired to control Faulty compressor wiring 	<ul style="list-style-type: none"> Check compressor; repair/replace as needed Check wiring; repair/replace as needed 	<ul style="list-style-type: none"> Turn power OFF prior to repair Fault will clear after 1 normal cycle Fault may be cycling 24VAC to control Replace with correct replacement part(s)
<ul style="list-style-type: none"> Compressor and outdoor fan are off Low pressure and high pressure switches are closed Open run circuit has been detected 4 times with 5 minute delay between each detection Integrated control module diagnostic/status LED display shows the indicated code 	BLANK	L	7	<ul style="list-style-type: none"> Open Run Circuit Lockout 	<ul style="list-style-type: none"> Compressor run winding is open Compressor not properly wired to control Faulty compressor wiring 	<ul style="list-style-type: none"> Check compressor; repair/replace as needed Check wiring; repair/replace as needed 	<ul style="list-style-type: none"> Turn power OFF prior to repair Must clear fault by cycling 24VAC to control Replace with correct replacement part(s)
<ul style="list-style-type: none"> Air conditioner/heat pump may appear to be operating normally Compressor protector may be open (compressor and outdoor fan off) Integrated control module diagnostic/status LED display shows the indicated code 	BLANK	L	8	<ul style="list-style-type: none"> Low Line Voltage 	<ul style="list-style-type: none"> Low line voltage 	<ul style="list-style-type: none"> Check circuit breakers and fuses Verify unit is connected to power supply as specified on rating plate Correct low line voltage condition; contact local utility if needed 	<ul style="list-style-type: none"> Turn power OFF prior to repair Control detects line voltage less than 185 VAC Fault will clear if line voltage increases above 185 VAC

UNITARY DIAGNOSTIC CODES							
Symptoms of Abnormal Operation	Diagnostic/Status LED Display Codes			Fault Description	Possible Causes	Corrective Actions	Notes & Cautions
	Digit 3	Digit 2	Digit 1				
<ul style="list-style-type: none"> Air conditioner/heat pump may appear to be operating normally Compressor protector may be open (compressor and outdoor fan off) Integrated control module diagnostic/status LED display shows the indicated code 	BLANK	H	8	<ul style="list-style-type: none"> High Line Voltage 	<ul style="list-style-type: none"> High line voltage 	<ul style="list-style-type: none"> Correct high line voltage condition; contact local utility if needed Verify unit is connected to power supply as specified on rating plate 	<ul style="list-style-type: none"> Turn power OFF prior to repair Control detects line voltage greater than 255 VAC Fault will clear if line voltage decreases below 255 VAC
<ul style="list-style-type: none"> Air conditioner/heat pump may appear to be operating normally Integrated control module diagnostic/status LED display shows the indicated code 	BLANK	0	9	<ul style="list-style-type: none"> Low Pilot Voltage 	<ul style="list-style-type: none"> Control detects secondary voltage less than 18 VAC Transformer overloaded Low line voltage 	<ul style="list-style-type: none"> Check fuse Correct low secondary voltage condition Check transformer; replace if needed 	<ul style="list-style-type: none"> Turn power OFF prior to repair Fault will clear if secondary voltage rises above 21 VAC Replace with correct replacement part(s)
<ul style="list-style-type: none"> Compressor is off Integrated control module diagnostic/status LED display shows the indicated code 	BLANK	P	0	<ul style="list-style-type: none"> Comp Protector Open 	<ul style="list-style-type: none"> No current through run or start windings Compressor run winding is open Compressor not properly wired to control Faulty compressor wiring Failed compressor run capacitor Faulty run capacitor wiring 	<ul style="list-style-type: none"> Check compressor; repair/replace as needed Check wiring; repair/replace as needed Check run capacitor; replace as needed 	<ul style="list-style-type: none"> Turn power OFF prior to repair Fault will clear after 1 normal cycle Fault may be cleared by cycling 24VAC to control Replace with correct replacement part(s)
<ul style="list-style-type: none"> Air conditioner/ heat pump may appear to be operating normally Compressor protector may be open (compressor and outdoor fan off) Integrated control module diagnostic/status LED display shows the indicated code 	BLANK	0	8	<ul style="list-style-type: none"> No Line Voltage 	<ul style="list-style-type: none"> No line voltage 	<ul style="list-style-type: none"> Check circuit breaker and fuses Verify unit is connected to power supply as specified on rating plate 	<ul style="list-style-type: none"> Turn power OFF prior to repair Control detects line voltage less than 185VAC Fault will clear if line voltage increases above 185VAC

UNITARY DIAGNOSTIC CODES							
Symptoms of Abnormal Operation	Diagnostic/Status LED Display Codes			Fault Description	Possible Causes	Corrective Actions	Notes & Cautions
	Digit 3	Digit 2	Digit 1				
<ul style="list-style-type: none"> • Integrated control module diagnostic/status LED display shows the indicated code 	BLANK	A	2	<ul style="list-style-type: none"> • Outdoor air temp sensor fault 	<ul style="list-style-type: none"> • Shorted sensor • Open sensor • Sensor disconnected • Sensor out of range 	<ul style="list-style-type: none"> • Check sensor connection • Replace open/shorted sensor 	<ul style="list-style-type: none"> • Turn power OFF prior to repair • Replace with correct replacement part
<ul style="list-style-type: none"> • Heat pump fails to operate in heating mode • Integrated control module diagnostic/status LED display shows the indicated code 	BLANK	A	3	<ul style="list-style-type: none"> • Outdoor coil temp sensor fault 	<ul style="list-style-type: none"> • Shorted sensor • Open sensor • Sensor disconnected • Sensor out of range 	<ul style="list-style-type: none"> • Check sensor connection • Replace open/shorted sensor 	<ul style="list-style-type: none"> • Turn power OFF prior to repair • Replace with correct replacement part
<ul style="list-style-type: none"> • Air conditioner/heat pump fails to operate • Integrated control module diagnostic/status LED display shows the indicated code 	BLANK	E	5	<ul style="list-style-type: none"> • Open fuse 	<ul style="list-style-type: none"> • Short in low voltage wiring 	<ul style="list-style-type: none"> • Locate and correct short in low voltage wiring 	<ul style="list-style-type: none"> • Turn power OFF prior to repair • Replace fuse with 3-amp automotive type
<ul style="list-style-type: none"> • Air conditioner/heat pump fails to operate • Integrated control module diagnostic/status LED display shows the indicated code 	BLANK	E	E	<ul style="list-style-type: none"> • Board Misoperation 	<ul style="list-style-type: none"> • Compressor relay contacts welded 	<ul style="list-style-type: none"> • Replace control 	<ul style="list-style-type: none"> • Turn power OFF prior to repair • Replace with correct replacement part
<ul style="list-style-type: none"> • Air conditioner/heat pump fails to operate • Integrated control module diagnostic/status LED display shows the indicated code 	BLANK	b	0	<ul style="list-style-type: none"> • Circulator blower motor is not running when it should be running 	<ul style="list-style-type: none"> • Indoor blower motor problem • Communications error between indoor and outdoor unit 	<ul style="list-style-type: none"> • Check indoor blower motor • Check indoor blower motor wiring • Check indoor unit control • Repair/replace any faulty wiring • Repair/replace indoor blower motor or control 	<ul style="list-style-type: none"> • Turn power OFF prior to repair • Replace with correct replacement part
<ul style="list-style-type: none"> • Air conditioner/heat pump operates at reduced performance • Air conditioner/heat pump operating at low stage when expected to operate at high stage • Integrated control module diagnostic/status LED display shows the indicated code 	BLANK	b	9	<ul style="list-style-type: none"> • Airflow is lower than demanded 	<ul style="list-style-type: none"> • Indoor blower motor problem • Blocked filters • Restrictive/undersized ductwork • Indoor/outdoor unit mismatch 	<ul style="list-style-type: none"> • Check indoor blower motor • Check filters; clean/replace as needed • Check ductwork; resize as needed • Verify indoor and outdoor units are properly matched 	<ul style="list-style-type: none"> • Turn power OFF prior to repair • Replace with correct replacement part. See specification sheet(s) for airflow requirements and maximum external static pressure • See specification sheets for approved system matches

UNITARY DIAGNOSTIC CODES							
Symptoms of Abnormal Operation	Diagnostic/Status LED Display Codes			Fault Description	Possible Causes	Corrective Actions	Notes & Cautions
	Digit 3	Digit 2	Digit 1				
<ul style="list-style-type: none"> Air conditioner/heat pump fails to operate Integrated control module diagnostic/status LED display shows the indicated code 	BLANK	d	0	<ul style="list-style-type: none"> Data not yet on Network 	<ul style="list-style-type: none"> Air conditioner/heat pump is wired as part of a communicating system and integrated control module does not contain any shared data 	<ul style="list-style-type: none"> Verify system type (communicating or legacy) Populate shared data using Bluetooth® Shared Data Loader BTSDL01 Wire system as legacy system 	<ul style="list-style-type: none"> Turn power OFF prior to repair Use Bluetooth® Shared Data Loader BTSDL01 for your specific model Insert Bluetooth® Shared Data Loader BTSDL01 BEFORE turning power ON. Bluetooth® Shared Data Loader BTSDL01 may be removed after data is loaded. Turn power OFF before removing Bluetooth® Shared Data Loader BTSDL01
<ul style="list-style-type: none"> Air conditioner/heat pump fails to operate Integrated control module diagnostic/status LED display shows the indicated code 	BLANK	d	1	<ul style="list-style-type: none"> Invalid Data on Network 	<ul style="list-style-type: none"> Air conditioner/heat pump is wired as part of a communicating system and integrated control module contains invalid shared data or network data is invalid for the integrated control module 	<ul style="list-style-type: none"> Verify system type (communicating or legacy) Populate correct shared data using Bluetooth® Shared Data Loader BTSDL01 Wire system as legacy system 	<ul style="list-style-type: none"> Turn power OFF prior to repair Use Bluetooth® Shared Data Loader BTSDL01 for your specific model Insert Bluetooth® Shared Data Loader BTSDL01 BEFORE turning power ON. Bluetooth® Shared Data Loader BTSDL01 may be removed after data is loaded. Turn power OFF before removing Bluetooth® Shared Data Loader BTSDL01
<ul style="list-style-type: none"> Air conditioner/heat pump fails to operate Air conditioner/heat pump operating at reduced performance Air conditioner/heat pump operating at low stage when expected to operate at high stage Integrated control module diagnostic/status LED display shows the indicated code 	BLANK	d	2	<ul style="list-style-type: none"> System Mismatch 	<ul style="list-style-type: none"> Air conditioner/heat pump is wired as part of a communicating system and outdoor unit requires airflow greater than indoor unit's airflow capability Shared data is incompatible with the system or missing parameters 	<ul style="list-style-type: none"> Verify system type (communicating or legacy) Verify shared data is correct for your specific model; repopulate data if required Wire system as legacy system 	<ul style="list-style-type: none"> Turn power OFF prior to repair Use Bluetooth® Shared Data Loader BTSDL01 for your specific model Insert Bluetooth® Shared Data Loader BTSDL01 BEFORE turning power ON. Bluetooth® Shared Data Loader BTSDL01 may be removed after data is loaded. Turn power OFF before removing Bluetooth® Shared Data Loader BTSDL01 Error code will be cleared once data is loaded. Applies only to fully communicating system.

UNITARY DIAGNOSTIC CODES							
Symptoms of Abnormal Operation	Diagnostic/Status LED Display Codes			Fault Description	Possible Causes	Corrective Actions	Notes & Cautions
	Digit 3	Digit 2	Digit 1				
<ul style="list-style-type: none"> Air conditioner/heat pump fails to operate Integrated control module diagnostic/status LED display shows the indicated code 	BLANK	d	3	<ul style="list-style-type: none"> Configuration Mismatch 	<ul style="list-style-type: none"> Shared data sent to integrated control module does not match hardware configuration 	<ul style="list-style-type: none"> Verify system type (communicating or legacy) Verify shared data is correct for your specific model; repopulate data if required Wire system as legacy system 	<ul style="list-style-type: none"> Turn power OFF prior to repair Use Bluetooth® Shared Data Loader BTSDL01 for your specific model Insert Bluetooth® Shared Data Loader BTSDL01 BEFORE turning power ON. Bluetooth® Shared Data Loader BTSDL01 may be removed after data is loaded. Turn power OFF before removing Bluetooth® Shared Data Loader BTSDL01
<ul style="list-style-type: none"> Air conditioner/heat pump fails to operate Integrated control module diagnostic/status LED display shows the indicated code 	BLANK	d	4	<ul style="list-style-type: none"> Invalid Shared Data 	<ul style="list-style-type: none"> Shared data on Bluetooth® Shared Data Loader BTSDL01 has been rejected 	<ul style="list-style-type: none"> Verify system type (communicating or legacy) Verify shared data is correct for your specific model; repopulate data if required Wire system as legacy system 	<ul style="list-style-type: none"> Turn power OFF prior to repair Use Bluetooth® Shared Data Loader BTSDL01 for your specific model Insert Bluetooth® Shared Data Loader BTSDL01 BEFORE turning power ON. Bluetooth® Shared Data Loader BTSDL01 may be removed after data is loaded. Turn power OFF before removing Bluetooth® Shared Data Loader BTSDL01 Error code will be cleared once data is loaded.
<ul style="list-style-type: none"> Very long run time Four consecutive compressor protector trips with average run time between trips greater than 3 hours Compressor operating at high speed and outdoor fan operating at low speed Integrated control module diagnostic/status LED display shows the indicated code 	BLANK	0	1	<ul style="list-style-type: none"> Low Side Fault 	<ul style="list-style-type: none"> Low refrigerant charge Restriction in liquid line Indoor blower motor failure Indoor thermostat set extremely low 	<ul style="list-style-type: none"> Verify refrigerant charge; adjust as needed Check for restricted liquid line; repair/replace as needed Check indoor blower motor; repair/replace as needed Check indoor thermostat setting 	<ul style="list-style-type: none"> Turn power OFF prior to repair Fault will clear after 30 consecutive normal cycles Fault may be cleared by cycling 24VAC to control Replace with correct replacement part(s)
<ul style="list-style-type: none"> Compressor and outdoor fan are off Thermostat demand is present Integrated control module diagnostic/status LED display shows the indicated code 	BLANK	0	1	<ul style="list-style-type: none"> Low Pressure Cut Out Trip 	<ul style="list-style-type: none"> Low refrigerant charge Restriction in liquid line Indoor blower motor failure Indoor thermostat set extremely low 	<ul style="list-style-type: none"> Verify refrigerant charge; adjust as needed Check for restricted liquid line; repair/replace as needed Check indoor blower motor; repair/replace as needed Check low pressure switch; repair/replace as needed Check indoor thermostat setting 	<ul style="list-style-type: none"> Turn power OFF prior to repair Replace with correct replacement part(s)

UNITARY DIAGNOSTIC CODES							
Symptoms of Abnormal Operation	Diagnostic/Status LED Display Codes			Fault Description	Possible Causes	Corrective Actions	Notes & Cautions
	Digit 3	Digit 2	Digit 1				
<ul style="list-style-type: none"> Compressor and outdoor fan are off Low pressure switch trip 3 times within same thermostat demand Thermostat demand is present Integrated control module diagnostic/status LED display shows the indicated code 	BLANK	L	1	<ul style="list-style-type: none"> Low Pressure Cut Out Lockout (3 Trips) 	<ul style="list-style-type: none"> Low refrigerant charge Restriction in liquid line Indoor blower motor failure Indoor thermostat set extremely low 	<ul style="list-style-type: none"> Verify refrigerant charge; adjust as needed Check for restricted liquid line; repair/replace as needed Check indoor blower motor; repair/replace as needed Check low pressure switch; repair/replace as needed Check indoor thermostat setting 	<ul style="list-style-type: none"> Turn power OFF prior to repair Must clear fault by cycling 24VAC to control Replace with correct replacement part(s)
<ul style="list-style-type: none"> Four consecutive compressor protector trips with average run time between trips greater than 1 minute and less than 15 minutes Low pressure and high pressure switches are closed Integrated control module diagnostic/status LED display shows the indicated code 	BLANK	0	2	<ul style="list-style-type: none"> High Side Fault 	<ul style="list-style-type: none"> Blocked condenser coil Outdoor fan not running 	<ul style="list-style-type: none"> Check and clean the condenser coil Check outdoor fan motor; repair/replace as needed Check outdoor fan motor wiring; repair/replace as needed Check outdoor fan motor capacitor; replace as needed 	<ul style="list-style-type: none"> Turn power OFF prior to repair Fault will clear after 4 consecutive normal cycles Fault may be cleared by cycling 24VAC to control Replace with correct replacement part(s)
<ul style="list-style-type: none"> Compressor and outdoor fan are off Thermostat demand is present Integrated control module diagnostic/status LED display shows the indicated code 	BLANK	0	2	<ul style="list-style-type: none"> High Pressure Cut Out Trip 	<ul style="list-style-type: none"> Blocked condenser coil Outdoor fan not running 	<ul style="list-style-type: none"> Check and clean condenser coil Check outdoor fan motor; repair/replace as needed Check outdoor fan motor wiring; repair/replace as needed Check outdoor fan motor capacitor; replace as needed 	<ul style="list-style-type: none"> Turn power OFF prior to repair Replace with correct replacement part(s)
<ul style="list-style-type: none"> Compressor and outdoor fan are off Low pressure switch trip 3 times within same thermostat demand Thermostat demand is present Integrated control module diagnostic/status LED display shows the indicated code 	BLANK	L	2	<ul style="list-style-type: none"> High Pressure Cut Out Lockout (3 Trips) 	<ul style="list-style-type: none"> Blocked condenser coil Outdoor fan not running 	<ul style="list-style-type: none"> Check and clean condenser coil Check outdoor fan motor; repair/replace as needed Check outdoor fan motor wiring; repair/replace as needed Check outdoor fan motor capacitor; replace as needed 	<ul style="list-style-type: none"> Turn power OFF prior to repair Must clear fault by cycling 24VAC to control Replace with correct replacement part(s)

UNITARY DIAGNOSTIC CODES							
Symptoms of Abnormal Operation	Diagnostic/Status LED Display Codes			Fault Description	Possible Causes	Corrective Actions	Notes & Cautions
	Digit 3	Digit 2	Digit 1				
<ul style="list-style-type: none"> • Run time for last 4 cycles is less than 3 minutes each. • Compressor protector has not tripped. • Low pressure and high pressure switches are closed. • Integrated control module diagnostic/status LED display shows the indicated code. 	BLANK	0	3	<ul style="list-style-type: none"> • Short Cycling 	<ul style="list-style-type: none"> • Intermittent thermostat demand • Faulty compressor relay 	<ul style="list-style-type: none"> • Check thermostat and thermostat wiring; repair/replace as needed • Check compressor relay operation; replace control as needed 	<ul style="list-style-type: none"> • Turn power OFF prior to repair • Fault will clear after 4 consecutive normal cycles • Fault may be cleared by cycling 24VAC to control • Replace with correct replacement part(s) • Minimum compressor run time is changed from 30 seconds to 3 minutes
<ul style="list-style-type: none"> • Compressor and outdoor fan are off • Compressor protector trips four consecutive times • Average run time between trips is less than 15 seconds • Integrated control module diagnostic/status LED display shows the indicated code 	BLANK	0	4	<ul style="list-style-type: none"> • Locked Rotor 	<ul style="list-style-type: none"> • Compressor bearings are seized • Failed compressor run capacitor • Faulty run capacitor wiring • Low line voltage 	<ul style="list-style-type: none"> • Check compressor operation; repair/replace as needed • Check run capacitor; replace as needed • Check wiring; repair/replace as needed • Verify line voltage is within range on rating plate; control local utility is out of range 	<ul style="list-style-type: none"> • Turn power OFF prior to repair • Must clear fault by cycling 24VAC to control • Replace with correct replacement part(s)
<ul style="list-style-type: none"> • Compressor and outdoor fan are off for greater than 4 hours • Low pressure and high pressure switches are closed • Integrated control module diagnostic/status LED display shows the indicated code 	BLANK	0	5	<ul style="list-style-type: none"> • Open Circuit 	<ul style="list-style-type: none"> • Power is disconnected • Failed compressor protector • Compressor not properly wired to control 	<ul style="list-style-type: none"> • Check circuit breakers and fuses • Check wiring to unit; repair/replace as needed • Check compressor; repair/replace as needed • Check compressor wiring; repair/replace as needed 	<ul style="list-style-type: none"> • Turn power OFF prior to repair • Fault will clear after 1 normal cycle • Fault may be cleared by cycling 24VAC to control • Replace with correct replacement part(s)
<ul style="list-style-type: none"> • Compressor and outdoor fan are off • Low pressure and high pressure switches are closed • Integrated control module diagnostic/status LED display shows the indicated code 	BLANK	0	6	<ul style="list-style-type: none"> • Open Start Circuit 	<ul style="list-style-type: none"> • Compressor start winding is open • Failed compressor run capacitor • Faulty run capacitor wiring • Compressor not properly wired to control • Faulty compressor wiring 	<ul style="list-style-type: none"> • Check compressor; repair/replace as needed • Check run capacitor; replace as needed • Check wiring; repair/replace as needed 	<ul style="list-style-type: none"> • Turn power OFF prior to repair • Fault will clear after 1 normal cycle • Fault may be cleared by cycling 24VAC to control • Replace will correct replacement part(s)

UNITARY DIAGNOSTIC CODES							
Symptoms of Abnormal Operation	Diagnostic/Status LED Display Codes			Fault Description	Possible Causes	Corrective Actions	Notes & Cautions
	Digit 3	Digit 2	Digit 1				
<ul style="list-style-type: none"> Compressor and outdoor fan are off Low pressure and high pressure switches are closed Open start circuit has been detected 4 times with 5 minute delay between each detection Integrated control module diagnostic/status LED display shows the indicated code 	BLANK	L	6	<ul style="list-style-type: none"> Open Start Circuit Lockout 	<ul style="list-style-type: none"> Compressor start winding is open Failed compressor run capacitor Faulty run capacitor wiring Compressor not properly wired to control Faulty compressor wiring 	<ul style="list-style-type: none"> Check compressor; repair/replace as needed Check run capacitor; replace as needed Check wiring repair/replace as needed 	<ul style="list-style-type: none"> Turn power OFF prior to repair Must clear fault by cycling 24VAC to control Replace with correct replacement part(s)
<ul style="list-style-type: none"> Compressor and outdoor fan are off Low pressure and high pressure switches are closed Integrated control module diagnostic/status LED display shows the indicated code 	BLANK	0	7	<ul style="list-style-type: none"> Open Run Circuit 	<ul style="list-style-type: none"> Compressor run winding is open Compressor not properly wired to control Faulty compressor wiring 	<ul style="list-style-type: none"> Check compressor; repair/replace as needed Check wiring; repair/replace as needed 	<ul style="list-style-type: none"> Turn power OFF prior to repair Fault will clear after 1 normal cycle Fault may be cycling 24VAC to control Replace with correct replacement part(s)
<ul style="list-style-type: none"> Compressor and outdoor fan are off Low pressure and high pressure switches are closed Open run circuit has been detected 4 times with 5 minute delay between each detection Integrated control module diagnostic/status LED display shows the indicated code 	BLANK	L	7	<ul style="list-style-type: none"> Open Run Circuit Lockout 	<ul style="list-style-type: none"> Compressor run winding is open Compressor not properly wired to control Faulty compressor wiring 	<ul style="list-style-type: none"> Check compressor; repair/replace as needed Check wiring; repair/replace as needed 	<ul style="list-style-type: none"> Turn power OFF prior to repair Must clear fault by cycling 24VAC to control Replace with correct replacement part(s)
<ul style="list-style-type: none"> Air conditioner/heat pump may appear to be operating normally Compressor protector may be open (compressor and outdoor fan off) Integrated control module diagnostic/status LED display shows the indicated code 	BLANK	L	8	<ul style="list-style-type: none"> Low Line Voltage 	<ul style="list-style-type: none"> Low line voltage 	<ul style="list-style-type: none"> Check circuit breakers and fuses Verify unit is connected to power supply as specified on rating plate Correct low line voltage condition; contact local utility if needed 	<ul style="list-style-type: none"> Turn power OFF prior to repair Control detects line voltage less than 185 VAC Fault will clear if line voltage increases above 185 VAC

UNITARY DIAGNOSTIC CODES							
Symptoms of Abnormal Operation	Diagnostic/Status LED Display Codes			Fault Description	Possible Causes	Corrective Actions	Notes & Cautions
	Digit 3	Digit 2	Digit 1				
<ul style="list-style-type: none"> Air conditioner/heat pump may appear to be operating normally Compressor protector may be open (compressor and outdoor fan off) Integrated control module diagnostic/status LED display shows the indicated code 	BLANK	H	8	<ul style="list-style-type: none"> High Line Voltage 	<ul style="list-style-type: none"> High line voltage 	<ul style="list-style-type: none"> Correct high line voltage condition; contact local utility if needed Verify unit is connected to power supply as specified on rating plate 	<ul style="list-style-type: none"> Turn power OFF prior to repair Control detects line voltage greater than 255 VAC Fault will clear if line voltage decreases below 255 VAC
<ul style="list-style-type: none"> Air conditioner/heat pump may appear to be operating normally Integrated control module diagnostic/status LED display shows the indicated code 	BLANK	0	9	<ul style="list-style-type: none"> Low Pilot Voltage 	<ul style="list-style-type: none"> Control detects secondary voltage less than 18 VAC Transformer overloaded Low line voltage 	<ul style="list-style-type: none"> Check fuse Correct low secondary voltage condition Check transformer; replace if needed 	<ul style="list-style-type: none"> Turn power OFF prior to repair Fault will clear if secondary voltage rises above 21 VAC Replace with correct replacement part(s)
<ul style="list-style-type: none"> Compressor is off Integrated control module diagnostic/status LED display shows the indicated code 	BLANK	P	0	<ul style="list-style-type: none"> Comp Protector Open 	<ul style="list-style-type: none"> No current through run or start windings Compressor run winding is open Compressor not properly wired to control Faulty compressor wiring Failed compressor run capacitor Faulty run capacitor wiring 	<ul style="list-style-type: none"> Check compressor; repair/replace as needed Check wiring; repair/replace as needed Check run capacitor; replace as needed 	<ul style="list-style-type: none"> Turn power OFF prior to repair Fault will clear after 1 normal cycle Fault may be cleared by cycling 24VAC to control Replace with correct replacement part(s)
<ul style="list-style-type: none"> Air conditioner/ heat pump may appear to be operating normally Compressor protector may be open (compressor and outdoor fan off) Integrated control module diagnostic/status LED display shows the indicated code 	BLANK	0	8	<ul style="list-style-type: none"> No Line Voltage 	<ul style="list-style-type: none"> No line voltage 	<ul style="list-style-type: none"> Check circuit breaker and fuses Verify unit is connected to power supply as specified on rating plate 	<ul style="list-style-type: none"> Turn power OFF prior to repair Control detects line voltage less than 185VAC Fault will clear if line voltage increases above 185VAC

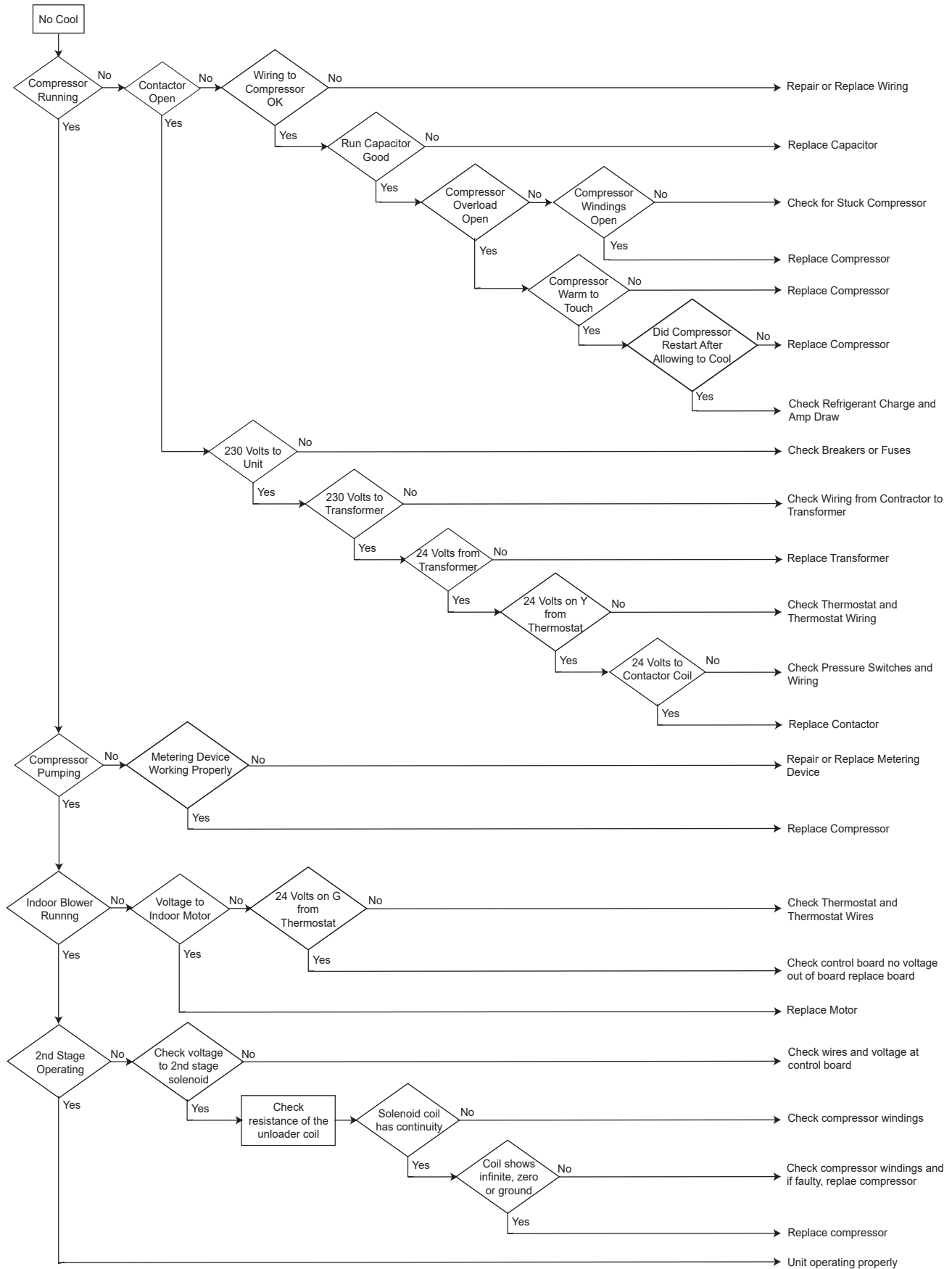

TROUBLESHOOTING

HEAT PUMP - NO COOL

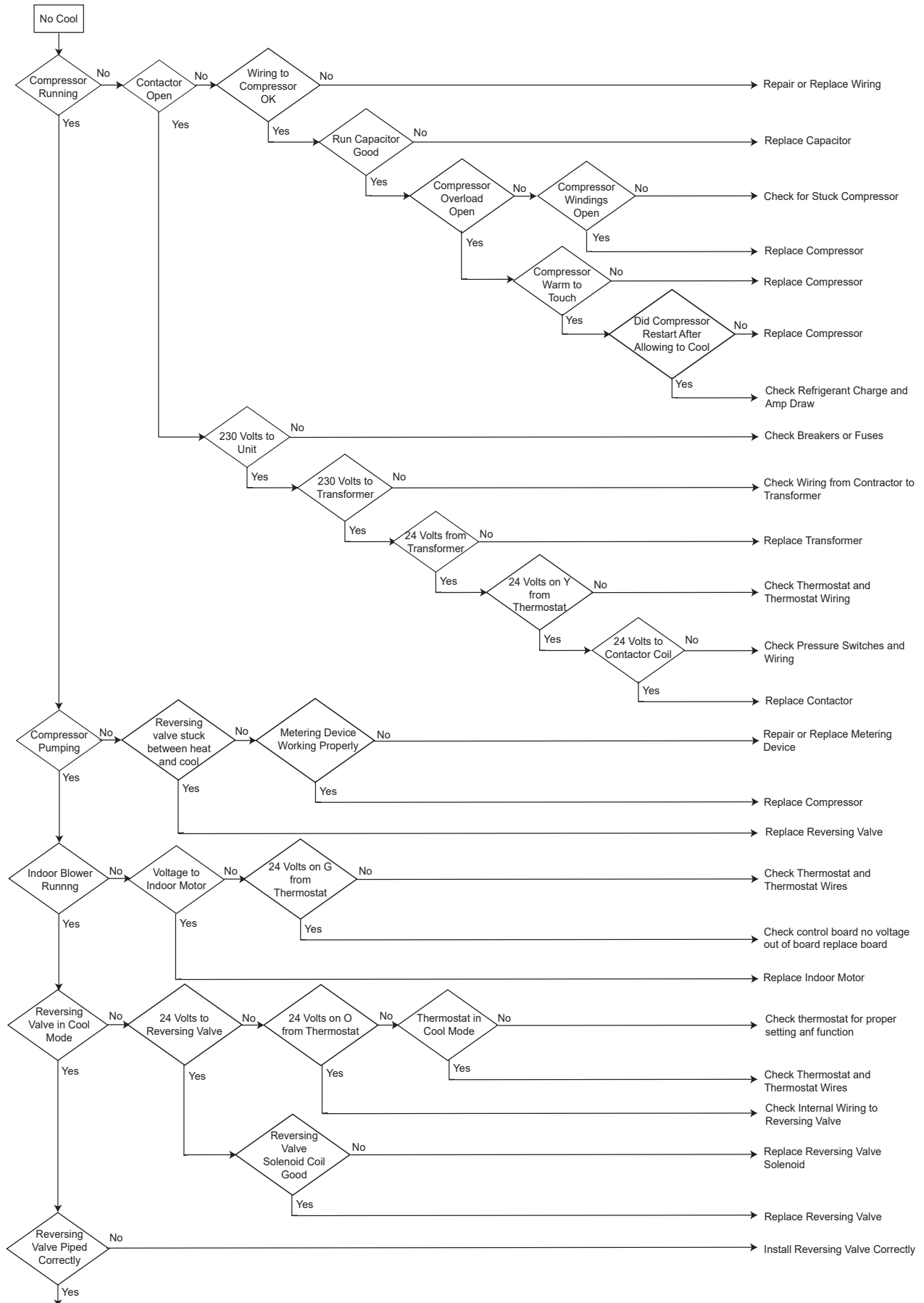

TROUBLESHOOTING

HEAT PUMP - NO COOL

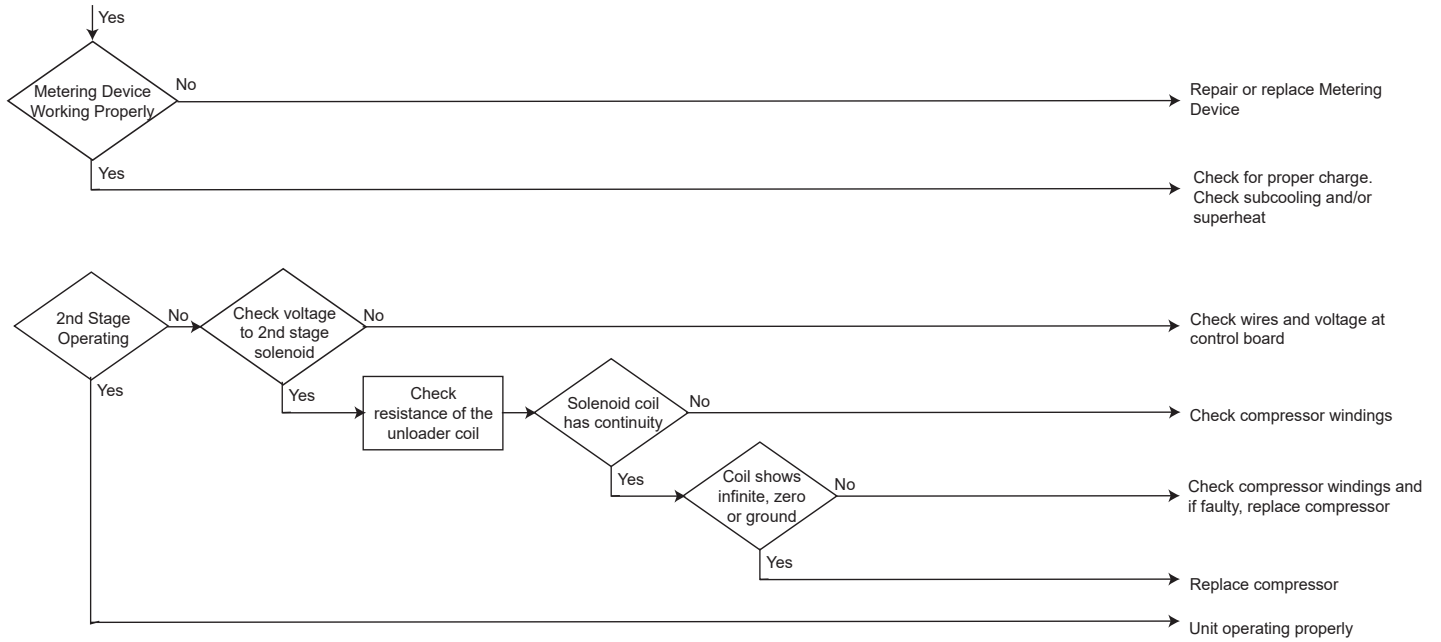

TROUBLESHOOTING

ERROR CODE - 01, L1

Error Code:
01, L1 - Low pressure cutout

Applicable Models:
Outdoor units

Method of Error Detection:
Integrated control module LED display provides the indicated error code

Error Decision Conditions:
Compressor and outdoor fan are off. Low pressure switch trip 3 times within same thermostat demand. Thermostat demand is present. Integrated control module diagnostic/ status LED display shows the indicated code

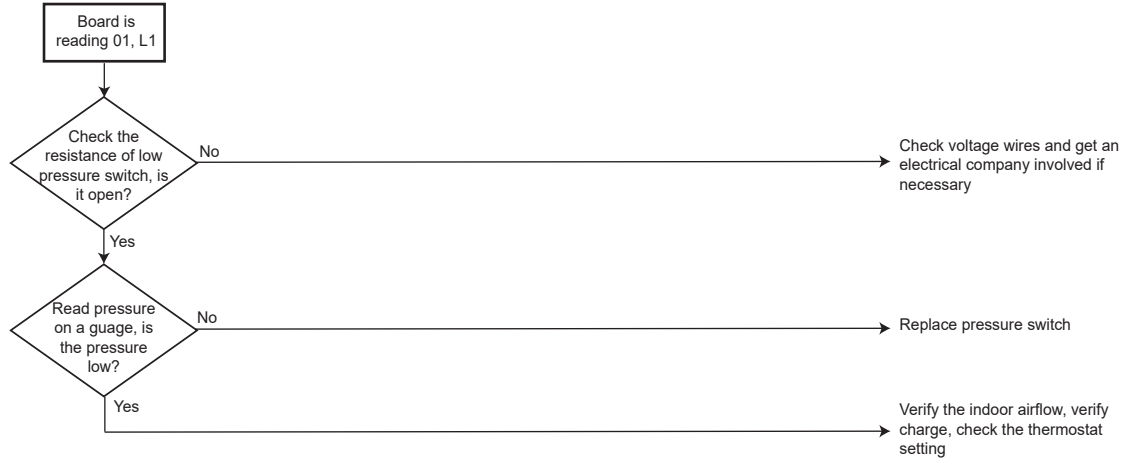

TROUBLESHOOTING

ERROR CODE - 02, L2

Error Code:
02, L2 - High side fault

Applicable Models:
Outdoor units

Method of Error Detection:
Integrated control module LED display provides the indicated error code

Error Decision Conditions:
Four consecutive compressor protector trips with average run time between trips greater than 1 minute and less than 15 minutes. Low pressure and high pressure switches are closed. Integrated control module diagnostic/ status LED display shows the indicated code

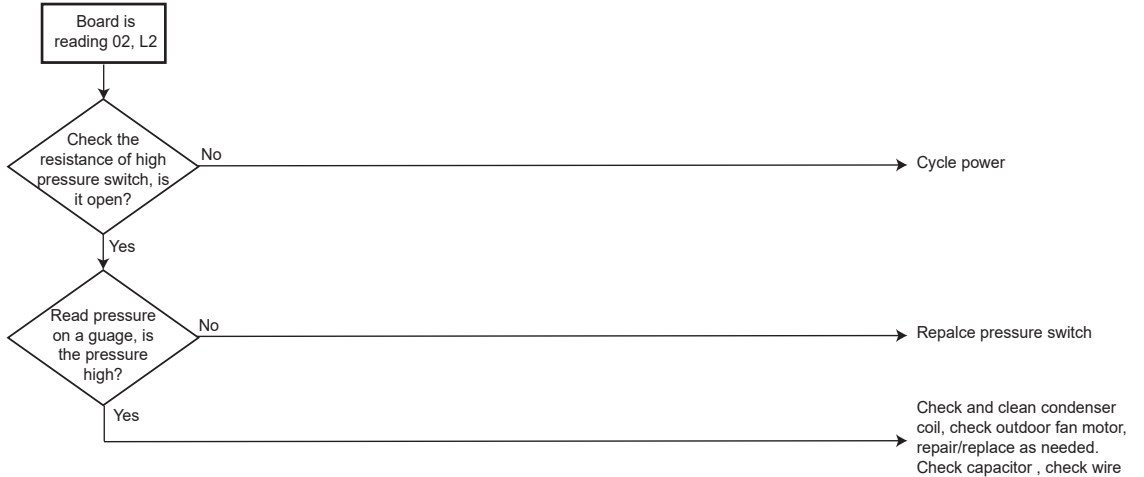

Error Code:
03 - Short cycling

Applicable Models:
Outdoor units

Method of Error Detection:
Integrated control module LED display provides the indicated error code

Error Decision Conditions:
Check thermostat and thermostat wiring; repair/ replace as needed. Check compressor relay operation; replace control as needed

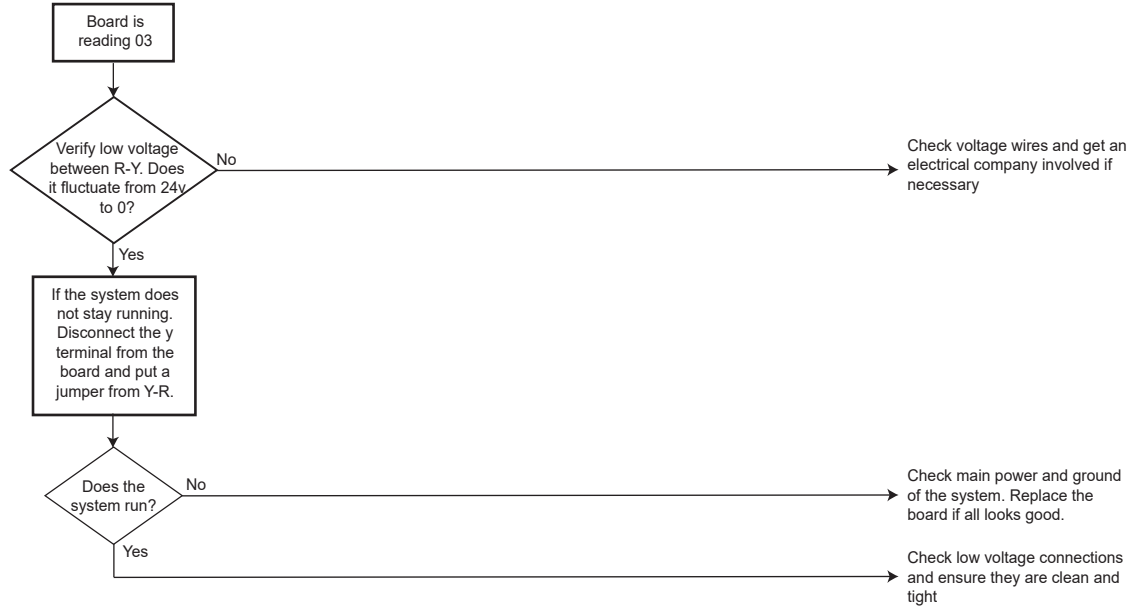

Error Code:
04 - Locked rotor

Applicable Models:
Outdoor units

Method of Error Detection:
Integrated control module LED display provides the indicated error code

Error Decision Conditions:
Check compressor operation; repair/ replace as needed. Check run capacitor; replace as needed. Check wiring; repair/replace as needed. Verify line voltage is within range on rating plate; control local utility is out of range

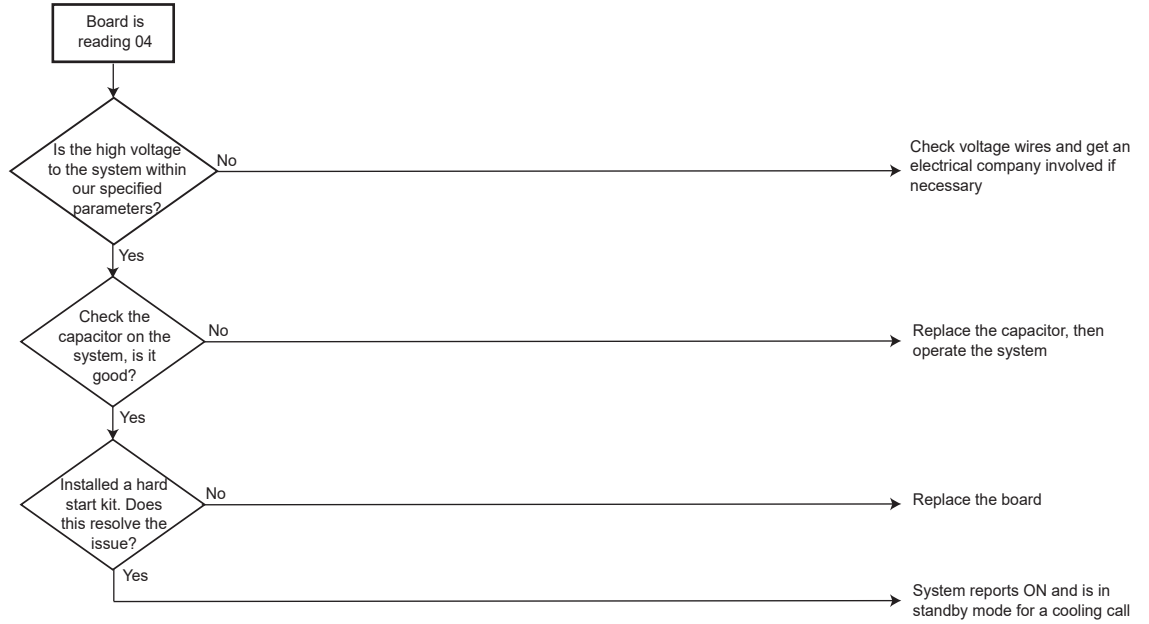

TROUBLESHOOTING

ERROR CODE - B0 & B1

Error Code:
 B0 - Blower motor not running
 B1 - Blower motor communication error

Applicable Models:
 DV**REC
 DV**PEC

Method of Error Detection:
 B0 - Number of revolutions of the blower motor
 B1 - Motor communication status

Error Decision Conditions:
 B0 - When feedback rpm < 50 is detected for 5 times or when checked feedback rpm < 50 reached 100 times. (When checked feedback rpm reaches 720 times.)
 B1 - When the communication from the motor can not be received correctly 5 seconds in a continuous.

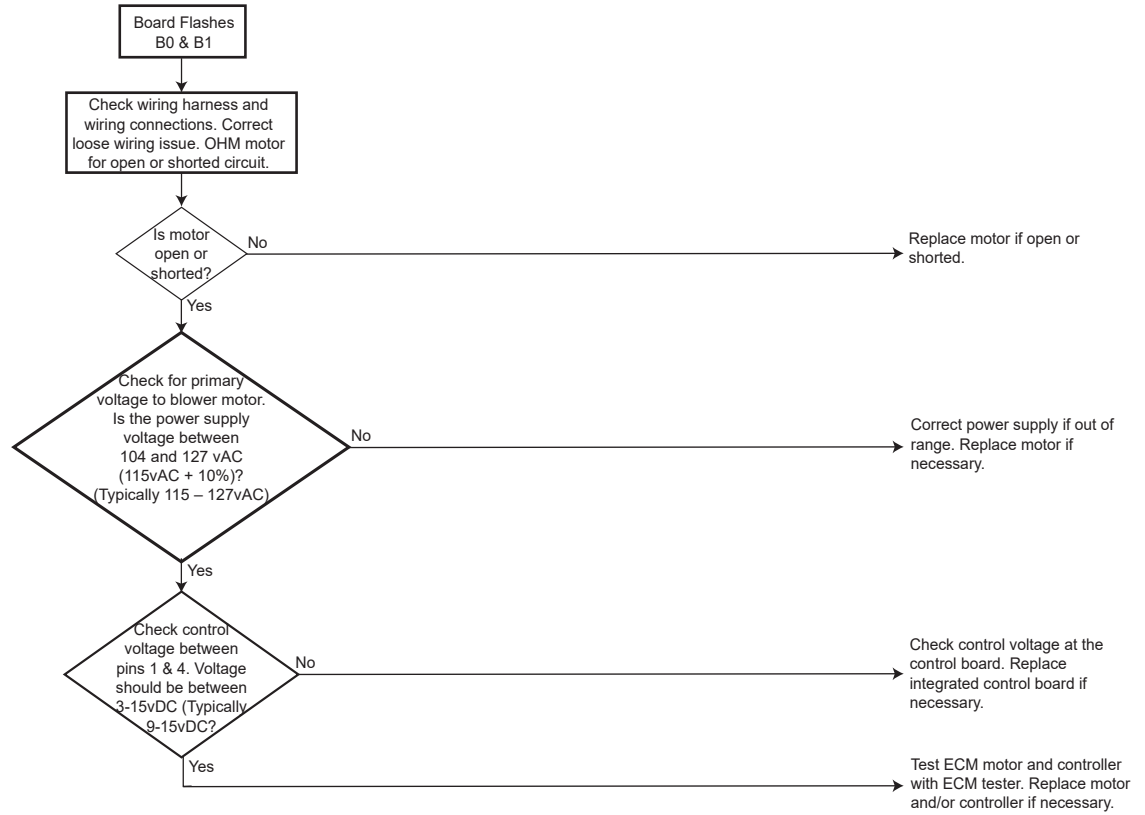

TROUBLESHOOTING

ERROR CODE - B2-B6, B9

Error Code:
 B2 - Blower motor operating in power, temp or speed limiting conditions
 B3 - Circulating blower motor is operating in a power, temperature, or speed limiting condition
 B4 - Blower motor- Current trip (or) lost rotor
 B5 - Circulator blower motor fails to start 10 consecutive times
 B6 - Circulator blower motor shuts down for over or under voltage condition. Circulator blower motor shuts down due to over temperature condition on power module
 B9 - Low indoor airflow (with electric heat mode)

Applicable Models:
 Indoor equipment

Method of Error Detection:
 B2 - According to the control status flags of the motor
 B3 - Air handler operates at reduced performance. Airflow delivered is less than expected
 B4 - According to the control status flags of the motor
 B5 - No air handler operation
 B6 - No air handler operation
 B9 - Number of revolutions of the blower motor

Error Decision Conditions:
 B2 - When the motor sets Control Status Flags (bit3, bit4 or bit9) (*).
 bit3=Power limit
 bit4=Temp limit
 bit9=Over temp
 B3 - When the motor sets Control Status Flags (bit3, bit4 or bit9) (*).
 bit3=Power limit
 bit4=Temp limit
 bit9=Over temp
 B4 - When the motor sets Control Status Flags (bit5=1 or bit6=1) (*).
 bit5=Lost Rotor trip
 bit6=Current trip
 B5 - When the motor is locked up and the demand for operation has been presented 10 times with no operation
 B6 - High/low voltage is detected in the controller.
 B9 - When EH demand is active and the above conditions.
 • When *50rpm<Feedback rpm*<Minrpm(150rpm) * is detected for 10 times consecutively
 Or
 • When feedback from motor's rpm is 50rpm > and Min rpm (150rpm) and it happens 360 times.
 (When checked rpm reaches 720 times.)

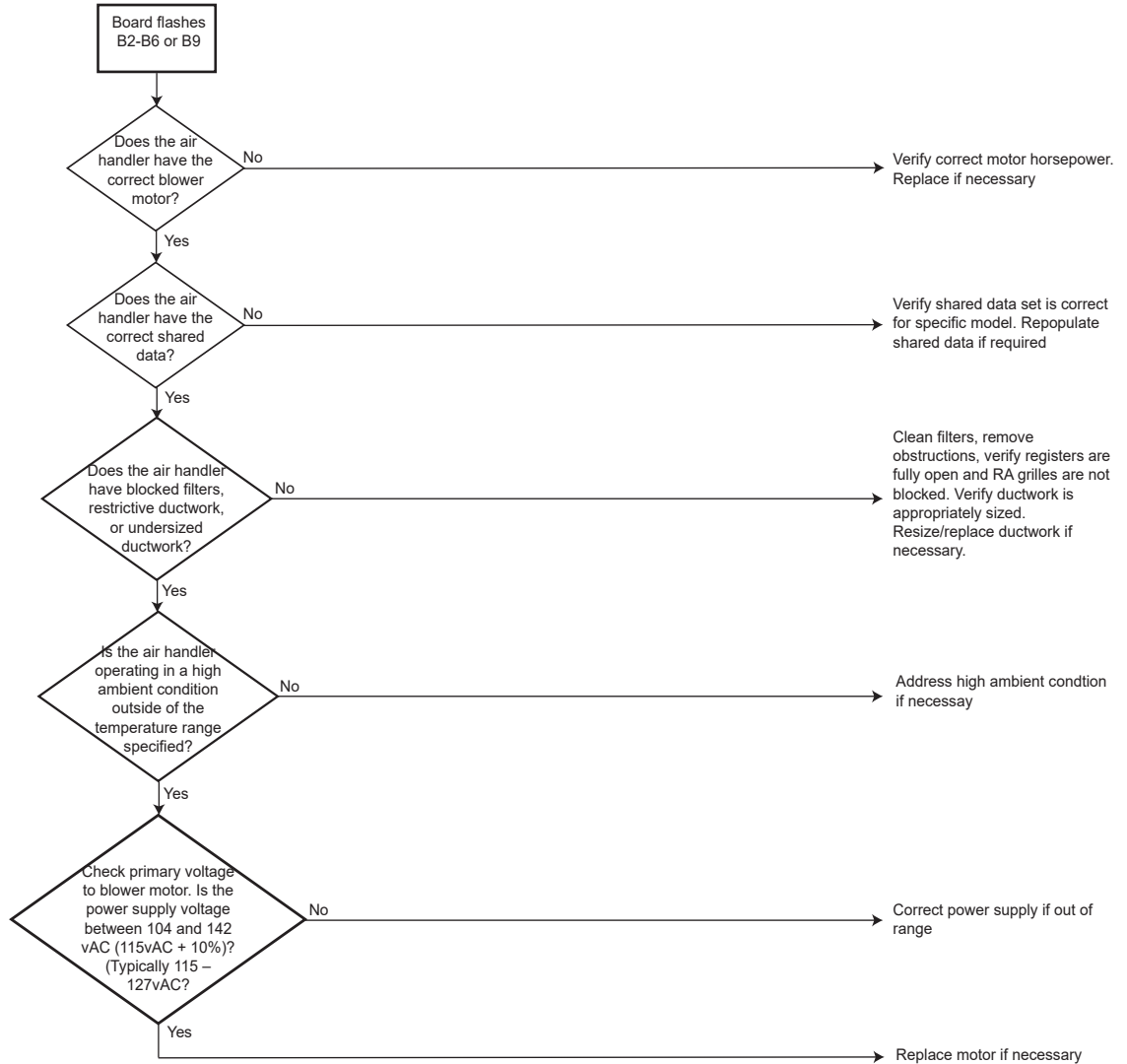

TROUBLESHOOTING

ERROR CODE - D0, D1, D4

Error Code:
D0 - Data not yet on network (No net data)
D1 - Invalid data on network (Invalid data)
D4 - Invalid bluetooth shared data loader BTSDL01 data (Invalid MC data)

Applicable Models:
Indoor / outdoor equipment

Method of Error Detection:
Shown on the system display

Error Decision Conditions:
Air conditioner/heat pump fails to operate. Integrated control module diagnostic/ status LED display shows the indicated code

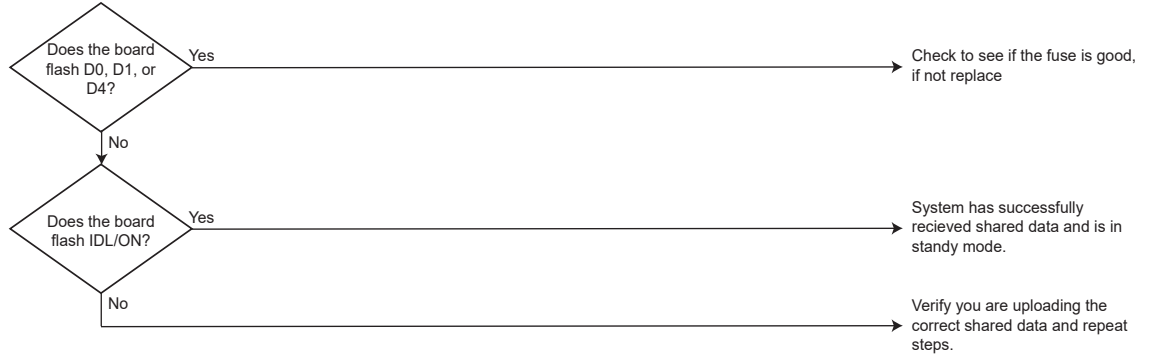

TROUBLESHOOTING

ERROR CODE - d2

Error Code:
d2 - System mismatch

Applicable Models:
Outdoor AC
Outdoor HP

Method of Error Detection:
Communication data from indoor unit

Error Decision Conditions:
When required CFM exceeds maximum CFM limit of the indoor unit. When a connected indoor unit is not EEV type.

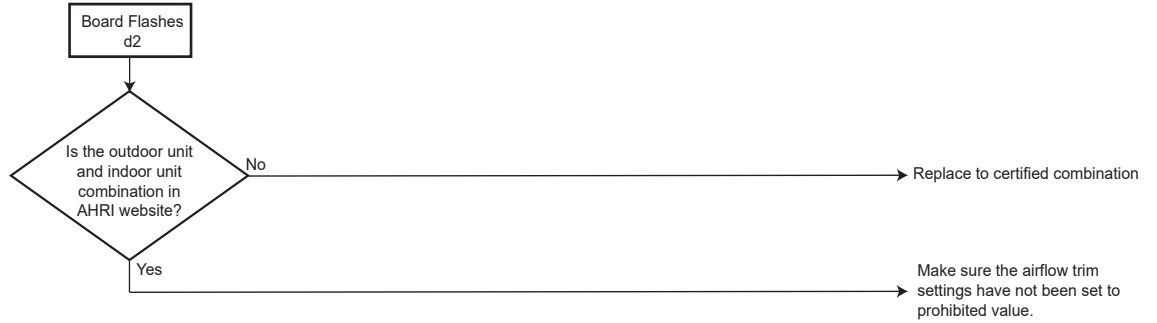

TROUBLESHOOTING

ERROR CODE - E5

Error Code:
E5 - Open Fuse

Applicable Models:
Outdoor units
Indoor units

Method of Error Detection:
Integrated control module LED display provides the indicated error code

Error Decision Conditions:
Blown fuse

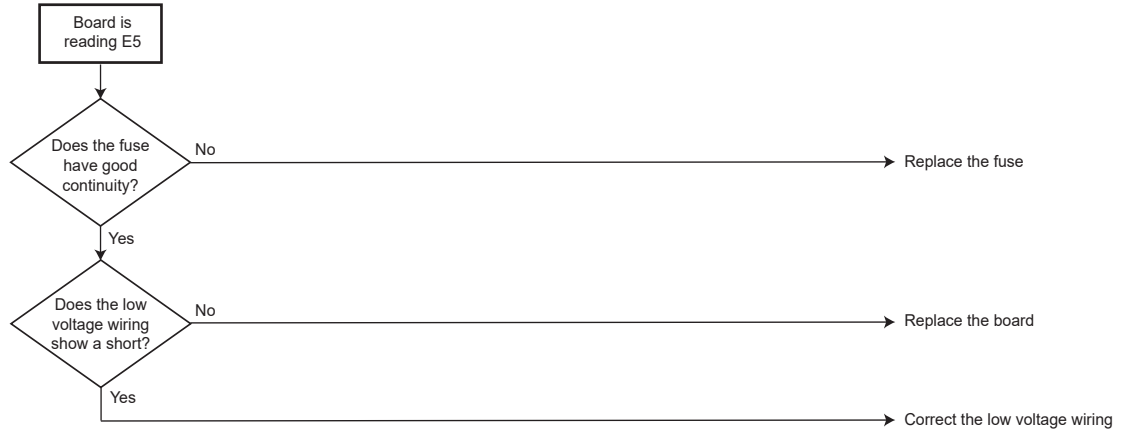

TROUBLESHOOTING

ERROR CODE - EC

Error Code:
EC - Heater too large / Heater too small / No heater match

Applicable Models:
Indoor units

Method of Error Detection:
Integrated control module LED display provides the indicated error

Error Decision Conditions:
Electric heaters fail to energize on a call for W1 or Auxiliary Emergency heat. Electric heat airflow is higher than expected on a call for W1 or Auxiliary Emergency heat.

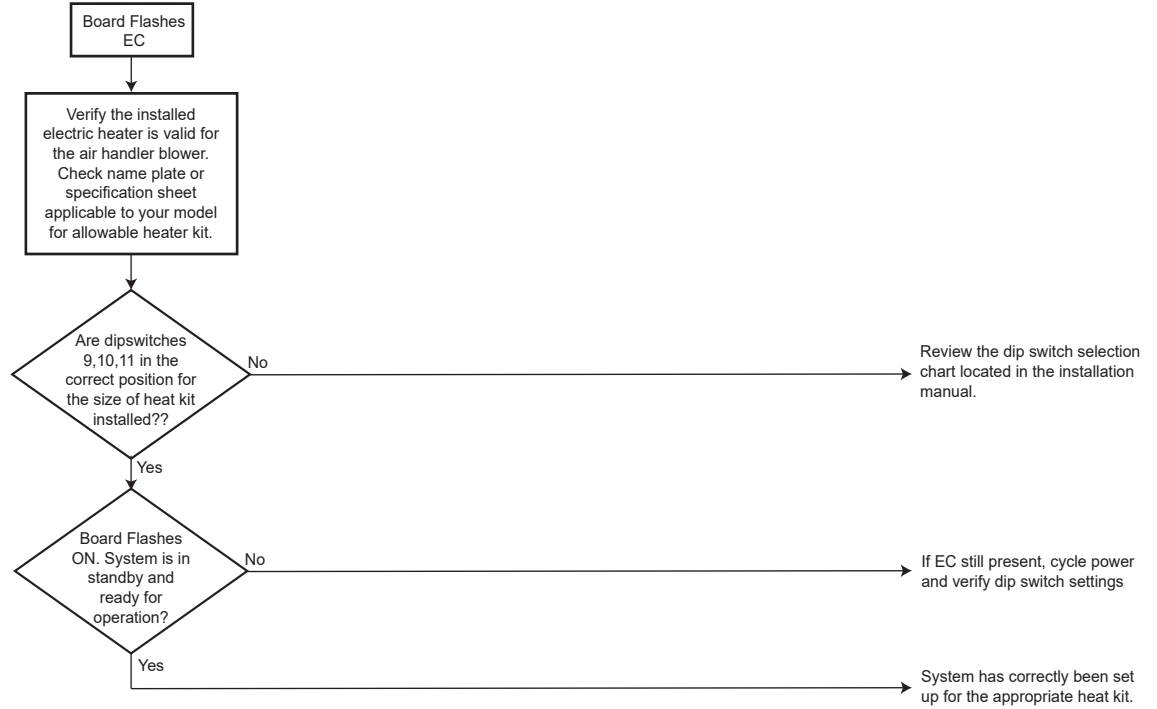

TROUBLESHOOTING

ERROR CODE - EE

Error Code:
EE - Board misoperation

Applicable Models:
Outdoor units

Method of Error Detection:
Integrated control module LED display provides the indicated error code

Error Decision Conditions:
Compressor relay contacts welded

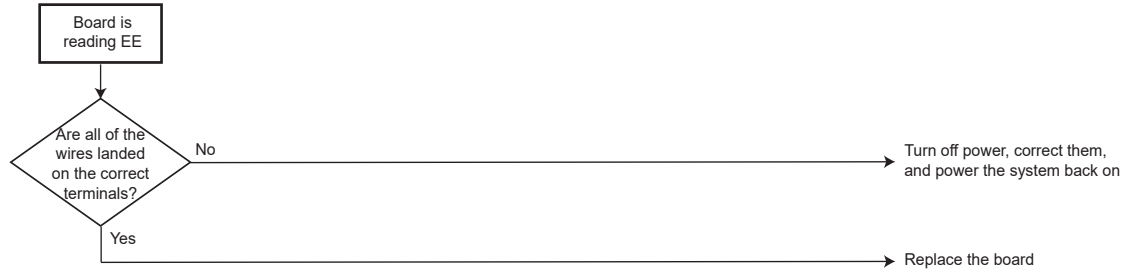

TROUBLESHOOTING

ERROR CODE - H8

Error Code:
H8 - High line voltage

Applicable Models:
Outdoor units

Method of Error Detection:
Integrated control module LED display provides the indicated error code

Error Decision Conditions:
Air conditioner/heat pump may appear to be operating normally. Compressor protector may be open (compressor and outdoor fan off). Integrated control module diagnostic/ status LED display shows the indicated code

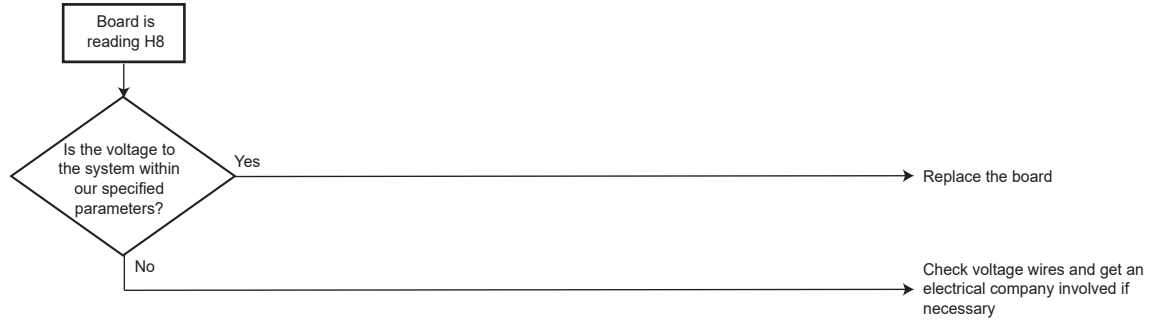

TROUBLESHOOTING

ERROR CODE - L8

Error Code:
L8 - Low line voltage

Applicable Models:
Outdoor units

Method of Error Detection:
Integrated control module LED display provides the indicated error code

Error Decision Conditions:
Check circuit breakers and fuses.
Verify unit is connected to power supply as specified on rating plate.
Correct low line voltage condition; contact local utility if needed



WIRING DIAGRAMS

3-Phase Heat Kit

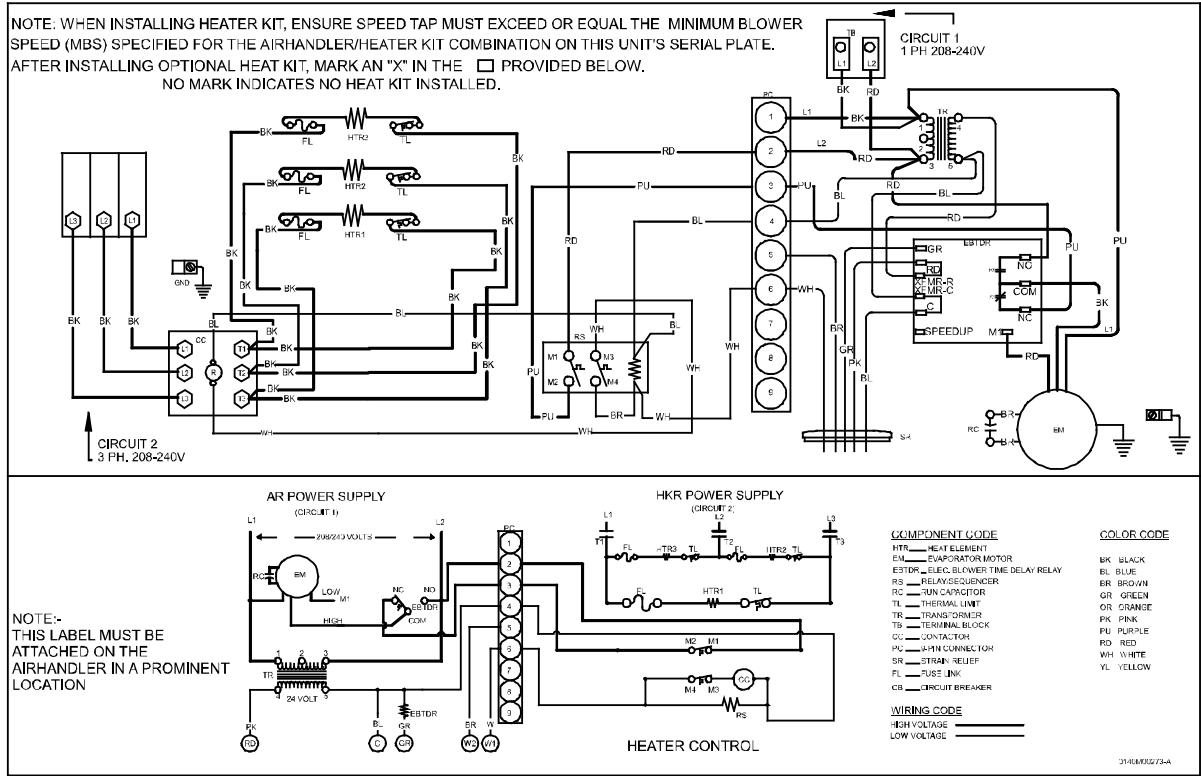

25kW Heat Kit

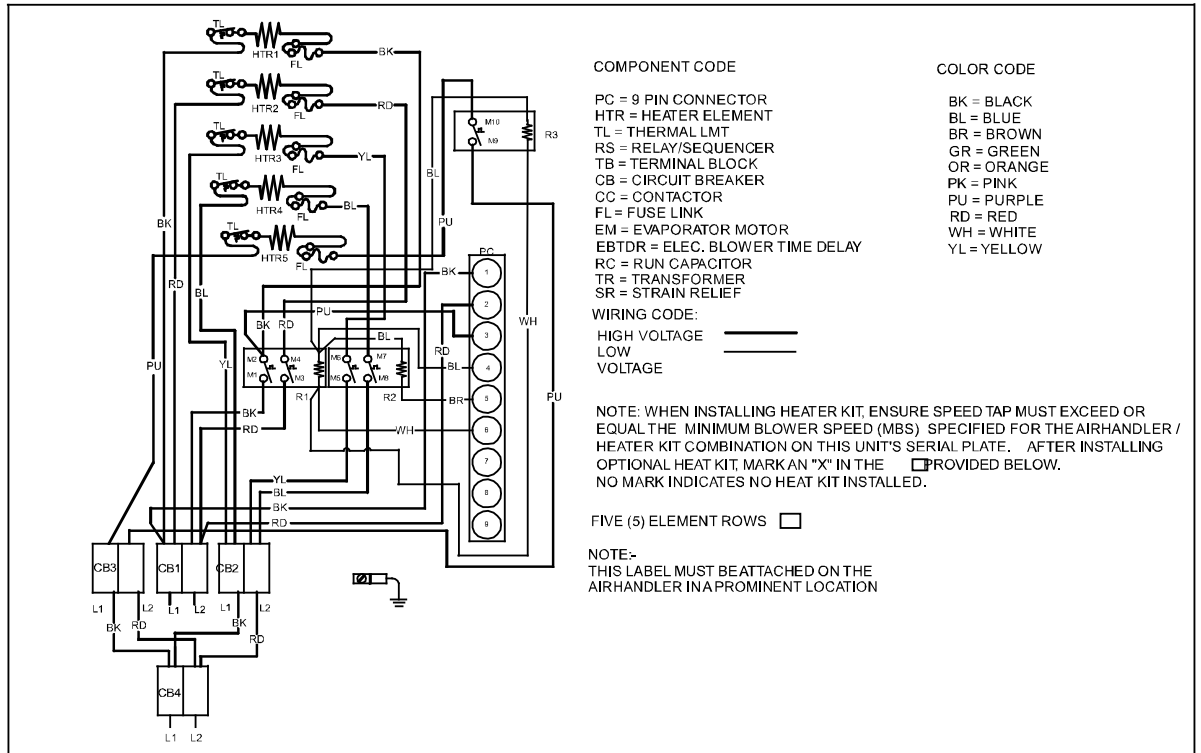

HIGH VOLTAGE!
 DISCONNECT ALL POWER BEFORE SERVICING OR INSTALLING THIS UNIT. MULTIPLE POWER SOURCES MAY BE PRESENT. FAILURE TO DO SO MAY CAUSE PROPERTY DAMAGE, PERSONAL INJURY OR DEATH.

WARNING

Wiring is subject to change. Always refer to the wiring diagram on the unit for the most up-to-date wiring.

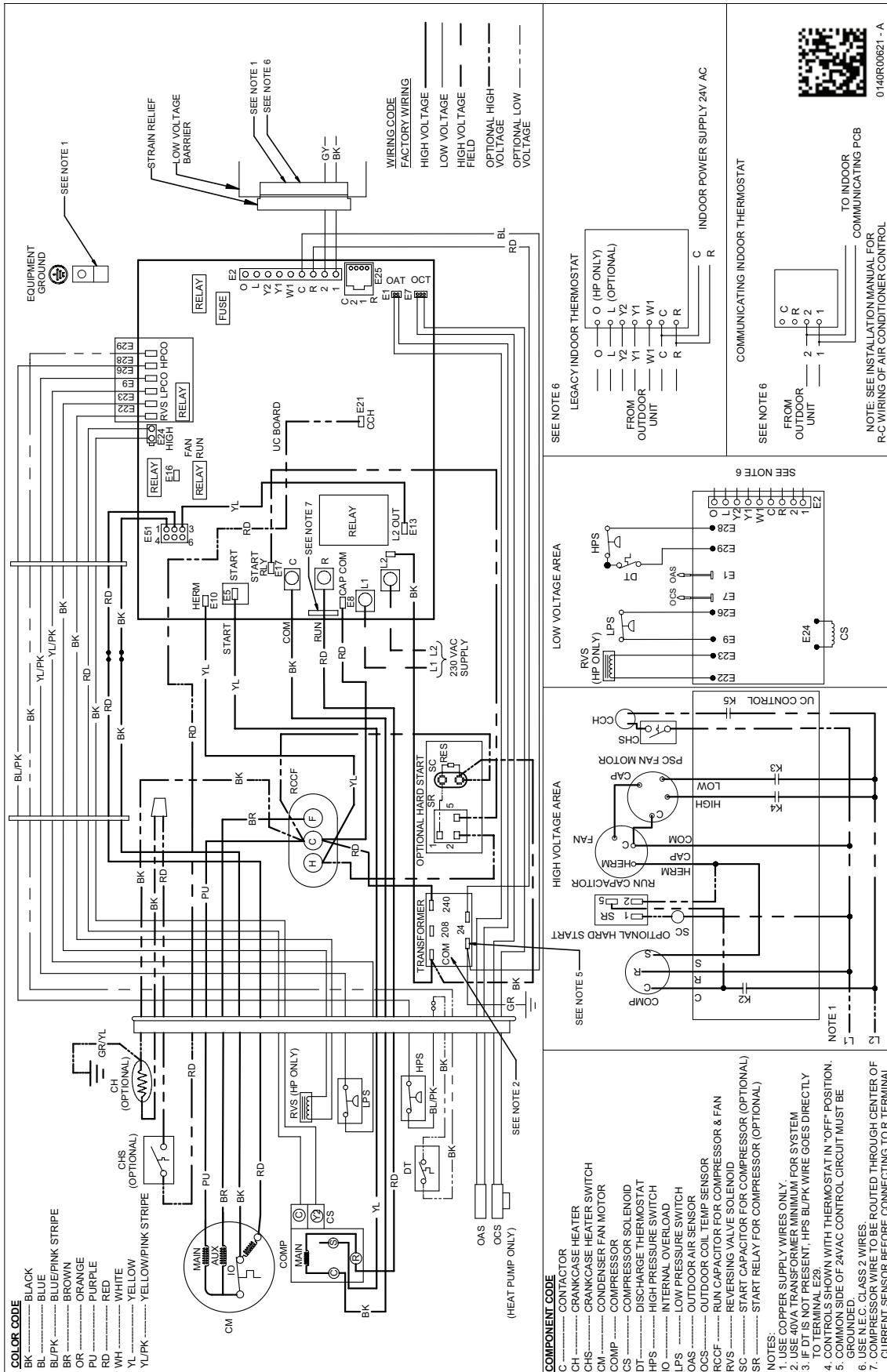
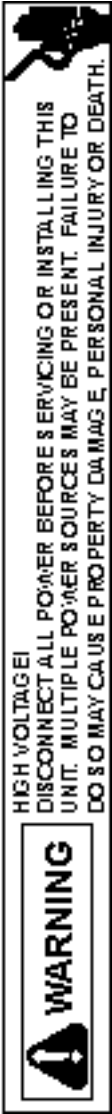

Wiring is subject to change. Always refer to the wiring diagram on the unit for the most up-to-date wiring.

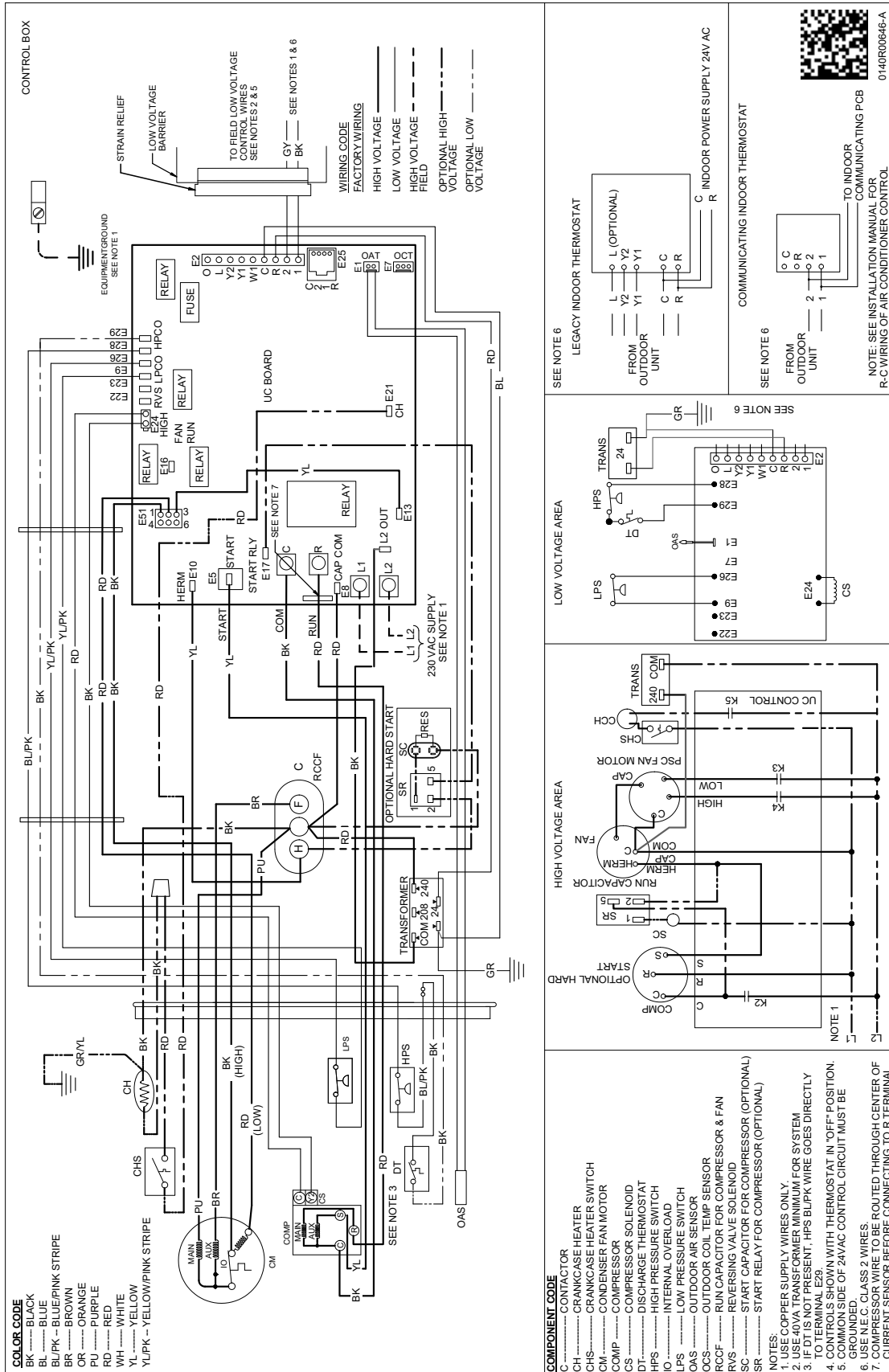
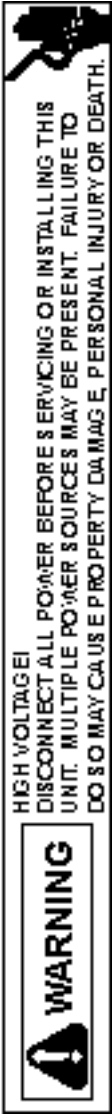

Wiring is subject to change. Always refer to the wiring diagram on the unit for the most up-to-date wiring.

WIRING DIAGRAMS

A/GSXC18 & A/GSZC18 A/GSXC16060 & A/GSZC16060

WARNING
HIGH VOLTAGE!
DISCONNECT ALL POWER BEFORE SERVICING OR INSTALLING THIS UNIT. MULTIPLE POWER SOURCES MAY BE PRESENT. FAILURE TO DO SO MAY CAUSE PROPERTY DAMAGE, PERSONAL INJURY OR DEATH.

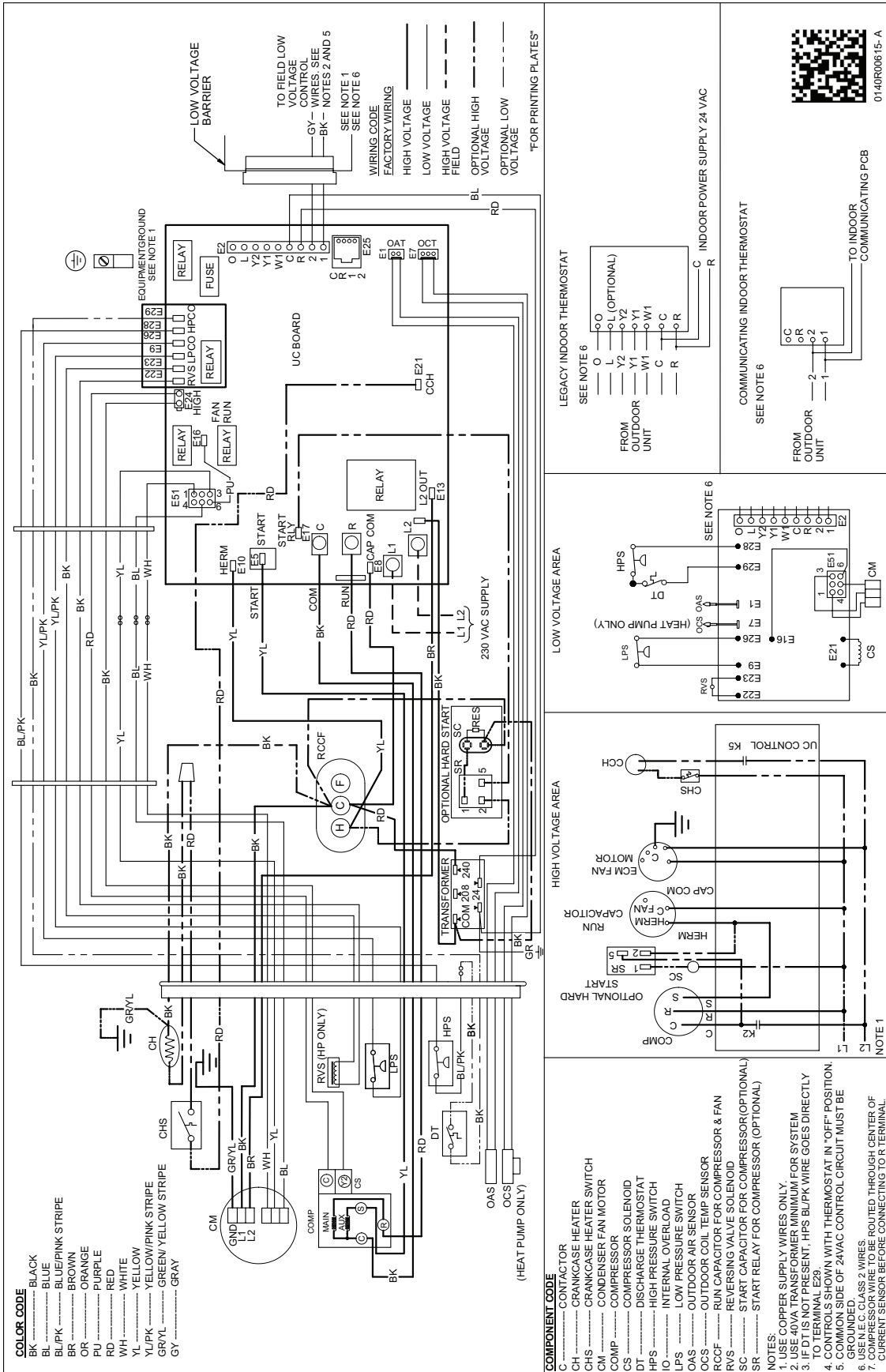

0140R00615-A

Wiring is subject to change. Always refer to the wiring diagram for the unit for the most up-to-date wiring.

WARNING

HIGH VOLTAGE!
DISCONNECT ALL POWER BEFORE SERVICING OR INSTALLING THIS UNIT. MULTIPLE POWER SOURCES MAY BE PRESENT. FAILURE TO DO SO MAY CAUSE PROPERTY DAMAGE, PERSONAL INJURY OR DEATH.

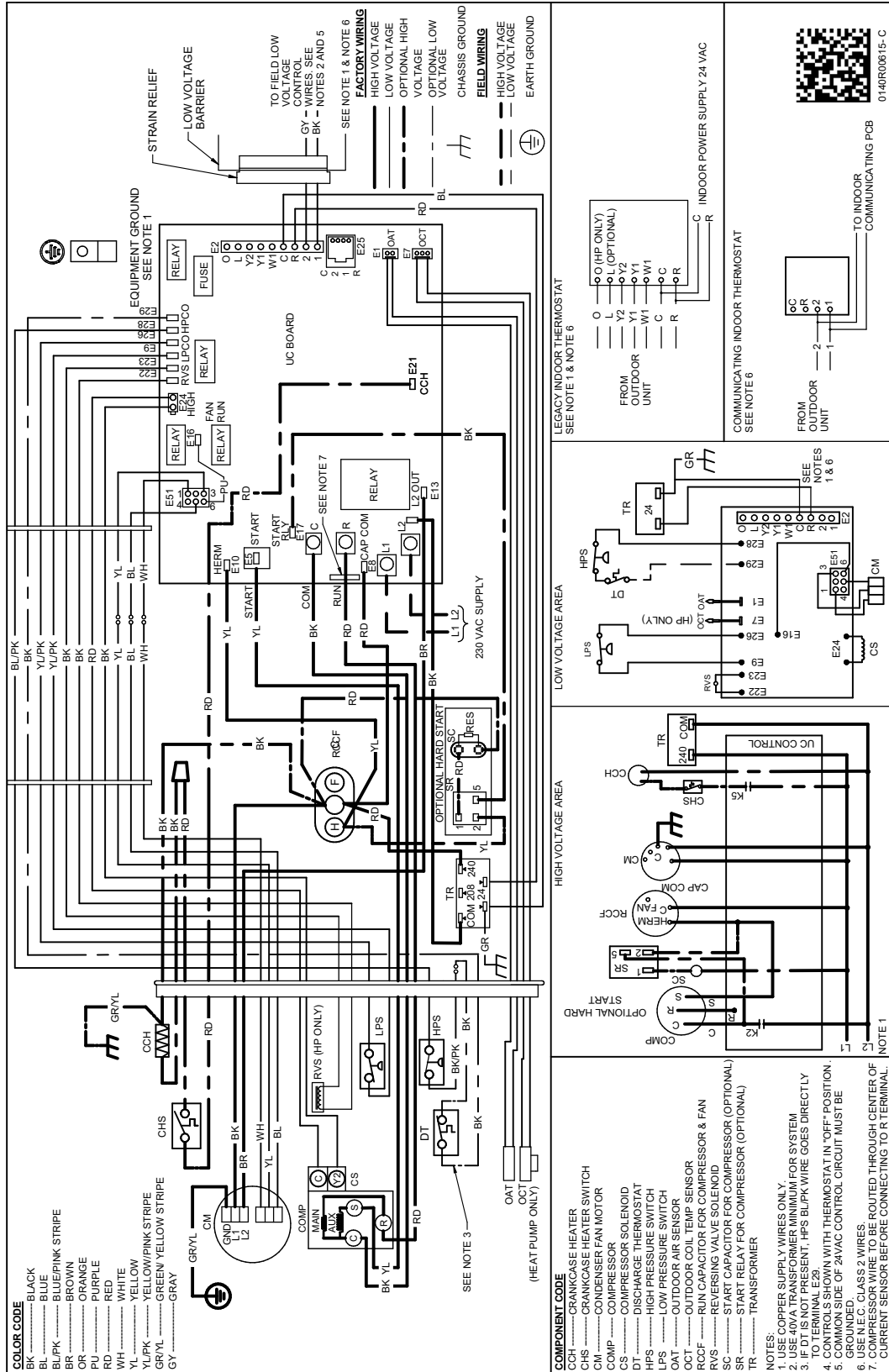

Wiring is subject to change. Always refer to the wiring diagram on the unit for the most up-to-date wiring.

WARNING

HIGH VOLTAGE!
DISCONNECT ALL POWER BEFORE SERVICING OR INSTALLING THIS UNIT. MULTIPLE POWER SOURCES MAY BE PRESENT. FAILURE TO DO SO MAY CAUSE PROPERTY DAMAGE, PERSONAL INJURY OR DEATH.

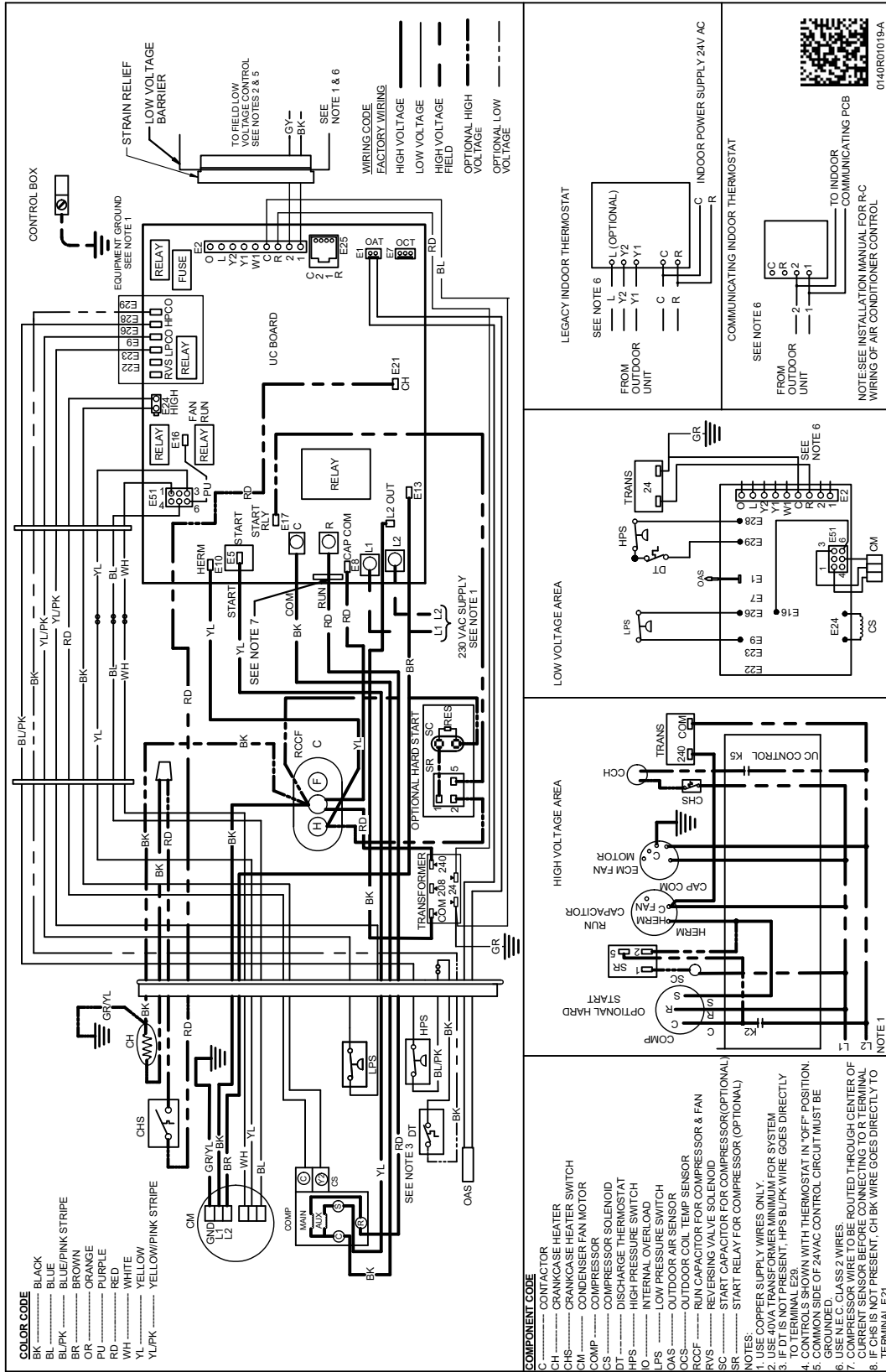

Wiring is subject to change. Always refer to the wiring diagram on the unit for the most up-to-date wiring.

WARNING

HIGH VOLTAGE!
DISCONNECT ALL POWER BEFORE SERVICING OR INSTALLING THIS UNIT. MULTIPLE POWER SOURCES MAY BE PRESENT. FAILURE TO DO SO MAY CAUSE PROPERTY DAMAGE, PERSONAL INJURY OR DEATH.

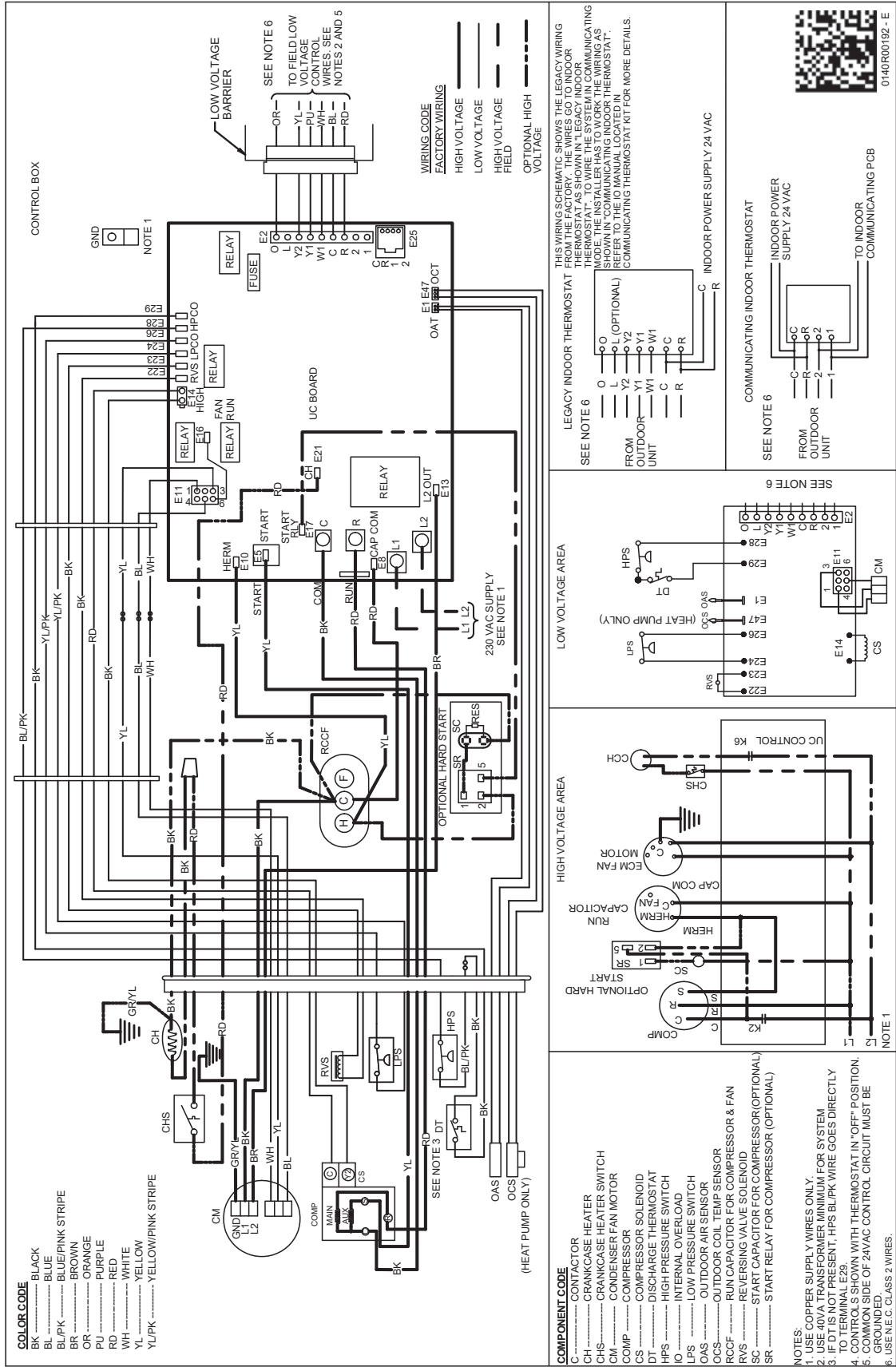

Wiring is subject to change. Always refer to the wiring diagram on the unit for the most up-to-date wiring.

WARNING

HIGH VOLTAGE!
DISCONNECT ALL POWER BEFORE SERVICING OR INSTALLING THIS UNIT. MULTIPLE POWER SOURCES MAY BE PRESENT. FAILURE TO DO SO MAY CAUSE PROPERTY DAMAGE, PERSONAL INJURY OR DEATH.

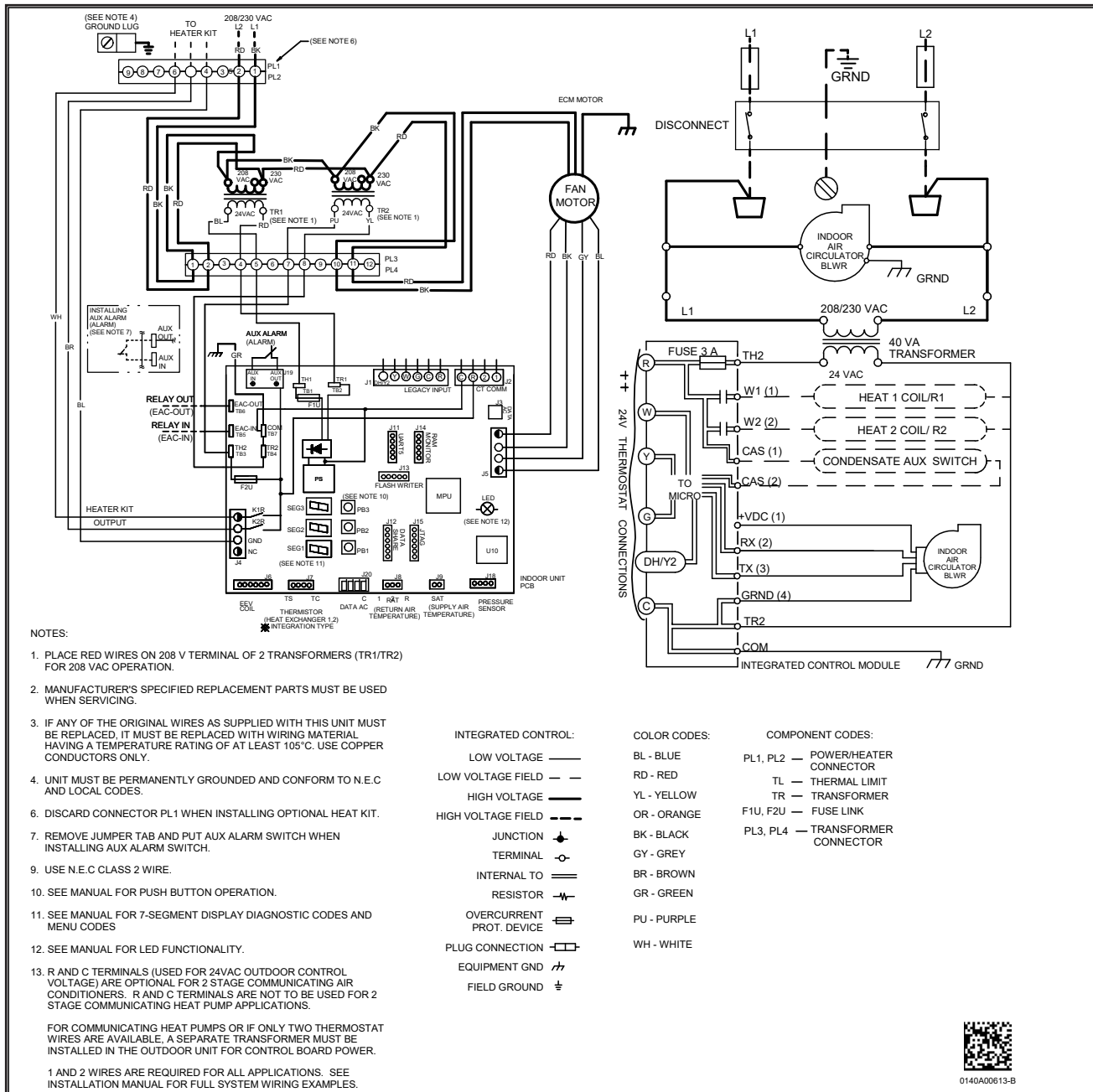

Wiring is subject to change. Always refer to the wiring diagram on the unit for the most up-to-date wiring.

WARNING

HIGH VOLTAGE!
DISCONNECT ALL POWER BEFORE SERVICING OR INSTALLING THIS UNIT. MULTIPLE POWER SOURCES MAY BE PRESENT. FAILURE TO DO SO MAY CAUSE PROPERTY DAMAGE, PERSONAL INJURY OR DEATH.

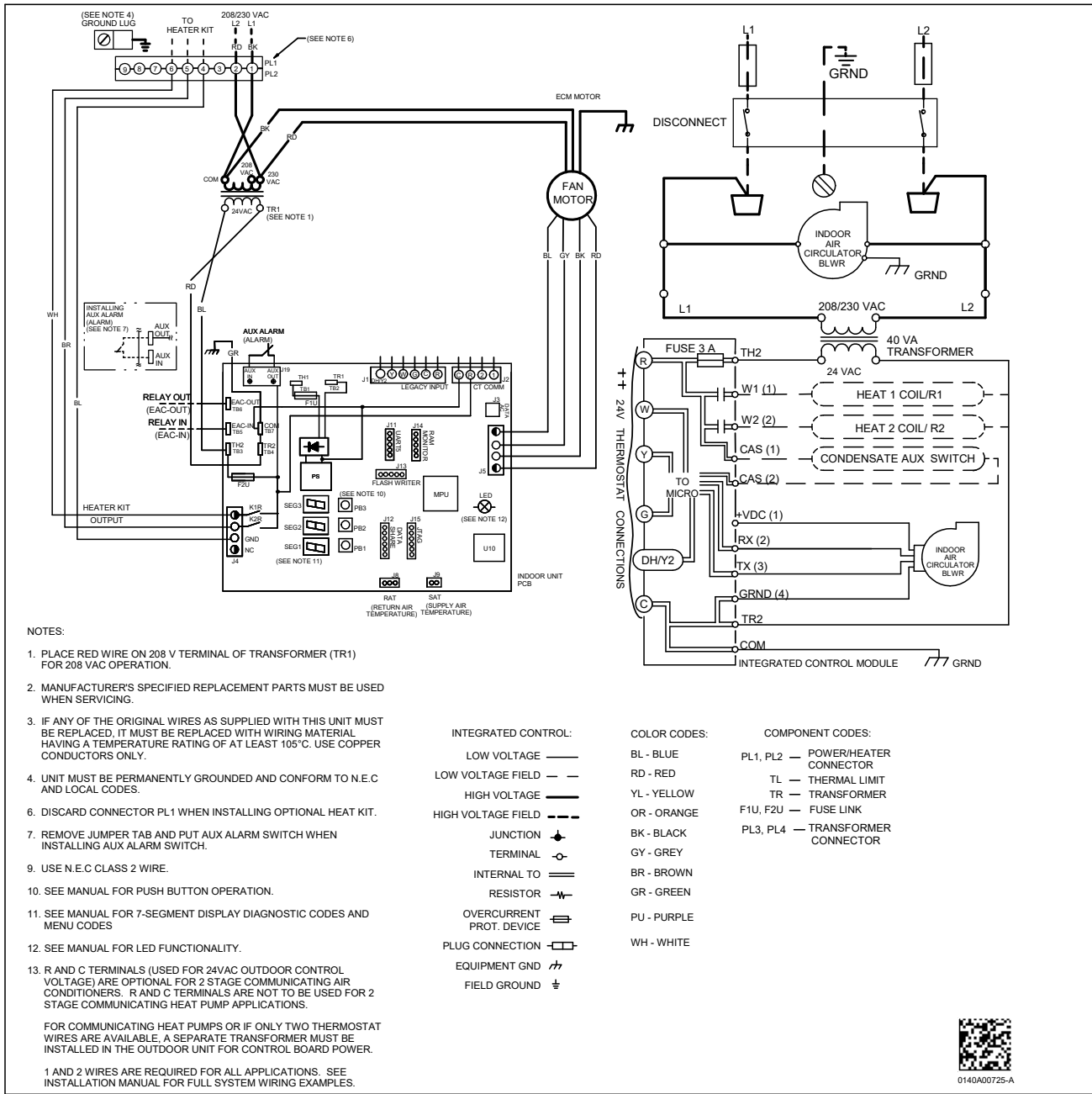

Wiring is subject to change. Always refer to the wiring diagram on the unit for the most up-to-date wiring.

WARNING

DISCONNECT ALL POWER BEFORE SERVICING OR INSTALLING THIS UNIT. MULTIPLE POWER SOURCES MAY BE PRESENT. FAILURE TO DO SO MAY CAUSE PROPERTY DAMAGE, PERSONAL INJURY OR DEATH.

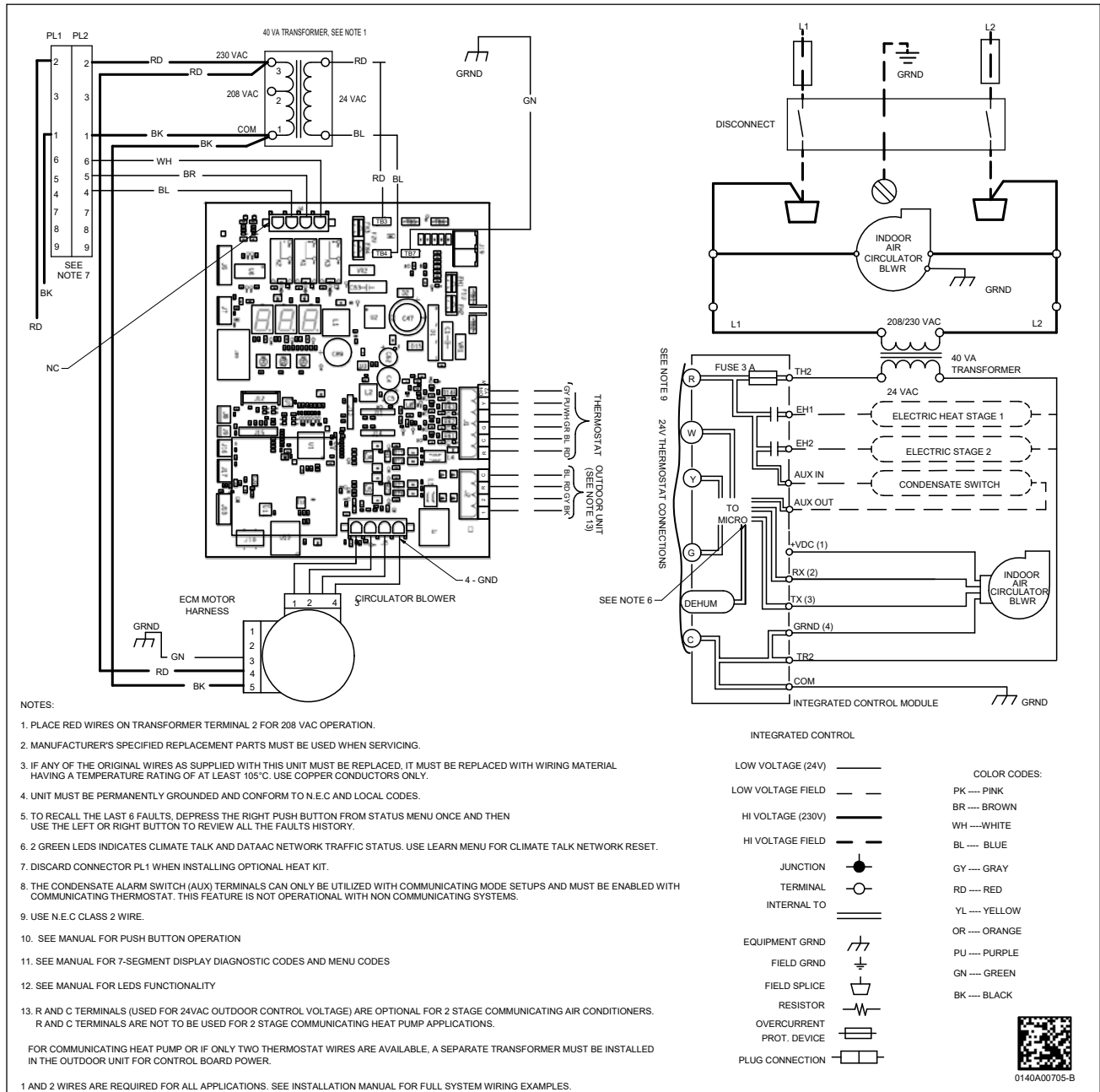

Wiring is subject to change. Always refer to the wiring diagram on the unit for the most up-to-date wiring.